**TRAINING AND QUALIFICATION -
INDIVIDUAL WEAPONS**

July 2019

DISTRIBUTION RESTRICTION: Approved for public release; distribution is unlimited.

Headquarters, Department of the Army

This publication is available at the Army Publishing Directorate site (<https://armypubs.army.mil>), and the Central Army Registry site (<https://atiam.train.army.mil/catalog/dashboard>).

Change 1

Headquarters
Department of the Army
Washington, DC, 04 November 2019

Training and Qualification – Individual Weapons

1. Change TC 3-20.40, 30 July 2019, as follows:

Remove old pages:

i through xxiii
1-21 through 1-22
4-33 through 4-34
4-47 through 4-48
B-3 through B-23
C-13 through C-14
D-3 through D-4
D-59 through D-60
E-3 through E-4
F-3 through F-4
F-69 through F-70
G-1 through G-4
H-3 through H-4
H-21 through H-32
H-43 through H-54
H-65 through H-68
H-71 through H-74
I-1 through I-4
References-3

Insert new pages:

i through xxiii
1-21 through 1-22
4-33 through 4-34
4-47 through 4-48
B-3 through B-23
C-13 through C-14
D-3 through D-4
D-59 through D-60
E-3 through E-4
F-3 through F-4
F-69 through F-70
G-1 through G-4
H-3 through H-4
H-21 through H-32
H-43 through H-54
H-65 through H-68
H-71 through H-74
I-1 through I-4
References-3

2. A bar (|) marks new or changed material.
3. File this transmittal sheet in front of the publication.

DISTRIBUTION RESTRICTION: Approved for public release; distribution is unlimited.

TC 3-20.40, C1
04 November 2019

By Order of the Secretary of the Army:

JAMES C. MCCONVILLE
General, United States Army
Chief of Staff

Official:

KATHLEEN S. MILLER
Administrative Assistant
to the Secretary of the Army
1929014

DISTRIBUTION:

Active Army, Army National Guard, and United States Army Reserve: To be distributed in accordance with the initial distribution number (IDN) 116093, requirements for TC 3-20.40.

PIN: 205399-001

Training and Qualification - Individual Weapons

Contents

| | Page |
|---|--------------|
| PREFACE | xxv |
| INTRODUCTION | xxvii |
| Chapter 1 INDIVIDUAL WEAPONS TRAINING | 1-1 |
| Strategy Principles | 1-1 |
| Strategy Structure | 1-3 |
| Tables | 1-4 |
| Training Strategy Execution | 1-12 |
| Individual Weapons Qualification Standards | 1-19 |
| Individual Weapon Validation | 1-21 |
| Certifications | 1-22 |
| Chapter 2 UNIT TRAINING PLANS | 2-1 |
| Marksmanship Master Trainer | 2-1 |
| Unit Training Plans at Echelon | 2-4 |
| Commander's Assessment | 2-5 |
| Command Training Guidance | 2-8 |
| Training Goals | 2-8 |
| Training Horizon | 2-9 |
| Chapter 3 RANGE REQUIREMENTS | 3-1 |
| Determine Range Facility | 3-1 |
| Targetry, Instrumentation, and Accessories | 3-4 |
| Sniper Specific Items | 3-15 |
| Proofing the Range | 3-18 |
| Chapter 4 RANGE OPERATIONS | 4-1 |
| Planning Live-Fire Ranges | 4-1 |
| Range Support Personnel | 4-11 |
| Preparing for Live-Fire Ranges | 4-36 |
| Execution | 4-40 |
| Assess | 4-48 |
| Appendix A AMMUNITION | A-1 |
| Appendix B FORMS | B-1 |
| Appendix C WEAPONS SAFETY | C-1 |

Contents

| | | |
|------------|--------------------------------|--------------|
| Appendix D | PISTOL | D-1 |
| Appendix E | RIFLE AND CARBINE..... | E-1 |
| Appendix F | AUTOMATIC RIFLE | F-1 |
| Appendix G | SNIPER | G-1 |
| Appendix H | URBAN RIFLE MARKSMANSHIP | H-1 |
| Appendix I | ASSISTED NIGHT FIRE | I-1 |
| | GLOSSARY | Glossary-1 |
| | REFERENCES | References-1 |
| | INDEX | Index-1 |

Figures

| | |
|--|------|
| Figure 3-1. Troop and unarmored targetry to ammunition capabilities reference | 3-13 |
| Figure 3-2. Example of the Army standard barricade for live-fire | 3-15 |
| Figure 3-3. Sniper multistory, multi-environment firing platform, example | 3-17 |
| Figure 3-4. Proofing stationary Infantry target example | 3-20 |
| Figure 3-5. Target visibility proofing example, thermal weapon sight versus E-type target | 3-21 |
| Figure 4-1. Range sketch example | 4-9 |
| Figure 4-2. Small arms range operations control area facilities, example | 4-38 |
| Figure 4-3. Concurrent training plan, example | 4-40 |
| Figure A-1. North Atlantic Treaty Organization compatibility markings example | A-2 |
| Figure A-2. Small- and medium-caliber ammunition type markings example | A-2 |
| Figure A-3. Packaging markings example | A-3 |
| Figure A-4. Lot number example | A-4 |
| Figure A-5. Lot number character position reference card | A-5 |
| Figure A-6. Lot number manufacturer's identification code example | A-6 |
| Figure A-7. Lot number year of production example | A-7 |
| Figure A-8. Lot number month of production example | A-8 |
| Figure A-9. Lot number lot interfix number example | A-9 |
| Figure A-10. Lot number lot identifier code example | A-10 |
| Figure A-11. Lot number lot sequence number example | A-11 |
| Figure A-12. Lot number lot suffix code example | A-12 |
| Figure A-13. Lot number ammunition lot theater indicators example | A-13 |
| Figure A-14. National stock number reference card | A-15 |
| Figure A-15. Department of Defense identification code reference card | A-16 |
| Figure A-16. Department of defense ammunition code example | A-16 |
| Figure A-17. Service small arms color coding with packaging markings example | A-20 |
| Figure A-18. Training unique munitions color identification and packaging markings example | A-21 |
| Figure A-19. Tier 2 ammunition letter, marking, or symbol common color standard examples | A-22 |

Figure A-20. Tier 2 ammunition color markings exampleA-22

Figure A-21 Example of ammunition placardsA-26

Figure A-22. Identify suspended or restricted ammunition flow chart exampleA-28

Figure B-1. DA Form 5517 (Standard Range Card) exampleB-3

Figure B-2. DA Form 7636 (Sniper Target Data Sheet Moving Target) exampleB-5

Figure B-3. DA Form 7637 (Sniper’s Range Card) exampleB-6

Figure B-4. DA Form 7638 (Military Sketch Panoramic and Topographic Views) exampleB-8

Figure B-5. DA Form 7651 (Sniper Target Data Sheet Stationary Target) exampleB-9

Figure B-6. Completed DA Form 7815 (Weapons Training Roll Up) exampleB-11

Figure B-7. Completed DA Form 7814 (Pistol Scorecard), exampleB-13

Figure B-8. Completed DA Form 7821 (Pistol Validation Scorecard), exampleB-14

Figure B-9. Completed DA Form 7822 (Rifle and Carbine Validation Scorecard) exampleB-16

Figure B-10. Completed DA Form 7489 (Night Fire, Assisted, Rifle Marksmanship Scorecard) exampleB-18

Figure B-11. Completed DA Form 7801, page 1 (Rifle, Carbine, and Automatic Rifle Marksmanship Scorecard) exampleB-20

Figure B-12. Completed DA Form 7801, page 2 (Rifle, Carbine, and Automatic Rifle Marksmanship Scorecard) exampleB-20

Figure B-13. Completed DA Form 7811 (Sniper Scorecard) exampleB-22

Figure B-14. Completed DA Form 7819 (Urban Marksmanship Scorecard) exampleB-23

Figure C-1. Pistol, green weapon safety status C-4

Figure C-2. Pistol, amber weapon safety status C-5

Figure C-3. Pistol, red weapon safety status C-6

Figure C-4. Pistol, black weapon safety status C-7

Figure C-5. M4- / M16-series / sniper weapons, green weapon safety status C-8

Figure C-6. M4- / M16-series / sniper weapons, amber weapon safety status C-9

Figure C-7. M4- / M16-series / sniper weapons, red weapon safety status C-10

Figure C-8. M4- / M16-series / sniper weapons, black weapon safety status C-11

Figure C-9. M249 automatic rifle, green weapon safety status C-12

Figure C-10. M249 automatic rifle, amber weapon safety status C-13

Figure C-11. M249 automatic rifle, red weapon safety status C-14

Figure C-12. M249 automatic rifle, black weapon safety status C-15

Figure D-1. Pistol, Table IV, target requirements example D-15

Figure D-2. Table V, authorized target types D-27

Figure D-3. Table VI, authorized target types D-39

Figure D-4. Table VI, Qualification, CBRN, authorized targets D-51

Figure D-5. E-type target D-59

Figure D-6. B1 target information D-66

Figure E-1. Rifle and carbine, Table IV, target requirements exampleE-19

Figure E-2. Rifle and carbine, Table IV, stages 1 and 2, target requirements exampleE-20

Figure E-3. Rifle and Carbine, Table IV, standardsE-23

Figure E-4. Rifle and carbine group 1E-24

Contents

| | |
|--|-------|
| Figure E-5. Rifle and carbine group 1 grouping standard determination | E-25 |
| Figure E-6. Rifle and carbine group 2 | E-26 |
| Figure E-7. Rifle and carbine group 2 standard determination | E-27 |
| Figure E-8. Rifle and carbine group 3 | E-28 |
| Figure E-9. Rifle and carbine group 3 grouping standard determination | E-29 |
| Figure E-10. Rifle and carbine group 3 mean point of impact determination | E-30 |
| Figure E-11. Rifle and carbine mean point of impact adjustment determination | E-31 |
| Figure E-12. Rifle and carbine mean point of impact adjustment | E-32 |
| Figure E-13. Rifle and carbine zero group 1 | E-33 |
| Figure E-14. Rifle and carbine zero group 1 standard determination | E-34 |
| Figure E-15. Rifle and carbine zero group 1 mean point of impact determination | E-35 |
| Figure E-16. Rifle and carbine mean point of impact adjustment determination | E-36 |
| Figure E-17. Rifle and carbine mean point of impact adjustment application | E-37 |
| Figure E-18. Rifle and carbine zero group 2 | E-38 |
| Figure E-19. Rifle and carbine zero group 3 | E-39 |
| Figure E-20. Rifle and carbine zero standard achieved | E-40 |
| Figure E-21. Table V, authorized target types | E-56 |
| Figure E-22. Table VI, authorized target types | E-76 |
| Figure E-23. Rifle and carbine, validation target information and placement | E-117 |
| Figure F-1. Automatic rifle, Table IV, target requirements example | F-18 |
| Figure F-2. Automatic rifle, Table IV, target requirements example | F-19 |
| Figure F-3. Automatic rifle, Table IV standards | F-22 |
| Figure F-4. Automatic rifle, group 1 | F-23 |
| Figure F-5. Automatic rifle group 1 grouping standard determination | F-24 |
| Figure F-6. Automatic rifle group 2 | F-25 |
| Figure F-7. Automatic rifle group 2 grouping standard determination | F-26 |
| Figure F-8. Automatic rifle group 3 | F-27 |
| Figure F-9. Automatic rifle group 3 grouping standard determination | F-28 |
| Figure F-10. Automatic rifle group 3 mean point of impact determination | F-29 |
| Figure F-11. Automatic rifle mean point of impact adjustment determination | F-30 |
| Figure F-12. Automatic rifle mean point of impact adjustment application | F-31 |
| Figure F-13. Automatic rifle zero group 1 | F-32 |
| Figure F-14. Automatic rifle zero group 1 grouping standard determination | F-33 |
| Figure F-15. Automatic rifle zero group 1 mean point of impact determination | F-34 |
| Figure F-16. Automatic rifle mean point of impact adjustment determination | F-35 |
| Figure F-17. Automatic rifle mean point of impact adjustment application | F-36 |
| Figure F-18. Automatic rifle zero group | F-37 |
| Figure F-19. Automatic rifle zero group 3 | F-38 |
| Figure F-20. Automatic rifle zero standard achieved | F-39 |
| Figure F-21. Table V, authorized target types | F-55 |
| Figure F-22. Table VI, authorized target types | F-75 |

Figure G-1. Sniper Rifle, Table IV, target requirements example G-17

Figure G-2. Sniper Rifle, Table IV target requirements example G-18

Figure G-3. Sniper Rifle, Table IV, target requirements example G-19

Figure G-4. Sniper rifle shot group and zeroing standard G-22

Figure G-5. Multistory, multi-environment firing platform established firing positions example . G-47

Figure G-6. Authorized target types G-48

Figure G-7. Authorized targets, frontal types G-49

Figure G-8. Authorized targets, flank types G-50

Figure G-9. Multistory, multi-environment firing platform established firing positions example . G-89

Figure G-10. Authorized target types G-90

Figure G-11. Authorized targets, frontal types G-91

Figure G-12. Authorized targets, flank types G-92

Figure H-1. Urban Rifle Marksmanship, Table IV target requirements example H-16

Figure H-2. Target emplacement with engagement distances example H-17

Figure H-3. Shot placement requirements example H-19

Figure H-4. Table V target requirements example H-38

Figure H-5. Target emplacement with engagement distances example H-40

Figure H-6. Shot placement requirements example H-42

Figure H-7. Urban Rifle Marksmanship, Table VI, targetry example H-59

Figure H-8. Target emplacement with engagement distances example H-60

Figure H-9. Shot placement requirements example H-62

Figure I-1. Assisted Night Fire, Table IV, target requirements example I-19

Figure I-2. Assisted Night Fire, Table IV, target placement requirements example I-20

Figure I-3. Table V, authorized target types I-38

Figure I-4. Table VI, authorized target types I-60

Tables

Table 1-1. Integrated weapons training strategy structure 1-4

Table 1-2. Standard individual, crew-served, and special purpose weapons training table structure
..... 1-5

Table 1-3. Integrated weapons training strategy weapons categories 1-6

Table 1-4. Individual weapons 1-7

Table 1-5. Rifle and carbine, qualification and certification use of stages and phases, example 1-8

Table 1-6. Crew-served weapons examples 1-9

Table 1-7. Heavy machine gun, Table VI, Qualification, use of stages and phases, example ... 1-10

Table 1-8. Special purpose weapons examples 1-10

Table 1-9. Shoulder launched munitions, Table VI, Qualification, use of stages and phases,
example 1-12

Table 1-10. Individual weapons drills crosswalk 1-14

Table 1-11. Prerequisites round-robin example 1-15

Contents

| | |
|---|------|
| Table 1-12. Live-fire events using a single range on one training day example | 1-18 |
| Table 1-13. Army-standard individual weapon, Table VI, Qualification requirements | 1-19 |
| Table 1-14. Common individual weapons certification examples | 1-23 |
| Table 2-1. T-21 through T-13 Planning considerations | 2-11 |
| Table 2-2. T-12 Planning considerations | 2-12 |
| Table 2-3. T-11 Planning considerations | 2-13 |
| Table 2-4. T-10 Planning considerations | 2-14 |
| Table 2-5. T-9 Planning considerations | 2-15 |
| Table 2-6. T-8 Planning considerations | 2-16 |
| Table 2-7. T-7 Planning considerations | 2-17 |
| Table 2-8. T-6 Planning considerations | 2-18 |
| Table 2-9. T-5 Planning considerations | 2-19 |
| Table 2-10. T-4 Planning considerations | 2-20 |
| Table 2-11. T-3 Planning considerations | 2-21 |
| Table 2-12. T-2 Planning considerations | 2-22 |
| Table 2-13. T-1 Planning considerations | 2-23 |
| Table 2-14. T-Week Planning considerations | 2-24 |
| Table 2-15. T+1 Planning considerations | 2-26 |
| Table 3-1. Individual weapons training strategy primary and alternate range facilities | 3-2 |
| Table 3-2. Individual weapons certification to range facility matrix | 3-3 |
| Table 3-3. Individual weapon range facility targetry capabilities matrix | 3-7 |
| Table 3-4. Stationary armored and unarmored target requirements | 3-8 |
| Table 3-5. Point troop target requirements | 3-9 |
| Table 3-6. Moving armored and unarmored target requirements | 3-10 |
| Table 3-7. Moving or evasive troop target requirements | 3-11 |
| Table 3-8. Threat vehicle immobilization zones for advanced individual weapons training and certification | 3-14 |
| Table 4-1. Small arms live-fire range planning considerations, example | 4-2 |
| Table 4-2. Environmental consideration examples | 4-4 |
| Table 4-3. Primary, alternate, and certification capable range facilities | 4-6 |
| Table 4-4. Small arms range throughput calculation example | 4-7 |
| Table 4-5. Unit GUNSOP topic reference and development example | 4-11 |
| Table 4-6. Common range support personnel structure example | 4-12 |
| Table 4-7. Individual, crew-served, and special purpose weapons minimum officer in charge appointment requirements | 4-14 |
| Table 4-8. Range officer in charge responsibilities, example | 4-15 |
| Table 4-9. Individual, crew-served, and special purpose weapons minimum range safety officer appointment requirements | 4-16 |
| Table 4-10. Range safety officer responsibilities, example | 4-17 |
| Table 4-11. Range safety officer critical tasks example | 4-18 |
| Table 4-12. Medical personnel requirements | 4-19 |
| Table 4-13. Medical support personnel responsibilities, example | 4-20 |

Table 4-14. Medical supplies and equipment for small arms ranges example 4-21

Table 4-15. Warrior aid and litter kit additional medical equipment for small arms ranges example
..... 4-22

Table 4-16. Noncommissioned officer in charge responsibilities, example 4-23

Table 4-17. Marksmanship master trainer responsibilities example 4-24

Table 4-18. Range equipment common requirements (range box) example 4-25

Table 4-19. Lane trainer(s) responsibilities example 4-26

Table 4-20. Briefing noncommissioned officer responsibilities example 4-27

Table 4-21. Common range status terms example 4-28

Table 4-22. Radio-telephone operator responsibilities example 4-29

Table 4-23. Ammunition noncommissioned officer and detail, responsibilities example 4-30

Table 4-24. Ammunition critical tasks and inspection criteria, example 4-31

Table 4-25. Ammunition issue point requirements 4-32

Table 4-26. Lane safeties responsibilities example 4-34

Table 4-27. Target noncommissioned officer and detail responsibilities example 4-35

Table 4-28. Firefighting detail responsibilities example 4-35

Table 4-29. Guard or barrier noncommissioned officer responsibilities example 4-36

Table 4-30. Typical opening information, example 4-42

Table 4-31. Occupation, hot time, and first round downrange, example 4-45

Table 4-32. Range closure entries, example 4-48

Table A-1. Federal supply classification A-14

Table A-2. Department of Defense standard ammunition color coding, special band markings A-17

Table A-3. Department of Defense standard ammunition color coding A-18

Table A-4. Ammunition color code exemptions A-19

Table B-1. Individual weapon training required Department of the Army forms B-2

Table C-1. General safe condition of the weapon for each weapons safety status C-3

Table C-2. Weapon control status C-16

Table D-1. Individual weapons training strategy structure D-1

Table D-2. Pistol individual weapon training strategy ammunition requirements D-2

Table D-3. Pistol, Table I, Preliminary Marksmanship Instruction and Evaluation D-3

Table D-4. Training event design template for Pistol, Table I D-4

Table D-5. Pistol Table I, Preliminary Marksmanship Instruction and Evaluation training plan ... D-5

Table D-6. Pistol, Table II, Preliminary-Live-Fire Simulations D-6

Table D-7. Training event design template for Pistol, Table II, Preliminary Live-Fire Simulations
..... D-7

Table D-8. Annual simulations authorizations table D-7

Table D-9. Pistol, Table II, primary and alternate authorized systems D-8

Table D-10. Pistol simulations training plan D-9

Table D-11. Pistol, Table III, Drills D-9

Table D-12. Training event design template for Pistol, Table III, Drills D-10

Table D-13. Pistol, Table III, Drills individual training plan D-11

Table D-14. Pistol, Table IV, Basic (Grouping) D-12

Contents

| | |
|--|------|
| Table D-15. Training event design template for Pistol, Table IV, Basic (Grouping) | D-12 |
| Table D-16. Table IV, Grouping ammunition authorizations | D-13 |
| Table D-17. Pistol, Table IV, Ammunition breakdown per firer | D-13 |
| Table D-18. Pistol Table IV, Basic (Grouping) authorized range facilities and targetry | D-14 |
| Table D-19. Pistol, Table IV, firing sequence example | D-16 |
| Table D-20. Table IV, New Firing Order, conduct of the range example | D-17 |
| Table D-21. Table IV, Engagement 1, first shot group, conduct of fire example | D-18 |
| Table D-22. Table IV, Engagement 2, second shot group, conduct of fire example | D-19 |
| Table D-23. Table IV, Engagement 3, third shot group, conduct of fire example | D-20 |
| Table D-24. Table IV, Engagement 4, fourth shot group, conduct of fire example | D-21 |
| Table D-25. Table IV, Engagement 5, fifth shot group, conduct of fire example | D-22 |
| Table D-26. Table IV, Completed Firing Order, conduct of the range example | D-23 |
| Table D-27. Pistol, Table V, Practice | D-24 |
| Table D-28. Training event design template for Pistol, Table V, Practice | D-25 |
| Table D-29. Table V, Practice ammunition requirements | D-26 |
| Table D-30. Pistol, Table V, Practice ammunition breakdown | D-26 |
| Table D-31. Pistol, Table V, Practice authorized range facilities | D-27 |
| Table D-32. Pistol Table V, Practice target engagement sequence | D-28 |
| Table D-33. Pistol, Table V, Practice engagements 10 through 17 sequence | D-29 |
| Table D-34. Pistol, Table V, Practice engagements 18 through 23 sequence | D-30 |
| Table D-35. Table V, New Firing Order, conduct of the range example | D-31 |
| Table D-36. Table V, engagement 1 through 9, conduct of fire example | D-32 |
| Table D-37. Table V, engagement 10 through 17, conduct of fire example | D-33 |
| Table D-38. Table V, engagement 18 through 23, conduct of fire example | D-34 |
| Table D-39. Table V, completed firing order, conduct of the range example | D-35 |
| Table D-40. Pistol, Table VI, Qualification | D-36 |
| Table D-41. Training event design template for Pistol, Table VI, Qualification | D-37 |
| Table D-42. Table VI, Qualification ammunition requirements | D-38 |
| Table D-43. Pistol Table VI, Qualification ammunition breakdown | D-38 |
| Table D-44. Pistol Table VI, Qualification authorized range facilities | D-38 |
| Table D-45. Pistol, Table VI, Qualification target engagement sequence | D-40 |
| Table D-46. Pistol, Table VI, Qualification, engagement 10 through 17 sequence | D-41 |
| Table D-47. Pistol, Table VI, Qualification, engagement 18 through 23 sequence | D-42 |
| Table D-48. Table VI, New Firing Order, conduct of the range example | D-43 |
| Table D-49. Table VI, engagement 1 through 9, conduct of fire example | D-44 |
| Table D-50. Table VI, engagement 10 through 17, conduct of fire example | D-45 |
| Table D-51. Table V, engagement 18 through 23, conduct of fire example | D-46 |
| Table D-52. Table VI, Completed Firing Order, conduct of the range example | D-47 |
| Table D-53. Table VI, Qualification, Chemical, Biological, Radiological, and Nuclear execution based on virtual system availability | D-48 |
| Table D-54. Pistol Table VI, Qualification, Chemical, Biological, Radiological, and Nuclear | D-48 |

| | |
|--|------|
| Table D-55. Training event design template for Pistol, Table VI, Qualification, Chemical, Biological, Radiological, and Nuclear | D-49 |
| Table D-56. Table VI, Qualification, Chemical, Biological, Radiological, and Nuclear ammunition requirements | D-50 |
| Table D-57. Pistol Table VI, Qualification, Chemical, Biological, Radiological, and Nuclear authorized range facilities | D-50 |
| Table D-58. Pistol, Table VI, Qualification, Chemical, Biological, Radiological, and Nuclear target engagement sequence | D-52 |
| Table D-59. Table VI, Chemical, Biological, Radiological, and Nuclear, new firing order conduct of the range example | D-53 |
| Table D-60. Table VI, Qualification, Chemical, Biological, Radiological, and Nuclear, conduct of fire | D-54 |
| Table D-61. Table VI, Qualification, Chemical, Biological, Radiological, and Nuclear, completed firing order, conduct of the range example | D-55 |
| Table D-62. Table VI, Qualification, Night Fire, execution based on virtual system availability | D-56 |
| Table D-63. Pistol, Table VI, Qualification, Night Fire | D-56 |
| Table D-64. Training event design template for Pistol, Table VI, Qualification, Night Fire | D-57 |
| Table D-65. Table VI, Night Fire ammunition requirements | D-58 |
| Table D-66. Pistol Table VI, Qualification, Night Fire authorized range facilities | D-58 |
| Table D-67. Pistol Table VI, Qualification, Night Fire target engagement sequence | D-59 |
| Table D-68. Table VI, Qualification, Night Fire, new firing order, conduct of the range example | D-60 |
| Table D-69. Table VI, Qualification, Night Fire engagement 1 through 4 | D-61 |
| Table D-70. Table VI, Qualification, Night Fire completed firing order, conduct of the range example | D-62 |
| Table D-71. Pistol validation task, conditions, and standard | D-63 |
| Table D-72. Training event design template for pistol validation | D-64 |
| Table D-73. Ammunition requirements by engagement | D-65 |
| Table D-74. Pistol validation authorized range facilities | D-65 |
| Table D-75. Firing position by engagement | D-67 |
| Table D-76. Alternate Course of Fire, new firing order, conduct of the range example | D-68 |
| Table D-77. Alternate Course of Fire engagement 1, conduct of fire example | D-69 |
| Table D-78. Alternate Course of Fire, engagement 2, conduct of fire example | D-70 |
| Table D-79. Alternate Course of Fire, engagement 3, conduct of fire example | D-71 |
| Table D-80. Alternate Course of Fire, completed firing order, conduct of the range example .. | D-72 |
| Table E-1. Individual weapons training strategy structure | E-1 |
| Table E-2. Rifle and carbine individual weapon training strategy ammunition requirements | E-3 |
| Table E-3. Rifle and Carbine, Table I, Preliminary Marksmanship Instruction and Evaluation | E-4 |
| Table E-4. Training event design template for Rifle and Carbine, Table I | E-5 |
| Table E-5. Rifle and Carbine, Table I, Preliminary Marksmanship Instruction and Evaluation training plan | E-6 |
| Table E-6. Rifle and Carbine, Table II, Preliminary Live-Fire Simulations | E-7 |
| Table E-7. Training event design template for rifle and carbine, Table II, Preliminary-Live-Fire Simulations | E-8 |

Contents

| | |
|--|------|
| Table E-8. Annual simulations authorizations table | E-9 |
| Table E-9. Rifle and Carbine, Table II, Primary and alternate authorized systems | E-9 |
| Table E-10. Rifle and carbine simulations training plan | E-10 |
| Table E-11. Rifle and Carbine, Table III, Drills, task, conditions, and standard | E-10 |
| Table E-12. Training event design template for rifle and carbine, Table III, Drills | E-11 |
| Table E-13. Rifle and carbine, Table III, Drills individual training plan | E-12 |
| Table E-14. Rifle and carbine, Table IV, Basic | E-13 |
| Table E-15. Training event design template for rifle and carbine, Table IV, Basic | E-14 |
| Table E-16. Table IV, Basic, primary optics | E-15 |
| Table E-17. Table IV, Basic, ammunition authorizations | E-16 |
| Table E-18. Rifle and Carbine, Table IV, ammunition breakdown, iron sights / backup iron sight per firer | E-17 |
| Table E-19. Rifle and Carbine, Table IV, ammunition breakdown, close combat optic / rifle combat optic per firer | E-17 |
| Table E-20. Rifle and carbine, Table IV, Basic authorized range facilities and targetry | E-18 |
| Table E-21. Rifle and carbine, Table IV, firing sequence example | E-21 |
| Table E-22. Shot group, grouping, and zeroing standards | E-22 |
| Table E-23. Table IV, new firing order, conduct of the range example | E-41 |
| Table E-24. Table IV, engagement 1, first shot group, conduct of fire example | E-42 |
| Table E-25. Table IV, engagement 2, second shot group, conduct of fire example | E-43 |
| Table E-26. Table IV, engagement 3, third shot group, conduct of fire example | E-44 |
| Table E-27. Table IV, engagement 4, zeroing group one, conduct of fire example | E-45 |
| Table E-28. Table IV, engagement 5, zeroing group two, conduct of fire example | E-46 |
| Table E-29. Table IV, engagement 6, zeroing group three, conduct of fire example | E-47 |
| Table E-30. Table IV, engagement 7, confirmation of distance, conduct of fire example | E-49 |
| Table E-31. Table IV, engagement 8, application of hold-offs, conduct of fire example | E-50 |
| Table E-32. Table IV, completed firing order, conduct of the range example | E-51 |
| Table E-33. Rifle and Carbine, Table V, Practice | E-52 |
| Table E-34. Training event design template for Rifle and Carbine, Table V, Practice | E-53 |
| Table E-35. Rifle and Carbine, Table V, Practice ammunition requirements | E-54 |
| Table E-36. Rifle and Carbine, Table V, Practice ammunition breakdown | E-54 |
| Table E-37. Rifle and Carbine, Table V, Practice authorized range facilities | E-55 |
| Table E-38. Rifle and carbine, Table V, Practice, engagement sequence | E-57 |
| Table E-39. Rifle and Carbine, Table V, Practice, throughput time schedule | E-61 |
| Table E-40. Table V, new firing order, conduct of the range example | E-62 |
| Table E-41. Table IV, engagement 7, confirmation at distance, conduct of fire example | E-63 |
| Table E-42. Table IV, engagement 8, application of hold-offs, conduct of fire example | E-64 |
| Table E-43. Table V, engagement 1 through 5, conduct of fire example | E-65 |
| Table E-44. Table V, engagement 6 through 10, conduct of fire example | E-66 |
| Table E-45. Table V, engagement 11 through 14, conduct of fire example | E-67 |
| Table E-46. Table V, engagement 15 through 18, conduct of fire example | E-68 |
| Table E-47. Table V, completed firing order, conduct of the range example | E-69 |

Table E-48. Rifle and Carbine, Table VI, Qualification task, conditions, and standardE-70

Table E-49. Training event design template for Rifle and Carbine, Table VI, QualificationE-71

Table E-50. Stage descriptions, Rifle and Carbine, Table VI, QualificationE-72

Table E-51. Rifle and Carbine, Table VI, Qualification ammunition requirementsE-73

Table E-52. Rifle and Carbine, Table VI, Qualification ammunition breakdownE-74

Table E-53. Rifle and Carbine, Table VI, Qualification authorized range facilitiesE-75

Table E-54. Stage 1, Day Fire, ammunition requirementsE-77

Table E-55. Rifle and Carbine, Table VI, Qualification, Stage 1, Day Fire, ammunition breakdown
.....E-77

Table E-56. Rifle and Carbine Table VI, Qualification, Stage 1, Day Fire, engagement sequence
.....E-78

Table E-57. Stage 1, Day Fire, throughput time scheduleE-82

Table E-58. Stage 1, Day Fire, and Stage 2, Day Fire, Chemical, Biological, Radiological, and
Nuclear throughput time scheduleE-83

Table E-59. Table VI, new firing order, conduct of the range exampleE-84

Table E-60. Table IV, engagement 7, confirmation at distance, conduct of fire exampleE-85

Table E-61. Table IV, engagement 8, application of hold-offs, conduct of fire exampleE-86

Table E-62. Table VI, engagement 1 through 5, conduct of fire exampleE-87

Table E-63. Table VI, engagement 6 through 10, conduct of fire exampleE-88

Table E-64. Table VI, engagement 11 through 14, conduct of fire exampleE-89

Table E-65. Table VI, engagement 15 through 18, conduct of fire exampleE-90

Table E-66. Table VI, completed firing order, conduct of the range exampleE-91

Table E-67. Stage 2, Day Fire, Chemical, Biological, Radiological, and Nuclear, training
environment requirementE-92

Table E-68. Stage 2, Day Fire, Chemical, Biological, Radiological, and Nuclear, ammunition
requirementsE-92

Table E-69. Stage 2, Day Fire, Chemical, Biological, Radiological, and Nuclear, target
engagement sequenceE-93

Table E-70. Stage 2, Day Fire, Chemical, Biological, Radiological, and Nuclear throughput time
scheduleE-94

Table E-71. Stage 2, Day Fire, Chemical, Biological, Radiological, and Nuclear, new firing order,
conduct of the range exampleE-95

Table E-72. Stage 2, Day Fire, Chemical, Biological, Radiological, and Nuclear, conduct of fire
.....E-96

Table E-73. Stage 2, Day Fire, Chemical, Biological, Radiological, and Nuclear, completed firing
order, conduct of the range exampleE-97

Table E-74. Rifle and Carbine, Table VI, Qualification, Night Fire, execution based on virtual
system availabilityE-98

Table E-75. Rifle and Carbine, Table VI, Night Fire ammunition requirementsE-98

Table E-76. Rifle and Carbine, Table VI, Qualification, Night Fire, ammunition breakdownE-98

Table E-77. Stage 3, Night Fire, target engagement sequenceE-99

Table E-78. Stage 3, Night Fire and Stage 4, Night Fire, Chemical, Biological, Radiological, and
Nuclear throughput time scheduleE-101

Table E-79. Stage 3, Night Fire, new firing order, conduct of the range exampleE-102

Contents

| | |
|--|-------|
| Table E-80. Stage 3, Night Fire engagement 1 through 6 | E-103 |
| Table E-81. Stage 3, Night Fire, completed firing order, conduct of the range example | E-105 |
| Table E-82. Stage 4, Day Fire, Chemical, Biological, Radiological, and Nuclear, training environment requirement | E-106 |
| Table E-83. Stage 4, Rifle and Carbine, Table VI, Night Fire, Chemical, Biological, Radiological, and Nuclear ammunition requirements | E-106 |
| Table E-84. Stage 4, Night Fire, Chemical, Biological, Radiological, and Nuclear ammunition breakdown | E-107 |
| Table E-85. Stage 4, Night Fire, Chemical, Biological, Radiological, and Nuclear target engagement sequence | E-108 |
| Table E-86. Stage 4, Night Fire, Chemical, Biological, Radiological, and Nuclear throughput time schedule | E-109 |
| Table E-87. Stage 4, Night Fire, Chemical, Biological, Radiological, and Nuclear, new firing order, conduct of the range example | E-110 |
| Table E-88. Stage 4, Night Fire, Chemical, Biological, Radiological, and Nuclear, completed firing order, conduct of the range example | E-112 |
| Table E-89. Rifle and Carbine Validation, task, conditions, and standard | E-113 |
| Table E-90. Training event design template for Rifle and Carbine Validation | E-114 |
| Table E-91. Rifle and Carbine, Table V, Practice ammunition requirements | E-115 |
| Table E-92. Rifle and Carbine, Validation ammunition breakdown | E-115 |
| Table E-93. Rifle and Carbine Validation authorized range facilities | E-116 |
| Table E-94. Rifle and Carbine Validation engagement sequence | E-119 |
| Table E-95. Rifle and Carbine, Table V, Practice throughput time schedule | E-120 |
| Table E-96. Alternate Course of Fire, new firing order, conduct of the range example | E-121 |
| Table E-97. Rifle and Carbine Validation, engagement 1, conduct of fire example | E-122 |
| Table E-98. Rifle and Carbine Validation, engagement 2, conduct of fire example | E-123 |
| Table E-99. Rifle and Carbine Validation, engagement 3, conduct of fire example | E-124 |
| Table E-100. Rifle and Carbine Validation, engagement 4, conduct of fire example | E-125 |
| Table E-101. Rifle and Carbine Validation, engagement 5, conduct of fire example | E-126 |
| Table E-102. Rifle and Carbine Validation, engagement 6, conduct of fire example | E-127 |
| Table E-103. Rifle and Carbine Validation, engagement 7, conduct of fire example | E-128 |
| Table E-104. Rifle and Carbine Validation, engagement 8, conduct of fire example | E-129 |
| Table E-105. Alternate course of fire, completed firing order, conduct of the range example | E-130 |
| Table F-1. Individual weapons training strategy structure | F-1 |
| Table F-2. Automatic rifle individual weapon training strategy ammunition requirements | F-2 |
| Table F-3. Automatic Rifle, Table I, Preliminary Marksmanship Instruction and Evaluation | F-3 |
| Table F-4. Training event design template for Automatic Rifle, Table I | F-4 |
| Table F-5. Automatic Rifle, Table I, Preliminary Marksmanship Instruction and Evaluation training plan | F-5 |
| Table F-6. Automatic Rifle, Table II, Preliminary-Live-Fire Simulations | F-6 |
| Table F-7. Training event design template for Automatic Rifle, Table II, Preliminary-Live-Fire Simulations | F-7 |
| Table F-8. Annual simulations authorizations table | F-8 |

Table F-9. Automatic Rifle, Table II, primary and alternate authorized systems F-8

Table F-10. Automatic rifle simulations training plan F-9

Table F-11. Automatic Rifle, Table III, Drills, task, conditions, and standards F-10

Table F-12. Training event design template for Automatic Rifle, Table III, Drills F-11

Table F-13. Automatic Rifle, Table III, Drills individual training plan F-12

Table F-14. Automatic Rifle, Table IV, Basic F-13

Table F-15. Training event design template for Automatic Rifle, Table IV, Basic F-14

Table F-16. Table IV, Basic, primary optics F-15

Table F-17. Table IV, Basic, ammunition authorizations F-15

Table F-18. Automatic Rifle, Table IV, ammunition breakdown per firer F-16

Table F-19. Automatic Rifle Table IV, Basic (Grouping) authorized range facilities and
targetry F-17

Table F-20. Automatic Rifle, Table IV, firing sequence example F-20

Table F-21. Shot group, grouping, and zeroing standards F-21

Table F-22. Table IV, new firing order, conduct of the range example F-40

Table F-23. Table IV, engagement 1, first shot group, conduct of fire example F-41

Table F-24. Table IV, engagement 2, second shot group, conduct of fire example F-42

Table F-25. Table IV, engagement 3, third shot group, conduct of fire example F-43

Table F-26. Table IV, engagement 4, group one, conduct of fire example F-44

Table F-27. Table IV, engagement 5, zeroing group two, conduct of fire example F-45

Table F-28. Table IV, engagement 6, zeroing group three, conduct of fire example F-46

Table F-29. Table IV, engagement 7, confirmation at distance, conduct of fire example F-48

Table F-30. Table IV, engagement 8, application of hold-offs, conduct of fire example F-49

Table F-31. Table IV, completed firing order, conduct of the range example F-50

Table F-32. Automatic Rifle, Table V, Practice F-51

Table F-33. Automatic Rifle, Table V, Practice ammunition requirements F-52

Table F-34. Automatic Rifle, Table V, Practice ammunition requirements F-53

Table F-35. Automatic Rifle, Table V, Practice ammunition breakdown F-53

Table F-36. Automatic Rifle, Table V, Practice authorized range facilities F-54

Table F-37. Automatic Rifle Table V, Practice, engagement sequence F-56

Table F-38. Automatic Rifle, Table V, Practice throughput time schedule F-60

Table F-39. Table V, new firing order, conduct of the range example F-61

Table F-40. Table IV, engagement 7, confirmation at distance, conduct of fire example F-62

Table F-41. Table IV, engagement 8, application of hold-offs, conduct of fire example F-63

Table F-42. Table V, engagement 1 through 5, conduct of fire example F-64

Table F-43. Table V, engagement 6 through 10, conduct of fire example F-65

Table F-44. Table V, engagement 11 through 14, conduct of fire example F-66

Table F-45. Table V, engagement 15 through 18, conduct of fire example F-67

Table F-46. Table V, completed firing order, conduct of the range example F-68

Table F-47. Automatic Rifle, Table VI, Qualification task, conditions, and standard F-69

Table F-48. Training event design template for Automatic Rifle, Table VI, Qualification F-70

Table F-49. Stage descriptions, Automatic Rifle, Table VI, Qualification F-71

Contents

| | |
|---|-------|
| Table F-50. Automatic Rifle, Table VI, Qualification ammunition requirements | F-72 |
| Table F-51. Automatic Rifle, Table VI, Qualification ammunition breakdown | F-73 |
| Table F-52. Automatic Rifle, Table VI, Qualification authorized range facilities | F-74 |
| Table F-53. Automatic Rifle, Table VI, Qualification, Stage 1, Day Fire, ammunition breakdown | F-76 |
| Table F-54. Automatic Rifle Table VI, Qualification, Stage 1, Day Fire, engagement sequence | F-77 |
| Table F-55. Stage 1, Day Fire throughput time schedule | F-81 |
| Table F-56. Stage 1, Day Fire, and Stage 2, Day Fire, Chemical, Biological, Radiological, and Nuclear throughput time schedule | F-82 |
| Table F-57. Table VI, new firing order, conduct of the range example | F-83 |
| Table F-58. Table IV, engagement 7, confirmation at distance, conduct of fire example | F-84 |
| Table F-59. Table IV, engagement 8, application of hold-offs, conduct of fire example | F-85 |
| Table F-60. Table VI, engagement 1 through 5, conduct of fire example | F-86 |
| Table F-61. Table VI, engagement 6 through 10, conduct of fire example | F-87 |
| Table F-62. Table VI, engagement 11 through 14, conduct of fire example | F-88 |
| Table F-63. Table VI, engagement 15 through 18, conduct of fire example | F-89 |
| Table F-64. Table VI, completed firing order, conduct of the range example | F-90 |
| Table F-65. Stage 2, Day Fire, Chemical, Biological, Radiological, and Nuclear, training environment requirement | F-91 |
| Table F-66. Stage 2, Day Fire, Chemical, Biological, Radiological, and Nuclear ammunition requirement | F-91 |
| Table F-67. Stage 2, Day Fire, Chemical, Biological, Radiological, and Nuclear, target engagement sequence | F-92 |
| Table F-68. Stage 2, Day Fire, Chemical, Biological, Radiological, and Nuclear throughput time schedule | F-93 |
| Table F-69. Stage 2, Day Fire, Chemical, Biological, Radiological, and Nuclear, new firing order conduct of the range example | F-94 |
| Table F-70. Stage 2, Day Fire, Chemical, Biological, Radiological, and Nuclear, conduct of fire | F-95 |
| Table F-71. Stage 2, Day Fire, Chemical, Biological, Radiological, and Nuclear, completed firing order, conduct of the range example | F-96 |
| Table F-72. Automatic Rifle, Table VI, Qualification, Night Fire, execution based on virtual system availability | F-97 |
| Table F-73. Automatic Rifle, Table VI, Night Fire ammunition requirements | F-97 |
| Table F-74. Stage 3, Night Fire, target engagement sequence | F-98 |
| Table F-75. Stage 3, Night Fire and Stage 4, Night Fire, Chemical, Biological, Radiological, and Nuclear throughput time schedule | F-100 |
| Table F-76. Stage 3, Night Fire, new firing order, conduct of the range example | F-101 |
| Table F-77. Stage 3, Night Fire engagement 1 through 6 | F-102 |
| Table F-78. Stage 3, Night Fire, completed firing order, conduct of the range example | F-104 |
| Table F-79. Stage 4, Day Fire, Chemical, Biological, Radiological, and Nuclear, training environment requirement | F-105 |
| Table F-80. Stage 4, Automatic Rifle, Table VI, Night Fire, Chemical, Biological, Radiological, and Nuclear ammunition requirements | F-105 |

Table F-81. Stage 4, Night Fire, Chemical, Biological, Radiological, and Nuclear target engagement sequenceF-106

Table F-82. Stage 4, Night Fire, Chemical, Biological, Radiological, and Nuclear, standing, unsupportedF-107

Table F-83. Stage 4, Night Fire, Chemical, Biological, Radiological, and Nuclear, new firing order, conduct of the range exampleF-108

Table F-84. Stage 4, Night Fire, Chemical, Biological, Radiological, and Nuclear, completed firing order, conduct of the range exampleF-110

Table G-1. Individual weapons training strategy structure G-1

Table G-2. Sniper rifle individual weapon training strategy ammunition requirements G-2

Table G-3. Sniper Rifle, Table I, Preliminary Marksmanship Instruction and Evaluation G-3

Table G-4. Training event design template for Sniper Rifle, Table I G-4

Table G-5. Sniper Rifle, Table I, Preliminary Marksmanship Instruction and Evaluation training plan G-5

Table G-6. Sniper Rifle, Table II, Preliminary-Live-Fire Simulations G-6

Table G-7. Training event design template for Sniper Rifle, Table II, Preliminary-Live-Fire Simulations G-7

Table G-8. Simulations authorizations table G-7

Table G-9. Sniper Rifle, Table II, primary and alternate authorized systems G-8

Table G-10. Sniper rifle simulations training plan G-9

Table G-11. Sniper Rifle, Table III, Drills, task, conditions, and standard G-10

Table G-12. Training event design template for Sniper Rifle, Table III, Drills G-11

Table G-13. Sniper Rifle, Table III, Drills individual training plan G-12

Table G-14. Sniper Rifle, Table IV, Basic G-13

Table G-15. Training event design template for Sniper Rifle, Table IV, Basic G-14

Table G-16. Table IV, Basic, ammunition authorizations G-15

Table G-17. Sniper Rifle Table IV, Basic authorized range facilities and targetry G-16

Table G-18. Sniper required ballistic instruments G-18

Table G-19. Sniper Rifle, Table IV, firing sequence example G-20

Table G-20. Shot group, grouping, and zeroing standards G-21

Table G-21. Table IV, new firing order, conduct of the range example G-23

Table G-22. Table IV, engagement 0, cold bore shot, conduct of fire example G-24

Table G-23. Table IV, engagement 1, group 1, chronograph and group, conduct of fire example G-25

Table G-24. Table IV, engagement 1, group 2, chronograph and group example G-26

Table G-25. Table IV, engagement 2A, group 1, zeroing, primary optic, conduct of fire example G-27

Table G-26. Table IV, engagement 2A, group 2, zeroing, primary optic, conduct of fire example G-28

Table G-27. Table IV, engagement 2B, group 1, zeroing, iron / backup iron sight, example G-29

Table G-28. Table IV, engagement 2B, group 2, zeroing, iron / backup iron sight, example G-30

Table G-29. Table IV, engagement 2C, group 1, zeroing, thermal, conduct of fire example G-31

Table G-30. Table IV, engagement 2C, group 2, zeroing, thermal, conduct of fire example G-32

Contents

| | |
|--|------|
| Table G-31. Table IV, engagement 2D, group 1, zeroing, attachments, conduct of fire example | G-33 |
| Table G-32. Table IV, engagement 2D, group 2, zeroing, attachments, conduct of fire example | G-34 |
| Table G-33. Table IV, engagement 3A, group 1, confirmation at distance, conduct of fire example | G-35 |
| Table G-34. Table IV, engagement 3A-2, confirmation at distance 2, conduct of fire example | G-36 |
| Table G-35. Table IV, engagement 3B-1, iron / backup iron sight, confirmation at distance 1, conduct of fire example | G-37 |
| Table G-36. Table IV, engagement 3B-2, backup iron sight confirmation at distance 2, conduct of fire example | G-38 |
| Table G-37. Table IV, engagement 3C-1, thermal confirmation at distance 1, conduct of fire example | G-39 |
| Table G-38. Table IV, engagement 3C-2, thermal confirmation at distance 2, conduct of fire example | G-40 |
| Table G-39. Table IV, engagement 3D-1, attachments confirmation at distance 1, conduct of fire example | G-41 |
| Table G-40. Table IV, engagement 3D-2, attachments confirmation at distance 2, conduct of fire example | G-42 |
| Table G-41. Table IV, completed firing order, conduct of the range example | G-43 |
| Table G-42. Sniper Rifle, Table V, Practice | G-44 |
| Table G-43. Training event design template for Sniper Rifle, Table V, Practice | G-45 |
| Table G-44. Sniper Rifle, Table V, Practice, M110 ammunition and scenario requirements | G-46 |
| Table G-45. Sniper Weapon System, Table V, Practice, authorized range facilities | G-46 |
| Table G-46. Authorized modifications to the course of fire | G-51 |
| Table G-47. M110 sniper rifle, Table V, Practice, Stage 1, Day Fire, engagement sequence | G-52 |
| Table G-48. M2010 sniper rifle, Table V, Practice, Stage 1, Day Fire, engagement sequence | G-53 |
| Table G-49. M107 sniper rifle, Table V, Practice, Stage 1, Day Fire, engagement sequence | G-54 |
| Table G-50. Sniper rifle, Table V, Practice, Stage 1, Day Fire throughput time schedule | G-55 |
| Table G-51. Table V, new firing order, conduct of the range example | G-56 |
| Table G-52. Table V, engagement 0, cold bore, conduct of fire example | G-57 |
| Table G-53. Sniper weapons, Table V, Stage 1, Day Fire, engagement 1, conduct of fire example | G-58 |
| Table G-54. Sniper weapons, Table V, Stage 1, Day Fire, engagement 2, conduct of fire example | G-59 |
| Table G-55. Sniper weapons, Table V, Stage 1, Day Fire, engagement 3, conduct of fire example | G-60 |
| Table G-56. Sniper weapons, Table V, Stage 1, Day Fire, engagement 4, conduct of fire example | G-61 |
| Table G-57. Sniper weapons, Table V, Stage 1, Day Fire, engagement 5, conduct of fire example | G-62 |
| Table G-58. Sniper weapons, Table V, Stage 1, Day Fire, engagement 6, conduct of fire example | G-63 |
| Table G-59. Sniper weapons, Table V, Stage 1, Day Fire, engagement 7, conduct of fire example | G-64 |

Table G-60. Sniper weapons, Table V, Stage 1, Day Fire, engagement 8, conduct of fire example G-65

Table G-61. Sniper weapons, Table V, Stage 1, Day Fire, engagement 9, conduct of fire example G-66

Table G-62. Sniper weapons, Table V, Stage 1, Day Fire, engagement 10, conduct of fire example G-67

Table G-63. Table V, completed firing order, conduct of the range example G-68

Table G-64. M110 sniper rifle, Table V, Practice, Stage 2, Night Fire, assisted, engagement sequence G-69

Table G-65. M2010 sniper rifle, Table V, Practice, Stage 2, Night Fire, assisted, engagement sequence G-70

Table G-66. M107 sniper rifle, Table V, Practice, Stage 2, Night Fire, assisted, engagement sequence G-71

Table G-67. Sniper rifle, Table V, Practice, Stage 2, Night Fire, assisted throughput time schedule G-72

Table G-68. Table V, new firing order, conduct of the range example G-73

Table G-69. Table V, engagement 0, cold bore, conduct of fire example G-74

Table G-70. Sniper weapons, Table V, Practice, Stage 2, Night Fire, Assisted, engagement 1, conduct of fire example G-75

Table G-71. Sniper weapons, Table V, Practice, Stage 2, Night Fire, Assisted, engagement 2, conduct of fire example G-76

Table G-72. Sniper weapons, Table V, Practice, Stage 2, Night Fire, Assisted, engagement 3, conduct of fire example G-77

Table G-73. Sniper weapons, Table V, Practice, Stage 2, Night Fire, Assisted, engagement 4, conduct of fire example G-78

Table G-74. Sniper weapons, Table V, Practice, Stage 2, Night Fire, Assisted, engagement 5, conduct of fire example G-79

Table G-75. Sniper weapons, Table V, Practice, Stage 2, Night Fire, Assisted, engagement 6, conduct of fire example G-80

Table G-76. Sniper weapons, Table V, Practice, Stage 2, Night Fire, Assisted, engagement 7, conduct of fire example G-81

Table G-77. Sniper weapons, Table V, Practice, Stage 2, Night Fire, Assisted, engagement 8, conduct of fire example G-82

Table G-78. Sniper weapons, Table V, Practice, Stage 2, Night Fire, Assisted, engagement 9, conduct of fire example G-83

Table G-79. Sniper weapons, Table V, Practice, Stage 2, Night Fire, Assisted, engagement 10, conduct of fire example G-84

Table G-80. Table V, completed firing order, conduct of the range example G-85

Table G-81. Sniper Rifle, Table V, Practice G-86

Table G-82. Training event design template for Sniper Rifle, Table VI, Qualification G-87

Table G-83. Sniper Rifle, Table VI, Qualification, ammunition requirements G-88

Table G-84. Sniper Rifle, Table VI, Qualification, authorized range facilities G-88

Table G-85. Authorized modifications to the course of fire G-93

Table G-86. M110 sniper rifle, Table VI, Qualification, stage 1, day fire, engagement sequence G-94

Contents

| | |
|--|-------|
| Table G-87. M2010 sniper rifle, Table VI, Qualification, stage 1, day fire, engagement sequence | G-95 |
| Table G-88. M107 sniper rifle, Table VI, Qualification, stage 1, day fire, engagement sequence | G-96 |
| Table G-89. Sniper rifle, Table VI, Qualification, stage 1, day fire, throughput time schedule ... | G-97 |
| Table G-90. Table VI, new firing order, conduct of the range example | G-98 |
| Table G-91. Table VI, engagement 0, cold bore, conduct of fire example | G-99 |
| Table G-92. Sniper weapons, Table VI, stage 1, day fire, engagement 1, conduct of fire example | G-100 |
| Table G-93. Sniper weapons, Table VI, stage 1, day fire, engagement 2, conduct of fire example | G-101 |
| Table G-94. Sniper weapons, Table VI, stage 1, day fire, engagement 3, conduct of fire example | G-102 |
| Table G-95. Sniper weapons, Table VI, stage 1, day fire, engagement 4, conduct of fire example | G-103 |
| Table G-96. Sniper weapons, Table VI, stage 1, day fire, engagement 5, conduct of fire example | G-104 |
| Table G-97. Sniper weapons, Table VI, stage 1, day fire, engagement 6, conduct of fire example | G-105 |
| Table G-98. Sniper weapons, Table VI, stage 1, day fire, engagement 7, conduct of fire example | G-106 |
| Table G-99. Sniper weapons, Table VI, stage 1, day fire, engagement 8, conduct of fire example | G-107 |
| Table G-100. Sniper weapons, Table VI, stage 1, day fire, engagement 9, conduct of fire example | G-108 |
| Table G-101. Sniper weapons, Table VI, stage 1, day fire, engagement 10, conduct of fire example | G-109 |
| Table G-102. Table VI, completed firing order, conduct of the range example | G-110 |
| Table G-103. M110 sniper rifle, Table VI, Qualification, Stage 2, Night Fire, Assisted, engagement sequence | G-111 |
| Table G-104. M2010 sniper rifle, Table VI, Qualification, Stage 2, Night Fire, Assisted, engagement sequence | G-112 |
| Table G-105. M107 sniper rifle, Table VI, Qualification, Stage 2, Night Fire, Assisted, engagement sequence | G-113 |
| Table G-106. Sniper rifle, Table VI, Qualification, Stage 2, Night Fire, Assisted, throughput time schedule | G-114 |
| Table G-107. Table VI, new firing order, conduct of the range example | G-115 |
| Table G-108. Table IV, engagement 0, cold bore, conduct of fire example | G-116 |
| Table G-109. Sniper weapons, Table VI, Qualification, Stage 2, Night Fire, Assisted, engagement 1, conduct of fire example | G-117 |
| Table G-110. Sniper weapons, Table VI, Qualification, Stage 2, Night Fire, Assisted, engagement 2, conduct of fire example | G-118 |
| Table G-111. Sniper weapons, Table VI, Qualification, Stage 2, Night Fire, Assisted, engagement 3, conduct of fire example | G-119 |
| Table G-112. Sniper weapons, Table VI, Qualification, Stage 2, Night Fire, Assisted, engagement 4, conduct of fire example | G-120 |

| | |
|---|-------|
| Table G-113. Sniper weapons, Table VI, Qualification, Stage 2, Night Fire, Assisted, engagement 5, conduct of fire example | G-121 |
| Table G-114. Sniper weapons, Table VI, Qualification, Stage 2, Night Fire, Assisted, engagement 6, conduct of fire example | G-122 |
| Table G-115. Sniper weapons, Table VI, Qualification, Stage 2, Night Fire, Assisted, Engagement 7, conduct of fire example | G-123 |
| Table G-116. Sniper weapons, Table VI, Qualification, Stage 2, Night Fire, Assisted, Engagement 8, conduct of fire example | G-124 |
| Table G-117. Sniper weapons, Table VI, Qualification, Stage 2, Night Fire, Assisted, engagement 9, conduct of fire example | G-125 |
| Table G-118. Sniper weapons, Table VI, Qualification, Stage 2, Night Fire, Assisted, engagement 10, conduct of fire example | G-126 |
| Table G-119. Completed firing order, conduct of the range example | G-127 |
| Table H-1. Individual weapons training strategy structure | H-1 |
| Table H-2. Weapons following the urban rifle marksmanship training strategy | H-2 |
| Table H-3. Urban rifle marksmanship training strategy ammunition requirements | H-3 |
| Table H-4. Urban rifle marksmanship, Table I, Preliminary Marksmanship Instruction and Evaluation, task, conditions, and standard | H-4 |
| Table H-5. Training event design template for urban rifle marksmanship, Table I | H-5 |
| Table H-6. Urban rifle marksmanship Table I, Preliminary Marksmanship Instruction and Evaluation training plan | H-6 |
| Table H-7. Urban rifle marksmanship, Table II, Preliminary-Live-Fire Simulations, task, conditions, and standard | H-7 |
| Table H-8. Training event design template for urban rifle marksmanship, Table II, Preliminary-Live-Fire Simulations | H-8 |
| Table H-9. Simulations authorizations table | H-8 |
| Table H-10. Urban rifle marksmanship, Table II, primary and alternate authorized systems | H-9 |
| Table H-11. Urban rifle marksmanship simulations training plan | H-10 |
| Table H-12. Urban rifle marksmanship, Table III, Drills, task, conditions, and standard | H-10 |
| Table H-13. Training event design template for urban rifle marksmanship, Table III, Drills | H-11 |
| Table H-14. Urban rifle marksmanship, Table III, Drills individual training plan | H-12 |
| Table H-15. Urban rifle marksmanship, Table IV, Basic (reflexive fire) | H-13 |
| Table H-16. Training event design template for urban rifle marksmanship, Table IV, Basic (reflexive fire) | H-14 |
| Table H-17. Table IV, Basic (reflexive fire) ammunition authorizations | H-15 |
| Table H-18. Urban rifle marksmanship, Table IV, ammunition breakdown per firer | H-15 |
| Table H-19. Urban rifle marksmanship Table IV, Basic (reflexive fire) authorized range facilities and targetry | H-16 |
| Table H-20. Urban rifle marksmanship, Table IV, firing sequence example | H-18 |
| Table H-21. Table IV, new firing order, conduct of the range example | H-21 |
| Table H-22. Urban rifle marksmanship, Table IV, engagement 1, 10-meter line, conduct of fire example | H-22 |
| Table H-23. Urban rifle marksmanship, Table IV, engagement 2, 10-meter line, conduct of fire example | H-23 |

Contents

| | |
|---|------|
| Table H-24. Urban rifle marksmanship, Table IV, engagement 3, 10-meter line, conduct of fire example | H-24 |
| Table H-25. Urban rifle marksmanship, Table IV, engagement 4, 25-meter line, conduct of fire example | H-25 |
| Table H-26. Urban rifle marksmanship, Table IV, engagement 5, 25-meter line, conduct of fire example | H-26 |
| Table H-27. Urban rifle marksmanship, Table IV, engagement 6, 25-meter line, conduct of fire example | H-27 |
| Table H-28. Urban rifle marksmanship, Table IV, engagement 7 and 8, 25 to 15 meter line, conduct of fire example | H-28 |
| Table H-29. Urban rifle marksmanship, Table IV, engagement 9, 15-meter line, conduct of fire example | H-29 |
| Table H-30. Urban rifle marksmanship, Table IV, engagement 11, 10-meter line, conduct of fire example | H-30 |
| Table H-31. Urban rifle marksmanship, Table IV, engagement 12, 10-meter line, conduct of fire example | H-31 |
| Table H-32. Urban rifle marksmanship, Table IV, engagement 13 and 14, 25-meter to 5-meter line, conduct of fire example | H-32 |
| Table H-33. Urban rifle marksmanship, Table IV, engagement 15 and 16, 15-meter line, conduct of fire example | H-33 |
| Table H-34. Table IV, completed firing order, conduct of the range example | H-34 |
| Table H-35. Urban rifle marksmanship, Table V, Practice | H-35 |
| Table H-36. Training event design template for urban rifle marksmanship, Table V, Practice .. | H-36 |
| Table H-37. Urban rifle marksmanship, Table V, Practice, ammunition authorizations | H-37 |
| Table H-38. Urban rifle marksmanship, Table V, Practice authorized range facilities and targetry | H-37 |
| Table H-39. Urban rifle marksmanship Table V, Practice authorized range facilities and targetry | H-38 |
| Table H-40. Urban rifle marksmanship, Table V, firing sequence example | H-41 |
| Table H-41. Table V, new firing order, conduct of the range example | H-43 |
| Table H-42. Table V, engagement 1, 5-meter line, conduct of fire example | H-44 |
| Table H-43. Table V, engagement 2, 10-meter line, conduct of fire example | H-45 |
| Table H-44. Table V, engagement 3, 10-meter line, conduct of fire example | H-46 |
| Table H-45. Table V, engagement 4, 10-meter line, conduct of fire example | H-47 |
| Table H-46. Table V, engagement 5, 10-meter line, conduct of fire example | H-48 |
| Table H-47. Table V, engagement 6, 25-meter line, conduct of fire example | H-49 |
| Table H-48. Table V, engagement 7, 25-meter line, conduct of fire example | H-50 |
| Table H-49. Table V, engagement 8, 20-meter line, conduct of fire example | H-51 |
| Table H-50. Table V, engagement 9, 15-meter line, conduct of fire example | H-52 |
| Table H-51. Table V, engagement 10, 15-meter line, conduct of fire example | H-53 |
| Table H-52. Table V, completed firing order, conduct of the range example | H-54 |
| Table H-53. Urban rifle marksmanship, Table VI, Certification | H-55 |
| Table H-54. Training event design template for urban rifle marksmanship, Table VI, Certification | H-56 |
| Table H-55. Urban rifle marksmanship, Table VI, Certification, ammunition authorizations | H-57 |

Table H-56. Urban rifle marksmanship, Table VI, ammunition breakdown per firer H-58

Table H-57. Urban rifle marksmanship, Table VI, Certification, authorized range facilities and targetry H-58

Table H-58. Urban rifle marksmanship, Table VI, firing sequence example H-61

Table H-59. Table VI, new firing order, conduct of the range example H-63

Table H-60. Table VI, engagement 1, 5-meter line, conduct of fire example H-64

Table H-61. Table VI, Engagement 2, 10-meter line, conduct of fire example H-65

Table H-62. Table VI, engagement 3, 10-meter line, conduct of fire example H-66

Table H-63. Table VI, engagement 4, 10-meter line, conduct of fire example H-67

Table H-64. Table VI, engagement 5, 10-meter line, conduct of fire example H-68

Table H-65. Table VI, engagement 6, 25-meter line, conduct of fire example H-69

Table H-66. Table VI, engagement 7, 25-meter line, conduct of fire example H-70

Table H-67. Table VI, engagement 8, 20-meter line, conduct of fire example H-71

Table H-68. Table VI, engagement 9, 15-meter line, conduct of fire example H-72

Table H-69. Table VI, engagement 10, 15-meter line, conduct of fire example H-73

Table H-70. Table VI, Completed firing order, conduct of the range example H-74

Table I-1. Individual weapons training strategy structure I-1

Table I-2. Assisted night fire training strategy ammunition requirements I-2

Table I-3. Assisted night fire, Table I, Preliminary Marksmanship Instruction and Evaluation I-3

Table I-4. Training event design template for assisted night fire, Table I I-4

Table I-5. Assisted night fire, Table I, Preliminary Marksmanship Instruction and Evaluation training plan for M4 / M16 firers I-5

Table I-6. Assisted night fire, Table I, Preliminary Marksmanship Instruction and Evaluation training plan for M24AR firers I-6

Table I-7. Assisted night fire, Table II, Preliminary Live-Fire Simulations..... I-7

Table I-8. Training event design template for assisted night fire, Table II, Preliminary-Live-Fire Simulations I-8

Table I-9. Simulations authorizations table I-9

Table I-10. Assisted night fire, Table II, primary and alternate authorized systems I-9

Table I-11. Assisted night fire simulations training plan I-10

Table I-12. Assisted night fire, Table III, Drills, task, conditions, and standard I-11

Table I-13. Training event design template for assisted night fire, Table III, Drills I-12

Table I-14. Assisted night fire, Table III, Drills individual training plan I-13

Table I-15. Assisted night fire, Table IV, Basic I-14

Table I-16. Training event design template for assisted night fire, Table IV, Basic I-15

Table I-17. Table IV, Basic, ammunition authorizations I-16

Table I-18. Assisted night fire, Table IV, ammunition breakdown per firer I-17

Table I-19. Assisted night fire Table IV, Basic authorized range facilities and targetry I-18

Table I-20. Assisted night fire, Table IV, firing sequence example I-21

Table I-21. Table IV, new firing order, conduct of the range example I-21

Table I-22. Table IV, engagement 1, first shot group, conduct of fire example I-22

Table I-23. Table IV, engagement 1, first shot group, conduct of fire example I-23

Contents

| | |
|---|------|
| Table I-24. Table IV, engagement 2, second shot group, conduct of fire example | I-24 |
| Table I-25. Table IV, engagement 3, third shot group, conduct of fire example | I-25 |
| Table I-26. Table IV, engagement 4, group one, conduct of fire example | I-26 |
| Table I-27. Table IV, engagement 5, zeroing group two, conduct of fire example | I-27 |
| Table I-28. Table IV, engagement 6, zeroing group three, conduct of fire example | I-28 |
| Table I-29. Table IV, engagement 7, confirmation at distance, conduct of fire example | I-30 |
| Table I-30. Table IV, engagement 8, application of hold-offs, conduct of fire example | I-31 |
| Table I-31. Table IV, completed firing order, conduct of the range example | I-32 |
| Table I-32. Assisted night fire, Table V, Practice | I-33 |
| Table I-33. Training event design template for assisted night fire, Table V, Practice | I-34 |
| Table I-34. Assisted night fire, Table V, Practice ammunition requirements | I-35 |
| Table I-35. Assisted night fire, Table V, Practice ammunition breakdown | I-36 |
| Table I-36. Assisted night fire, Table V, Practice authorized range facilities | I-37 |
| Table I-37. Assisted night fire Table V, Practice, engagement sequence | I-39 |
| Table I-38. Assisted night fire, Table V, Practice, throughput time schedule | I-44 |
| Table I-39. Table V, new firing order, conduct of the range example | I-45 |
| Table I-40. Table IV, engagement 7, confirmation at distance, conduct of fire example | I-46 |
| Table I-41. Table IV, engagement 8, application of hold-offs, conduct of fire example | I-47 |
| Table I-42. Table V, engagement 1 through 5, conduct of fire example | I-48 |
| Table I-43. Table V, engagement 6 through 10, conduct of fire example | I-49 |
| Table I-44. Table V, engagement 11 through 14, conduct of fire example | I-50 |
| Table I-45. Table V, engagement 15 through 18, conduct of fire example | I-51 |
| Table I-46. Table V, stage 2, conduct of fire example | I-52 |
| Table I-47. Table V, engagement 19 through 22, conduct of fire example | I-53 |
| Table I-48. Table V, completed firing order, conduct of the range example | I-54 |
| Table I-49. Assisted night fire, Table VI, Certification task, conditions, and standard | I-55 |
| Table I-50. Training event design template for assisted night fire, Table VI, Certification | I-56 |
| Table I-51. Stage descriptions, assisted night fire, Table VI, Certification | I-56 |
| Table I-52. Assisted night fire, Table VI, Certification ammunition requirements | I-57 |
| Table I-53. Assisted night fire, Table VI, Certification ammunition breakdown | I-58 |
| Table I-54. Assisted night fire, Table VI, Certification authorized range facilities | I-59 |
| Table I-55. Assisted night fire Table VI, Certification, stage 1, engagement sequence | I-61 |
| Table I-56. Assisted night fire, Table VI, Certification throughput time schedule | I-66 |
| Table I-57. Table VI, new firing order, conduct of the range example | I-67 |
| Table I-58. Table IV, engagement 7, confirmation at distance, conduct of fire example | I-68 |
| Table I-59. Table IV, engagement 8, application of hold-offs, conduct of fire example | I-69 |
| Table I-60. Table VI, engagement 1 through 5, conduct of fire example | I-70 |
| Table I-61. Table VI, engagement 6 through 10, conduct of fire example | I-71 |
| Table I-62. Table VI, engagement 11 through 14, conduct of fire example | I-72 |
| Table I-63. Table VI, engagement 15 through 18, conduct of fire example | I-73 |
| Table I-64. Table VI, stage 2, conduct of fire example | I-74 |

Table I-65. Table VI, engagement 19 through 22, conduct of fire example I-75
Table I-66. Table VI, completed firing order, conduct of the range example I-76

This page intentionally left blank.

Preface

TC 3-20.40 provides the outline for all individual weapon's training strategies, resources, prerequisites, and requirements for planning and executing training. It provides a single reference for commanders, staff, planners, and trainers.

The principal audience for TC 3-20.40 is all members of the profession of arms. Commanders and staffs of Army headquarters serving as joint task force or multinational headquarters should also refer to applicable joint or multinational doctrine concerning the range of military operations and joint or multinational forces. Trainers and educators throughout the Army will also use this publication.

Commanders, staffs, and subordinates ensure that their decisions and actions comply with applicable United States, international and, in some cases, host-nation laws and regulations. Commanders at all levels ensure that their Soldiers operate in accordance with the Law of Warfare, the Army Ethic, and the rules of engagement. (See FM 27-10.)

TC 3-20.40 uses joint terms where applicable. Selected joint and Army terms and definitions appear in both the glossary and the text. Terms for which TC 3-20.40 is the proponent publication (the authority) are italicized in the text and are marked with an asterisk (*) in the glossary. Terms and definitions for which this publication is the proponent are boldfaced in the text. For other definitions shown in the text, the term is italicized and the number of the proponent publication follows the definition.

TC 3-20.40 applies to the Active Army, the Army National Guard, the Army Civilian Corps, and the United States Army Reserve unless otherwise stated. Users and readers of this publication are invited to submit recommendations that will improve its effectiveness.

The proponent of this publication is the United States Army Training and Doctrine Command. The preparing agency is the Doctrine and Collective Training Division, Maneuver Center of Excellence. Send comments and recommendations on a DA Form 2028 (*Recommended Changes to Publications and Blank Forms*) to the point of contact. Comments may be sent by any means, U.S. mail, or electronic as long as you use or follow the format of DA Form 2028. Point of contact information is as follows.

E-mail: usarmy.benning.mcoe.mbx.doctrine@mail.mil

U.S. Mail: Commander, Maneuver Center of Excellence
Directorate of Training and Doctrine
Doctrine and Collective Training Division
ATTN: ATZB-TDD
Fort Benning, GA 31905-5410

This page intentionally left blank.

Introduction

TC 3-20.40 describes how a unit builds their unit training plan (UTP) for individual weapons. It provides all the information needed to plan, prepare, execute, and assess individual weapons training strategies and certifications. The training strategies described follow the progressive and gated structure of the integrated weapons training strategy. This manual defines the Army-standard requirements for individual weapons qualification and establishes those qualifications as prerequisites for continued training for either specific capability certification or collective live-fire training.

TC 3-20.40 composed of four chapters and nine appendixes, and is specifically tailored to the training strategy, qualification standards, and various weapons certifications of current individually assigned weapons in the Army's inventory. TC 3-20.40 is organized in a progressive manner so that each chapter provides the information a unit requires to plan and prepare for weapons training. The appendixes include the "how to" execute the training event according to each weapons training strategy or certification. The appendixes also include essential information concerning ammunition, forms, and weapons safety.

TC 3-20.40 applies to all Soldiers, regardless of experience or position, who are assigned an individual weapon. This publication is designed specifically for unit commanders, training managers, and staff to tailor small arms training to achieve the appropriate level of lethality and proficiency.

CHAPTERS

The chapters provide commanders, staff, and planners with key information about the individual weapons training strategy, how to plan and prepare for each training strategy event, and the resources (facilities, equipment, training aids, devices, simulators, and simulations [known as TADSS], and ammunition) required to train the events to standard.

CHAPTER 1 – INDIVIDUAL WEAPONS TRAINING

- This chapter provides an overview of the strategy principles used to develop the integrated weapons training strategy in this manual. It describes the training strategy structure used, how that structure is integrated into other weapons, systems, platforms, and maneuver echelon training strategies. It describes the table structure, the purpose for each type of event, and the weapons specifically categorized as individual, crew-served, or special purpose weapons.
- In general terms, this chapter describes the basic planning and preparation of training events to maximize the unit's training time. It provides examples of how a unit may execute the prerequisite to live-fire events and the most efficient and effective manner for those live-fire events.
- The chapter culminates with the individual weapons qualification standards and validation procedures. This section provides the minimum live-fire standards to qualify on an individual weapon, provides the rules used to determine when a qualification is no longer valid, and provides the guidelines for using a method of validating existing qualifications for pistols, rifles, and carbines.

CHAPTER 2 – UNIT TRAINING PLANS

- This chapter provides information about the unit’s development of individual weapons training plans. It includes information about the roles and responsibilities of marksmanship master trainers (known as MMT) in the organization, and the skills and function they provide to the organization.
- The chapter includes an outline for developing UTPs. The chapter begins with the commander’s assessment of current proficiency, an evaluation of key-leader turbulence, mission essential tasks, and warfighting skills. The chapter incorporates the command training guidance into the development process and provides a timeline of key tasks and actions leading up to the weapon’s training that serve as a planning and preparation guide.

CHAPTER 3 – RANGE REQUIREMENTS

- This chapter discusses the various Army systems, range facilities, instrumentation, and targetry that support the unit’s weapons training. It highlights individual range requirements that enable realistic, challenging training when using the individual weapons training strategies. It details all additional requirements associated with individual weapons training, qualification, and advanced skill or capability certification.
- It provides a reference to the Army’s family of small arms and crew-served range facilities that support the unit’s weapons training. It identifies which facilities best support each training strategy event, and defines the targetry used in this manual’s training events. It specifies specialty equipment or instrumentation for improving lethality for Soldiers who are training for tactical employment of their individual weapons.
- It includes a guideline on how to effectively proof the range facility to ensure the Army-standard target presentations are provided to the training unit. It establishes the minimum requirements for proper target presentations and describes the process to verify those requirements.

CHAPTER 4 – RANGE OPERATIONS

- This chapter provides information for operating a range facility that supports individual weapons in an effective and efficient manner. It provides the procedures, duties, and responsibilities for planning, preparing, and executing small arms live-fire ranges for individual weapons.
- The chapter is designed to enhance the knowledge of the personnel tasked to operate a range for the training unit. The chapter provides a guide for each member of the range support personnel team tasked to run a live-fire event.
- The chapter includes common items used on the ranges, where they are obtained or the organization that provides them, and assigns duties and responsibilities for all support personnel. The chapter is designed to assist the unit in conducting live-fire ranges efficiently to achieve the best training for their Soldiers while maximizing the facility to its throughput potential.

APPENDIXES

The appendixes provide general information on ammunition, how to complete the respective Department of the Army forms used during training, as well as each integrated weapons training strategy guideline for execution. They include some common certifications for use at the unit level—as prerequisites for higher risk collective training events, advanced skills, or capabilities. These appendixes are designed to provide the trainer, noncommissioned officer, or range personnel the information on how to successfully conduct each training strategy event. They outline preliminary live-fire requirements, alignment and calibration procedures, and live-fire requirements for each respective individual weapon.

The training strategies found in the weapon’s appendixes provide the standard format of six tables (events). Each table’s events are explained with all associated resources required: ranges, simulators, simulations, ammunition, and time, as appropriate. The

weapons appendix is divided into sections, one for each training event (table) for each weapons training strategy. Following the military decisionmaking process, each section describes the necessary information to plan, prepare, execute, and assess each training event. Companies executing the training events apply the eight-step training model, as appropriate.

APPENDIX A – AMMUNITION

This appendix provides general information on individual weapon ammunition for training and combat use. It provides the trainer with an overview of key ammunition topics for familiarization prior to use, ordering, receiving, and accountability.

APPENDIX B – FORMS

This appendix describes to trainers and units to describe how to properly fill out the associated forms and scorecards for each live-fire event. The forms are listed in numerical order for rapid access and reference. For the official forms, units should go to the Army Published Directorate website. These forms represent the official training record for the live-fire event they support.

APPENDIX C – WEAPONS SAFETY

This appendix reiterates key weapons safety topics; the rules of firearms safety, weapons safety status, and weapons control status. These weapons safety topics are integrated throughout all weapons training strategies, regardless of the training event. These weapons safety topics provide a common level of understanding which build the Soldier's ownership of each fired shot and personal responsibility for the effects of those rounds.

APPENDIX D – PISTOL

The pistol appendix provides information about the entire pistol training strategy through qualification. It provides the detailed resource requirements for each event, the sequence of events for live-fire scenarios, and an example of the administrative tower prompt to smoothly conduct the event. It provides information on simulation requirements that coincide with qualification, and identifies the task, conditions, and standards for each training event.

APPENDIX E – RIFLE AND CARBINE

The rifle and carbine appendix provides information about the entire training strategy through qualification. It provides detailed resource requirements for each event, the sequence of events for live-fire scenarios, and an example of the administrative tower prompt to efficiently conduct the event. It provides information on simulations requirements that coincide with qualification and identifies the task, conditions, and standards for each training event.

APPENDIX F – AUTOMATIC RIFLE

The automatic rifle appendix provides information about the entire training strategy through qualification. This training strategy is specific to the M249 used in the automatic rifleman role only. It provides detailed resource requirements for each event, the sequence of events for live-fire scenarios, and an example of the administrative tower prompts to conduct the live-fire event. It provides the task, conditions, and standards for each training event.

APPENDIX G – SNIPER

This appendix covers the series of sniper weapon systems (M110, M2010, and M107). It specifically describes the strategy for each training event through qualification. It provides the task, conditions, and standards for each event, and identifies all training resources required to complete the training events to standard. It provides information on acceptable modifications when primary range facilities, structures, instrumentation, or targetry are not available on an installation to train to proficiency.

APPENDIX H – URBAN RIFLE MARKSMANSHIP

This appendix describes the training strategy for the urban rifle marksmanship certification. The certification provides a known prerequisite for Soldiers assigned the rifle, carbine, or automatic rifle to successfully complete prior to any collective live fire using a shoot house or similar facility. It provides the commander the ability to assess their Soldier's proficiency tactically employing their weapon in close quarters.

APPENDIX I – ASSISTED NIGHT FIRE

The training described in this appendix is for Soldiers who are assigned the rifle, carbine, or automatic rifle with thermal optics or pointers, illuminators, or lasers. The successful completion of this certification is required prior to any collective night live-fire event where these optics or equipment are tactically employed by the Soldier.

Chapter 1

Individual Weapons Training

This chapter describes how a unit builds their unit training plan (UTP) for individual weapons. It follows the progressive and gated structure of the integrated weapons training strategy (known as IWTS) to describe a general overview of the training events found in each respective weapons training strategy.

Although this chapter is specific to individual weapons, it is important for units to understand how the training structure relates to individual, crew-served, and special purpose weapons. This chapter provides a brief definition and description of these three weapons categories. The individual, crew-served, and special purpose training strategies maximizes the use of training aids, devices, simulators, and simulations in a systematic and progressive manner to increase and sustain Soldier and unit proficiency, effectiveness, and lethality. The training strategies are capability-based (weapon / system, ammunition, optics, Soldier) and maximizes the training resources available.

These strategies are directly synchronized with echelon-based proficiency gates established in the sustainable readiness model (known as SRM). The strategies meet the established training proficiency gates and standards for weapons proficiency.

This chapter provides Soldiers with the basic information to understand the mechanics of individual, crew-served, and special purpose weapons training strategy events. Units reference the appropriate appendix for individual weapons or the respective training circular for crew-served and special purpose weapons to develop a comprehensive UTP.

The latter portion of this chapter specifically focuses on the IWTS and describes how the strategy is designed for efficient execution and culminates with the qualification, validation, and certification standards. It describes the strategy structure that enables units to train and qualify Soldiers on their assigned weapons and certify them on all assigned devices and equipment.

STRATEGY PRINCIPLES

1-1. The IWTS is a single, overarching strategy based on the training requirements of each weapon, system, or unit echelon to achieve combat readiness across the various maneuver formation types. It includes individual, crew-served, and direct-fire crew platforms, and indirect (mortar) fires, as well as small unit formations (squads, sections, and platoons), and companies, and battalions. The IWTS includes the training and proficiency requirements for the battalion's staff and their ability to coordinate fires in their operational environment.

1-2. These separate training strategies work in a collaborative manner to support all collective live environment training events that culminate in combined arms live-fire exercises for maneuver company-level units, and the fire coordination exercise at battalion-level. These strategies follow nine specific principles to provide commanders with flexible, tailorable, and effective training events that build the desired level of proficiency. The nine strategy principles of the IWTS are described below.

FUNDAMENTALS FIRST

1-3. Fundamental Soldier and military occupational specialty specific skills serve as the foundation of the IWTS and must not be overlooked. Soldiers, crews, teams, squads, platoons, companies, and battalions achieve the highest level of proficiency when building upon mastery of those foundational skills. The strategies built using the IWTS structure update existing qualification or certification events to ensure critical fundamental tasks expected of all Soldiers, crews, teams, and small units are trained and tested first. This includes identifying training gaps, developing solutions, and applying the solutions within the guidelines of the strategy review.

MAXIMIZE VIRTUAL SYSTEMS

1-4. Augment the live environment training strategy with an effective and efficient use of available virtual systems to train and prepare Soldiers, leaders, and units for the subsequent progressive live-fire training events. Not all weapons, platforms, or small units have simulations or virtual systems available. Each subordinate training strategy will detail the required or authorized simulation system, as appropriate.

Note. Simulations are not authorized as a qualification means except certain antitank guided missiles (tube-launched, optically tracked, wire-guided missile, antitank guided missile and the Javelin missile system, for example). This is the exception and not the norm. Units should strive to accomplish live-fire events with these systems, when possible.

SYNCHRONIZED COMPONENTS

1-5. Each strategy must complement and integrate progressively with higher echelon training strategies. For instance, the sniper team training strategy must seamlessly integrate into squad, platoon, and company training strategies where a training requirement in the sniper team strategy is supported in the collective small unit strategy. Synchronized components allows for effective integration in collective training events to maximize command flexibility. This facilitates a “plug-and-play” capability for the squad and collective training events. The strategy includes integration of other warfighting functions during the collective training events.

ADAPTABLE TO CHANGE

1-6. The strategy must easily adapt to current and future Army guidance. The strategy must be able to adjust to any future changes or alterations to the SRM, as defined in Army Regulation (AR) 525-29, and meet the proficiency reporting requirements detailed in AR 220-1.

ESTABLISH PROGRESSIVE AND GATED EVENTS

1-7. Gated events are the culminating external evaluations of each strategy that provide an assessment of overall proficiency at echelon using a standardized method. The culminating event (or events) establishes the prerequisites that must be completed prior to progressing to the live-fire events at the next higher echelon.

CULMINATE IN COMBINED ARMS COLLECTIVE TRAINING EVENTS

1-8. Each separate training strategy builds to a culminating collective combined arms live-fire event. This facilitates the “train as you fight” concept across all echelons and formations and provides the commander with the capability to seamlessly integrate combined arms assets and external warfighter functions into collective, combined arms training events.

Note. Although this publication does not contain any collective live-fire events, the qualifications and certifications described are prerequisites to those events.

FACILITATE RAPID DEPLOYMENT CAPABILITIES

1-9. The strategy provides a high level of proficiency early in the maneuver training cycle enabling small unit through brigade combat team (BCT) decisive action capabilities. This implies successful completion of “combat ready” minimum proficiency for an entire BCT within a six-month or less training period.

PROVIDE COMMANDER FLEXIBILITY

1-10. Commanders must have the flexibility during collective training to support their directed mission, expected operational environment, and desired force structure. This flexibility does not include whether the event needs to be conducted, but rather facilitates the level of complexity, combined arms integration requirements and options, and identifies various methods to increase the training realism for the commander. The flexibility focuses on how the training replicates the unit’s combat role effectively through scenario development, integration of warfighter functions, and tailored formations during the collective events. This enables the commander to define the force structure required to meet the operational needs and trains that custom formation with existing resource authorizations.

Note. The IWTS and all integrated supporting training strategies are designed for home station training. Initial entry training and training requirements while deployed in austere environments are not described in this manual.

REINFORCE THE RULES OF ENGAGEMENT AND ETHICAL DECISION MAKING

1-11. The weapons training events include reinforcement of the rules of engagement (ROE) and ethical decision making concerning the application of lethal force (for example, that all members of the Army profession are expected to live by, adhere to, and uphold the moral principles of the Army ethic). Realistic training includes moral and ethical decision-making and includes ethical challenges and dilemmas to build critical thinking while employing weapons, systems, or formations during tactical operations.

1-12. The training strategy includes active and passive decision points for building our trusted Army professionals who accomplish their missions in the right way—ethically, effectively, and efficiently. The strategy’s training events, particularly during the collective training event, build a shared understanding and mutual trust of the leaders and Soldiers necessary to develop cohesive teams of trusted Army professionals.

STRATEGY STRUCTURE

1-13. The IWTS is integrated with the SRM, and as such, is not tied to the fiscal year. The IWTS is composed of the critical training events that build toward a known level of training, culminating with qualification for each weapon, system, and echelon through the BCT. Other training publications will identify the frequency of training based on the unit’s component or mission. For example, DA PAM 350-38 will identify the frequency of the specific event authorized during a fiscal year for both active and reserve components.

1-14. Units must understand the elements, components, and structure of the IWTS to build the overall comprehensive training strategy. These elements create the basic functionality of the IWTS and are described in general terms in this section.

1-15. Table 1-1, on page 1-4, shows the IWTS structure for all weapons, systems, crews, and collective unit training strategy through the BCT. While the echelon-based structure provides a sequential list of events, the commander has the flexibility to alter the training sequence, provided the unit completes the described prerequisites. The IWTS events listed in this publication are not all encompassing. They are the essential home station training events that create the critical path requirement to achieve unit readiness at echelon. Units may include additional training events in their UTP but must use existing resources or secure additional resources from the evaluation commander.

Table 1-1. Integrated weapons training strategy structure

| Echelon | Table I, PREREQ | Table II, PREREQ | Table III, PREREQ | Table IV, Collective Task Proficiency | Table V, COORD / Rehearsal / Practice | Table VI, Live-Fire Proficiency Gate |
|----------------------------|-----------------------------|---------------------------|------------------------|--|--|---|
| | CRAWL | CRAWL | WALK | RUN | RUN | RUN |
| Battalion | TEWT <i>Live</i> | STAFFEX <i>Blended</i> | CPX <i>Live</i> | FTX <i>TADSS</i> | FCX <i>Blended</i> | CALFEX <i>Live-Fire</i> |
| Company | TEWT <i>Live</i> | STX-V <i>Virtual</i> | STX <i>TADSS</i> | FTX <i>TADSS</i> | FCX <i>Live-Fire</i> | CALFEX <i>Live-Fire</i> |
| Platoon | CLASS SOP <i>Live</i> | STX-V <i>Virtual</i> | STX <i>TADSS</i> | FTX <i>TADSS</i> | FCX <i>Live-Fire</i> | LFX <i>Live-Fire</i> |
| Section | | | | | | |
| Squad | | | | | | |
| Mortar Formation | GST <i>Live</i> | STX-V <i>Virtual</i> | STX <i>TADSS</i> | FTX <i>TADSS</i> | Practice <i>Live-Fire</i> | Qualification <i>Live-Fire</i> |
| Crew Platform | | | | Basic <i>Live-Fire</i> | | |
| Special Purpose Weapons | PMI&E <i>Live</i> | PLFS <i>Virtual</i> | Drills <i>TADSS</i> | Basic <i>Live-Fire</i> | Practice <i>Live-Fire</i> | Qualification <i>Live-Fire</i> |
| Crew-Served Weapons | | | | | | |
| Individual Weapons | | | | | | |

Legend: CALFEX – combined arms live-fire exercise, COORD – coordination, CPX – command post exercise, FCX – fire coordination exercise, FTX – field training exercise, GST – gunnery skills test, LFX – live-fire training exercise, PLFS – preliminary live-fire simulations, PMI&E – preliminary marksmanship instruction and evaluation, PREREQ – prerequisite, SOP – standard operating procedure, STAFFEX – staff exercise, STX – situational training exercise, TADSS – training aids, devices, simulators, and simulations, TEWT – tactical exercise without troops, V – virtual training environment

Note. Events listed as “blended” enable commanders to use either the blended training environment or integrated training environment to best achieve the training objectives (FM 7-0).

TABLES

1-16. Each weapon or munition’s training strategy has up to six training events that culminate in the Soldier’s demonstration of proficiency during Table VI, Qualification. The training events occur along the critical path to proficiency for individual weapon.

1-17. The training structures for these weapons (see table 1-2) are described in the following sections. In some cases, a weapon may not include all tables for training through qualification. The respective weapon’s training publication specifically states those exceptions. Any additional training events for certifications or validation are not shown.

Table 1-2. Standard individual, crew-served, and special purpose weapons training table structure

| | <i>Table I,</i> | <i>Table II,</i> | <i>Table III,</i> | <i>Table IV,</i> | <i>Table V,</i> | <i>Table VI,</i> |
|--|------------------|--------------------|-------------------|-------------------|-----------------|--|
| Function | PREREQ | PREREQ | PREREQ | Group Zero | Practice | Live-Fire Proficiency Gate (LFPG) |
| Training Principle | CRAWL | CRAWL | WALK | WALK | RUN | RUN |
| Environment | Live | Virtual | Live | Live | Live | Live |
| Condition | Hands-On | TADSS (Simulation) | TADSS | Live Fire | Live Fire | Live Fire |
| Title | PMI&E | PLFS | Drills | Basic | Practice | QUAL |
| Days Required | 0.5 | 0.5 | 1.0 | 0.5 | 1.0 | 1.0 |
| Legend: PLFS – preliminary live-fire simulation, PMI&E – preliminary marksmanship instruction and evaluation, PREREQ – prerequisite to live fire, QUAL – qualification, TADSS – training aids, devices, simulators, and simulations | | | | | | |

ECHELON-BASED CATEGORIES

1-18. The complete IWTS is grouped in echelon-based categories, with the inclusion of individual, crew-served, and special purpose weapons. These categories contain the complete training cycle for the weapon, system, or echelon. The categories are completed in ascending order: from individual, crew-served, and special purpose weapons, mortar formations, crew platforms, and squad through battalion echelons.

1-19. This section describes the weapons categories, defines where they are used, and other relevant information. Units must have a working knowledge of the standardized weapons categories to best implement the training structure of the IWTS at home station. Units use the weapons categories to create a training plan that supports their training and qualification requirements. Table 1-3, on page 1-6, shows the weapons categories used in the IWTS.

Table 1-3. Integrated weapons training strategy weapons categories

| Category | Type | Abbreviation |
|--|------------------------------|---------------------|
| Individual, crew-served, and special purpose weapons | Individual weapons | INDWPN |
| | Crew-served weapons | CSW |
| | Special-purpose weapons | SPW |
| Mortar formation and crew platforms | Mortar sections and platoons | MTR |
| | Crew platforms | CREW-P |
| Maneuver echelon | Squads | SQD |
| | Section | SEC |
| | Platoon | PLT |
| | Company | CO |
| | Troop | TRP |
| | Battalion | BN |
| | Squadron | SQDN |

Note. It is important for units to understand the context of the IWTS to effectively build UTPs. This publication only provides the details for training through qualification of individual weapons. Units should reference other weapons category or echelon training publications for information about developing those respective training plans.

1-20. Descriptions of the individual, crew-served, and special purpose weapons are provided in the following sections. They are provided to help the unit to visualize the weapons and the standard training structures. Understanding the definitions of those weapons categories, and understanding which weapons belong in each category is critical for training, qualifying, certifying, and reporting those outcomes correctly.

INDIVIDUAL WEAPONS

1-21. Each individual weapon belongs in a table of organization and equipment (TO&E) / modified table of organization and equipment (MTOE) / or table of distribution and allowances and is specifically assigned to and operated by a single Soldier (see table 1-4). When more than one individual weapon is assigned to a Soldier, one is designated as the primary weapon and the others are designated as secondary weapons. Soldiers train through qualification on all individual weapons assigned, regardless of whether the weapons are designated as primary or secondary:

- Primary weapon. The individual weapon assigned to a Soldier whose principal function is personal protection, which provides the major direct fire capability during lethal engagements. A Soldier only has one primary weapon.
- Secondary weapon. An individual or special purpose weapon assigned or designated to a Soldier whose principal function is increased capability, function, or purpose beyond or instead of the primary weapon. A Soldier may have multiple secondary weapons.

Table 1-4. Individual weapons

| <i>Weapon</i> | <i>Weapon Type</i> | <i>LIN</i> | <i>Weapon Publication</i> |
|--|----------------------------|------------------|---------------------------|
| M9 | Pistol | P98152 | TC 3-23.35 |
| M17 | Pistol | Z05425 | TC 3-23.35 |
| M18 | Pistol | Z05424 | TC 3-23.35 |
| M4 M4A1 | Carbine | R97234 C06935 | TC 3-22.9 |
| M16A2 M16A4 | Rifle | R95035 R97175 | TC 3-22.9 |
| M249AR | Automatic rifle | M09009 | TC 3-22.249 |
| M110 | Light sniper weapon system | R45601 | TC 3-22.10 |
| M2010 | Light sniper weapon system | R05009 | TC 3-22.10 |
| M107 | Heavy sniper weapon system | R45351 | TC 3-22.10 |
| <p>Note: The military police are the proponent of the M11, pistol (LIN P47365) and it is not discussed in this manual.</p> <p>Units should pay particular attention to the M249AR as an individual weapon. The M249L variant is specifically classified as a crew-served weapon.</p> <p>Legend: M249AR – automatic rifle, LIN – line item number, TC – training circular</p> | | | |

1-22. Soldiers may be assigned multiple weapons, not necessarily from the same category (individual, crew-served, or special purpose). Soldiers assigned multiple individual weapons will identify one as the primary weapon and the other as a secondary weapon. Those assignments and designations direct the training strategies the Soldier conducts as part of their overall individual proficiency.

Note. For example, a Soldier is assigned two individual weapons: an M4 and an M17. The M4 is the primary weapon and the M17 is the secondary weapon. The Soldier must qualify on both according to the Army standard and directed frequency of qualification.

INDIVIDUAL WEAPONS TABLES

1-23. The six individual weapons tables are—

- Table I – Preliminary Marksmanship Instruction and Evaluations.
- Table II – Pre-Live-Fire Simulations.
- Table III – Drills.
- Table IV – Basic.
- Table V – Practice.
- Table VI – Qualification (Live-Fire Proficiency Gate).

1-24. Some tables include subcomponents that serve as a control mechanism during the event or provide training requirements for additional capabilities. There are two primary subcomponents to individual weapons tables—

- Stages – define specific capabilities that require specific training. Stages may require multiple phases (see below) to accomplish the desired training outcomes or proficiency. Not all training events require the use of stages. They are a means of describing the conditions of the firing environment, typically by visibility, chemical environment, and optical assistance. The common stages for individual weapons are—
 - Day fire.
 - Day fire, chemical, biological, radiological and nuclear (CBRN).

- Night fire.
- Night fire, CBRN.
- Phases – define changes to the training event where specific firing postures and level of stability are assumed by the firer. Not all tables include separate phases. The common phases to a table are based on the required firing positions:
 - Prone unsupported.
 - Prone supported.
 - Kneeling supported.
 - Standing supported.

1-25. Table 1-5 shows an example of the general table structure with stages and phases for rifle and carbines. It provides an example of how stages and phases are used in the training strategy.

Table 1-5. Rifle and carbine, qualification and certification use of stages and phases, example

| <i>Stage</i> | <i>Phase</i> | | | |
|---|--------------------------|------------------------|---------------------------|---------------------------|
| | <i>Prone Unsupported</i> | <i>Prone Supported</i> | <i>Kneeling Supported</i> | <i>Standing Supported</i> |
| Day Fire | X | X | X | X |
| Day Fire, Chemical, biological, radiological, and nuclear (CBRN) | | | | X |
| Night Fire | | | X | |
| Night Fire, CBRN | | | X | |

CREW-SERVED WEAPONS

1-26. A man-portable weapon or system assigned to a team (gunner, assistant gunner, and appropriate number of ammunition bearers in support) trained and qualified in the ground (dismounted) role. The team typically consists of two or more personnel:

- Gunner – the primary firer.
- Assistant gunner – the assistant to the primary firer. Serves as an alternate firer.
- Ammunition bearer – one or more Soldiers who assist carrying the combat load of ammunition during combat operations.

1-27. All members of crew-served weapons teams are assigned an individual weapon. The crew-served weapon requires a complete training strategy for assigned crewmembers, including the use of available ammunition bearers, as appropriate. No crew-served weapons training and qualification takes the place of the assigned individual weapons training and qualification.

1-28. Table 1-6 provides a list of crew-served weapons by type, line number, and publication. Refer to ATP 3-21.8 for additional information concerning crew-served weapons teams.

Table 1-6. Crew-served weapons examples

| <i>Weapon</i> | <i>Weapon Type</i> | <i>LIN</i> | <i>Weapon Publication</i> |
|---|---------------------|------------|---------------------------|
| M249L | Light machine gun | M39263 | TC 3-22.249 |
| M240B | Medium machine gun | M92841 | TC 3-22.240 |
| M2A1 / M2HB | Heavy machine gun | Z00686 | TC 3-22.50 |
| MK19 | Grenade machine gun | M92362 | TC 3-22.19 |
| Legend: LIN – line item number, TC – training circular | | | |

CREW-SERVED WEAPON TABLES

1-29. The six crew-served weapon tables are—

- Table I – Preliminary Marksmanship Instruction and Evaluations.
- Table II – Pre-Live-Fire Simulations.
- Table III – Drills.
- Table IV – Basic.
- Table V – Practice.
- Table VI – Qualification (Live-Fire Proficiency Gate).

1-30. Some crew-served weapons tables include subcomponents that serve as control mechanisms during the event or provide training requirements for additional capabilities. There are two primary subcomponents to crew-served weapons tables—

- Stages – define specific capabilities that require specific training: visibility, chemical environment, and optical or sensor assistance. Stages may require multiple phases (see below) to accomplish the desired training outcomes or proficiency. Not all training events require the use of stages. The stages are a means of describing the conditions of the firing environment, typically by visibility, chemical environment, and optical assistance. The common stages for individual weapons are—
 - Day fire.
 - Day fire, CBRN.
 - Assisted night fire.
 - Assisted night fire, CBRN.
- Phases – are defined as changes to the training event where specific firing postures, level of stability, or mechanical engagement techniques require the firer to demonstrate proficiency. Not all tables include separate phases. The common phases to a table are based on the required firing positions:
 - Prone, free gun.
 - Prone, search and traverse.
 - Seated, free gun.
 - Seated, search and traverse.
 - Standing (fighting position), free gun.
 - Standing (fighting position), search and traverse.

1-31. Table 1-7, on page 1-10, shows an example of the general table structure with stages and phases for heavy machine guns. It provides an example of how stages and phases are used in the training strategy.

Note. The light and medium machine guns may not have the same stages and phases associated with their training strategy. Those weapons may use a bipod and a tripod for stability (phases) in certain events. Phases that use the tripod may include a mechanical engagement technique, where a bipod phase will not.

Table 1-7. Heavy machine gun, Table VI, Qualification, use of stages and phases, example

| Stage | Phase | | | | | |
|-------------------------------|-------------------|--------------|--------------------|---------------|----------------------|-----------------|
| | Prone Free Gun | Prone S&T | Seated Free Gun | Seated S&T | Standing Free Gun | Standing S&T |
| Day Fire | | X | | X | | X |
| Day Fire, CBRN | X | | X | | X | |
| Night Fire, assisted | | X | | X | | X |
| Night Fire, assisted, CBRN | X | | X | | X | |

Legend: CBRN – chemical, biological, radiological, and nuclear, S&T – search and traverse

SPECIAL PURPOSE WEAPONS

1-32. Special purpose weapons include a weapon, munition, or system operated by a designated Soldier in a team or squad. These items may or may not be listed on the unit's TO&E or MTOE but are available enablers for the formation. Special purpose weapons do not take the place of any individual weapons. Table 1-8 provides a list of special purpose weapons for the purposes of this manual.

Table 1-8. Special purpose weapons examples

| Weapon | Weapon Type | LIN | Training Publication |
|--------------|-----------------------------------|------------------|----------------------|
| FMG-138 | Missile (Javelin) | C60750 | TC 3-22.37 |
| AT-4CS | Shoulder-launched munition | RB4003 | TM 3-23.25 |
| M203 M320 | Grenade launcher, low velocity | L69080 | TM 3-22.31 |
| M26 | Shotgun | S40541 | TC 3-22.12 |
| M67 | Hand grenade | J77552 J78653 | TC 3-23.30 |

Legend: LIN – line item number, TC – training circular. TM – technical manual

1-33. The special purpose weapons will follow the same training path as other weapons; however, most of these items will not have a simulations system associated with them. Units must reference the appropriate training publication to understand the training tables available for each weapon or munition.

1-34. Special purpose weapons are predominantly designated to a small unit, and the small unit identifies a Soldier in the organization to train and qualify on the item. For reporting purposes, units should make every attempt to train and qualify additional personnel to ensure they maintain the qualification requirements on those special purpose weapons.

SPECIAL PURPOSE WEAPONS TABLES

1-35. The six special purpose weapons tables are—

- Table I – Preliminary Marksmanship Instruction and Evaluations.
- Table II – Pre-Live-Fire Simulations.
- Table III – Drills.
- Table IV – Basic.
- Table V – Practice.
- Table VI – Qualification (Live-Fire Proficiency Gate).

1-36. Some special purpose weapons tables include subcomponents that serve as control mechanisms during the event or provide training requirements for additional capabilities. There are two primary subcomponents to special purpose weapons tables—

- Stages – define specific capabilities that require specific training: visibility, chemical environment, and optical or sensor assistance. Stages may require multiple phases (see below) to accomplish the desired training outcomes or proficiency. Not all training events require the use of stages. The stages are a means of describing the conditions of the firing environment, typically by visibility, chemical environment, or optical assistance. The common stages for special purpose weapons are—
 - Day fire.
 - Day fire, CBRN.
 - Night fire.
 - Night fire, CBRN.
 - Assisted Night Fire.
 - Assisted Night Fire, CBRN.
- Phases – are defined changes to the training event where specific firing postures, level of stability, or mechanical engagement techniques require the firer to demonstrate proficiency. Not all tables include separate phases. The common phases to a table are based on the required firing positions:
 - Prone.
 - Kneeling.
 - Seated.
 - Standing (fighting position).

1-37. Table 1-9, on page 1-12, shows an example of the general table structure with stages and phases for shoulder launched munitions. It provides an example of how stages and phases are used in the training strategy.

Table 1-9. Shoulder launched munitions, Table VI, Qualification, use of stages and phases, example

| Stage | Phase | | | |
|--|-------|----------|--------|----------|
| | Prone | Kneeling | Seated | Standing |
| Day Fire | X | X | X | X |
| Day Fire, Chemical, biological, radiological, and nuclear (CBRN) | | | X | |
| Night Fire | X | X | X | X |
| Night Fire, CBRN | | | X | |
| Night Fire, assisted | X | X | X | X |
| Night Fire, assisted, CBRN | | | X | |

TRAINING STRATEGY EXECUTION

1-38. The individual training strategy is designed to minimize training time, while maximizing resources and training outcomes for the Soldier. This is done by grouping the prerequisite events and the live-fire events for training in a single training day each, requiring two complete training days. Conducted separately, the training strategy requires 4.5 training days to complete it to standard.

1-39. Prerequisites to Live Fire – consist of the following training events—

- Table I, Preliminary Marksmanship Instruction and Evaluation (known as PMI&E).
- Table II, Preliminary Live-Fire Simulations (known as PLFS).
- Table III, Drills.

Note. Table III, Drills, should be used during the live-fire events as concurrent training. The tasks conducted during the drills are directly related to the conduct of fire and conduct of the range.

1-40. Live-Fire events – for individual weapons training consist of the following—

- Table IV, Basic.
- Table V, Practice.
- Table VI, Qualification.

Note. Although Table V is not required, it provides an increased tempo engagement sequence that gives the Soldier additional repetitions with immediate action drills during firing. This table is specifically designed to train the Soldier on critical employment skills at a demanding and rigorous pace that is significantly more challenging than the qualification course of fire.

UNIFORM REQUIREMENTS

1-41. Marksmanship instruction requires keeping Soldiers focused on the training tasks during all preparatory training tasks. Commanders select the appropriate minimum uniform to reduce or eliminate

distractions for the Soldiers based on their experience level and the tasks trained. The following guide is the minimum uniform requirements during weapons training through qualification.

- Table I – Duty uniform.
- Tables II - VI – Combat uniform, personal protective equipment (PPE) and fighting, load carrying as directed by the commander.

1-42. Commanders ensures all firers on the qualification course of fire have access to the appropriate load carrying equipment, including magazine / ammunition pouches, magazines, holsters, slings, or any other weapon specific items. Where Soldiers are not authorized the equipment, the tasked range officer in charge coordinates for sufficient items for the firers use during training.

PREREQUISITES TO LIVE FIRE

1-43. The prerequisites to live fire are events designed to reinforce the Soldier’s knowledge of the weapon, conduct of fire, weapons safety, ammunition, engagement techniques, immediate action, and other tactical employment skills. These events are completed between T-6 through the live-fire training density execution.

1-44. The unit is required to maintain the training records for these events for 12-months, and must have the ability to access them during the live-fire event. The official record of training may not be required for upload to the Digital Training Management System (DTMS).

1-45. There are three prerequisite events within the individual weapons training strategy: PMI&E, PLFS, and drills. Additional information is provided in the respective weapon’s training appendix. A brief overview of these tasks follows.

Individual Weapons, Table I, Preliminary Marksmanship Instruction and Evaluation

1-46. Individual Weapons, Table I, PMI&E, is a pre-live fire, hands-on evaluation of the Soldiers’ demonstrated performance on weaponry tasks, characteristics, capabilities, and function of their assigned individual weapon. It verifies the Soldier’s ability to perform critical tasks, apply immediate and remedial action, and employ the weapon safely during training and tactical operations. During Table I, Soldiers must demonstrate proficiency on individual tasks and skills through testable (written) and performance (hands-on) evaluation.

Note. Successful completion of Table I, PMI&E, is required prior to any live-fire event with the weapon.

Commanders may include additional tasks, skills, or drills to the event that directly relate to their desired training objectives. This includes adding specific drills for Soldiers assigned a weapon type for the first time.

Individual Weapons, Table II, Preliminary Live-Fire Simulations

1-47. Individual Weapons, Table II, PLFS, is a simulations-based demonstration of the Soldiers’ performance while applying the primary capabilities of their weapon in a virtual environment. Table II is the culminating event for the weapon’s simulations training strategy. Table II is a replication (simulation) of the weapon’s live-fire qualification course and provides a measured demonstration of the Soldier’s performance prior to any live-fire event with the weapon.

Note. Table II is commonly referred to as a gate to live fire (known as GTLF). Successful completion of Table II, PLFS, is required prior to any live-fire event with the weapon.

Individual Weapons, Table III, Drills

1-48. Individual Weapons, Table III, Drills, is a live environment, hands-on training event using training aids and devices, and may include the use of blank ammunition. Table III is used to train and evaluate the

Soldier’s ability to execute critical tasks using their assigned weapon and equipment, during day and night conditions, and when operating in a CBRN environment.

Note. Successful completion of Table III, Drills, is required prior to any live-fire event with the weapon. Failure to conduct Table III will dramatically hinder the Soldiers ability to successfully qualify their weapon system. Table III may be executed as concurrent training on all live-fire events (Tables IV through VI).

1-49. Drills are provided in the Soldier’s tactical employment publication. These drills listed in the weapon’s manual are reinforced during the training strategy. For example, table 1-10 shows the drills crosswalk of those listed in TC 3-22.9 as they are initially trained and reinforced across the training strategy.

Table 1-10. Individual weapons drills crosswalk

| <i>Task / Drill</i> | <i>I</i> | <i>II</i> | <i>III</i> | <i>IV</i> | <i>V</i> | <i>VI</i> |
|--|------------------|-------------|---------------|--------------|-------------|-------------|
| | <i>PMI&E</i> | <i>PLFS</i> | <i>DRILLS</i> | <i>BASIC</i> | <i>PRAC</i> | <i>QUAL</i> |
| Weapons check | T | R | R | | | |
| Sling / unsling | | | T | | | |
| Equipment check | T | R | R | | | |
| Load | T | R | R | R | R | R |
| Carry | T | | R | R | R | R |
| Firing positions (4 primary positions) | T | R | R | | R | R |
| Fight down (standing – kneeling – prone) | | | T | | R | R |
| Fight up (prone – kneeling – standing) | | | T | | R | R |
| Go-to-prone (standing – prone) | | | T | | R | R |
| Reload | T | R | R | R | R | R |
| Clear malfunction | T | R | R | | R | |
| Unload / show clear | T | R | R | R | R | R |

Note: Table V, Practice, includes the use of DDI or expended brass to induce a malfunction (failure to fire) the Soldier must overcome. (Highlighted in orange shading)

Legend: DDI - dummy, drilled, inert, PLFS - preliminary-live-fire simulations, PMI&E - Preliminary Marksmanship Instruction and Evaluation, PRAC - practical, QUAL - qualification, R - Reinforced - a deliberate use of the drill during the training event, T - Trained and Evaluated - the first instance of training the drill within the training strategy

1-50. For maximum efficiency and throughput, units should consider conducting the prerequisites in round-robin fashion. Table 1-11 shows the prerequisite training rotation.

Table 1-11. Prerequisites round-robin example

| Station | Event | Soldiers per Station | Rotation Schedule | Throughput Schedule |
|---------|--|----------------------|-------------------|--|
| 1 | Table I, Preliminary Marksmanship Instruction and Evaluation (PMI&E) | 20 | 1 hour | 60 Soldiers 3 hours or 120 Soldiers 6 hours or 180 Soldiers 9 hours |
| 2 | Table II, Preliminary-Live-Fire Simulations (PLFS) | 10 firers | 1 hour | |
| | | 10 coaches | | |
| 3 | Table III, Drills | 10 Soldiers | 1 hour | |
| | | 10 coaches | | |

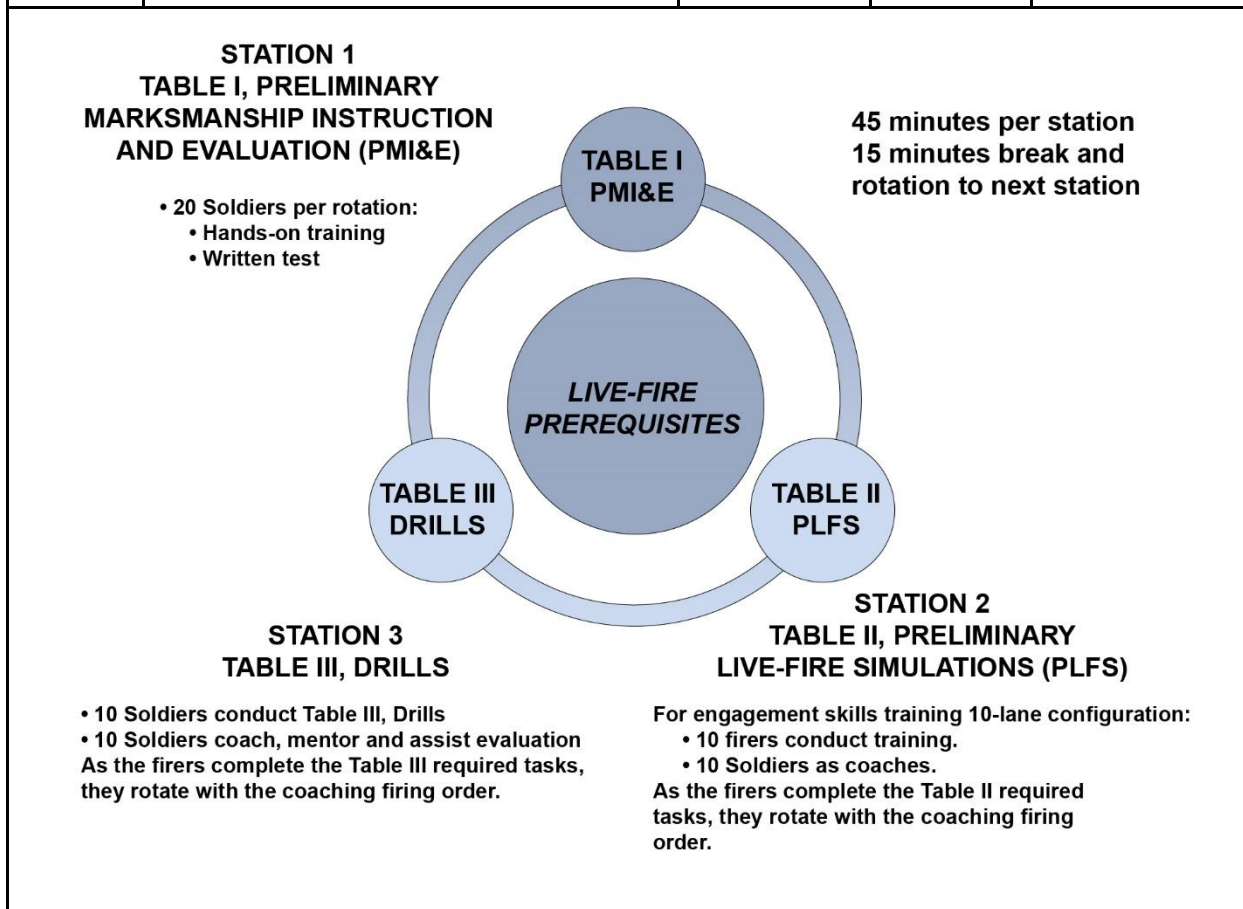

Note: Each station requires two noncommissioned officers who are weapon system qualified. Trainers should complete the prerequisites (eight-step training model).

Soldiers assigned a weapon type for the first time must conduct Table III prior to Table II in order to build proficiency on the critical tactical employment skills.

1-51. Commanders have the option to allow their Soldiers who are competent and proficient with their weapon system to test out on prerequisites to live-fire. The intent of the prerequisites is to mitigate risk for the commander. The prerequisites (Tables I, II, and III) allow any Soldier to move directly to the test point:

- Table I, PMI&E; complete a short, 20 question test.
- Table II, PLFS; successfully qualify under the simulated qualification course of fire.
- Table III, Drills; demonstrate proficiency to ensure the Soldier can meet the time requirements enabling the Soldier's successful completion of Table VI.

LIVE-FIRE EVENTS

1-52. The live-fire events include the full-caliber or subcaliber training events that are conducted in the live environment under live-fire conditions. They may not be conducted by any Soldier who has not successfully completing the prerequisites to live-fire between T-6 and execution of the first live-fire event conducted in the training density.

1-53. The live-fire events are designed to give the unit flexibility by providing multiple types of authorized range facilities that can accommodate the training. Live-fire events also provide a minimal amount of time per firing order while maintaining the highest number of repetitions through the core capabilities of the weapon system.

1-54. There are three live-fire events with the individual weapons training strategy: basic, practice, and qualification. Additional information is provided in the respective weapon's training appendix. A brief overview of these events follows.

Individual Weapons, Table IV, Basic

1-55. Individual Weapons, Table IV, Basic, is a course of fire using training ammunition on an authorized live-fire facility. This table trains basic skills at a reduced tempo to ensure Soldier mastery of specific basic weapon employment skills. This table builds upon those skills trained and tested during Tables I, II, and III.

1-56. This table includes execution of critical skills in a live environment under live-fire conditions. Table IV is commonly the first training event where the Soldier employs the weapon with training ammunition against prescribed targetry to a defined standard.

Note. Table IV is required prior to conducting Table VI, Qualification, for all individual weapons.

Individual Weapons, Table V, Practice

1-57. Individual Weapons, Table V, Practice, is a course of fire using training ammunition on an authorized live-fire facility. This table reinforces the basic skills trained during previous events but increases the tempo to expected engagement sequence capabilities to build Soldier mastery. Table V is designed to be more difficult than the qualification course of fire to build confidence in the weapon, ammunition, optics, and training.

1-58. This table includes execution of critical skills in a live environment under live-fire conditions. Table V prepares the Soldier to employ the weapon against most common threat scenarios using prescribed targetry sequences to a required standard.

Note. Although Table V is not required, it provides an increased tempo engagement sequence that gives the Soldier additional repetitions with immediate action drills during firing. This table is specifically designed to train the Soldier on the critical employment skills at a demanding and rigorous pace that is significantly more challenging than the qualification course of fire.

Individual Weapons, Table VI, Qualification

1-59. Individual Weapons, Table VI, Qualification, is the Army-standard record course of fire used to determine the live-fire proficiency of a Soldier employing the weapon. This table includes execution of critical skills. The qualification course of fire uses training ammunition on an authorized live-fire facility, in a live environment, under live-fire conditions. Table VI builds Soldier experience by tactically employing the weapon against most common threat scenarios with their assigned equipment and attachments. As a live-fire proficiency gate, it provides the commander with an assessment of the Soldier's overall proficiency in employing the weapon.

1-60. For maximum efficiency and throughput, units should consider conducting the live-fire events on one range facility or two ammunition range footprints. This allows the unit to complete all live-fire events through qualification in one training day for up to 200 or more Soldiers.

1-61. Table 1-12, on page 1-18, provides an example of a unit occupying one range facility, conducting rifle and carbine, Tables IV, V, and VI, in one training day. The throughput information used below is provided in the rifle and carbine appendix. In this example, the unit can train through qualification for 240 Soldiers in one training day on one range facility.

Note. The use of dummy, drilled, inert (known as DDI) to reinforce weapons manipulation may not be used on any Table VI event for any weapon.

Table 1-12. Live-fire events using a single range on one training day example

| <i>Event</i> | <i>Number of Lanes Available</i> | <i>Number of Firing Orders</i> | <i>Throughput Schedule</i> | <i>Time Between Events</i> | <i>Time Required</i> | <i>Training Schedule</i> |
|--------------------------------|----------------------------------|--------------------------------|----------------------------|----------------------------|---------------------------|-----------------------------|
| Table IV, Basic | 16 | 15 | 4 hours | 30 minutes | 4 hours 30 minutes | 0800-1230 |
| Table V, Practice | 16 | 15 | 2 hours | | 2 hours | 1230-1430 |
| Table VI, Qualification | 16 | 15 | 2 hours 15 minutes | | 2 hours 15 minutes | 1430-1645 |
| | | | | | 8 hours 45 minutes | 240 Soldiers trained |

Table IV, Basic

- 16 lanes
- 15 firing orders
- 15 minutes per firing order
- 240 Soldiers trained
- 30 minutes to reset range

- 4 hours, 30 minutes total

30 minutes provided to remove target frames from the 25-meter boots. This must be done between Table IV and Table V to ensure line of sight is maintained for the practice course of fire.

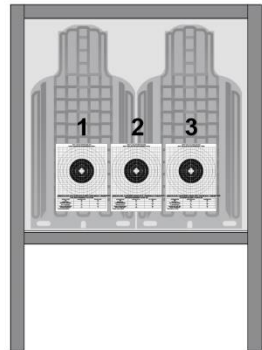

Time between each firing order (time required to replace one firing order with the next) is 5 minutes for each event.

Units may reduce this time requirement by pre-positioning the next firing order behind the firing line. This allows coaching of the firer when appropriate.

Table V, Practice

- 16 lanes
- 15 firing orders
- 240 Soldiers trained

- 2 hours total

There is no range reset time between Table V and Table VI.

Table VI, Qualification

- 16 lanes
- 15 firing orders
- 240 Soldiers trained

- 2 hours, 15 minutes total

Note: In this example, 5 minutes is used between each firing order. Thirty minutes is used to remove the target frames for zeroing off the range.

INDIVIDUAL WEAPONS QUALIFICATION STANDARDS

1-62. Qualifications are the Army’s standard demonstration of proficiency of a weapon, system, platform, or small unit, as defined in the appropriate training publication. Qualifications are the required live-fire proficiency gates that enable a Soldier to progress to higher echelon live-fire collective events.

Note. All qualifications and certifications are valid for 12 months. The length of time the qualification or certification is valid is the “qualification duration (known as QD).”

1-63. Qualifications may be used as prerequisites for additional training, certifications, or functional courses. Qualifications are externally evaluated by a certified leader, typically the range officer in charge (OIC) or range noncommissioned officer in charge (NCOIC). The Soldier’s commander verifies the qualifications and endorses them prior to entry in DTMS.

1-64. Soldiers must meet the qualification requirements listed in the appropriate weapons appendix. The unit tasked to conduct the event is responsible for recording the respective Table VI, Qualification results on the designated Department of the Army form. The unit is responsible for annotating the results of their Soldiers’ qualifications in the DTMS for tracking, reporting, and accountability purposes.

1-65. The Army standards for individual weapons qualifications and any associated marksmanship badges and clasps are listed in table 1-13. The specific task, conditions, and standards for each weapons qualification and certification are detailed in the respective appendix at the end of this publication.

Table 1-13. Army-standard individual weapon, Table VI, Qualification requirements

| <i>Qualification Rating</i> | <i>Pistol (30 targets)</i> | <i>Rifle / Carbine (40 targets)</i> | <i>Automatic Rifle (40 targets)</i> | <i>Sniper (200 points)</i> |
|--|--------------------------------|---|---|--------------------------------|
| EXPERT | 27 to 30 | 36 to 40 | 36 to 40 | 180 to 200 |
| SHARPSHOOTER | 24 to 26 | 30 to 35 | 32 to 35 | 160 to 179 |
| MARKSMAN | 21 to 23 | 23 to 29 | 28 to 31 | 140 to 159 |
| UNQUALIFIED | < 21 | <23 | < 28 | < 140 |
| Authorized Clasp: | PISTOL | RIFLE / CARBINE | AUTO RIFLE | RIFLE |
| <p>Notes. Sniper weapon systems use a precision-based point system rather than targets hit or targets presented. For qualification courses of fire that include multiple stages in simulation, the firer must also achieve a “GO” rating in simulations on each. If the simulation stage is incomplete or failed, the Soldier’s rating is unqualified. Soldiers are not authorized to make multiple attempts during the training period to increase their qualification rating. Soldiers are not authorized subsequent attempts on the same day. The next opportunity to requalify is during the unit’s designated retraining window, which is no earlier than 45 days from the first attempt. Soldiers making multiple attempts to qualify during a 45-day period may only be awarded the marksman rating.</p> | | | | |
| Legend: < - less than | | | | |

CONDEMNATION CRITERIA

1-66. Condemnation criteria (known as CC) are a common set of rules or conditions that apply to any qualification or certification. When those conditions are triggered, the qualification or certification expires. For individual, crew-served, and special purpose weapons, the three distinct rules of condemnation criteria are time, key leader turnover, or commander's assessment. All qualifications and certifications are valid unless one of the following condemnation criteria exist—

- Time – twelve months have elapsed since the date of the qualification or certification was completed.
- Key leader turnover – for the purposes of individual, crew-served, and special purpose weapons, key leader turnover is when a qualified Soldier is no longer assigned to the organization, or the qualified Soldier is no longer assigned the weapon.
- Commander assessment – the evaluation commander two levels higher determines the subordinate unit's proficiency is no longer at a trained level.

1-67. There are two distinct beneficiaries of each individual, crew-served, or special purpose qualification: the Soldier and the commander. The Soldiers' weapons qualifications are recorded in their individual training record. The commander uses current qualifications to account for training readiness reporting requirements of assigned Soldiers with assigned weapons.

SOLDIER QUALIFICATION DURATION

1-68. Soldiers' weapons qualifications are recorded in their individual training record in the DTMS. If the qualifications and certifications are still valid and no condemnation criteria have been triggered, the Soldier maintains those qualifications regardless of whether they are currently assigned the weapon or weapon system.

1-69. The Soldier qualification condemnation criteria are—

- Time – Twelve months have elapsed since successfully completing the qualification.
- Commander assessment – Any commander in the chain of command determines the Soldier no longer maintains weapon proficiency for any reason.

COMPANY-LEVEL QUALIFICATION DURATION

1-70. The purpose of qualification or certification for the commander is—

- To provide a risk mitigation tool to ensure the Soldier who is assigned the weapon is competent and proficient when employing it.
- To ensure the Soldiers are receiving the adequate training to gain experience through repetition and varying engagement scenarios.
- To assist in determining the lethality of subordinate firers in relation to the lethality of the larger unit.

1-71. Commanders can increase their weapons qualifications when newly assigned Soldiers, whose qualifications are valid on a weapon type, are assigned the weapon type. This allows the commander to leverage the Soldiers' qualifications through talent management.

1-72. For reporting purposes at the company level, the qualification condemnation criteria for individual weapons are—

- Time – Twelve months have elapsed since successfully completing the qualification.
- Key leader turnover—
 - Company-size units may not consider a Soldier qualified on a weapon type that the Soldier is not assigned.
 - Soldiers reassigned to another organization retain their qualification for the weapon type as part of their individual training record; however, the gaining company-level organization assumes responsibility of the qualification and may not count the qualification for reporting purposes until the Soldier is assigned that weapon type.

- Commander assessment – Any commander in the chain of command determines the Soldier no longer maintains weapon proficiency for any reason.

QUALIFICATION REFIRES

1-73. Qualification of any weapon tests the Soldier's abilities to employ the weapon effectively. The manual does not state that multiple attempts cannot be made, but it does restrict the Soldier's rating when they require multiple attempts.

1-74. Refires are authorized with realistic and reasonable guidelines. Refires–

- Must wait 45 days to INCREASE their qualification rating.
 - Expert Infantry Badge (known as EIB) training and testing – units provide sufficient time and resources to enable the appropriate retraining and refiring.
 - Promotion points – Soldiers may not use multiple attempts within 44 days of the first attempt to increase their potential promotion points awarded.
 - Department of the Army photos – Soldiers may not use multiple attempts within 44 days of the first attempt to increase their qualification rating.
- Retraining and refiring may occur the same day; however, the Soldier may only be awarded the marksman qualification badge for the weapon.
- Refires within 44 days of the last attempt receive the marksman qualification rating only.

1-75. This provides a better commander assessment on the overall proficiency of their Soldiers and the effectiveness of their past UTPs. The first attempt results of qualification reinforce the training strategy's overall effectiveness, and reinforce unit's use of the entire strategy. Firing multiple attempts does not build a better shooter.

INDIVIDUAL WEAPON VALIDATION

1-76. Validation is a commander's option to execute the Army-standard qualification to the minimum threshold requirements to validate an existing qualification—not to create a new qualification rating. Where validation events are authorized, the threshold requirements are defined in the weapon's appendix. The validation event is used in extreme circumstances where the commander requires confirmation of a qualification or certification. These circumstances may arise in garrison and operational environments.

GARRISON REQUIREMENT

1-77. The validation event is completed using the alternate course of fire (known as ALT-C) as described in the respective appendix. The following rules apply to validation events for use in garrison:

- The first general officer in the unit's chain of command authorizes the use of the validation event.
- Unit assigned as quick reaction force within 90 days.
- Unit directed to deploy within 90 days without prior notice.
- Installation range restrictions prohibit standard qualification due to range closures, ammunition restriction, or unforeseen circumstances beyond the control of the unit.
- Unit location is greater than 180 miles from an Army-standard primary range facility.
- Only one validation is authorized within a 24-month period for any weapon, system, or munition.
- Successful completion of the validation event extends the existing QD by 12 months.
- Failure to successfully complete a validation event after two attempts condemns the qualification immediately.
- Failure to validate requires the Soldier to complete the full training strategy to regain their qualification status.

Note. Failing to request or secure appropriate training facilities, ammunition, or other resources does not justify the use of any validation procedure at home station.

OPERATIONAL REQUIREMENT

1-78. The first general officer in the unit's chain of command may authorize subordinate units to exercise the validation event when deployed to austere environments when one of the following conditions exist:

- Available range facilities do not support the Army-standard qualification requirements.
- Local range regulations prohibit firing the ammunition type, standard engagement techniques, or do not support the surface danger area.
- The training area available does not meet the most stringent range safety regulations of the Army or host nation where the composite surface danger zone (known as SDZ) cannot be sufficiently maintained and secured.

1-79. The validation event is completed using the alternate course of fire (known as ALT-C) as described in the respective appendix.

Note. Not all weapons have an authorized validation event or process. Units must refer to the weapon's appendix for additional information.

1-80. The following rules apply to validation events for operational units while deployed:

- The first general officer in the unit's chain of command authorizes the use of the validation event.
- The event may only be executed 90 days after mission start through 30 days before mission complete.
- Successful completion of the validation event extends the existing QD by 12 months.
- Only one validation is authorized within a 24-month period for any weapon, system, or munition.
- Failure to successfully complete a validation event after two attempts condemns the qualification immediately.
- Failure to validate requires the Soldier to complete the full training strategy to regain their qualification status.

1-81. Prior to planning, preparing, or executing the ALT-C for reporting (validation) purposes, units must ensure the Soldiers expected to conduct the training are authorized.

CERTIFICATIONS

1-82. For the purposes of individual weapons, certifications are weapons training to a specific quantifiable measure beyond the Army-standard qualification that enables the weapon's employment at an advanced level or to specific manner, use, or technique. Any Soldier conducting a certification must be weapon system qualified.

1-83. Certifications follow the rules of the QD, including the CC. Units are responsible for managing certifications, as required.

1-84. Certifications may be used as a prerequisite for additional training, certifications, or functional courses. Units may create their own certification programs to enhance their organization's tactics, techniques, and procedures, collective training, and other events to mitigate risk during complex live-fire events.

Note. For example, after completing the M4 Army-standard qualification (Table VI), a unit trains and certifies its firers on urban rifle marksmanship (known as URM). Once successfully completed, firers are certified on that advanced skill.

That URM certification is the prerequisite to training in a live-fire shoot house facility.

1-85. Certifications may be listed in an appendix for a weapon but may be unit developed. Table 1-14 lists some common certifications for individual, crew-served, and special purpose weapons.

Table 1-14. Common individual weapons certification examples

| Weapon | Certification | Appendix | Unit Developed |
|---|--------------------------------|----------|----------------|
| M4 / M16, M249AR | Urban rifle marksmanship | H | |
| M4 / M16, M249AR | Assisted fire | I | |
| M4 / M16, M203 / M320 | Transition to secondary weapon | | X |
| M4 / M16 | Long range marksmanship | | X |
| M249AR | Plunging fire, grazing fire | | X |
| Legend: M249AR – automatic rifle | | | |

This page intentionally left blank.

Chapter 2

Unit Training Plans

This chapter describes the UTP and includes the commander's assessment and the training horizon. It provides information, general guidance, and best practices for developing an effective UTP for individual weapons. It includes general concepts of the IWTS and describes how to integrate critical training events into the unit's weapons training program. This chapter begins with guidelines for commanders to consider when selecting a unit training subject matter expert (SME) to advise and assist during the planning, preparation, execution, and assessment of small unit weapons training. It describes the SME's duties and responsibilities at various echelons and highlights the skills and attributes they provide to the Soldiers and leaders within the organization.

MARKSMANSHIP MASTER TRAINER

- 2-1. The unit must have a knowledgeable SME on the various individual, crew-served, and special purpose weapons, systems, optics, pointers, lasers, and attachments. A marksmanship master trainer (known as MMT) is an institution-trained and certified Soldier on small arms weapons, ammunition, maintenance of weapon systems, and the various weapon's unit training programs. These courses include, but are not limited to, the MMT course and the heavy weapons leader course. MMT instruction focuses on either individual or crew-served weapons to build weapons proficiency within any organization.
- 2-2. The MMT specializes in developing, coordinating, executing, and evaluating UTPs. They have a detailed understanding of the individual and crew-served weapons training strategies and are skilled at training small unit leaders on how to teach marksmanship skills for those weapons.
- 2-3. For units that do not have a MMT assigned or authorized, the commander should select an experienced noncommissioned officer (NCO) who has clearly demonstrated a high level of proficiency training and experience in employing weapons and small units. Typically, the selected Soldier will perform the functions of the MMT as an additional duty.

Note. For simplicity and standardization, the term "MMT" is used throughout this manual to identify a Soldier serving as the unit's individual and crew-served weapons SME who will develop, manage, and provide oversight on the weapons, systems, or small unit training programs for the commander. This assigned duty does not remove or replace the roles and responsibilities of the leadership, staff, or chain of command during planning, preparation, or execution of training.

- 2-4. The mission of the MMT is to plan, prepare, execute, and assess the unit's direct fire training and serve as the SME for all individual and crew-served weapons and systems in the unit. The MMT advises the commander on all aspects of direct-fire training, capabilities, tactics, and employment.
- 2-5. Unit commanders and staff must be familiar with what their MMT provides in garrison, during training, and while deployed. The MMT duties and responsibilities are to—
 - Develop and implement live-fire training standard operating procedures (SOPs).
 - Track weapons, armament, sensor maintenance tasks, and advise the commander on their status.
 - Maintain weapon systems firing data.
 - Train and certify live-fire evaluators (individual weapons, crew-served weapons, and special purpose weapons).

- Assist subordinate units with direct-fire planning, training, and employment.
- Forecast and manage ammunition through the Training Ammunition Management Information System (known as TAMIS). Manage ammunition accounts for all subordinate units.
- Resource and request training areas and range facilities through the Range Facility Management Support System (known as RFMSS).
- Manage direct-fire training documents, records, and rosters.
- Develop, coordinate, and oversee tactical and direct-fire skills training, and assess the tactical and direct-fire training results.
- Coordinate the pickup, training, installation, use, troubleshooting, and turn-in of all TADSS required to conduct effective weapons and small unit direct-fire training.
- Develop and manage simulations and virtual systems to support the unit training program.
- Conduct train-the-trainer or user training on TADSS device-based systems (for example, installation, boresighting, and troubleshooting procedures, use, and maintenance).
- Assist the commander with oversight of all live-fire training before, during, and after execution.
- Ensure live-fire training standards are maintained and sustained.
- Advise the commander of the tactical capabilities and limitations of all weapons, systems, and platforms against anticipated or expected threats, in collaboration with the battalion intelligence staff officer (S-2).

2-6. The MMT's formal training includes extensive training in range planning, preparation, execution, and in all phases of live-fire training. The MMT has additional responsibilities at various echelons at home station and during deployments:

- Division MMT's responsibilities are to—
 - Design and safely certify sustainment training ranges while deployed.
 - Develop installation range upgrade and modernization assessments and provide recommendations for major construction and other projects to the division operations staff officer.
 - Coordinate with U.S. and foreign military representatives for joint and international live-fire exercises or events.
 - Develop and recommend live-fire actions, goals, and requirements for inclusion in the commander's training guidance.
 - Develop division-level gunnery standard operating procedures (known as GUNSOP).
 - Provide small arms SME advice to the commanding general and division operations staff officer.
 - Advise the commanding general on small arms densities and live-fire proficiency training gaps, strengths, weaknesses, and recommend appropriate corrective actions.
 - Provide oversight of TADSS use, instruction, and management in the division.
 - Consolidate brigade live-fire training, qualification, and proficiency results for analysis, assessment, and recommended corrective courses of action.
 - Conduct quarterly MMT coordination and collaboration meetings to ensure compliance with division guidance, standards, and training strategies.
 - Oversee and deconflict training resources—ammunition allocations, training areas and land, simulations, TADSS, ranges, and training facilities—in coordination with the appropriate installation agencies.
 - Consolidate, review, and validate all MMT school candidate packets.
 - Establish MMT training and mentorship program in the division.
 - Provide direct-fire training SME assessments during predeployment sight survey activities.
 - Develop and oversee all small arms accuracy, and zeroing procedures during reception, staging, onward movement, and integration functions, as appropriate.
 - Serve as the commanding general's representative for all live-fire discussions during division, Army command, Army, and international conferences and work groups.

- Oversee and manage combat and training ammunition accounts for the subordinate units and divisional assets when deployed, in coordination with the division ammunition officer.
- Brigade MMT's responsibilities are to—
 - Work closely with the subordinate unit SMEs to ensure standards are uniform throughout the brigade's weapons training programs.
 - Mentor subordinate unit MMTs and SMEs on UTPs, evaluation procedures and practices, and other weapons-related topics.
 - Collect, identify, and provide any new information, best practices, or procedures to improve live-fire training and lethality.
 - Coordinate with range operations personnel at the installation or major training area, as needed.
 - Assist range operations to develop and upgrade range facilities based on identified training gaps.
 - Deconflict scheduling or use of training assets in the brigade.
 - Maintain brigade-level TAMIS and RFMSS accounts and assist subordinate unit account users.
 - Create consolidated unit live-fire proficiency reports upon completion of each live-fire training density. Identify training gaps, weaknesses, strengths, and overall unit proficiency for the brigade commander and brigade operations staff officer (S-3).
 - Develop and oversee the creation and construction of sustainment training ranges, as required when deployed.
 - Manage combat and training ammunition accounts and assist subordinate units, when deployed, in collaboration with the division and brigade ammunition officers, as needed.
- Battalion MMT's responsibilities are to—
 - Collaborate with the unit staff to develop comprehensive collective training events, exercises, and evaluations.
 - Train and mentor the unit's subordinate MMTs, SMEs, and NCOs on weapons-related topics.
 - Assist the battalion commander and command sergeant major select candidates for MMT courses.
 - Track safety of use messages, ammunition information notices, and maintenance messages that impact live-fire weapons training.
 - Develop and implement new training techniques, practices, procedures, and methods to improve live-fire training and unit lethality.
 - Coordinate with brigade for direct-fire training assets, opposing force(s), TADSS, and other items in support of tactical and live-fire training events.
 - Certify individual weapons, crew-served weapons evaluators, and coaches.
 - Coordinate and manage unit personnel to complete the required installation or training location range safety officer (known as RSO), OIC, or NCOIC instruction and certification.
 - Manage the unit's ammunition, land, and range resourcing accounts through TAMIS and RFMSS.
 - Monitor company-level live-fire UTPs.
 - Develop battalion-level live-fire UTPs.
 - Consolidate unit live-fire training records to meet regulatory, installation, or training location requirements.
 - Provide analysis to the commander on unit proficiency, training gaps, weaknesses, strengths, and overall unit performance.
 - Provide assistance for direct-fire planning while deployed.
 - Develop and manage sustainment ranges during deployments.
 - Develop surface danger area diagrams, composite SDZs, and weapons danger zones for home station and deployed locations.

- Company MMT’s responsibilities are to—
 - Develop unit direct-fire training programs and manage resources to facilitate company-level live-fire training plans.
 - Assist and oversee armament system maintenance and services, as appropriate.
 - Work with unit maintenance to correct weapon or system malfunctions or deficiencies, as appropriate.
 - Complete and maintain DA Form 2408-4 (*Weapon Record Data*) on all required weapons, to include sniper rifles (hard copy or online, as appropriate).
 - Coordinate with the battalion S-3 and battalion MMT to secure company live-fire training assets.
 - Train live-fire evaluators.
 - Develop, design, and create deployed live-fire training ranges, as directed.
 - Report unit live-fire training results to the higher headquarters’ MMT.
- Platoon MMT’s responsibilities, where authorized, are to—
 - Assist with maintenance supervision of the platoon armament, weapons, and systems.
 - Update the company’s unit training SME on the platoon’s live-fire training.
 - Assist the company’s unit training SME with unit live-fire training.

UNIT TRAINING PLANS AT ECHELON

2-7. The UTPs are the unit’s overarching plan to attain mission essential and collective task proficiency. Every company-level and above collective training event is created, developed, and executed using the operations process (plan-prepare-execute-assess). UTP’s are planned and coordinated in detail well before execution to ensure synchronization with the commander’s intent and expected outcomes.

2-8. The UTP includes an incremental synchronization of critical actions that must occur to support an effective, quality training event. During the planning and preparation process, the unit’s actions are described in weekly or monthly increments prior to training execution, depending on the unit’s component.

2-9. The concepts of the “T-week” (Active Army) and the “T-month” (Reserves) are used to provide a sequential framework that ensures all critical actions are completed before and after the training event is conducted. This process has to start early enough in the planning cycle to ensure all resources required to train are present and accounted for as the training begins.

2-10. All unit or SME actions are described throughout this chapter in “T-increment” fashion. Active components will read the “T-increment” number in weeks, and Reserves read the same number as months. This aligns the requirements appropriately in most cases. Installation SOPs may have specific submission dates (suspense dates) that are different from those listed. Units must adjust their plan and prepare actions accordingly.

2-11. The T-increment provides the framework to demonstrate the backward planning actions, requirements, and considerations necessary for any maneuver tactical or live-fire training event. The T-increment framework is descriptive and does not take into account each unit or installation’s particular submission, verification, or lock-in requirements.

Note. The T-increment follows and supports the eight-step training model (company and below events), and the operations process (battalion and above events). It does not replace those processes and detailed planning actions of the unit.

2-12. After completing the initial unit proficiency assessment, and establishing the training goals, objectives, guidance, and requirements, the commander then designs the unit’s live-fire training plan. The commander must select an approach to training that suits their unit’s needs and that is structured for the average proficiency level of his unit.

2-13. The commander and the primary trainers must then schedule training that is challenging, rigorous, and effective. The unit must develop a training plan that provides sufficient TADSS, resources, training areas, and ranges to accomplish their objectives. Training events should be combined (sequential, simultaneous, or multi-echelon events) to maximize efficient use of resources, operating tempo, and training days available.

COMMANDER'S ASSESSMENT

2-14. Guidance from the higher headquarters commander, typically in the form of the command training guidance to the subordinate unit commanders, begins the planning process. Before developing the UTP to support that guidance, the commander must make a complete assessment of the unit's proficiency, training strengths, weaknesses, and the standards they wish to achieve. Units conduct this analysis through a complete mission analysis. This assessment must be comprehensive to best support the design of training plans that achieve, improve, or sustain the variety of skills that determine proficiency. Commanders assess and evaluate all aspects of training, including the planning, preparation, and execution. Leaders continuously monitor the unit's mission-essential task proficiency to determine a quantifiable snapshot of the unit's tactical and direct-fire proficiency. From this assessment, the unit can develop the UTP to correct deficiencies, and improve mastery.

2-15. The commander assesses the unit's Soldiers, squads, crews, mortars, and small units for overall proficiency using a variety of indicators:

- Previous training assessments.
- Key leader turbulence.
- Resources available (time, ranges, ammunition).
- Maintenance status.
- Mission-essential task assessment.
- Warfighting skills.

2-16. The commander uses the specific task standards whenever possible to measure the demonstrated abilities of Soldiers, squads, crews, and elements. Accurate, honest, and objective evaluations are necessary to identify where to place training emphasis. Leaders must make on-the-spot corrections and demand aggressive action to correct training deficiencies.

PREVIOUS TRAINING ASSESSMENTS

2-17. The unit reviews the pertinent previous training records to determine proficiency status, strengths, weaknesses, and training gaps. The unit identifies prerequisite training events and incorporates them in the unit training plan to ensure proper sequencing along the training horizon.

2-18. Commanders must be aware of the frequency of training required for each strategy. The frequency does not relate to how long the qualification is valid (termed the "qualification duration"), but the Army's expectation for that particular component or unit type to conduct the training during the fiscal or training year. The frequency of training through qualification or proficiency impacts the ability of the unit to rapidly increase its training readiness in the shortest amount of time with the least amount of training resources. The frequency of event execution is tied to ensuring the maximum amount of experience is achieved, sustained, and maintained, and is described for each weapon, system, platform, and small unit in DA PAM 350-38.

INDIVIDUAL, CREW-SERVED, AND SPECIAL PURPOSE WEAPONS ASSESSMENT

2-19. Units ensure all Soldiers have a valid qualification for their assigned, designated, and required individual, crew-served, and special purpose weapons. Qualifications are valid for 12 months, unless specifically stated otherwise in the respective training publication. All assigned, designated, or required individual, crew-served, or special purpose weapons must have a valid qualification prior to entering collective live-fire events.

2-20. Certain units have additional training requirements once individual or crew-served weapons qualification is achieved. These additional training requirements beyond the Army-standard qualification are

termed certifications. They are specific capabilities for a Soldier or team on which they must demonstrate proficiency prior to conducting high risk live-fire collective training. Examples of some certifications are—

- Thermal weapon sights. This is the boresighting, alignment, zeroing, and tactical employment of weapons equipped with various thermal optics.
- Pointers, illuminators, lasers. This is the boresighting, alignment, zeroing, and tactical employment of weapons equipped with various pointers, illuminators, and lasers.
- Transition to secondary weapon. This is the tactical employment of a primary and secondary weapon system during short range engagements. This includes transitioning from an individual weapon to a special purpose weapon, such as engagements with an M4-series carbine switching to an under-mounted 40-millimeter (mm) grenade launcher.

KEY LEADER TURBULENCE

2-21. The greatest challenge that a commander must contend with is maintaining qualified and proficient units through personnel changeover, expected or not. The commander must plan for reducing and controlling key leader turbulence to maintain overall unit readiness for the maximum amount of time. Units must actively execute talent, crew, and key leader management skills during the operations process of the UTP. Some possible mitigation techniques to personnel management challenges are—

- Continually cross-training personnel for replacements. Experienced Soldiers are easier to train than new Soldiers. Units should use harvested training ammunition to train and qualify alternate firers to build experience. Those additional qualified Soldiers provide the commander with additional flexibility managing talent at multiple echelons in their organization.
- Stabilizing trained SMEs upon graduation. Commanders can encourage attendance at the various MMT and heavy weapons leader courses with “graduate stabilization” in the unit. Leaders can maximize the unit’s investment in the Soldier’s expertise by completing unit stabilization requests. This can effectively stabilize the Soldier with the unit for up to 24 months.
- Conducting small qualification training densities. Unit may choose to conduct qualification events with sister organizations. This is extremely helpful to the unit to maintain and sustain readiness; however, it may be a significant burden on the sister unit. Advanced planning will limit the number of personnel, crews, or squads to qualify, and the unit will be able to plan for reciprocating the training capability during their UTP.

2-22. During the key leader turbulence assessment, the commander will be able to identify the most common causes, the impacts on proficiency and readiness, and identify the most probable points of failure in the current assignments of key leaders. Commanders can provide guidance to subordinate leaders on the preferred methods to mitigate future turbulence.

RESOURCES AVAILABLE

2-23. The unit must review available and forecasted training munitions, land and range facility accessibility and availability, operating tempo impacts, and other key resources prior to developing the UTP. Leaders should conduct a training area and range reconnaissance to reserve the appropriate training facility or training area that meets the commander’s training guidance, training publication guidance for the planned events, and the space to accommodate the entire unit’s personnel and equipment during the training density.

2-24. Each installation has unique conditions that directly impact their tenant units. Units must pay close attention to restrictions, limitations, or additional installation or local coordination requirements for—

- Pyrotechnics employment. Installation boundaries, seasonal restrictions, and hazards to Soldiers are key considerations during UTP development.
- Training cycle rotations. Units must consider the method they will execute the IWTS, and assess the advantages and disadvantages of each, and the impacts those methods will have on their resources.

MAINTENANCE STATUS

2-25. A review of the weapon, system, and optic maintenance status is critical to the unit's success. Units should not overlook the maintenance status of—

- Weapon systems. Units must ensure the entire weapon system's maintenance is reviewed holistically to include all the assigned additional authorized equipment, capabilities, and enablers. This includes backup sights, thermal optics, pointers, illuminators, magazines, bipods, tripods, and alignment devices.
- Thermal sensors. This includes thermal weapon sights, charging stations, rechargeable battery capacity, and required generator capabilities.
- CBRN detection equipment, protective garments and equipment, and decontamination equipment.
- Digital communications systems. This includes software versions, encryption devices, and displays. Units should conduct a digital communications exercise prior to conducting any company or higher collective training event.

MISSION-ESSENTIAL TASK LIST ASSESSMENT

2-26. Time, resources, and command emphasis must focus on training tasks that support the mission essential task list. Unit leaders should use the appropriate individual tasks that support the training objectives using the following references—

- Digital Training Management System.
- Combined Arms Training Strategy (CATS).
- Central Army Registry.
- Soldier's handbooks applicable to the training event.
- Soldier training publications (training circulars) applicable to the training event.
- DA PAM 350-38.
- Deployment or mobilization plans.
- Army, area command, and local regulations.
- Local SOP.

2-27. The training and evaluation outlines for the collective tasks, drills, and individual tasks identified that support the unit's mission-essential task list can be accessed through the DTMS, or in the CATS found on the Army Training Network website.

WARFIGHTING SKILLS

2-28. Individuals, crews, squads, and platoons must achieve proficiency on tasks that are critical to sustain and improve direct-fire training skills. These skills are inherent to training direct fire weapons and maximizing the use and employment of other warfighting functions and combined arms systems. Each warfighter must effectively—

- Move:
 - Perform individual movement techniques.
 - Navigate from one point to another.
 - Move under direct fire.
- Shoot:
 - Perform disciplined fratricide prevention.
 - Detect, identify, and classify threats.
 - Maintain, employ, and engage with assigned weapon or weapon system.
 - Employ hand grenades.
 - Call for fire.
 - Call for support (close air support, attack aviation, mounted vehicle).
- Communicate:

- Perform voice communications.
- Perform digital communications.
- Use visual signaling techniques.
- Survive:
 - Maintain weapons, optic, equipment, and self.
 - React to chemical or biological attack or hazard.
 - Perform immediate lifesaving measures.
 - Perform counter-improvised explosive device actions.
 - Maintain situational awareness.
 - Perform combatives.
- Adapt:
 - Assess and respond to threats (escalation of force using the established ROE).
 - Adapt to changing operational environments (terrain, visibility, temperature).
 - Grow professionally and personally.
- Battle drills:
 - React to contact.
 - Establish security.
 - Perform actions as a member of a mounted patrol.
 - Perform casualty evacuation (CASEVAC) and medical evacuation (MEDEVAC).

COMMAND TRAINING GUIDANCE

2-29. From the senior commander's training guidance, commander's assessment, staff research, and dialog with the subordinate unit commanders, the commander develops his guidance for the unit's training. The command training guidance typically identifies the following topics for achieving unit proficiency—

- The unit's training focus.
- The unit's capabilities and mission(s).
- The desired readiness level for the unit and subordinate units.
- The unit's time management cycle.
- Training environments for key training events.
- The unit's participation in any higher echelon training events or exercises.
- External evaluation requirements for the unit or in support of other units in the BCT.
- Other training guidance specific to achieving unit proficiency.

2-30. Units will follow the guidelines in FM 7-0 to complete their mission analysis, mission essential task selection, and development of their training courses of action. FM 7-0 provides general considerations for the unit's military decisionmaking process at battalion level, and the company and below troop leading procedures (TLP) for developing their respective UTPs.

TRAINING GOALS

2-31. Realistic training is a deliberate practice of conducting individual and collective tasks to enable tactical and technical proficiency. Realistic training develops cohesive teams of Army professionals who can improve and thrive in ambiguous, complex, and challenging situations. Training goals vary as the local training conditions vary. Commanders must design their training according to their available training environments and to specifically address their unit proficiency assessments. The goal is to create a training environment that is as realistic and demanding as possible with the resources available. The following goals are set to ensure successful training—

- Set and enforce tough but achievable standards. Tough standards generate effective training and loose standards produce weak units. The Soldiers must know when they have done well and when they need additional training and repetition to achieve mastery.

- Start early. All aspects of a training program must be thoroughly coordinated. Planners should forecast and request resources and maintenance assistance as early as possible.
- Be thorough. Planners should leave nothing to chance, avoid wasting resources and training opportunities, and give platoon leaders the guidance and assets needed to train their units effectively and efficiently.
- Be flexible. Planners should continually update the training program to the changing needs of the unit. If assessment and planning stop, the training program stagnates.
- Train continually. Units should train at every opportunity, not just during an intensified period. Training densities in the unit training programs bring units' proficiency to desired levels and, once completed, the units train continually to sustain that level of proficiency.

2-32. The characteristics of quality training become evident once training is planned, prepared for, and executed. The following characteristics of realistic, quality training from FM 7-0 highlight some characteristics that the units must strive to develop in their UTP and achieve during execution—

- All leaders are present and engaged.
- Unit effectively leverages training resources.
- Leader development is a priority.
- Senior leaders protect training from distracters.
- Units and Soldiers train with enablers they will operate with during future operations.
- Training environment replicates an operational environment.
- After action reviews (AARs) are integral to all training.
- Training challenges units and Soldiers intellectually and physically.
- Training is performance-oriented.
- Training is tailored to drive initiative and adaptability.
- Training provides continually changing conditions.
- Leaders train one level down.
- Units are evaluated from two levels higher.
- Units and Soldiers train repetitively.

2-33. Contingency plans and alternate methods of training should be identified when the primary plan cannot be executed. Training time is valuable and should not be lost due to unforeseen factors, whenever possible. Units should consider planning for increased fire danger hazards, firing hour constraints, environmental factors, digging requirements and restrictions, and other impacts to their plans.

TRAINING HORIZON

2-34. The training horizon is used to synchronize dedicated training time for organizations and units to train on mission-essential task list tasks. The training horizon covers the period leading up to at least one readiness aim point or may cover the entire SRM. Command training guidance is published to provide trainers with detailed information on the unit's training objective.

2-35. The following sections provide a general breakdown of major "T-increment" activities to use as a guide. It follows the T-increment concept structure found in unit training management, located on the Army Training Network website. The structure will assist in the development of the units' live-fire density. This list is not all-inclusive. Units must consider installation requirements, Army command directives, and guidance from their higher headquarters when planning training.

2-36. During the planning process for any training event, units conduct a series of tasks to ensure the unit's success. Units and MMTs should review the listed items weekly and report the status during any in-progress reviews (IPR) scheduled by the unit. For maneuver unit training, common items to monitor are—

- Individual weapons training and qualification status.
- Unit drivers training program.
- Ammunition handler certification status.
- Combat lifesaver (CLS) certification status.

- RSO and range OIC training and certification status.
- Simulations use and progression.
- Prerequisite table status.
- Current evaluators trained and certified in the unit.
- Simulations instructor/operator training and certification in the unit.
- Class V forecasting, including training ammunition, pyrotechnics, battle effects simulator (known as BES) smoke, and other enablers.

2-37. The initial planning for the training events is the most critical. Tables 2-1 through 2-15 on pages 2-11 through 2-25 show the key planning considerations and execution requirements before a unit's live-fire. The list is not all-inclusive, and units should reference their installation's policies and procedures for scheduling or securing training resources—this is only a guide.

2-38. These tables provide a general overview of key planning and preparation functions at the unit level. They are tailored to and are focused on maneuver unit training. The tables follow the operations process and integrate the eight-step training model. Each event's training timeline is a backwards planning model based on the training event's start day, termed "T-execution" or "T-X." The training density may include multiple progressive training events and may continue for several consecutive weeks based on the tasks being trained.

T-21 THROUGH T-13 – IDENTIFY REQUIRED TRAINING FACILITIES

2-39. Table 2-1 shows some key unit and MMT tasks and functions during the T-21 through T-13 period. For the National Guard, these tasks typically are completed during T-12. This timeframe focuses on identifying the major training facilities, ranges, training areas, and ammunition resources required to execute training. These resources require the longest lead-time to secure for training.

CAUTION

Training timelines are described as time remaining prior to the event execution by component.

Active Army unit training timelines = T-weeks.

Reserves unit training timelines = T-months.

Table 2-1. T-21 through T-13 Planning considerations

| <i>T-21 through T-13</i> | |
|---|---|
| <i>Identify Major Training Facilities</i> | |
| <i>Unit Tasks</i> | <i>Marksmanship Master Trainer Tasks</i> |
| Analyze prior training results. | Request land, ranges, billeting / bivouac areas for training in RFMSS. |
| Issue command training guidance. | Forecast ammunition including hostile fire simulators, smoke, and star clusters in TAMIS. |
| Identify required certifications, schooling, and professional development requirements. | Conduct instructor/operator training, as required. |
| Review and update manning roster(s). | Identify TADSS resources required. |
| Develop tentative training timeline. | Coordinate and execute range safety officer / officer in charge classes through range operations. |
| Review the driver's training program to schedule licensing and driver permits, as necessary. | |
| Legend: RFMSS – range facility management support system, TADSS – training aids, devices, simulators, and simulations, TAMIS – training ammunition management information system | |

2-40. Analyze prior training results. Units must manage their individual weapon qualification requirements to support the future training gates. Units must manage their individual, crew-served, and special purpose weapons training monthly to ensure Soldiers are qualified to participate in collective live-fire training events, as required.

2-41. Issue training guidance. The commander provides their training guidance to the subordinate units, including the appropriate training focus, mission essential tasks, and critical tasks to support building the unit's readiness.

2-42. Identify required professional development and certifications required. Units should identify all the individual and leader required certifications, qualifications, schools, classes, programs, and licenses that support the future training events. Drivers training, ammunition handlers, certified instructor/operators, range safety, and TADSS installation / troubleshooting are just a few of the most common training and certifications that need to be planned for before training execution week.

2-43. Review and update manning rosters. Units must take appropriate time to determine the formation compositions, key leader assignments, and manning status by assigned position early in the planning cycle. This will reduce the amount of refires, ammunition expenditures, or other resources to ensure an effective and efficient training program.

2-44. Develop tentative training timeline. Developing the tentative training timeline provides backwards planning during the execution weeks of the training event. Units will be able to deconflict training issues earlier, and ultimately secure the facilities, training areas, and ranges required at the earliest opportunity.

2-45. Request land, ranges, and billeting / bivouac areas. During T-21 through T-13, units identify the major training facilities required to execute their training plans. Units must follow local SOPs to secure facilities, which may not follow this timeline.

2-46. Forecast training ammunition. Munitions forecasting conducted according to AR 5-13. For example, units must consider the fire hazards during the training event and coordinate for ball only small arms ammunition availability. The unit must coordinate closely with the installation ammunition office (or similar agency) for sufficient "instead of" quantities, proper ammunition draw procedures, and how to secure any non-resourced ammunition requirements.

Note. Active Army units that fail to properly forecast training munitions at T-13 (91 days prior to training execution) are in jeopardy of not having the desired resources on hand during the training event. To ensure the training munitions are available at the unit level for the training, the unit must complete their training forecast no later than 90-days from execution.

2-47. Identify TADSS needed for event. Each category includes one or more training events that require TADSS. The unit must schedule these items well in advance based on the installation’s policies. This equipment is provided in finite quantities on the installation. Coordination of accurate training sets required allows the installation’s training support center to order, receive, process, and issue additional equipment based on the unit’s requirements.

T-12 – CONDUCT MISSION ANALYSIS

2-48. The focus of T-12 is for units to conduct a training event mission analysis and apply the military decisionmaking process and TLP. Gathering the information required to conduct training event planning is critical in developing successful training events. Units capture historical training records, AARs, maintenance status, Soldier and leader certifications, and other key training indicators to support the analysis. Table 2-2 shows some of the key unit and MMT tasks that specifically support the mission analysis.

Table 2-2. T-12 Planning considerations

| T-12 | |
|--|--|
| Conduct Training Event Mission Analysis | |
| Unit Tasks | Marksmanship Master Trainer Tasks |
| Update manning roster. | Identify and recommend sergeant’s time training topics. |
| Determine sergeant’s time training focus topics. | Plan evaluator courses. |
| Conduct staff coordination for live-fire operation order annexes and enclosures. | Develop live-fire scenarios, as appropriate. |
| | Identify Table I evaluators, plan Table I testing periods. |

Note. For Reserve units, all T-21 through T-13 tasks may be executed during T-12 or earlier on the training horizon. Most Reserve units will not have enough information concerning pending missions until 12 months before execution (T-12). Reserve units may have to adjust their planning process to support their training guidance and mission.

2-49. Determine sergeant’s time training (known as STT) topics. During T-12, units consider and plan the available STT periods available. The planning should include live-fire individual, buddy team, fire team, and squad tasks.

2-50. Conduct staff coordination. The MMT assists in the development of the operation order (OPORD) with appropriate enclosures to support the complete training plan. The base OPORD for the training event is administrative, coordinating the actions necessary to manage the preparation, execution, and recovery from the training event. The OPORD should identify the individual and collective tasks to be trained and the desired level of proficiency at the completion of training. The OPORD should address the actions to be taken to retrain the tasks during the event if the desired end-state is not achieved.

2-51. Plan evaluator training. From T-12 through T-1, simulations and gaming training (echelon dependent) are conducted monthly. The MMT must monitor the unit’s progress and ensure completion of Table II. MMTs should review the certified instructor / operators of the simulations and gaming systems. Units should use certified evaluators for all Table II exercises to build evaluator experience and their AAR techniques.

2-52. Develop live-fire scenarios. Initial development of the training scenarios is completed during T-12. The MMT must refer to the installation’s range operations regulation to ensure proper lead time is provided

for scenario approval. MMTs must complete a range reconnaissance, map analysis, terrain analysis, and targetry line-of-sight, and ensure the scenario concept can be executed to standard.

2-53. Identify Table I, PMI&E evaluators. Units must identify all prerequisite training, certifications, qualifications, and requirements to support the training. This includes a detailed review that enablers use to support training. Planning must include training and testing dates for evaluators sufficiently in advance of training and testing periods for the unit.

T-11 – REFINE EVENT REQUIREMENTS

2-54. The focus of T-11 is to refine the event training requirements based on previous training results. (See table 2-3). This focus identifies the training trends and gaps of the unit's current proficiency to address them in the commander's guidance, as needed. The MMT monitors progress in simulation and gaming systems and develops the testing plans to meet the live-fire prerequisites. The unit may develop and publish warning orders (WARNORDs) to support the upcoming training event, as necessary.

Table 2-3. T-11 Planning considerations

| T-11 | |
|---|---|
| Refine Event Requirements | |
| Unit Tasks | Marksmanship Master Trainer Tasks |
| Develop training event warning order. | Develop training synchronization matrix (TSM or GUNLINE). |
| Review training scenarios. | Review DA Form 2408-4 (<i>Weapon Record Data</i>), as necessary |
| | Schedule TADSS draw. |
| | Submit training scenarios. |
| Legend: DA – Department of the Army, GUNLINE – gunnery training synchronization matrix, TADSS – training aids, devices, simulators, and simulations, TSM – training synchronization matrix | |

2-55. Develop training event WARNORD. Units must develop the initial WARNORD for subordinate units. Include as much of the training plan as possible. Units can include topics such as planning guidance for concurrent training, follow-on collective training events, and maneuver training.

2-56. Review and submit training scenarios. Units or MMT must review scenarios to ensure they support the commander's guidance and intent. Once complete, the MMT submits the scenarios to range operations and coordinates for the appropriate targetry, BES, and pyrotechnics. Units must refer to local and installation range SOPs to ensure the appropriate lead time is provided for scenario approval.

2-57. Develop training synchronization matrix. The MMT develops the training synchronization matrix (known as TSM) or gunnery training synchronization matrix (known as GUNLINE) for the training event. Typically, this is placed on a spreadsheet to show specific ranges or training areas by day, the unit executing the training, and the type of training executed. The TSM / GUNLINE allows synchronization of the unit's efforts, provides a visual representation of the overall live-fire, and supports the tasks to subordinate units and specific instructions in the OPORD.

2-58. Review armament system checks. The MMT must review all DA Form 2408-4 for accuracy and to identify any weapon or system that may reach the threshold tube-wear or barrel-life, as appropriate for the unit type.

2-59. Schedule TADSS draw and issue. The MMT develops and schedules the TADSS plan through the local training support center. The TADSS plan must include all equipment and devices to support the prerequisite and live-training, as appropriate. This may include coordination with range operations to acquire target lifting mechanisms, scaled or full-scale targetry, BES, generators to run the equipment, and a hand-held targetry controller. Some units may require dummy ammunition that is not supplied by a training support center but must be ordered through TAMIS or the ammunition supply point on the installation.

T-10 – PUBLISH WARNING ORDER AND BEGIN PRE-EXECUTION CHECKS

2-60. The focus of T-10 is to publish the training event WARNORD to allow the supporting staffs and leaders to issue initial planning guidance and tasks. The unit determines the operational environment the training should replicate for target type, range to target, scenario development, and any supporting tactical tasks. (See table 2-4).

Table 2-4. T-10 Planning considerations

| <i>T-10</i> | |
|--|---|
| <i>Publish Warning Order and Begin Pre-execution Checks</i> | |
| <i>Unit Tasks</i> | <i>Marksmanship Master Trainer Tasks</i> |
| Publish training event warning order. | TADSS training and certification. |
| | Verify class V. |
| | Verify ranges, training areas, and facilities. |
| | Confirm TSM / GUNLINE. |
| Legend: GUNLINE – gunnery training synchronization matrix, TADSS – training aids, devices, simulators, and simulations, TSM – training synchronization matrix | |

2-61. Publish WARNORD to units. The order must contain sufficient information for the supporting staff to begin preparation for the training event. This includes items such as the required classes of supply, internal training that supports the training event, and IPR schedules.

Note. If Table I is conducted in a decentralized manner, units should provide separate guidance and orders.

2-62. TADSS training and certification. Units must schedule TADSS operator, installation, troubleshooting, and alignment classes, as appropriate. This training is critical for the unit's success during force-on-force and live-training events.

2-63. Verify ammunition requirements. Units must update OPORD for class V requirements. Units must or should coordinate class V plan for each range and training event by unit.

2-64. Verify all ranges, training areas, and facilities. Verification includes any required use of wash rack facilities, weapons zeroing, and hard stand maintenance requirements. If the unit will be establishing an ammunition holding area, the unit must confirm the appropriate approved location(s) through range operations. The MMT may have to deconflict multiuse facilities, external unit requests for the same range or facility, and other issues that negatively affect the TSM or GUNLINE.

2-65. Confirm synchronization matrix. Once all tasks are verified, unit must confirm the TSM or GUNLINE and provide the updated information to the S-3 to incorporate into the live-fire OPORD, as appropriate.

T-9 – CONDUCT RESOURCE PLANNING AND SUBMIT REQUESTS

2-66. The focus of T-9 is for units to develop and plan for the appropriate resources to support the training event. This includes all classes of supply, facilities, and external support. (See table 2-5.)

Table 2-5. T-9 Planning considerations

| <i>T-9</i> | |
|---|--|
| <i>Conduct Resource Planning and Submit Initial Resource Requests</i> | |
| <i>Unit Tasks</i> | <i>Marksmanship Master Trainer Tasks</i> |
| Conduct training event in-progress review . | Confirm training aids, devices, simulators, and simulations. |
| Final scenario review. | Verify scenario approval. |
| Publish commander's intent. | Request medical support. |
| Submit convoy clearances, as necessary. | |

2-67. Conduct IPR. The unit establishes a clear series of IPRs for the training event. These begin after the WARNORD is published during T-10 at a biweekly frequency. Once the unit reaches T-6, IPRs are conducted weekly.

2-68. Conduct final scenario review. The unit reviews the final scenario developed by the MMT.

2-69. Publish commander's intent. The S-3 publishes the commander's intent for the training event. This includes the focus of the live-fire, use of digital communications, SOP and tactical SOP reviews, simulations used in support of the training event, prerequisite training and certifications, and the end state of training.

2-70. Submit convoy clearances. The battalion or brigade logistics staff officer (S-4) submits any required convoy clearance requests as appropriate for the installation. The S-4 coordinates with the unit's supporting cavalry scouts to conduct a route reconnaissance to ensure the route of march supports any tactical or administrative convoys.

2-71. Confirm TADSS requests. The MMT must finalize the TADSS plan, including draw, training, issue, and turn-in. This includes any vehicles required to support the TADSS installation and use instruction, inclement weather areas for training, and any detail support required.

2-72. Verify scenario approval. The MMT must conduct a follow-up with range operations to ensure the range scenario is approved. Once complete, any additional documents to support the scenarios should be coordinated with range operations, including targetry, thermalization of the target presentations, pyrotechnics support, and BES use.

2-73. Request medical support. The MMT must coordinate directly with the unit medical platoon to review the medical support provided on each range. This includes reviewing the status of the certified CLS in the unit, ambulance exchange points (AXP), medical evaluation procedures and equipment, strip maps, and communications requirements. The unit's medical platoon provides the CASEVAC evaluation procedures and supports the call-for MEDEVAC and call-for CASEVAC training requirements during training events, as appropriate.

T-8 – EXECUTE RECONNAISSANCE AND LOCK-IN RESOURCES

2-74. T-8 tasks focus on range, facility, and training area reconnaissance to ensure units meet the training requirements for the planned event. Units include the entire staff into the reconnaissance effort and physically walk the terrain whenever possible. Units may have to coordinate with other units occupying the ranges or training areas planned so they do not disrupt other units' training. (See table 2-6, on page 2-16.)

Table 2-6. T-8 Planning considerations

| T-8 | |
|--|---|
| Execute Reconnaissance and Lock-in Resources | |
| Unit Tasks | Marksmanship Master Trainer Tasks |
| Conduct range walk. | Certify Table I instructors and evaluators. |
| Develop Department of Defense (DD) Form 2977 (<i>Deliberate Risk Assessment Worksheet</i>). | Conduct range walk. |
| Review local standard operating procedures and regulations for additional training requirements. | Confirm external evaluation support. |
| Develop tasks to subordinate units. | Develop conduct of the range and range/training area layout diagrams. |

2-75. Conduct range walk with leadership. Units must execute range and training area reconnaissance with key leadership and staff. This includes the identification of the primary functional areas on each range. This includes identification of items such as the ammunition pad, medic location, class I areas, maintenance areas, bivouac or billeting areas, AAR facilities, and the motor pool parking layout.

2-76. Develop the DD Form 2977 (*Deliberate Risk Assessment Worksheet*). Unit should construct the DD Form 2977, which will support each portion of the training event. This includes a review of the seasonal, live-fire, inclement weather, night operations, and extended training hour hazards.

2-77. Review local SOPs and regulations. Units should review the local SOPs and regulations for any additional requirements. This includes items such as ammunition detail requirements, emergency procedures, and range operations during severe weather.

2-78. Develop tasks to subordinate units. The S-3 develops the tasks for subordinate units and specific instructions for the OPORD that covers the small arms density or live-fire events. The MMT provides any live-fire specific items for the OPORD, as needed.

2-79. Certify Table I instructors and evaluators. The MMT certifies the instructors and evaluators for the Table I period. Subordinate units should be prepared to support the Table I with their most experienced NCOs.

2-80. Conduct range walk with SMEs. The MMT executes a range walk with the unit's experienced NCOs and subordinate MMTs to troubleshoot or war-game the live-fire and tactical plans. The MMT provides any changes, updates, or modifications of the plan to the S-3, as needed. The range walk includes reviewing the concurrent training plan, zeroing, and conduct of the range.

2-81. Develop conduct of the range briefing. The MMT develops a detailed conduct of the range briefing including the general scenarios, actions of the vehicles on the range, locations of key personnel and activities (for example, medic support), and the general flow from occupation of the range through range closure. The MMT presents this briefing to all crews and leadership executing training on the range or facility.

T-7 – PUBLISH OPERATION ORDER

2-82. During T-7, units issue the OPORD for the training event to the subordinate units and external support units. (See table 2-7.) For training that requires an external evaluation, units should provide a copy to their headquarters for coordination.

Table 2-7. T-7 Planning considerations

| <i>T-7</i> | |
|---|--|
| <i>Publish Operations Order for Training Event</i> | |
| <i>Unit Tasks</i> | <i>Marksmanship Master Trainer Tasks</i> |
| Issue training event operation order. | Confirm range support packages. |
| Confirm and issue Department of Defense (DD) Form 2977 (<i>Deliberate Risk Assessment Worksheet</i>). | Develop briefing packets. |
| Verify convoy and main supply routes. | Coordinate barrier and road closures. |

2-83. Issue training event OPORD. The S-3 issues the training event OPORD. This includes all required annexes and enclosures.

2-84. Confirm DD Form 2977. The S-3 provides commanders in the unit a copy of DD Form 2977 for record. Commanders apply risk mitigation techniques and develop their daily risk assessments, as required.

2-85. Verify convoy and main supply routes. The unit S-4 confirms and verifies all convoy routes and clearances. The S-4 prepares updates for the next IPR, as needed.

2-86. Confirm range support packages. The MMT confirms all range support package products. This includes the S-4 expendable items, targetry and associated thermalization and pyrotechnics with range operations, and any external evaluator support.

2-87. Develop briefing packets. The MMT develops the briefing packets for each range or facility scheduled for use. This includes all packages for the briefing NCO, concurrent training NCO, and unit firing status tracking plans. The MMT must consider the communications flow during the conduct of the range to ensure timely updates to all briefing packets are completed.

2-88. Coordinate barrier and road closures. Most range facilities firing medium and large caliber munitions require the use of barrier gates and road closures. The MMT coordinates the barrier gate and road closure plan through range operations. The MMT provides the accurate barrier and closure locations to the barrier detail NCO tasked in the OPORD.

T-6 – LOCK-IN TRAINING AND PUBLISH TRAINING SCHEDULES

2-89. Commanders develop their training schedules during T-6 in the DTMS to support the training event's OPORD. Table 2-8, on page 2-18, shows the key tasks for both the unit and the MMT.

Table 2-8. T-6 Planning considerations

| T-6 | |
|--|--|
| Lock-in Training and Publish Training Schedules | |
| Unit Tasks | Marksmanship Master Trainer Tasks |
| Conduct training event in-progress review (IPR). | Conduct and supervise Tables I, II, and III. |
| Develop and publish training schedules. | Verify DA Form 581 (<i>Request for Issue and Turn-In of Ammunition</i>) documents. |
| Begin execution of Tables I, II, and III. | Review officer in charge and range safety officer status of unit. |
| Legend: DA – Department of the Army | |

2-90. Conduct IPR. Unit begins conducting weekly IPRs to support the training event. Units should include a member from each staff element, the MMT, and subordinate unit leadership. Any critical changes identified during the IPR are recorded and implemented with supporting fragmentary orders (FRAGORDs).

2-91. Develop and publish training schedules. Unit commanders should complete and submit all training schedules for the training period. Once approved, the commanders will input the schedules in the DTMS and publish. Commanders must include the appropriate firing uniform, including any personal protective equipment required during live-fire use.

2-92. Conduct Table I, II, and III. Units may begin executing Table II for record. Crews that have completed Tables I, II, or III before T-6 must complete the exercise again to meet the live-fire prerequisites. There are no exceptions.

2-93. Verify DA Form 581 (*Request for Issue and Turn-In of Ammunition*). The MMT verifies all DA Form 581 information supporting the ammunition draw for the live-fire density. This includes any DA Form 581 are created to support the draw “in-lieu-of” ammunition types for use during high fire hazard periods. Units should confirm their ammunition handler certifications to ensure sufficient unit coverage on all training facilities, complexes, and areas during the upcoming event.

2-94. Review OIC and RSO rosters. The MMT should review the current list of certified RSOs and OICs in the unit. Units should strive to have all staff sergeants and above certified annually through range operations. For units firing on nontenant installations, the MMT must coordinate for range safety certifications on the approved training installation.

T-5 – COMPLETE TACTICAL PLAN AND SUPPORTING PRODUCTS

2-95. If the training event includes a tactical or maneuver portion, the unit completes those plans during T-5. Units develop the evaluation packages required for any squad, crew, or collective training planned during the training event. (See table 2-9.)

Table 2-9. T-5 Planning considerations

| <i>T-5</i> | |
|--|---|
| <i>Complete Tactical Plan and Supporting Products</i> | |
| <i>Unit Tasks</i> | <i>Marksmanship Master Trainer Tasks</i> |
| Coordinate for any observer controller-trainer requirements. | Update tower, officer in charge, and range safety officer checklists and books. |
| Conduct training event in-progress review. | Verify supplies for range support. |
| Issue fragmentary order, as needed. | |

2-96. Conduct IPR. The unit continues to conduct IPRs on a weekly basis through training execution.

2-97. Coordinate for any observer controller-trainers. If any tactical training coincides with the live-fire training, complete the observer controller-trainer plan. The unit must complete the master scenario events list supporting those collective tasks, as appropriate. For externally evaluated field training exercises, the unit must coordinate through the evaluation commander's staff for the appropriate support. Units should provide the observer controller-trainer a formal block of instruction concerning their roles, responsibilities, training and evaluation outline use, and evaluation standards.

2-98. Issue FRAGORDs. Issue any necessary FRAGORDs to subordinate units.

2-99. Update range OIC, RSO, and tower checklists. The MMT updates the tower books (sometimes termed "range book"), RSO and OIC books and checklists, and crew packets, as needed. Updates to the crew packets are completed weekly as live-fire prerequisite training and certifications are completed.

2-100. Verify range support supplies. The MMT must verify all the range support items requested to support training. This includes any scheduled targetry for construction, shipment, and delivery, as well as BES and pyrotechnics delivery. The SME must confirm the scenario in the range operating system and verify the step sequences to ensure the training scenario is replicated correctly.

T-4 – CONDUCT CERTIFICATIONS AND COMPLETE PREREQUISITE TRAINING

2-101. The unit must ensure it has sufficient personnel certified to support the training event. This training takes a several weeks and is monitored from T-4 through T-1. Certain training events have specific prerequisites that must be completed before any live-fire execution. The MMT updates the commander weekly on the progress of these requirements. (See table 2-10, on page 2-20.)

Table 2-10. T-4 Planning considerations

| <i>T-4</i> | |
|--|--|
| Conduct Certifications and Complete Prerequisite Training | |
| Unit Tasks | Marksmanship Master Trainer Tasks |
| Conduct in-progress review (IPR). | Proof range scenarios. |
| Issue fragmentary order, as needed. | Adjust scenarios, as required. |
| Conduct Table III, if planned. | Draw class V, as required (Table III). |
| Train convoy operations. | Draw class IV, as required (Table III). |

2-102. Conduct IPR. Units continue to conduct IPRs weekly. Units issue FRAGORDs to support changes or modifications, as necessary.

2-103. Draw class IV and V. The MMT or support element draws class IV and V as appropriate to support Table III, if conducted separately from the live-fire training event. If the unit conducts Table III as part of the live-fire density, these items are drawn the week before the training event.

2-104. Conduct Table III. The unit may conduct Table III, Proficiency, in a decentralized manner. Table III can be conducted between T-6 and training execution, provided it is completed before any live-fire event, including any zeroing.

2-105. Train convoy operations. Units confirm their tactical SOPs and SOPs during convoy operations training. This training supports the unit's driver training program. Units may choose to conduct convoy operations rehearsals at the completion of training but it is not required.

2-106. Proof ranges. The MMT selects a proofing team. This team must include experienced gunners and vehicle commanders. The proofing team executes two primary functions—

- Provide troubleshooting support during grouping, zeroing, or confirmation at distance (live-fire).
- Conduct proofing of each scenario on each training range. This includes target visibility, thermalization, target height, software target functioning, and BES synchronization.

T-3 – CONDUCT REHEARSALS

2-107. The unit executes rehearsals of the training event including back briefs from key leaders and staff. Units should conduct a thorough rehearsal or rock drill of the entire training event to identify potential issues as early as possible and provide sufficient reaction time to correct any deficiencies or shortcomings. The MMT continues to monitor live-fire prerequisite training and testing, and brief to the commander on the current status. (See table 2-11.)

Table 2-11. T-3 Planning considerations

| T-3 | |
|---|--|
| Conduct Rehearsals | |
| Unit Tasks | Marksmanship Master Trainer Tasks |
| Conduct key leader walk-through. | Identify firefighting details, as required. |
| Conduct medical support back brief. | Identify target details, as required. |
| Confirm manning rosters and certification requirements. | Conduct range specific officer in charge and range safety officer briefings. |
| | Rehearse barrier guard and road closure plan. |

2-108. Conduct key leader walk-through. The unit should conduct a key leader walk-through as part of the weekly IPR. This walk-through or terrain walk will provide leaders an opportunity to review the training plan on each range, training area, and facility. Units should pay particular attention to the communications and digital support plan, ammunition issue and turn-in procedures, billeting or bivouac locations, and conduct of the range procedures. The medical platoon should include a back brief to the key leaders detailing all medical support provided at each training location. This includes training and real-world procedures, such as sick-call procedures, MEDEVAC and CASEVAC plans, ambulance exchange point, and other medical tasks.

2-109. Confirm rosters and certification requirements. The unit must confirm the manning rosters and that all prerequisites have been met for all firing elements. Without appropriate personnel management and certifications, the unit significantly reduces its effectiveness and qualification status, increases the resource demands, and fails to meet training readiness and proficiency goals.

2-110. Identify firefighting and target details. The MMT must identify and brief the cast of range support. This includes identification of the firefighting NCOs, targetry NCO, barrier NCO, and their supporting detail requirements. (The specific members of the details will not be identified until the firing day.) Practice target change-out and range maintenance requirements between day and night phases, as well as between firing units.

2-111. Brief range OIC / RSO. The MMT briefs the planned and potential RSOs and OICs and provides any books and checklists they will need to execute during training. This provides them sufficient time to review their duties and responsibilities, as well as understanding the complexity of the training events they are directly supporting.

2-112. Conduct barrier rehearsal. The barrier NCO and MMT must coordinate for a full rehearsal of the barrier gate and road closure plan. This rehearsal must be coordinated with range operations and must not negatively impact or interfere with units currently training. This rehearsal is critical to ensure communications connectivity can be established and maintained with all checkpoints. It provides accurate timing of the process to ensure the range is capable of receiving an opening hot time and day and night firing time. The rehearsal includes one or more iterations for the morning closure, as well as one or more for the night closure requirements.

T-2 – FINALIZE ADMINISTRATIVE SUPPORT REQUIREMENTS

2-113. Units collect all required administrative documentation for the training event during T-2. MMTs continue to monitor the progress of the live-fire prerequisite training and testing and provide updates to the commander, as needed. (See table 2-12, on page 2-22.)

Table 2-12. T-2 Planning considerations

| T-2 | |
|---|---|
| Finalize Administrative Support Requirements | |
| Unit Tasks | Marksmanship Master Trainer Tasks |
| Conduct in-progress review. | Draw and issue training aids, devices, simulators, and simulations. |
| Update DD Form 2977 (<i>Deliberate Risk Assessment Worksheet</i>), as required. | Brief external evaluators. |
| Issue fragmentary order, as required. | Finalize training packets. |
| Legend: DD – Department of Defense | |

2-114. Conduct IPR. Units provide the updated DD Form 2977 during the IPR. Any supporting FRAGORDs supporting changes or alterations to the plan are provided.

2-115. Update DD Form 2977. Units update DD Form 2977 as appropriate, based on expected weather hazards (battalion intelligence staff officer), training factors and complexity (S-3), or live-fire issues (MMT).

2-116. Draw and issue TADSS. The MMT and a supporting detail will sign for, draw, and issue the supporting TADSS, as needed. Units must keep accurate accountability of the TADSS, particularly when using one system on multiple vehicles. The MMT must take the time to provide a method of maintaining accountability of the equipment.

2-117. Brief external evaluators. The MMT conducts a briefing with the external evaluators tasked to support the live-fire training event. This meeting should include a conduct of the range briefing, AAR expectations, facility equipment that supports the AARs, current training guidelines, and an overview of the firing scenarios day and night. It is important for the MMT to record the contact information of all external evaluators, identify the day and night shift NCOICs, and provide range transportation coordination with the evaluation team.

2-118. Finalize training packets. The MMT finalizes all training packets used for the range. This includes sufficient blank documents for retraining and all live-fire prerequisite documentation, as needed.

T-1 – DRAW EQUIPMENT AND SUPPLIES

2-119. T-1 focuses on preparing the unit to enter the training period with precombat inspections, precombat checks, convoy briefings, TLP, and conducting support detail requirements. For units that are conducting Table III as part of their training event, they draw supporting TADSS and equipment from their training support center or range operations. (See table 2-13.)

Table 2-13. T-1 Planning considerations

| <i>T-1</i> | |
|---|--|
| <i>Draw Equipment and Supplies – Execute Subordinate Rehearsals and Checks</i> | |
| <i>Unit Tasks</i> | <i>Marksmanship Master Trainer Tasks</i> |
| Subordinate units conduct PCI and PCC on all firing vehicles, armament, and thermal optics. | Verify all firers have completed Tables I, II, and III (Prerequisite tables). |
| Subordinate units perform convoy operations PCC and PCI. | Draw and issue training aids, devices, simulators, and simulations, as required. |
| Issue fragmentary order, as required. | |
| Legend: PCC – precombat checks, PCI – precombat inspection | |

2-120. Conduct precombat inspections (PCI) and precombat checks (PCC). Subordinate units conduct PCI and PCC on all firing vehicles, armament, and thermal optics. Subordinate units will perform PCI and PCC for convoy operations supporting movement to the training locations. Units are expected to validate their tactical movement portion of their SOP or tactical SOP, based on their method of movement to the training location.

2-121. Verify live-fire prerequisites. The MMT assists the unit, as necessary, to achieve 100 percent successful completion of all Table I and Table II requirements for all Soldiers. Any identified shortcomings require notification to the commander as well as a supportable training plan before firing. If Table III was completed before T-week, the unit must ensure that all live-fire participants meet all requirements.

2-122. Draw and issue TADSS. The MMT draws any remaining TADSS required to support the training plan. Coordination for routine troubleshooting and replacement of unserviceable components should be completed with the training support center.

T-WEEK – EXECUTE TRAINING

2-123. T-week lasts for the duration of the training event. Units execute the training plan, retraining plan, and other tasks developed during the previous 21 weeks (12 months for Reserve Component). During execution, the MMT maintains the current training executed for each firer, maintains and monitors ammunition expenditures on each training facility, and provides quality assurance and quality checks on all live-fire related documentation. (See table 2-14, on page 2-24.)

Table 2-14. T-Week Planning considerations

| <i>T-week</i> | |
|--|--|
| <i>Execute Training</i> | |
| <i>Unit Tasks</i> | <i>Marksmanship Master Trainer Tasks</i> |
| Open and close ranges according to local policy. | Provide range assistance, as required. |
| Manage ammunition draw, issue, and turn-in. | Oversee range operations on all live facilities. |
| Manage and record OPTEMPO utilization. | Provide quality assurance and quality checks on live-fire training score sheets, roll-ups, and after-action reviews. |
| Provide concurrent training on all training event locations. | Collect and manage firing information, engagement scores, penalties, infractions, malfunctions, and alibi information as they occur. |
| Provide and execute retraining, as appropriate. | Provide daily updates to unit performance to the commander and key leaders. |
| Conduct mandatory classes during training downtime. | Update reporting noncommissioned officer information, as appropriate. |
| Execute digital tasks supporting live-training events. | Spot-check barrier and target details. |
| Conduct daily situation reports to higher headquarters. | Verify targets are provided and presented according to TC 25-8 to include thermalization. (Proof range targetry). |
| | Provide recommendations to increase throughput and range management. |
| | Provide recommendations to the commander on live-fire related topics. |
| Legend: OPTEMPO – operating tempo, TC – training circular | |

2-124. Use facilities effectively. Open and close ranges according to installation's range safety regulations and policies for each range, facility, and training area. The tower books provided by the MMT include all pertinent information to properly open and close the training locations.

2-125. Manage training ammunition. Manage ammunition draw, issue, utilization, and turn-in. The unit's support platoon manages the issue and turn-in of all ammunition daily. The MMT and range OIC will conduct inspections periodically throughout the training days. The OIC coordinates for gathering ammunition expenditures for day and night operations on each training location.

2-126. Manage and record operating tempo utilization. The support platoon provides the OIC daily reports on class III draw by quantity, bumper number (call sign), and type of petroleum, oil, and lubricants product.

2-127. Execute concurrent training. Provide concurrent training on all training event locations that focus specifically on the training tasks for that range or training facility. Provide and execute retraining, as appropriate.

2-128. Conduct mandatory training. Units execute classes, Soldier readiness program functions, security clearances, and other mandatory AR 350-1 and personnel functions during live-fire training downtime.

2-129. Execute digital tasks. The unit signal staff officer is the primary trainer and evaluator for all digital tasks. The unit signal staff officer reports the status of each completed vehicle by bumper number and task evaluated to the MMT and OIC.

2-130. Oversee range operations and throughput. The MMT is responsible for overseeing range operations on all live facilities. They also provide quality assurance and quality checks on live-fire training score sheets, roll ups, and AARs.

2-131. Annotate training results. The range NCO promptly disseminates the information to the reporting NCO, MMT, and range OIC. The MMT and range NCO provide updates on unit performance to the commander and key leaders.

2-132. Oversee range operations. The MMT verifies targets are provided and presented according to TC 25-8 to include thermalization and hostile fire simulators. The MMT will coordinate with the range operations personnel for any targetry deficiencies found on the range. If the MMT identifies any target that is not presented to the Army standard on the qualification range, that target presentation may not be used until it is corrected. This includes targetry that is not thermalized or that does not provide the hostile fire simulation or BES to the Army standard.

2-133. Build training density AARs. The MMT provides recommendations to increase range throughput and management. Recommendations on all live-fire-related topics are provided to the commander.

T+1 – RECOVER AND ASSESS TRAINING

2-134. T+1 provides the initial tasks of recovering from training operations (see table 2-15, on page 2-26). It represents the first steps in analyzing training records from the event to develop future training requirements. Units are required to provide their live-fire results in roll-up format, as well as Table VI, Qualification score sheets to the next higher headquarters for review and analysis.

Table 2-15. T+1 Planning considerations

| <i>T+1</i> | |
|--|---|
| <i>Recover, Conduct Live-fire AARs, and Assess Training</i> | |
| <i>Unit Tasks</i> | <i>Marksmanship Master Trainer Tasks</i> |
| Open and close ranges according to local policy. | Provide detailed analysis to the commander on the live-fire results overall. |
| Manage ammunition turn-in and reconciliation. | Analyze engagements and scenarios to identify training gaps, failures, or engagements that are too easy. |
| Manage and record OPTEMPO utilization. | Determine ammunition expended versus drawn. Develop plan for turn-in and reforecasting, as necessary. |
| Develop unit status report and the quarterly training brief training comments based on training conducted. Comments must include any training impediments caused by ranges, ammunition, or facilities. | Determine and prepare Soldier awards as appropriate. This includes any certifications, qualification ratings, and distinguished performance awards. |
| Provide and execute retraining, as appropriate. | Provide recommendations to leadership for Soldier attendance to marksmanship master trainer functional courses based on performance and potential. |
| Update manning rosters, as appropriate. | Develop and provide AAR to the external evaluation unit's leadership on their performance. |
| | Develop simulations and gaming system training plan for sustainment training. |
| | Conduct AAR to gather information about ranges, scenario, training, conduct of fire, and other live-fire topics. Apply lessons learned to next unit training plan as appropriate. |
| | Provide recommendations to the commander on live-fire related topics. |
| | Submit detailed live-fire and training roll-up and complete qualification table results to higher headquarters for consolidation and submission to Weapons and Gunnery Branch, MCOE, for data collection. |
| Legend: AAR – after action review, MCOE – Maneuver Center of Excellence, OPTEMPO – operating tempo | |

2-135. Analyze training results. The analysis of the live-fire training event is critical to the unit's success. The MMT must analyze the engagements and scenarios to identify training gaps, failure, or engagements that are too easy or too demanding.

2-136. Review training ammunition expenditures. During the analysis, the MMT must determine the ammunition expended versus drawn, develop a plan for turn-in and reforecasting the ammunition, as needed. This analysis is the first step in planning the next live-fire training event. Unit closes out any active or open DA Form 581, as required. Units must reconcile all ammunition expenditures and ensure all remaining live ammunition and dunnage are turned in according to regulation and unit or installation policy.

2-137. Identify individual, crew, and small unit excellence. The analysis identifies excellence in the unit. The MMT assists the unit leadership with determining and preparing awards for certifications, qualifications, or exceptional performance, as appropriate. Soldiers identified as exceptional performers through the analysis can be recommended by leadership for attendance at MMT functional courses.

2-138. Update manning rosters. The unit must update manning rosters, as appropriate. The MMT assists in preparation of unit status reports regarding weapons and weapon systems qualifications.

2-139. Plan for sustaining proficiency. The MMT develops simulations and a gaming system training plan for qualified (experienced) elements for sustainment training. These units continue training using simulations or gaming systems to achieve the next higher level of proficiency in the system's instructional database or unit developed training scenarios, respectively.

2-140. Execute quality AARs. The unit should conduct an AAR with firing units to gather information about ranges, scenarios, preparatory training, conduct of fire, and other live-fire topics. Apply lessons learned to the next training event planning process.

2-141. Live-fire roll-up. The MMT submits a detailed live-fire and training event roll-up and complete qualification table results to the higher headquarters.

This page intentionally left blank.

Chapter 3

Range Requirements

This chapter discusses the various Army ranges that accommodate individual weapons training, the specific small arms range requirements, and required capabilities used to develop effective training events for individual weapons training, qualification, and sustainment. It includes detailed discussion on creating and proofing engagements for small arms training on the various range facilities. It details all additional requirements associated with individual weapons training, qualification, and associated advanced skill certifications used on the Army's family of small arms range facilities.

DETERMINE RANGE FACILITY

3-1. The training strategy for each individual weapon provides the primary and alternate range facilities, and identifies each target type, range band, and presentation information for all live-fire events. Units must identify the appropriate range or facility that supports the training event for the individual weapon. Units must have a working understanding of the capabilities available on the Army's standard range facilities to develop the specific individual weapons skills and capabilities to build Soldier proficiency and lethality.

3-2. Units must consider several factors to determine the training location for tactical and live-fire training events. Trainers and planners can refine the following questions to identify the scope of the training event and identify the best facility to meet the training requirements. Once complete, the unit must conduct a range reconnaissance before developing the scenario to ensure the facility meets the intent of training:

- What weapon systems will be fired and what are the ammunition requirements?
- Are thermal, illuminator, or pointers included in the training event?
- What type of target thermalization is available on the range?
- What battle effects are required during training?
- What tables or events will be fired?
- What is the desired throughput of the range for one training day?
- How many lanes will be firing?
- What are the weapon systems capabilities, limitations, and restrictions?
- What is the maximum engagement distance?
- Does the location of moving targets or custom targets influence the order of tasks to be fired?
- What targets are common to all fired weapons? What targets can be defeated by all ammunition types and weapons used during the scenarios to maximize the target presentations?
- What types of AAR capabilities are available on the range?

3-3. The family of Army ranges provides the training venue for all individual weapons live-fire training. Each range provides various capabilities based on the training focus of the facility. Planners and trainers must be familiar with the composition of each range type, their capabilities, intended use, and the range operations control area facilities associated with each. TC 25-8 provides detailed information on the Army's family of ranges and their capabilities.

3-4. Installation facilities vary and the ranges may be named differently than the range types discussed here. Facilities with specific honorary names are identified by a range type. Installations have a variety of supporting range facilities for small arms training, qualification, or certification but not all installations have all types of facilities or may not have the desired facility type available. Planners and trainers must be familiar with range facility complexes on their supporting installations, availability, accessibility, and capability.

Planners and trainers should plan to use alternate facilities as required to reach their training goals and objectives.

3-5. Primary range facilities are designed specifically to meet primary training requirements. Alternate range facilities allow units to train alternate tasks, although they may not be specifically designed to do so. Some alternate facilities may require modification to conduct the training and will require support from range operations with additional targetry, scenario development and safety plans, or additional equipment.

3-6. Table 3-1 shows the primary and alternate range facilities for each individual weapons type and the training strategy through weapons qualification. Although the primary and alternate facilities are capable of supporting the training events, the trainer must review the supporting installation’s facility capabilities to ensure the appropriate range is scheduled.

Table 3-1. Individual weapons training strategy primary and alternate range facilities

| <i>Individual Weapons Training through Qualification Event to Range Facility Matrix</i> | | | | | | | | | |
|---|--------------------------------|------------|------------|-------------|------------|-----------|------------|-------------|------------|
| <i>Training Strategy</i> | <i>Standard Range Facility</i> | | | | | | | | |
| M4 / M16 | CPQC | ARF | SFF | Zero | HSR | KD | MRF | MPMG | QTR |
| Table IV | | A | | P | | | A | A | A |
| Table V | | P | | V | | | P | | P |
| Table VI | | P | | V | | | P | | P |
| M9 / M17 | CPQC | ARF | SFF | Zero | HSR | KD | MRF | MPMG | QTR |
| Table IV | P | | | A | | | | | P |
| Table V | P | | | V | | | | | P |
| Table VI | P | | | V | | | | | P |
| M249AR | CPQC | ARF | SFF | Zero | HSR | KD | MRF | MPMG | QTR |
| Table IV | | | | P | | | | P | P |
| Table V | | P | | | | | P | A | P |
| Table VI | | P | | | | | P | A | P |
| Sniper Weapons | CPQC | ARF | SFF | Zero | HSR | KD | MRF | MPMG | QTR |
| Table IV | | | P | | P | | | P | A |
| Table V | | | P | | P | | | P | A |
| Table VI | | | P | | P | | | P | A |

Legend: A – alternate authorized facility, ARF – automated record fire range, AR – automatic rifle, CPQC – automated combat pistol qualification course, HSR – heavy sniper range, KD – known distance range, MPMG – multipurpose machine gun range, MRF – modified record fire range, P – primary training facility, QTR – qualification training range, SFF – automated sniper field fire range, V – validation using authorized, approved method, Zero – basic 10 meter / 25 meter firing range (zero)

3-7. Table 3-2 shows the primary and alternate range facilities for certification of each individual weapons type. Since the certifications focus on advanced skills, the primary and alternate facilities may not be consistent with the Army-standard training strategy for the weapon. Although the primary and alternate

facilities are capable of supporting the training events, the trainer must review the capabilities of the facility provided by the supporting installation to ensure the appropriate range is scheduled.

Table 3-2. Individual weapons certification to range facility matrix

| <i>Individual Weapons Certification Event to Range Facility Matrix</i> | | | | | | | | | |
|--|--------------------------------|------------|------------|-------------|------------|-----------|------------|-------------|------------|
| <i>Certification</i> | <i>Standard Range Facility</i> | | | | | | | | |
| Urban Rifle Marksmanship | CPQC | ARF | SFF | Zero | HSR | KD | MRF | MPMG | QTR |
| Table IV | A | | | P | | | | | A |
| Table V | A | | | P | | | | | A |
| Table VI | A | | | P | | | | | A |
| Assisted Fire | CPQC | ARF | SFF | Zero | HSR | KD | MRF | MPMG | QTR |
| Table IV | | P | | | | | P | | P |
| Table V | | P | | | | | P | | P |
| Table VI | | P | | | | | P | | P |
| Sniper Spotter | CPQC | ARF | SFF | Zero | HSR | KD | MRF | MPMG | QTR |
| Table IV | | | P | | P | | | P | P |
| Table V | | | P | | P | | | P | P |
| Table VI | | | P | | P | | | P | P |

Legend: A – alternate authorized facility, ARF – automated record fire range, CPQC – automated combat pistol qualification course, HSR – heavy sniper range, KD – known distance range, MPMG – multipurpose machine gun range, MRF – modified record fire range, P – primary training facility, QTR – qualification training range, SFF – automated sniper field fire range, Zero – basic10 meter / 25 meter firing range (zero)

3-8. Automated combat pistol qualification course (known as CPQC). This range is designed to meet training and qualification requirements for combat pistols and revolvers. This range is used to train and test Soldiers on the skills necessary to identify, engage, and hit stationary Infantry targets, from 7 to 31 meters. It includes an 8- to 10-meter walk path. All targets are fully automated, and the event-specific target scenario is computer-driven and scored from the range operations tower.

3-9. Automated record fire range (known as ARF). This range is designed for training and qualification of the M4- and M16-series weapons. Typically, it includes 16 lanes with targets at 50-meter increments out to 300 meters. Additional accessories and instrumentation may be applied to the targets, including thermal blankets, location of miss and hit (known as LOMAH), and BES. All targets are fully automated, and the event-specific target scenario is computer-driven and scored from the range operations tower.

3-10. Automated sniper field fire (known as SFF) range. This range is designed to meet most training and qualification requirements with the sniper rifle. This range is used to train and test Soldiers on the skills necessary to detect, identify, engage, and hit stationary and moving Infantry targets in a tactical array according to applicable field manuals. All targets, except iron maidens, are fully automated, and the event-specific target scenario is computer-driven and scored from the range operations tower.

3-11. Ten meter and 25 meter firing range (known as zero). This range is designed for training shot-grouping, zeroing, validation, and short-range engagement skill exercises with rifles and machine guns. For individual weapons training, this range is predominantly used for target discrimination and close combat engagement techniques. This includes forward, lateral, and rearward move-shoot engagements, as well as transition to

secondary weapon exercises. This range is used to train individual Soldiers on the skills necessary to align the sights and practice basic marksmanship techniques against stationary targets. The range requires no automation.

3-12. Heavy sniper range (known as HSR). This range is designed to meet training and qualification requirements with the heavy sniper rifle. This range is used to train and test Soldiers on the skills necessary to detect, identify, engage, and hit stationary and moving Infantry and material targets in a tactical array according to applicable field manuals. All targets, except iron maidens, are fully automated, and the event-specific target scenario is computer-driven and scored from the range operations tower.

3-13. Known distance range (known as KD). This range is designed for training rifle marksmanship and target engagement techniques. This range is used to train Soldiers on the skills necessary to identify, calculate distance, engage, and hit stationary targets in a static array. This range requires no automation.

3-14. Modified record fire range (known as MRF). This facility is an upgrade to the ARF range, which includes additional target emplacements at 75 meters and 175 meters on each lane. Additional accessories and instrumentation may be applied to the targets, including thermal blankets, LOMAH, and BES. All targets are fully automated and the event-specific target scenario is computer-driven and scored from the range operations tower.

3-15. Multipurpose machine gun range (known as MPMG). This range is used to train and test Soldiers on the skills necessary to zero, detect, identify, engage, and defeat stationary and moving Infantry targets along with stationary Armor targets in a tactical array using the M249AR and M249L light machine guns, M240B medium machine gun, M2 / M2A1 heavy machine gun, MK19 grenade machine guns, and the series of sniper weapon systems (M110, M110E1, M2010, and M107). All targets are fully automated and the event-specific target scenario is computer-driven and scored from the control tower. The range operating system is fully capable of providing immediate performance feedback to Soldiers.

3-16. Qualification training range (known as QTR). This range complex is designed to satisfy the day or night training and qualification requirements with pistols, rifles, light-, medium-, and heavy-machine guns, and the grenade machine gun. This range complex could include an ARF, SFF, CPQC, and a MPMG integrated into a single facility footprint to centralize training and reduce land, maintenance, and unit overhead requirements. All targetry is fully automated, and the event-specific target scenario is computer-driven and scored from the range control tower. The range operating system is fully capable of providing immediate performance feedback to the Soldier.

TARGETRY, INSTRUMENTATION, AND ACCESSORIES

3-17. Individual weapons training programs require specific targets, lifting mechanisms, and capabilities. This equipment is generally termed “targetry,” and must be available on the training facility to meet the training requirements. All targets must be provided according to TC 25-8. This includes the physical dimensions of the targets, their capabilities and performance parameters, as well as the thermal signatures of those targets, for both day and night engagements.

3-18. There are several types of target mechanisms and configurations used in the individual weapons training events. Each of these target mechanisms provides a specific capability to the range facility to meet the training and qualification requirements, respectively. These target mechanism types are—

- Stationary Infantry target (known as SIT). The SIT is placed in a protective emplacement and must be reconfigurable and portable. It is controlled by the range operations center (known as ROC) or tower facility using standard range operations software. The SIT targets are typically located in “clusters” of six with one moving Infantry target (known as MIT) as described below. They can be operated as a cluster or individually based on the needs of the training scenario. This device is battery-operated and controlled by, radio frequency (RF) or wireless fidelity (known as WiFi). It is capable of lifting any E-type or F-type silhouette, as well as extended E-type silhouettes that are 50 inches tall.
- Double target arm (known as DTA). The double target arm emplacement contains one stationary Infantry target lifting mechanism with a bar attachment to lift two E-type or similar targets. The SIT is placed in a protective emplacement and must be reconfigurable / portable. It is controlled

by the ROC or tower facility using standard range operations software. They can be operated as a cluster or individually, based on the needs of the training scenario. This device is battery-operated and controlled by RF or WiFi. It is capable of lifting any two tandem E-type or F-type silhouette, as well as extended E-type silhouettes that are 50 inches tall.

- Widened stationary Infantry target (known as WSIT). The widened stationary Infantry target emplacement is designed to support two stationary Infantry target mechanisms, each capable of presenting one E-, F-, or 3-dimensional (known as 3D) type target. The two SIT mechanisms are placed in a protective emplacement and must be reconfigurable and portable. They are independently controlled by the ROC or tower facility using standard range operations software. They can be operated as a cluster or individually based on the needs of the training scenario. This device is battery operated and controlled by RF or WiFi. It is capable of lifting any E-type or F-type silhouette, as well as extended E-type silhouettes that are 50 inches tall.
- Moving Infantry target (known as MIT). The MIT is placed in a protective emplacement that may or may not be portable or reconfigurable. The MIT can operate at varying speeds from 1 to 11 miles per hour (mph) and in varying direction. They are typically positioned within a cluster with six SIT emplacements. These targets in can be operated individually or as part of a larger threat cluster or squad. The MIT can include a 15-meter or 40-meter track length, depending on the training facility. Targets can move in either direction on the track, and are controlled by the range operating software in the tower or ROC.
- Stationary Armor target (known as SAT). The SAT is placed in a protective emplacement and must be reconfigurable and portable. It is controlled by the ROC or tower facility using standard range operations software. Targets for the SAT lifting mechanisms are defined in TC 25-8 and are typically manufactured locally. This provides the training unit with a variety of unarmored, light armored, aerial, and armored threats, both in frontal and flank aspects to support the training scenario. This device is battery-operated or controlled by RF or WiFi.
- Moving Armor target (known as MAT). The MAT is placed in a protective emplacement. It is controlled by the ROC or tower facility using standard range operations software. Targets for the MAT lifting mechanisms are defined in TC 25-8, and are typically manufactured locally. This provides the training unit with a variety of unarmored, light armored, aerial, and armored threats in flank aspects to support the training scenario. This device is battery operated or controlled by RF or WiFi. The MAT can operate at varying speeds from 1 to 18 mph in varying directions. It may perform as an evasive target where it may change speed and direction based on the scenario. The standard track length for the MAT is 350 meters to provide a full 50-second exposure during presentation and travel at maximum speed to the firer.
- Trackless moving target, Infantry (known as TMT-I). The TMT-I is a portable, autonomous system that is controlled by the tower software. It relies on global positioning system (GPS) mapping of the training facility to execute training tasks as an opposing force. The TMT-I can operate at varying speeds from 1 to 11 mph and must be able to traverse up to a 5 degree slope. The TMT-I is independent of any emplacement and is designed with ballistic protection up to .300 win mag. This device supports standard Infantry mechanisms, human type targets, and KD lifting mechanisms. It can support standard equipment, such as LOMAH, BES, hostile fire simulators (known as HFS), and sound effects simulators (known as SES). Targets can move along a predetermined path, move to a series of GPS positions, and react to contact in a tactical and unpredictable manner. The targets are controlled by the range operating software in the tower or ROC individually or as a series of targets to provide high value target discrimination training, based on the scenario.
- Trackless moving target, vehicle (known as TMT-V). The TMT-V is a portable, autonomous system that is controlled by the tower software. It relies on GPS mapping of the training facility to execute training tasks as an opposing force. The TMT-V can operate at varying speeds from 1 to 28 mph and must be able to traverse a 5 degree slope and varying terrain conditions. The TMT-V is independent of any emplacement and is designed with ballistic protection up to .300 win mag. This device supports 3D targets with the ability to identify specific hit areas (engine, driver, and gunner) on the vehicle, simulate the power-train failure after sufficient ballistic strikes, as well as nonlethal strikes. These mechanisms include the ability to support a minimum of two SIT mechanisms to replicate the personnel in the vehicle. It can support up to four power and interface

connections for standard target equipment, such as LOMAH, BES, HFS, and SES. The TMT-V can move along a predetermined path, a memorized path, move to a series of GPS positions, and has the ability to react to contact in a tactical and unpredictable manner. The targets are controlled by the range operating software in the tower or ROC, individually or as a series of targets, to provide scenario-based high-value target discrimination training.

- KD lifting mechanism. This target supports the lifting capability for a standard 72 inch by 72 inch KD paper target (K-type target). It has the ability to support personnel at the target location to apply hit markers. KD targets must have the ability to integrate LOMAH systems to provide real-time feedback to the shooter and trainer stations.
- Iron maiden target (known as I-type). The I-type target is a portable system made from body armor steel that provides an individual combatant threat silhouette. The silhouette provides downrange feedback when struck in a spinning or rotating fashion. The force of the firing projectile (up to .300 win mag) provides the energy required to rotate or spin the silhouette. The I-type will provide a separate lethal zone downrange feedback area on the silhouette to provide additional training capabilities. The I-type portable target must require no more than a two-man lift to emplace and recover. This target is not capable of any electronic or software control and has no power requirement. Thermal signatures are provided only through no-power thermal paper or similar equipment.

3-19. Most target mechanisms can support multiple instrumentation or accessories (termed instrumentation). This instrumentation provides training capabilities to the range facility to meet the specific training requirements for individual weapons. The Army-standard emplacement for the SIT, SAT, MIT, and MAT listed above include integration for various accessories when the emplacement is constructed with the range. When the targetry is portable or autonomous, accessories must be provided either as a stand-alone portable device or with the ability to piggy-back off of the target equipment.

3-20. The following is a list of target instrumentation or accessories required for individual weapons training, qualification, or certifications—

- Battle effects simulator. These devices provide the firer an indication that the threat is present and has fired an armor-defeating munition. This device can be programmed to execute independently or timed based on actions from a target mechanism or other instrumentation.
- Sound effects simulator. These devices provide prerecorded audio that specifically support the scenario. The SES maintains a catalog of at least 50 on-demand audio recordings. These recordings can be played on demand from the range operating software, programmed situation instances, or timed scenario events.
- Hostile fire simulator. These devices provide a simulated small arms fire cues to the shooter. They can be controlled for execution from the range operating system at varying instances for single or multiple rates of fire as the scenario requires.
- Location of miss and hit (LOMAH). This system can be applied to any target lifting mechanism to identify the relative location of direct fire impact on a target or the surrounding area. The system is capable of identifying small arms projectiles that pass through or within 72 inches of a target. The system is accurate to within 5 millimeters of the actual location (tolerance) for projectiles travelling supersonic. The system cannot identify subsonic ballistic strikes. The x and y location of all projectiles passing the z axis of the target will be provided to the range operating software and subsequently to a display for the specific shooter / trainer / spotter. The ballistic strike information must transmit via wireless means as the primary method and hardwire / fiber optic means for redundancy for fixed emplacements.
- Hit sensors. Each target must be able to register ballistic strikes by the appropriate caliber. These sensors must be placed on the target and tied to the target lifting mechanism for evaluation and scoring purposes. Each lifting mechanism must have the ability to select the number of ballistic strikes in the event the scenario requires multiple strikes to defeat the threat or if the threat requires ballistic strikes in a lethal area.
- Thermalization. Targets must be thermal capable to facilitate training using day, infrared, and thermal optics. Thermalization must follow the shapes and outlines described in TC 25-8 for the respective target silhouette.

3-21. Each facility provides a specific amount of training equipment and capability to support unit training. Units must be familiar with each range’s composition and layout to ensure the proper facility is allocated for the training event(s) planned. Table 3-3 shows each range’s Army-standard capabilities and available targetry specific to individual weapons training. This table does not include any associated training area (land) that is required to support collective training.

Table 3-3. Individual weapon range facility targetry capabilities matrix

| <i>Facility</i> | <i>Lanes</i> | <i>SIT</i> | <i>DTA</i> | <i>WSIT</i> | <i>IM</i> | <i>MIT</i> | <i>SAT</i> | <i>MAT</i> | <i>TMT I</i> | <i>TMT V</i> |
|---|--------------|------------|------------|-------------|-----------|------------|------------|------------|--------------|--------------|
| Automated combat pistol qualification course (CPQC) | 15 | 8 | | | | | | | | |
| Automated record fire (ARF) | 16 | 7 | | | | | | | | |
| Automated sniper field fire (SFF) | 4 | | | | 5 | 6 (ALT) | | | 6 (PRI) | |
| Basic 10m / 25m firing range (zero) | 32 | | | | | | | | | |
| Heavy sniper range (HSR) | 1 | 3 | | | 10 | | | 2 (ALT) | | 2 (PRI) |
| Known distance (KD) | 32 | 32* | | | | | | | | |
| Modified record fire (MRF) | 16 | 9 | | | | | | | | |
| Multipurpose machine gun (MPMG) | 10 | | | | | | | | | |
| Wing lanes | 6 | 3 | 4 | 1 | | | | | | |
| Center lanes | 4 | 4 | 1 | 4 | 5 | 6 (ALT) | 5 | | 6 (PRI) | |
| Qualification training Range (QTR) wing | | | | | | | | | | |
| Wing lanes | 6 | 3 | 4 | 1 | | | | | | |
| Center lanes | 4 | 4 | 1 | 4 | 5 | 3 (ALT) | 5 | | 3 (PRI) | |
| Basic Rifle lanes | 16 | 7 | | | | | | | | |
| Pistol lanes | 15 | 8 | | | | | | | | |

Legend: * - scissor target lifting mechanisms on known distance ranges, ALT - alternate, DTA - double target arm emplacement; one SIT with two each E-type targets, IM - iron maiden portable targets, Lanes - firing lanes available, MAT - moving Armor targets, multiple target types. Standard length 350 meter, varying speed, varying direction, m - meter, MIT - moving Infantry targets provided on the facility. D-type or E-type, 15 meter or 40 meter in length, PRI - primary, SAT - stationary Armor targets, frontal targets, locally manufactured; SIT - stationary Infantry targets. E-type or F-type per lane, TMT-V - trackless moving target-vehicle. Vehicle size programmable target, TMT-I - trackless moving target–Infantry. Individual target or target panel programmable, WSIT - widened stationary Infantry targets emplacement with two stationary Infantry targets lifting mechanisms

3-22. Lanes indicate the specific number of firing lanes for a given facility. Training planners and developers must be familiar with the number of lanes provided to ensure the firer throughput can be achieved during the training period. For multipurpose facilities like the MPMG and QTR, each capability section of the facility is listed; wing, center, basic rifle, and pistol lanes, respectively.

3-23. Facilities may contain more equipment than listed above, based on the installation's needs, adjacent or overlapping range footprints, or any facility expansion projects. The quantities listed represent the minimum requirements to meet the Army-standard facility type. Only those items specific to individual weapons training are shown for clarity.

3-24. For the purposes of individual weapons training, BESs are required on SAT, MAT, and TMT-V. Use of the BES devices require additional pyrotechnics cartridges that training units must forecast in TAMIS. Units must ensure the proper pyrotechnic cartridges are ordered to ensure the training facility provides the required target indications to meet the Army standard.

3-25. On all individual weapons ranges where SIT, DTA, WSIT, MIT, or TMT-I targetry is required, HFS must be available to support training to standard. The HFS does not require any additional pyrotechnics to support the training event. These systems typically use a light source to replicate a muzzle flash for dismounted Infantry target presentations and arrays.

3-26. Table 3-4 details the stationary types of targets typically found on individual weapons training ranges, their hostile fire indicator event, and the point of execution. See TC 25-8 for additional information concerning these instrumentation items.

Table 3-4. Stationary armored and unarmored target requirements

| Target Type | Presentation | BES or HFS Requirement | Remarks | | |
|---|---|--|-----------|-----|------------------------------------|
| | | | Cartridge | QTY | Note |
| Unarmored (SAT) | Stationary (frontal or flank) threat truck, sedan, technical truck or similar silhouette. Standard thermal, daylight, or graphic application. | Hostile fire (LA54) or ATGM missile (LA47) at 5 seconds after target lock. Steel-on-steel (LA53) within 1 second of kill standard achieved, followed by 1 each black smoke (LA71) | LA54 | 1 | Hostile fire or ATGM simulator |
| | | | LA47 | | |
| | | | LA53 | 1 | When target kill standard achieved |
| | | | LA71 | 1 | |
| Unarmored (TMT-V) | Stationary threat truck, sedan, technical truck or similar 3-dimensional silhouette. LOMAH and direct fire identification (engine block, driver, mobility kill) accessory capable. Standard thermal, daylight, or graphic application. Engine block and driver hit sensor accessories required. | HFS flash, semi-automatic or automatic fire simulated. When RPG or ATGM associated with the target, ATGM missile (LA47) at 5 seconds after initial presentation halts. Steel-on-steel (LA53) within 1 second of kill standard achieved, followed by 1 each black smoke (LA71) | LA47 | 1 | ATGM simulator |
| | | | LA53 | 1 | When target kill standard achieved |
| | | | LA71 | 1 | |
| Note: All stationary armored targets require thermalization, day and night, according to TC 25-8. | | | | | |
| Legend: ATGM - antitank guided missile, BES - battle effects simulator, HFS - hostile fire simulator, LOMAH - location of miss and hit instrumentation, QTY - quantity, RPG - rocket-propelled grenade, SAT - stationary Armor target, TC - training circular, TMT-V - trackless moving target-vehicle | | | | | |

3-27. Table 3-5 details the stationary types of targets typically found on individual weapons training ranges, their hostile fire indicator event, and the point of execution. See TC 25-8 for additional information concerning these instrumentation items:

Table 3-5. Point troop target requirements

| <i>Target Type</i> | <i>Presentation</i> | <i>BES or HFS Requirement</i> | <i>Remarks</i> |
|---|---|---|---|
| Point troop (SIT or MIT) | Stationary D-type, E-type, or H-type silhouette. Thermalized with or without garments. High value target (HVT) may be displayed as contrasting thermal or color garment. | HFS flash, semi-automatic or automatic fire simulated. | Thermalization is required day and night when thermal optics are used during the training event. |
| Point troop (TMT-I) | Stationary D-type, E-type, H-type silhouettes, or KD 72-inch frame. LOMAH and direct fire identification accessory capable. Thermalized with or without garments. HVT may be displayed as contrasting thermal or color garment. | HFS flash, semi-automatic or automatic fire simulated. May use BES (LA54) for simulated hand grenade use or ATGM missile (LA71) to simulate RPG firing. | LOMAH may be integrated into the TMT-I with certain target frames during sniper training or individual weapon certification training events. Thermalization is required day and night when thermal optics are used during the training event. |
| Iron maiden | Portable, rotating E-type with lethality zone indicators. Provides instant downrange feedback through strike rotation or action. | N/A | N/A |
| <p>Legend: ATGM – antitank guided missile, BES – battle effects simulator, HFS – hostile fire simulator, KD – known distance, LOMAH – location of miss and hit instrumentation, MIT – moving Infantry target, N/A – not applicable, RPG – rocket-propelled grenade, SIT – stationary Infantry target, TMT-I – trackless moving target–Infantry</p> | | | |

3-28. Scenarios that incorporate MATs and TMT-V add realism to the training event or exercise. Table 3-6 shows the moving target presentation capabilities, the hostile fire indicator standards, and the point of execution for the indicator. The standard track length is 350 meters but may be less depending on range terrain constraints.

Table 3-6. Moving armored and unarmored target requirements

| Target Type | Presentation | BES or HFS Requirement | Remarks | | |
|---|--|---|-----------|-----|------------------------------------|
| | | | Cartridge | QTY | Note |
| Unarmored (MAT) | Moving or evasive (flank) threat truck, sedan, technical truck or similar silhouette. Standard thermal, daylight, or graphic application. Constant or altering (evasive) speeds between 1 to 20 mph, with programmable change of direction. Engine block and driver hit sensor accessories required. | Hostile fire (LA54) or ATGM missile (LA47) at 5 seconds after target lock. Steel-on-steel (LA53) within 1 second of kill standard achieved, followed by 1 each black smoke (LA71) | LA54 | 1 | Hostile fire or ATGM simulator |
| | | | LA47 | | |
| | | | LA53 | 1 | When target kill standard achieved |
| | | | LA71 | 1 | |
| Unarmored (TMT-V) | Moving threat truck, sedan, technical truck or similar 3-dimensional silhouette. LOMAH and direct fire identification (engine block, driver, mobility kill) accessory capable. Standard thermal, daylight, or graphic application. Moving pattern controlled by preset mapping, individual control, or pre-programmed logic. Constant or varying speeds between 1 to 20 mph, with programmed, random, or artificial tactical intelligence reaction. Engine block and driver hit sensor accessories required. | HFS flash, semi-automatic or automatic fire simulated. When RPG or ATGM associated with the target, ATGM missile (LA47) at 5 seconds after initial presentation halts. Steel-on-steel (LA53) within 1 second of kill standard achieved, followed by 1 each black smoke (LA71) | LA47 | 1 | ATGM simulator |
| | | | LA53 | 1 | When target kill standard achieved |
| | | | LA71 | 1 | |
| Note: All moving armored targets require thermalization, day and night, according to TC 25-8. | | | | | |
| Legend: ATGM – antitank guided missile, BES – battle effects simulator, HFS – hostile fire simulator, LOMAH – location of miss and hit, MAT – moving Armor targets, mph – miles per hour, QTY – quantity, RPG – rocket-propelled grenade, SAT – stationary Armor target, TC – training circular, TMT-V – trackless moving target-vehicle | | | | | |

3-29. Evasive targets should have the ability to change speed and direction as well as alter their appearance or thermal signature as the vehicles' direction changes. If the scenario includes the moving target executing a short halt, an additional BES / HFS must be initiated within two seconds after coming to a halt. Table 3-7 shows the moving and evasive troop presentation requirements.

Table 3-7. Moving or evasive troop target requirements

| Target Type | Presentation | BES or HFS Requirement | Remarks |
|--|---|---|--|
| Moving or evasive troop (MIT) | Moving D-type, E-type, or H-type silhouette. Thermalized with or without garments. High value target (HVT) may be displayed as contrasting thermal or color garment. Moving targets 1 to 8 mph, constant or varying speed, single or varying direction. | HFS flash, semi-automatic or automatic fire simulated. | Thermalization is required day and night when thermal optics are used during the training event. |
| Moving or evasive troop (TMT-I) | Moving D-type, E-type, H-type silhouettes, or KD 72-inch frame. LOMAH and direct fire identification accessory capable. Thermalized with or without garments. HVT may be displayed as contrasting thermal or color garment. Moving pattern controlled by preset mapping, individual control, or preprogrammed logic. Constant or varying speeds between 1 and 12 miles per hour (mph), with programmed, random, or artificial tactical intelligence reaction. | HFS flash, semi-automatic or automatic fire simulated. May use BES (LA54) for simulated hand grenade use or ATGM missile (LA47) to simulate RPG firing. | LOMAH may be integrated into the TMT-I with certain target frames during sniper training or individual weapon certification training events. Thermalization is required day and night when thermal optics are used during the training event. |
| Legend: ATGM – antitank guided missile, BES – battle effects simulator, HFS – hostile fire simulator, KD – known distance, LOMAH – location of miss and hit instrumentation, MIT – moving Infantry target, RPG – rocket propelled grenade, SIT – stationary Infantry target, TMT-I – trackless moving target–Infantry | | | |

VISIBILITY AND EXPOSURE

3-30. Target visibility. All targets must be 90-percent visible from the firing position for the entire exposure time. For engagements that require the forward, lateral, or rearward movement of the firer, all targets must be 90-percent visible for 90-percent of the length of the movement. For example, if the target is presented for 50 seconds in the scenario, the target must be clearly 90-percent visible to the firer for a minimum of 45 seconds.

3-31. Target exposure. Target exposure is based on the firing task during the training event. Each type of event will specifically identify the amount of time the target must be exposed, as well as the time allowed for the shooter to engage and defeat the threat presented. The exposure requirements are programmed into the range operating software and are executed during the scenario automatically. Target exposure time begins when all targets for the engagement are fully presented and locked in the exposed position.

3-32. Using moving targets require scenario developers to pay particular attention to how the moving target system is used during the engagement. The following is a list of actions developers must consider when using moving targetry during scenario development:

- Determine length of track in meters. (Standard is 350 meters in length.)
- Establish a required speed of mover, direction, and evasive characteristics.
- Identify the distance to reach full speed and lock in meters. (This varies on different range facilities.)
- Determine maximum speed in kilometer per hour or mph.
- Ensure the moving target exposure time is for 16 seconds after locking and reaching set speed conditions. Ensure there is sufficient remaining track at the end of the presentation to slow and stop the moving target carriage. Typically, planners should include eight seconds for the moving

target to accelerate and raise the panel for presentation. Depending on the range operating software, this may or may not be taken into account when the scenario is generated.

- Determine the start and end point of the presentation. The scenario may require specific start locations for each lane in the scenario which may require additional time between engagements to reset.
- MITs may require direction changes to maintain movement throughout the desired exposure time for the engagement.
- When using trackless moving targets—Infantry (known as TMT-I) or trackless moving targets-vehicle (known as TMT-V) mechanisms, the developer must map out the desired actions of the moving target. This may include random or deliberate reactive tactical maneuver of the target based on a direct fire engagement from the firer. Sufficient space for the systems to function as desired after contact must be coordinated and programmed.

FRIENDLY AND NEUTRAL PRESENTATIONS

3-33. Friendly and neutral presentations may be included during select training events. These presentations provide the ability to execute target discrimination and classification as friend, foe, or neutral. Personnel (troops) or vehicle presentations may be used.

3-34. Target discrimination and classification training tasks are executed during individual weapons live-fire events during advanced skills training events included in various individual weapon certifications. Presentations during live-fire events must provide recognition of combat vehicles-compliant imagery to provide infrared and thermal signatures that most realistically replicate actual threats.

3-35. During certifications, units may be required to include operational environment elements. Training developers must consider the day, infrared, and thermal characteristics that provide the ability to discriminate the threat from friendly, neutral, or noncombatants, reinforcing the established ROE, operational environment, escalation of force, and other complex decision-making training.

SCENARIO PRESENTATIONS

3-36. Targetry may be capable of being engaged and destroyed by an individual weapon but may be subject to range limitations. The unit must consult local SOPs and installation range operations when planning scenario.

3-37. Some engagements will require the unit to select which target(s) will be presented during the scenarios. Units and trainers must ensure that the weapon and ammunition has the ability to defeat the target they select. Units can refer to figure 3-1 to determine the appropriate targetry for the weapons or systems during their training events.









| Target List | | Kill Standard by Caliber | | | | |
|--|--|--|--------|--------------|------------|----------|
| Frontal | Flank | 5.56mm | 7.62mm | .300 win mag | .338 Lapua | Cal .50* |
| Iron maiden | N/A | 1 | 1 | 1 | 1 | |
| Troop | N/A | 1 | 1 | 1 | 1 | |
|  Sedan frontal |  Sedan flank | 3 | 3 | 3 | 1 | 1 |
|  Truck, tech |  Truck, tech flank | 5 | 3 | 3 | 1 | 1 |
|  Truck, cargo |  Truck, cargo flank | 5 | 3 | 3 | 1 | 1 |
|  Bunker frontal | | This bunker is 5 foot by 10 foot and is designed for range estimation with the AN/PAS-13 thermal weapon sight. | | | | |
| <p>In troop or troop-like targets, the rounds must strike the lethal zones. To defeat vehicles, the threat must be incapacitated by striking the engine block or driver the indicated number of times. These zones are indicated by red circles for driver / passenger or the rectangle for engine block in the technical truck above.</p> <p>* Note: The M107 is a 3 MOA weapon and is intended for material defeat only. The weapon may be used against dismounted threat at ranges less than 1000 meters; however, the weapon should be restricted to material defeat tasks during training exercises.</p> | | | | | | |
| Legend: cal – caliber, mm – millimeter, MOA – minute of angle, tech – technical | | | | | | |

Figure 3-1. Troop and unarmored targetry to ammunition capabilities reference

3-38. For advanced skills events and certifications, each vehicle target may include immobilization zones capability to identify the engine compartment and driver at a minimum. These immobilization zones are required for all material defeat tasks. Table 3-8, on page 3-14, shows the immobilization hit sensor dimensions.

Table 3-8. Threat vehicle immobilization zones for advanced individual weapons training and certification

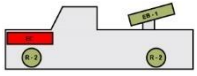
| Immobilization Zone | Length | Width | Height | Remarks |
|---|--------|-------|--------|--|
|  Engine compartment | 48" | 30" | 24" | Placed centered on the target where the engine compartment is located. |
|  Driver / passenger | 12" | 12" | 18" | Placed where the windshield, driver, or passenger windows are located on the target. For technical trucks, a silhouette representing the threat gunner may be applied using the same passenger dimensions. |
| Legend: " – inches | | | | |

3-39. For rifle and automatic rifle practice and qualification events, a barricade is required. The Army-standard barricade is constructed using three-quarter-inch plywood for the front and back and framed with 2 inch by 4 inch lumber. Figure 3-2 shows an example of the Army-standard barricade for rifle and automatic rifle live-fire events.

Note. The firing positions vary from installation to installation, based on climate, range location, and purpose. For these reasons, the construction method of the firing position itself is not provided. Installations should reference TC 25-8, for more information.

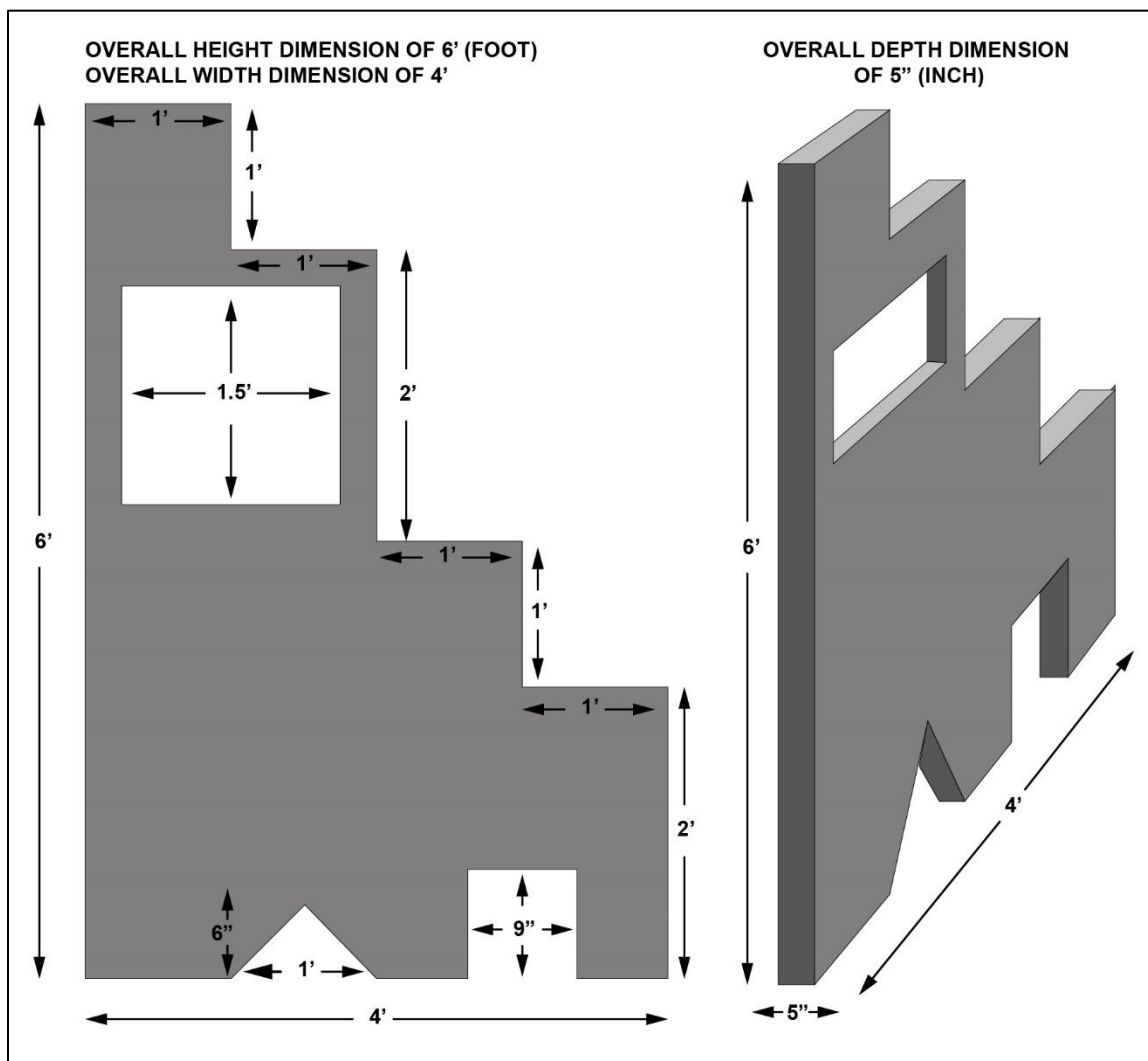

Figure 3-2. Example of the Army standard barricade for live-fire

SNIPER SPECIFIC ITEMS

3-40. For snipers, spotters, and advanced sniper team training and certification at home station, additional range requirements apply. These requirements may not be available at all installations. For installations that do not have the required items for additional advanced skills, alternate methods are used based on the installation's assets. Typically, maneuver ranges will provide sufficient alternatives to the primary training equipment, structures, or equipment.

MULTISTORY / MULTI-ENVIRONMENT FIRING PLATFORM

3-41. Certain facilities will include a multistory / multi-environment firing platform that trains, qualifies, and sustains sniper and sniper team critical skills while engaging targets from an urban structure. This facility is designed to meet the rigorous demands of the sniper and sniper team while operating in a complex urban environment. It provides 14 separate firing conditions that can be used both day and night.

3-42. The structure may be prefabricated, interlocking container style, or made from standard concrete masonry unit blocks. The structure provides the following training conditions (see figure 3-3):

- Pitched roof, reverse slope firing positions. These firing positions provide training options for the most common roof pitches in urban environments.
 - 12:12 pitch.
 - 6:12 pitch.
 - 3:12 pitch.
- Parapet. These provide firing positions from a flat roof with multiple size parapet walls. The walls will include small weep holes and optional reconfigurable firing keyholes oriented toward the target area.
 - Parapet roof, short wall, 6 inches.
 - Wall, high, 44 inches.
 - Wall, low, 11 inches.
- Reconfigurable room. These rooms contain common furniture, constructions or block materials based on the area of operations. Use of the roll up door is to provide a firing position at the furthest point from the roll up door to train light and muzzle flash discipline, keyhole firing techniques, and other skills with replaceable plywood inserts.
 - North American.
 - European.
 - African.
 - Middle Eastern.
 - Roll up door.
- Storage room, reconfigurable, single entry, no windows. This room provides training and fundamentals for closed space firing techniques.
- Room, black-out. This room allows units to train in the techniques and skills needed to fire in a completely blacked out environment.
- Room, white-out. This room allows units to train in the techniques and skills needed for effective fire engagements in extremely bright, intense light conditions.

| Multistory, Multi-environment Firing Platform | | | |
|--|---|-------------|---|
| Item | Training Feature | Item | Training Feature |
| 1 | Pitched roof, reverse slope firing position (12:12) | 8 | Pitched roof, reverse slope firing position (6:12) |
| 2 | Parapet roof firing position | 9 | Low parapet wall, 11 inches |
| 3 | Bright room | 10 | Middle Eastern designed reconfigurable room |
| 4 | North American designed reconfigurable room | 11 | Storage room, single entry, no window 6 foot x 6 foot |
| 5 | Roll up door for firing positions, reconfigurable | 12 | Pitched roof, reverse slope firing position (3:12) |
| 6 | High parapet wall, 44 inches, nonstandard | 13 | Blacked-out room |
| 7 | European designed reconfigurable room | 14 | African designed reconfigurable room |

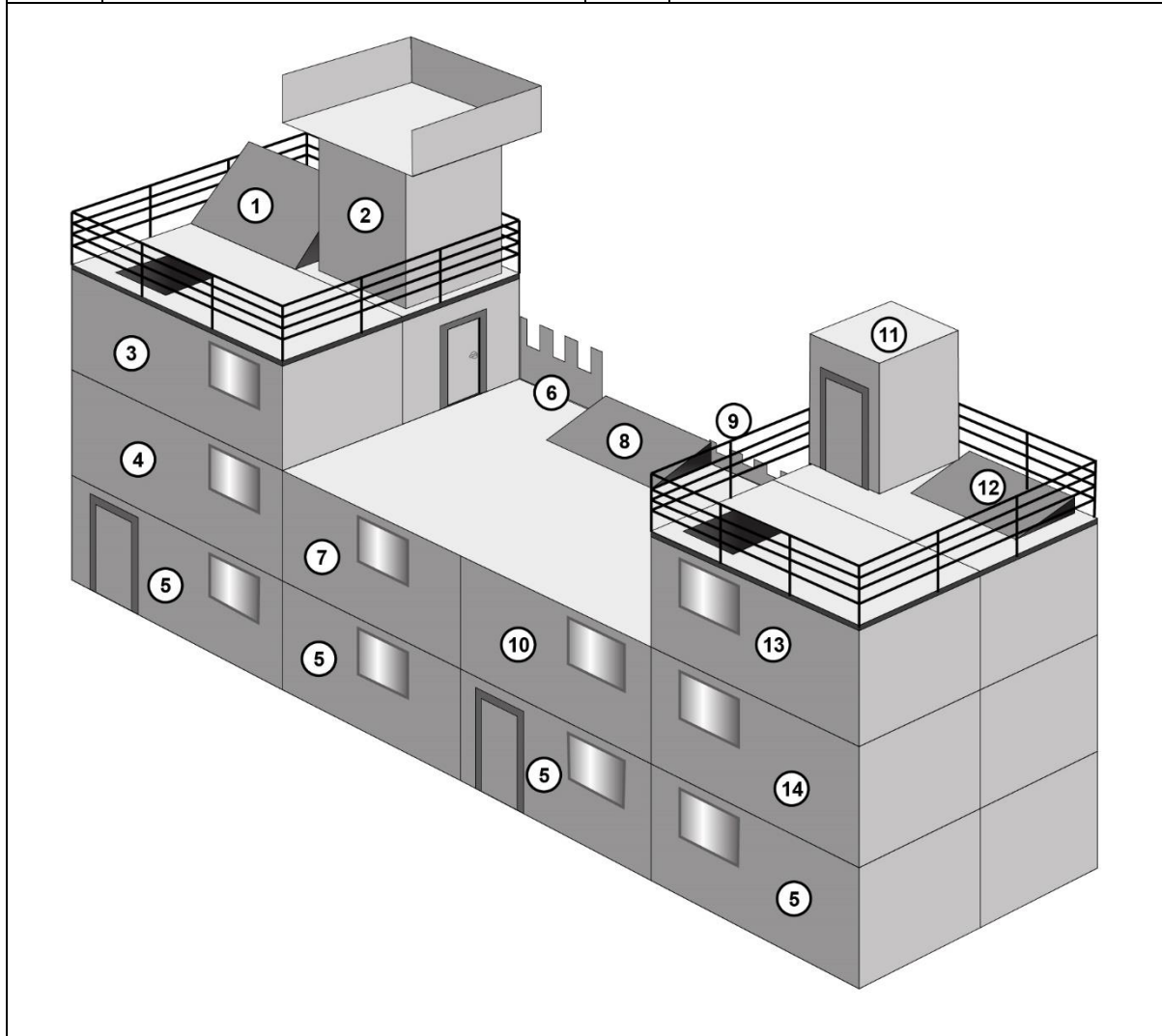

Figure 3-3. Sniper multistory, multi-environment firing platform, example

3-43. This structure is a primary structure required for sniper qualification. If it is not available, units should coordinate for use of a similar structure on a multipurpose (maneuver) range. Some firing events can be executed from elevated tower balconies or on locally manufactured room structures.

TACTICAL STALKING LANES

3-44. The tactical stalking lane is a training area that is adjacent to the firing range. The stalking lane may consist of multiple training areas or nonduded range area that permits the sniper or sniper team freedom of maneuver to a directed firing position or point.

3-45. An individual stalking lane for a single sniper is a 2,500 meters in length with varying widths to provide tactical stalking options to the sniper, sniper team, or commander, based on the scenario and OPORD. Units should plan for a 500-meter lane width to allow for lateral movement options to the training unit. Installations may make stalking routes that include changes in direction, hazards, and other obstacles.

3-46. Firing points may be included along the length of the stalking lane, although typically found only at the end of the stalking lane. Firing points along the stalking lane must be defined clearly to accurately determine authorized ammunition and targets that can be safely engaged. Units must plot surface danger zones during the training development process, as required.

3-47. Stalking lanes consist of several key components. These components facilitate all actions of the sniper, sniper team, and tower operations to effectively and safely execute the stalking exercise. These components are—

- Assembly Area. The assembly area for a stalking lane is the point where the sniper or sniper team receives their OPORD for the mission. The mission brief or OPORD must include all the way points used along the stalking lane as well as the grid location to any firing point and suspected target or engagement area.
- Start point. This is a known point in the stalking lane that initiates the timed stalking event.
- Line of departure. The line in the stalking lane is where the timed mission begins.
- Line of contact. This is an expected area where contact with a hostile force is possible. Teams are expected to move tactically from this line forward to the directed firing point(s).
- Way point or checkpoint. These are locations where the sniper or sniper team must execute a change in direction, action, or situation report. Movement between way points may be timed for evaluation purposes.
- Firing point. This is the area that allows for safe direct fire engagement of the presented target array. Each lane must have a minimum of two firing points that provide maximum engagement possibilities out to 2,000 meters.
- Rally point. This is a location identified either in the OPORD or by the sniper team leader during the mission, where the sniper team will regroup, consolidate, and reorganize, as necessary, based on the tactical situation.
- Release point. This is the point where the vehicle stops all movement and firing.

3-48. If the stalking event will include a retrograde portion with expected contact, units must coordinate for a specific range that supports fire and maneuver of the sniper or sniper team. No live fire is authorized in the stalking lane except from the identified and approved firing points.

PROOFING THE RANGE

3-49. Although small arms ranges operate using standard, preprogrammed scenarios to present the targetry, the range NCOIC still has the responsibility for “proofing” the range. Proofing of the range is the verification that each target is presented correctly to the firer, is exposed for the correct amount of time to the firer, has the appropriate sensitivity to register ballistic hits, and reacts appropriately when the appropriate kill standard is achieved. It is imperative this is conducted well before the unit arrives on the range for training. Proofing early provides the unit time and flexibility to make any adjustments to the scenario in coordination with range operations personnel, typically the target operator or range officer.

3-50. Proofing the scenario, including primary and alternate targetry, is critical for the successful execution of the unit's training event by preventing lost training time due to scenario adjustment. The unit must verify the following elements of the scenario:

- Defensive firing position line of sight is available to all targets.
- Offensive maneuver box line of sight is available to all targets presented, where required.
- Time is available to move from one firing position or posture to the next.
- Obstructions to the firer that would impede target acquisition, detection, or engagement are not present.
- Army-standard targetry, including thermalization, is provided for all engagements according to the specifications listed in TC 25-8.
- Firers can clearly see the appropriate range markers (commonly called range fans) at all firing locations, during all firing actions, day and night, for both offense and defense, as necessary.
- Unit times the sequence of events for both day and night scenarios. Night scenarios should be proofed during limited visibility.
- Unit must check the ready line area and ensure space is available for concurrent training or other training opportunities.

3-51. All conditions must be the same as if actually firing, using the same type of weapons that will be fired. If firing a multi-lane scenario, proof all lanes at the same time. Each target should be checked for validity by making sure it can be viewed through the firer's optics throughout the entire presentation time. NCOICs should use magnified optics from the firer's assigned firing position.

3-52. The range to the targets and the target presentation times should be verified for accuracy and consistency. This includes the time between target presentations. Many individual weapons training events include a specific time between presentations to reinforce reloading skills under duress.

3-53. On computer-controlled ranges, the range NCOIC will proof scenarios and coordinate to adjust target lift times, as necessary, to ensure that multiple targets are programmed to lift simultaneously. Adjustments may be necessary for delayed targets to ensure they are presented with the proper lift time and have the appropriate target exposure time.

3-54. A method the range NCOIC can use to ensure target visibility meets the Army standard is to mark each target with engineer tape or paint at the 90-percent line. For example, a standard E-type silhouette is 40 inches tall. The NCOIC can make a visible mark at 36 inches down from the top of the target. When presented, the marking at 36 inches must be clearly visible from the firer's position (see figure 3-3, on page 3-20.)

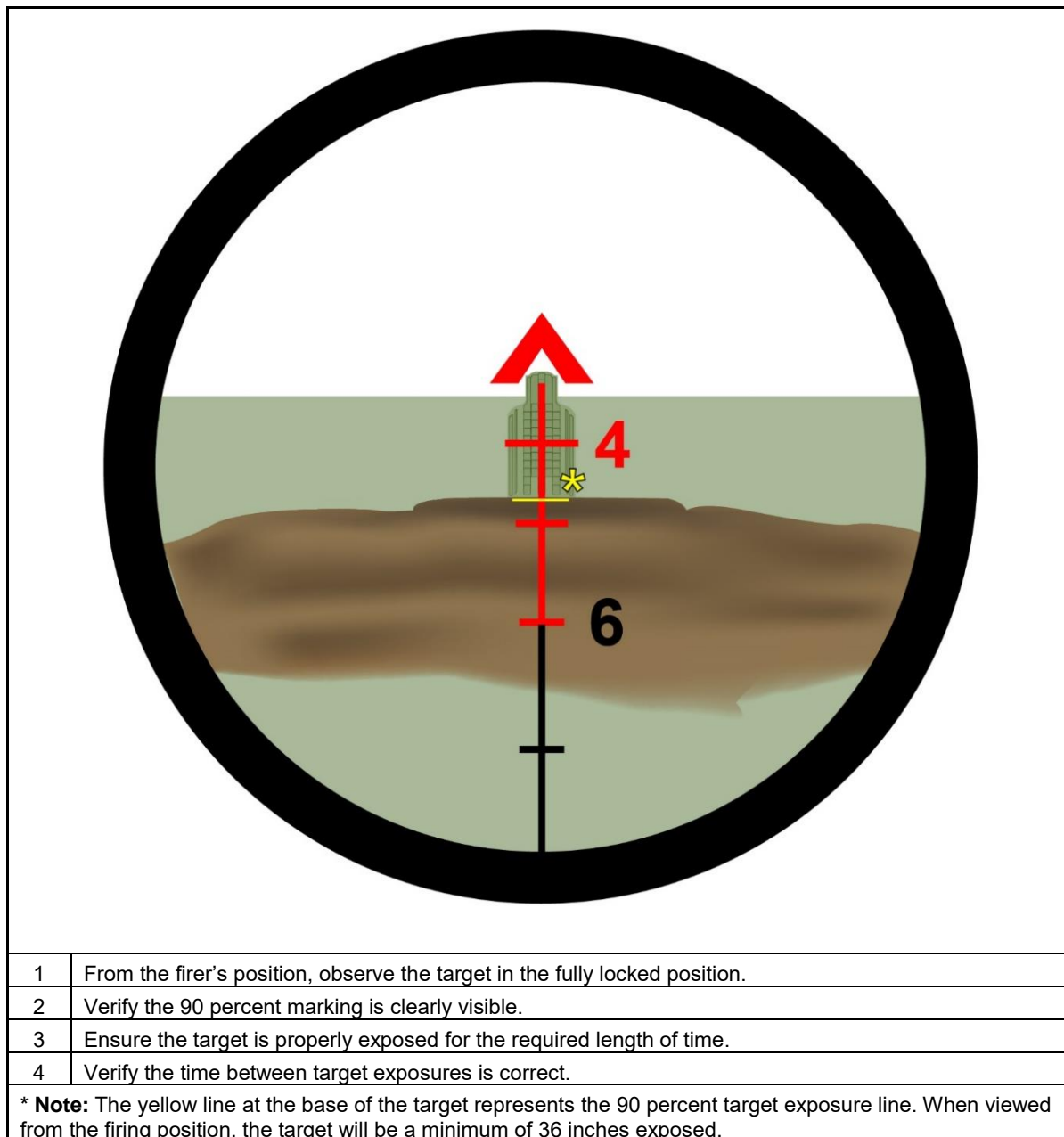

Figure 3-4. Proofing stationary Infantry target example

3-55. Use the lowest firing position available to the firer (prone) and view the targets through the entire presentation. When verifying targets, the MMT should use the thermal sight to ensure the thermalization correct for both day and night engagements.

3-56. Figure 3-4 shows a generic proofing of a SIT using a thermal weapons sight. The 90-percent line may be identified with engineer tape, or reverse polarity paper that is appropriately placed on the target. When viewing the target, the 90-percent marker should be visible to the firer.

3-57. The same process is used for stationary, moving, or evasive targets with one additional requirement. All moving and evasive targets must be visible to the 90-percent standard through 90-percent of the time exposed. With the target in motion while running the scenario, the target must meet the visibility standard for 90 percent of its exposure. See TC 25-8 for the appropriate thermal signatures. (See figure 3-5.)

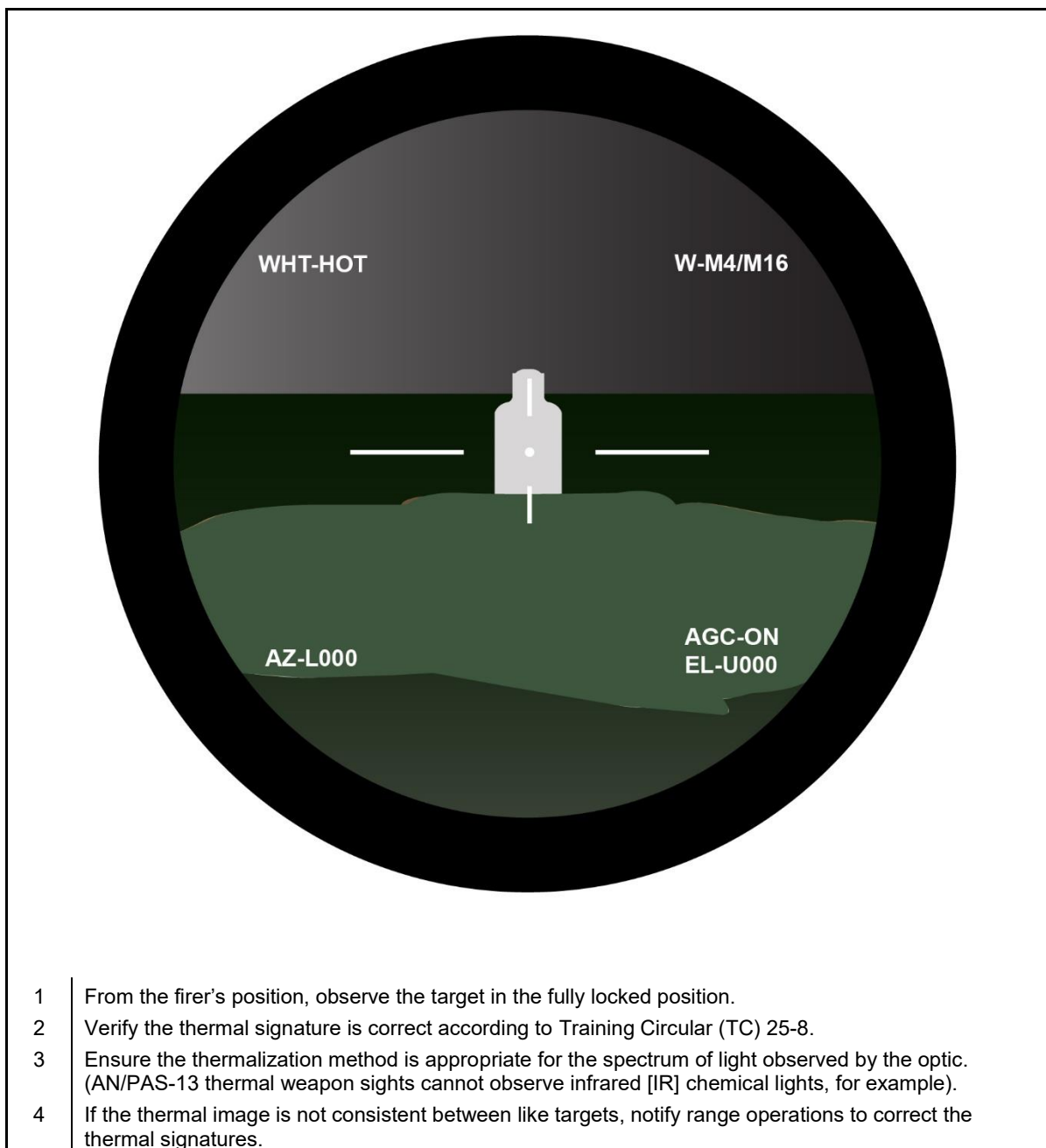

Figure 3-5. Target visibility proofing example, thermal weapon sight versus E-type target

This page intentionally left blank.

Chapter 4

Range Operations

This chapter outlines the procedures, duties, and responsibilities for planning, preparing, and executing small arms live-fire ranges for individual weapons. The individual weapon's training strategies require the use of range facilities, complexes, and training areas to efficiently reach weapon system proficiency. This chapter focuses on defining how to leverage live-fire training assets and resources appropriately to reach the intended training objectives.

The goal of this chapter is to enhance the trainers' knowledge of range operations, eliminate distractions for the training unit, and maximize the effective use of Army range facilities during the execution of live-fire training at the unit level. At a minimum, the range OIC, NCOIC, RSO, and NCO training their Soldiers should be well versed on the information provided in this chapter.

PLANNING LIVE-FIRE RANGES

4-1. The training strategy for each weapon, described earlier in this publication, provided general information used to properly plan and prepare for the training event. This section provides a more descriptive process for planning small arms ranges. The information provided is not all-inclusive but provides key topics for units to include in their detailed planning process to enable and facilitate a well-executed training event. Units should review table 4-1 and build their tentative plan, update their SOPs, and schedule for key events to support the preparation and execution of the training event (see table 4-1, on page 4-2).

Table 4-1. Small arms live-fire range planning considerations, example

| <i>Small Arms Planning Topics</i> | |
|---|---|
| <i>Topics</i> | <i>Unit Action</i> |
| Installation range operations | Receive range briefing from installation range operations. |
| Installation range standard operating procedure (SOP) | Review range or training area SOP. |
| Environmental considerations | Plan for the appropriate weather and environment impacts to training. |
| Range Scheduling | Secure range and training areas using authorized systems well in advance of the training event. |
| Army standard range facilities | Review and understand what the Army-standard facility's capabilities and limitation are. |
| Range reconnaissance | Conduct a range reconnaissance with appropriate leaders. Ensure the facility meets or exceeds the Army-standard. |
| Range or training area layout | Develop a comprehensive understanding of the range or training area layout to facilitate smooth effective use. |
| Commander responsibilities | Establish leadership interest and invest time and effort into the planning, preparation, and execution of the training event. |
| Unit small arms range SOP | Update existing unit range SOP for accuracy and effectiveness. Ensure gray areas are clarified. |

INSTALLATION RANGE OPERATIONS

4-2. The unit's supporting installation range operations provide safe, accessible, sustainable training areas and range facilities to support the mission commander's training goals and objectives. Range operations organizations vary depending on the size and capability of each range on each installation, but the organization provides the same fundamental functions in support of all training operations. During the planning process, the training planner should coordinate for an overview briefing of the range operations requirements for their installation's facilities.

4-3. The range operations branch plans, controls, and supervises weapon firing on the installation. Duties of the installation's range operations include actions to:

- Direct and enforce risk management controls pertaining to firing on ranges in coordination with the safety manager.
- Plan, schedule, and operate the installation's ranges and perform organizational maintenance.
- Plan, schedule, and supervise use of facilities, training areas (including restricted airspace), and supporting weapons.
- Develop, publish, maintain, and enforce range and training area regulations, SOPs, airspace procedures, and firing bulletins.
- Requisition, store, and issue targets, target materials, and equipment.
- Ensure that ranges are maintained and capable of meeting training needs according to the Army's integrated training area management (known as ITAM) program. The ITAM program establishes procedures to achieve optimum, sustainable use of training ranges and lands by implementing a uniform land management program.
- Ensure compliance with federal environmental laws and regulations on all range and training land assets.

4-4. The range operations officer is responsible for the coordination and safe conduct of range activity for all units using range facilities. Normally, unit leaders are required to receive a range briefing from the range

operations officer before occupying a range. Units should, if at all possible, receive the range brief prior to conducting range reconnaissance, this allows for better planning and preparation. Range operations should provide a set of local range regulations and policies.

INSTALLATION RANGE STANDARD OPERATING PROCEDURES

4-5. While at range operations, the unit must ensure they receive a current copy of the installation's range SOP. Training and firing activities require effective coordination with range operations and a thorough understanding of the installation scheduling procedures. Range operations publishes the installation range SOPs. These publications establish the policies and procedures for range activities consistent with safety and environmental regulations and Army policy.

4-6. Installations supplement the safety and environmental regulations with SOPs applicable to individual facilities in the installation-training complex. These SOPs should be reviewed for range availability and then confirmed through range operations. The range installation SOPs should, at a minimum, address the following:

- Access and egress control.
- Control and coordination of training facilities.
- Firing hours, limitation, and restrictions.
- Line of sight / safe-to-fire listing for each offensive and defensive firing area to each target location by weapon caliber for each range facility.
- AAR capabilities, thermal optics, recording capabilities, and classroom or debriefing areas.
- Environmental compliance and stewardship requirements and procedures.
- Communications between firing unit and range operations requirements.
- Accident reporting procedures.
- Ammunition and munitions handling for each training area and range facility.
- Medical support, MEDEVAC landing zone, and AXP.
- Special use airspace, restrictions, and procedures.
- Range safety requirements and procedures.
- Severe weather conditions actions and personnel safety.
- Limits of fire.
- Target availability and capability.
- Thermalization capabilities.
- Target, firefighting, and barrier detail requirements to the unit.

ENVIRONMENTAL CONSIDERATIONS

4-7. Leaders should be prepared for seasonal environmental impacts during their range time. Leaders should consider the following conditions during range planning. (See table 4-2, on page 4-4.)

Table 4-2. Environmental consideration examples

| Environment | Condition | Consideration |
|---|--|---|
| All | Day, night, limited visibility | RSO and lane safety Identification. Standard road guard vest during the day; Orange chemlight or LED flashlight at night and inclement weather. |
| <50 degrees | Snow, freezing rain, wind | Warming tent or shelter to support multiple firing orders. Coffee, tea, and soup requests to the supporting dining facility (coordinate for flatware, cups, and garbage bags through unit supply or S-4). |
| >35 degrees | Inclement weather | Dry, secure space for multiple firing orders. Coffee, tea, and soup requests to the supporting dining facility (coordinate for flatware, cups, garbage bags, and so forth through unit supply or S-4). |
| >70 degrees | Dry, no indication of rain in forecast | Be prepared for restrictions against tracer ammunition use. Coordinate with the ammunition NCO or officer at battalion or above to develop an "all ball" backup plan. |
| >70 degrees | Storm warning | Understand the actions required for thunderstorms, tornado warnings, or high wind advisories. Verify with the installation range operations office for the appropriate actions, including any river crossing, flash flood, or other critical hazards that occur frequently during the season. |
| All | All | Multiple forms of communication. Ensure tasked range personnel have a solid communications plan, to include transportation elements (bus, cargo, ammunition, and so forth), range OIC and NCOIC, RSOs, barrier guards, and range operations or firing desk. |
| Legend: < - less than, > - greater than, LED – light emitting diode, NCOIC – noncommissioned officer in charge, NCO – noncommissioned officer, OIC – officer in charge, RSO – range safety officer, S-4 – battalion or brigade logistics staff officer | | |

RANGE SCHEDULING

4-8. The RFMSS is the Army's standard, integrated system designed to efficiently schedule and manage firing ranges and training areas on active duty, National Guard, and Reserve installations. It provides the capability for authorized unit users to—

- Electronically submit requests for range, training area, and simulator reservations.
- View available facilities and schedule them for approval, disapproval, and rescheduling.
- View, identify, or detect scheduling, environmental, and safety conflicts.
- Review collected range-specific information.

4-9. Units can use RFMSS to request unit training and track the status of those requests once submitted. RFMSS supports all major range management processes. RFMSS allows training units to reserve ranges and training areas as early as 180 days in advance of the desired training start date.

- 4-10. There are two types of schedulers—the range control scheduler and the unit / customer scheduler.
- Range control scheduler. The range control scheduler is the direct interface between the range facility management and operations center and the customer or using units. The range control scheduler is responsible for—
 - Giving final approval for all training requests for range assets (tomorrow forward).
 - Scheduling training area maintenance.
 - Resolving scheduling, safety, and environmental conflicts as they arise.
 - Publishing the range bulletin.
 - Unit / customer scheduler. Unit / customer scheduler is the user of the range facilities. The unit / customer scheduler is responsible for—
 - Submitting training requests.
 - Resolving scheduling conflicts as they arise.
 - Approving requests for subordinate units if chain of command has been set up in RFMSS.
 - Issuing and approving co-use agreements.
 - Publishing the range bulletin.
- 4-11. Refer to the reference section of this publication for more information about RFMSS, or to download a digital copy of the scheduling handbook.
- 4-12. Units will use RFMSS to schedule all the range facilities, training areas, and simulation systems based on the range operations SOP. The unit should schedule and confirm their range requests typically not later than 90-days prior to the planned training. Units must refer to the installation’s range scheduling policy or range SOP for the specific procedures and lock in date requirements.

ARMY STANDARD RANGE FACILITIES

- 4-13. Army training ranges are specifically designed to train individual through combined arms collective tasks required by doctrine with range, ammunition, and explosives safety requirements in mind. These facilities offer the primary trainers and commanders live-fire ranges capable of training and qualifying Soldiers on instructional, preliminary, basic, intermediate, and advanced skills in both individual and collective training.
- 4-14. Understanding the full capabilities, structure, layout, and requirements for each range type is essential for commanders, leaders, planners, and trainers. Without this understanding, commanders, leaders, planners, and trainers will find it very difficult to efficiently and effectively plan and execute realistic training that meets their training requirements, goals, and objectives.
- 4-15. TC 25-8 provides information regarding all varieties of ranges available to the Army, target types and their ordering / construction, acceptable target heights, and information about range operations. Units must be familiar with the Army-standard facility composition, capabilities, and limitations to plan training effectively. Also, during training on an installation facility that does not meet the Army-standard as listed in TC 25-8, commanders must inform their higher headquarters of the shortcomings, deficiencies, or conditions of the facilities or training areas they’ve used. Without user reporting and command involvement concerning the state of the facilities, those facilities may not receive the corrective action or attention they require.
- 4-16. Table 4-3, on page 4-6, shows the primary range facilities for individual weapons training. Not all installation facilities provide the same capabilities to the training unit. Units must confirm the available facilities, capabilities, and limitations with their supporting installation’s range operations.

Table 4-3. Primary, alternate, and certification capable range facilities

| <i>Facility Name</i> | <i>Abbreviation</i> | <i>M9 M17 / M18</i> | <i>M4 M16</i> | <i>M249AR</i> | <i>Sniper Weapons</i> |
|---|---------------------|-------------------------|-------------------|---------------|---------------------------|
| Automated record fire range | ARF | | P | P | |
| Combat pistol qualification course | CPQC | P | C | | |
| Heavy sniper range | HSR | | | | P |
| Known distance range | KD | | | | |
| Multipurpose machine gun range | MPMG | | | | P |
| Modified record fire range | MRF | | P | P | |
| Sniper field fire range | SFF | | | | P |
| Qualification training range | QTR | P | P | P | |
| Basic 10-meter / 25-meter range (zero) | Zero | A | C | C | A |
| Note: The M249AR training strategy is designed for execution on the ARF, MRF, or QTR. Only the M249L will utilize the MPMG for live-fire training. This is to ensure the Infantry squad can train their individual weapons (rifle, carbine, and automatic rifle) on the same range facilities. | | | | | |
| Legend: A – alternate range facility, AR – automatic rifle, C – certifications completed on the facility, P – primary range facility | | | | | |

RANGE RECONNAISSANCE

4-17. The commander, S-3, or MMT, as appropriate, conduct a reconnaissance of the ranges they will use to support their individual weapons training plan. Additionally, the OIC and NCOIC for each range should personally conduct a reconnaissance and coordinate with range operations headquarters approximately eight weeks before training. The reconnaissance should provide answers to the following questions:

- What routes to the ranges or training areas will be used?
- What is the range throughput capability? These capabilities include the following considerations (see table 4-4)—
 - How many firers does the unit expect to train? (Total number of firers [F]).
 - How many lanes are available? (Number of operational lanes [L]).
 - What is the average time to conduct one complete firing order, day or night phase? (Planning factor = 15 minutes for individual weapons training events [t]).

Table 4-4. Small arms range throughput calculation example

| SMALL ARMS RANGE THROUGHPUT CAPABILITY | | | | | | | | | | | | | |
|--|--|-------|-------|-------|------|------|------|------|------|------|------|------|------|
| FIRERS | NUMBER OF FIRING LANES AVAILABLE IN FIRING ORDER | | | | | | | | | | | | |
| | 4 | 5 | 6 | 7 | 8 | 9 | 10 | 11 | 12 | 13 | 14 | 15 | 16 |
| 50 | 3:15 | 2:30 | 2:00 | 1:45 | 1:30 | 1:30 | 1:15 | 1:15 | 1:00 | 1:00 | 1:00 | 0:45 | 0:45 |
| 100 | 6:15 | 5:00 | 4:15 | 3:30 | 3:15 | 2:45 | 2:30 | 2:15 | 2:00 | 2:00 | 1:45 | 1:45 | 1:30 |
| 150 | 9:30 | 7:30 | 6:15 | 5:15 | 4:45 | 4:15 | 3:45 | 3:30 | 3:15 | 3:00 | 2:45 | 2:30 | 2:15 |
| 200 | 12:30 | 10:00 | 8:15 | 7:15 | 6:15 | 5:30 | 5:00 | 4:30 | 4:15 | 3:45 | 3:30 | 3:15 | 3:15 |
| 250 | 15:45 | 12:30 | 10:30 | 9:00 | 7:45 | 7:00 | 6:15 | 5:45 | 5:15 | 4:45 | 4:30 | 4:15 | 4:00 |
| 300 | 18:45 | 15:00 | 12:30 | 10:45 | 9:30 | 8:15 | 7:30 | 6:45 | 6:15 | 5:45 | 5:15 | 5:00 | 4:45 |
| HOURS TO COMPLETE ALL SCHEDULED FIRERS WRITTEN HOURS:MINUTES (HH:MM) | | | | | | | | | | | | | |
| <p>NOTES:</p> <p>The planning factor for time to complete one individual weapon firing order is 15 minutes.</p> <p>The following formula is used to refine the planning factor to complete a deliberate range throughput analysis.</p> <p><i>F</i> = Total number of firers <i>L</i> = Number of operational lanes <i>t</i> = Time to conduct one firing order: 1.00 = 1 hour 0.75 = 45 minutes 0.50 = 30 minutes 0.25 = 15 minutes</p> $\frac{F}{L} (t) = T_p$ <p><i>T_p</i> = Total time to complete all firing orders to proficiency.</p> <p>When the calculated time is greater than 8 hours, units may require additional support, depending on the number of refires, range firing hours, first round downrange time, and environmental conditions.</p> | | | | | | | | | | | | | |

- Are firing positions and barricades available when required?
- What control facilities are available? What is their condition? Is there a target operator or will the unit assume target operator functions? If the tower operations computer is run by the unit, what class or certification is required in advance of the training event?
- Is the tower equipped with frequency modulation (FM) communication equipment? What is the unit required to provide? What will the installation or range facility provide? What are the frequencies used for firing, range operations, and administrative or logistics?
- Are range safety markers visible for live fire? How will they be illuminated and thermalized at night, if required?
- Did range operations provide SOPs? Review the SOPs for the procedures or actions for the following:
 - How is access to the impact area controlled for live fire?
 - What are the guard and barrier requirements?
 - Does the range support firing of all types of ammunition and pyrotechnics required for the training event?
 - Who furnishes targets and target supplies? Where are targets stored?
 - Are the targets the correct type, size, shape, and color?

- What is the condition of the target mechanisms?
- What is the condition of the tower public address system?
- Who provides the target details?
- Are special purpose panels available to support borelighting, alignment, or attachment zeroing functions? Is it illuminated and thermalized?
- Can Soldiers boresight while the firers are conducting training?
- What is the condition of moving targets, as available?
- Who will furnish firefighting equipment, range flags, and range regulations?
- Who will supply thermal optics for scoring and control (range cameras and recording equipment), when appropriate?
- What pyrotechnics are required for the training scenario?
 - Does the range or facility approve their use?
 - Who emplaces the BES required on all presented targets?
- Where are the following range operations and control areas (known as ROCAs) (see figure 4-1 for an example range sketch):
 - Ammunition point?
 - Clearing barrels?
 - Barriers locations / guard posts?
 - Mess area?
 - Latrine?
 - Helipad or MEDEVAC landing zone?
 - Aid station or defined medic support location?
 - Troop break and billet or bivouac areas?
 - Weapons maintenance area? Unit armorer when required?
 - Briefing and debriefing area (AAR facility)? What are the AAR capabilities on the range?
 - Wheeled vehicle parking area?
 - Concurrent training area?
 - Water point?

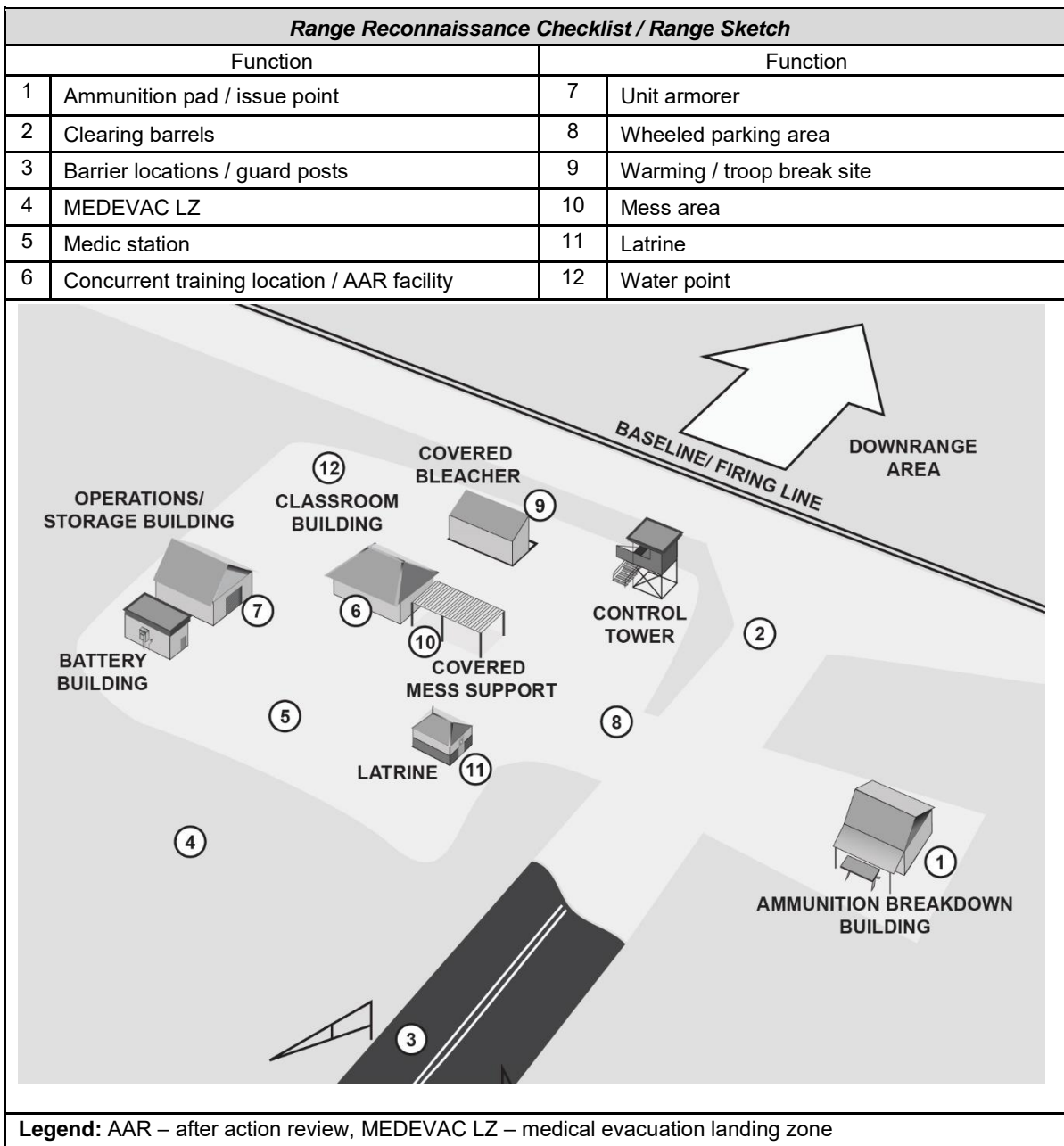

Figure 4-1. Range sketch example

- What are the expendable supplies required to support the range, such as lane marking, personal hygiene, cleaning, and so forth?
- How can the unit maximize firer throughput on the range?
- Can the unit schedule Soldier movement to the range facility to maximize their time effectively?
- How much time should be planned for retraining or refires?

COMMANDER RESPONSIBILITIES

4-18. Effective live-fire training, executed to a high standard before, during, and after execution, is the cornerstone of operational success. The training of the individual critical tasks that Soldiers must accomplish

to build and sustain proficiency is directly related to leadership involvement in all aspects of individual weapons training. Units must be able to run a variety of range and training area facilities with varying levels of support from range operations. To conduct live-fire training events efficiently and effectively, the unit leadership must be present, proactive, involved, and engaged during planning, preparation, execution, and recovery from the training event.

4-19. Battalion / squadron commanders must—

- Comply with the installation procedures for the certification of OICs and RSOs.
- Provide sufficient preparation time for junior leaders, range support, and prerequisite training.
- Conduct risk management for all range operations.
- Ensure leadership presence on the range during training.

4-20. The unit commander must—

- Ensure compliance with DA PAM 385-63, applicable technical manuals (TMs), field manuals, training circulars, installation range guidance, and applicable SOPs for safe training and firing for each weapon system in the command.
- Ensure all personnel in the command are briefed on and comply with installation range procedures and safety requirements including required personal protective equipment.
- Designate an OIC and RSO for each firing event or phase according to AR 385-63/MCO 3570.1C and DA PAM 385-63.

UNIT SMALL ARMS RANGE STANDARD OPERATING PROCEDURES

4-21. A unit range SOP (typically termed a GUNSOP or gunnery SOP) saves both time and energy for the firing unit. The GUNSOP should include guidelines for occupying the range and describe actions to be taken for specific tasks. The unit GUNSOP should integrate their supporting installation's information, Army range regulatory requirements, and local policies. Table 4-5 provides a general list of range specific topics and where the information can be obtained.

Table 4-5. Unit GUNSOP topic reference and development example

| <i>Range Item or Topic</i> | <i>Unit</i> | <i>Installation</i> | <i>Policy</i> |
|---|-------------|---------------------|---------------|
| OIC and RSO requirements and responsibilities. | X | X | X |
| Range access and egress control. | | X | |
| Firing hours, limitations, and restrictions. | | X | X |
| Accident reporting requirements. | X | X | X |
| Severe weather conditions immediate actions. | | X | |
| Range opening instructions. | | X | |
| Occupying range or training area instructions. | | X | |
| Actions after receiving a “hot” or “wet” firing status. | | X | |
| Target detail requirements. | | X | |
| Guard force requirements. | | X | X |
| Briefing NCO requirements. | X | X | |
| Communication requirements to: <ul style="list-style-type: none"> • Range operations. • Unit headquarters. • Higher headquarters. • Medical support. • Administrative and logistics. | X | X | X |
| Weapons maintenance support. | X | | |
| Firefighting detail requirements and equipment. | | X | |
| Safety briefing standards. | | X | X |
| Conduct of the range briefings. | X | | |
| Firing orders. | X | | |
| Range closing procedures and requirements. | | X | X |
| Actions for requesting “cold” or “dry” firing status. | | X | |
| Close-out report requirements. | | X | |
| Departing the range by the training audience. | X | X | |
| Closing the range facility requirements. | | X | |
| Environmental stewardship compliance and requirements. | | X | X |
| Clearing range facility ownership. | | X | |
| Legend: NCO - noncommissioned officer, OIC – officer in charge, RSO – range safety officer | | | |

RANGE SUPPORT PERSONNEL

4-22. The commander is responsible for safety during all phases of training; however, he designates key personnel to run or operate an individual weapons training event. The minimum personnel required to operate any range or training area is an OIC, RSO, and medical support appropriate to the level of the training exercise as governed by regulation, local policy, or command guidance.

4-23. Range support personnel are described in three groups: required, recommended, and as directed personnel. Table 4-6, on page 4-12, shows a general structure of common range support personnel for small arms ranges.

Table 4-6. Common range support personnel structure example

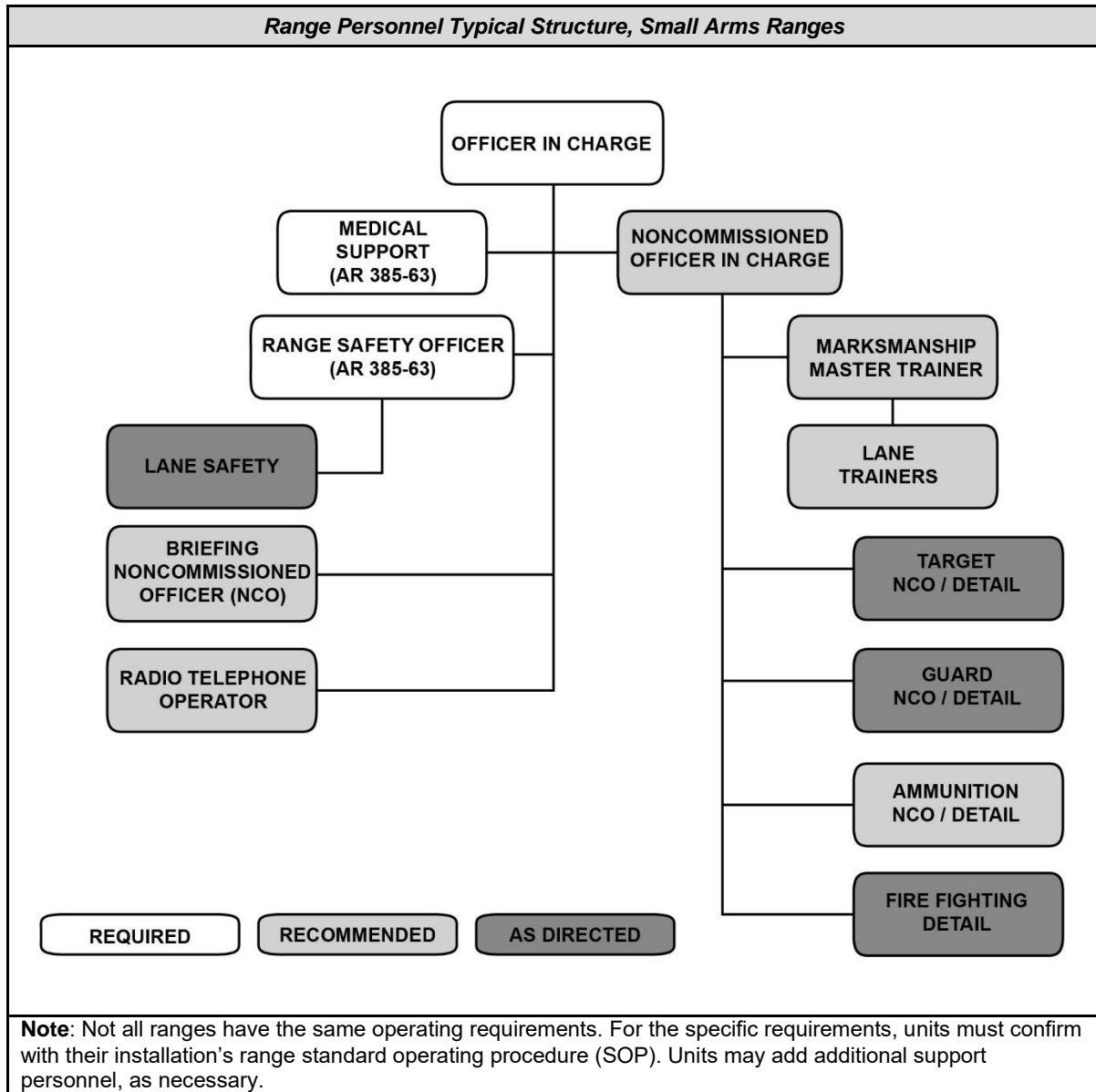

Note. Not all ranges have the same operating requirements. Units must confirm with their installation's range SOP for the specific requirements. Units may add additional support personnel, as necessary.

REQUIRED PERSONNEL

4-24. These personnel are required to maintain appropriate certifications or qualifications by Army policy or regulation. Units must maintain the required supporting training and certification documentation on the training facility prior to, during, and at the completion of the training event. The required personnel and their specific responsibilities are—

- OIC – One day, one night (see DA PAM 385-63). The OIC is responsible for everything that occurs at the training site.
- RSO – One day, one night (see DA PAM 385-63). The RSO is responsible for ensuring the safe conduct of the live fire range.
- Medical personnel – Certified with dedicated wheeled transportation and communications systems, day and night (see DA PAM 385-63 and local policy). The medical personnel provide immediate medical care based on their capabilities in direct support of the live-fire event.

RECOMMENDED PERSONNEL

4-25. The commander typically assigns other personnel to assist in running the training event, so he can supervise the overall event more effectively. Recommended additional personnel who the commander should use to maximize the quality of training, provide the best use of the range facility, and maximize training ammunition and other resources. They include:

- NCOIC – One day, one night. NCOICs directly support the range OIC in the safe, efficient, and effective conduct of the range.
- MMT – One day, one night. MMTs are the commander's direct fire technical advisor of the capabilities and limitations of all individual weapon systems, optics, thermals, pointers, illumination, and ammunition during training and tactical employment?
- Lane trainers – Quantity based on the number of firing points. Lane trainers are experienced leaders who are qualified on the weapons, systems, optics, and devices used during the training event.
- Briefing NCO – One day and night. Units may rotate several experienced NCOs. They provide detailed training information to unit leaders who are not part of the training audience or select visitors.
- Radio-telephone operators (known as RTOs) – One day, and one night. RTOs are typically junior Soldiers who have experience with RTO procedures and provide communication system operation for the range facility.
- Ammunition NCO and detail – One day and night, ammunition handler certified. Typically, they are responsible for a small ammunition detail to prepare multiple firing orders worth of preset magazines, belted ammunition, or bandoliers. Units generally use Soldiers from later firing orders to perform ammunition detail functions. The NCO oversees the ammunition detail and maintains accountability, distribution, collection, and reconciliation of the training event's munitions.

AS DIRECTED PERSONNEL

4-26. Depending on the range facility, the training event scheduled, the number of Soldiers being trained, and environmental conditions, units may be directed to support additional functions. These directed functions include a lead NCO with a supporting detail of two or more Soldiers. The most common directed personnel are—

- Lane safeties – Multiple experienced leaders, as necessary, who ensure the safe conduct of the range.
- Target NCO and detail – as directed by the installation's range SOP or policy. They provide oversight of target placement, replacement, servicing, and repairs, as needed.
- Firefighting detail – as directed by the installation's range SOP or policy. Typically, Soldiers are identified personnel in later firing orders who provide firefighting functions, as needed.
- Guard or barrier NCO and detail – These Soldiers secure the range or SDZ boundaries and entry points as required by the supporting installation.

OFFICER IN CHARGE

4-27. The OIC is the officer, warrant officer, or NCO responsible for personnel conducting firing or operations in the training complex. The range OIC has overall responsibility for the range, its conduct, and the actions of support personnel and training audience.

4-28. OICs, at a minimum, will be certified in the weapons or weapon systems for which they are responsible. They must be appointed by the battalion or squadron commander and must have successfully completed and maintained currency in the installation's range safety certification program.

Note. To be certified for individual, crew-served, and special purpose weapons, the OIC must successfully complete Table I, PMI&E, within 90-days of the training event.

4-29. The range OIC must meet the rank and experience requirements based on the type of training event planned, as outlined in DA PAM 385-63, described in table 4-7.

Table 4-7. Individual, crew-served, and special purpose weapons minimum officer in charge appointment requirements

| <i>Weapon or Weapon System</i> | <i>OIC</i> | | |
|---|------------|-----------|------------|
| | <i>OFF</i> | <i>WO</i> | <i>NCO</i> |
| Small arms, machine guns, subcaliber devices, practice hand grenades, laser devices, simulators, trip flares, chemical agents, and smoke grenades. | X | X | SSG |
| Live grenades, grenade launchers, live mines, demolitions, recoilless rifles, direct fire antitank rockets, and missiles. | X | X | SFC |
| <p>Notes. For more information concerning OIC requirements, see AR 385-63/MCO 3570.1C and DA PAM 385-63. Civilians in the grade of GS-07 or above or equivalent may act as OIC. Civilian contractors may serve as an OIC when approved by the installation commander according to the installation's policy and the contract statement of work.</p> | | | |
| <p>Legend: AR – Army Regulation, DA PAM – Department of the Army pamphlet, GS – Department of the Army general schedule employee, NCO – noncommissioned officer, OFF – officer, OIC – officer in charge, SSG – staff sergeant, SFC – sergeant first class, WO – warrant officer</p> | | | |

4-30. For weapon systems equipped or dependent on lasers, the OICs will be knowledgeable of laser hazards and proper employment. The OICs hold responsibility and accountability for the conduct of the activity and the adherence to governing regulations and guidance. They must be able to fully influence the conduct of the event.

4-31. The basic responsibilities of the OICs for small and medium caliber ranges are shown in table 4-8. This is not an all-inclusive list. Units may revise and add to this list, as needed.

Table 4-8. Range officer in charge responsibilities, example

| <i>Task</i> | <i>Before Training</i> | <i>During Training</i> | <i>After Training</i> |
|---|------------------------|------------------------|-----------------------|
| Ensure OIC certification is valid. | X | | |
| Receive a range safety briefing from installation range control organization on use of the training complex. | X | | |
| Ensure plans for firing exercises and maneuvers are coordinated with range control. | X | | |
| Ensure coordination and approval has been gained from the range control agency for all civilian personnel that will be entering the training site. | X | X | |
| Review communications plan. | X | | |
| Participate in the range walk. | X | | |
| Conduct range rehearsal. | X | | |
| Verify range equipment available. | X | | |
| Review range SOP and operating requirements. | X | | |
| Implement risk management in all phases of the training events. | X | X | X |
| Inspect and sign for range. | X | | |
| Conduct communications check. | X | X | |
| Ensure range equipment is present and operational. | X | | |
| Ensure the RSO is physically present at the training site. | X | X | X |
| Brief the RSO on the duties to be performed in support of the training event. Clearly establish the requirement for the RSO to brief the OIC on the safety of the facility and unit, and the readiness to commence live-fire operations prior to the start of firing. | X | | |
| Conduct safety specific checks with the RSO. | X | | X |
| Ensure adequate medical support is available. | X | X | X |
| Ensure control of target areas to prohibit entry by unauthorized personnel. | X | X | X |
| Prepare to open the range with all required training information (see open range). | X | | |
| Ensure the overall safe conduct of training and proper use of the installation training complex. | X | X | X |
| Make hourly communications checks with range operations. | X | X | |
| Provide range orientation briefing (see range brief). | X | | |
| Inspect ammunition issue point. | X | | |
| Ensure ammunition and explosives are properly handled, transported, stored, and accounted for within the training complex from the time of receipt to the time of expenditure or turn-in. | X | X | X |
| Report occupation; requests "hot" or "wet" firing status. | X | | |
| Determine when it is safe to fire according to applicable regulations and installation range requirements. | X | X | X |
| Ensure receipt of final clearance to fire from range control. | X | | |
| Control all firing actions on the facility. | X | X | |

Table 4-8. Range officer in charge responsibilities, example (continued)

| <i>Task</i> | <i>Before Training</i> | <i>During Training</i> | <i>After Training</i> |
|--|------------------------|------------------------|-----------------------|
| Ensure proper supervision of personnel performing misfire, hang-fire, and cook-off procedures. | X | X | X |
| Ensure all ammunition malfunctions and accidents are reported to range control according to AR 75-1 and AR 385-10. | X | X | X |
| Maintain all communications and ensures hourly radio checks with range operations firing desk, medic support, RSO, and NCOIC. | X | X | |
| Ensure safe laser operations. | X | X | |
| Ensure the live-fire training standards are met. | X | X | |
| Ensure information is maintained about pertinent safety and control data concerning the operation of firing ranges, weapons training facilities, and maneuver areas, authorized operating times, impact areas entries and exits, and cease fire authorizations (see table 4-30). | X | X | X |
| Close range through range operations (see Close Range). | X | | X |
| Verify range is cleared according to the installation's range SOP. | X | | X |
| Legend: AR – Army regulation, NCOIC – noncommissioned officer in charge, OIC – officer in charge, RSO – range safety officer, SOP – standard operating procedure | | | |

RANGE SAFETY OFFICER

4-32. The range safety is the officer, warrant officer, or NCO who is the direct representative of the OIC of firing or other operations. The RSO must be weapon or weapon system qualified and have successfully completed the installation's range safety certification course. The RSO reports to the OIC and is responsible for ensuring the adequacy during safety of firing, training operations, and ensuring compliance with laser range safety requirements and local SOPs. Personnel assigned as RSO will have no other duties during that period of training. Assistant range safety officers may be appointed, as required.

4-33. The RSO must meet the rank and experience requirements based on the type of training event planned, as outlined in AR 385-63/MCO 3570.1C and DA PAM 385-63, and shown in table 4-9.

Table 4-9. Individual, crew-served, and special purpose weapons minimum range safety officer appointment requirements

| <i>Weapon or Weapon System</i> | <i>RSO</i> | | |
|--|------------|-----------|------------|
| | <i>OFF</i> | <i>WO</i> | <i>NCO</i> |
| Small arms, machine guns, subcaliber devices, practice hand grenades, laser devices, simulators, trip flares, chemical agents, and smoke grenades. | X | X | SGT |
| Live grenades, grenade launchers, live mines, demolitions, recoilless rifles, direct fire antitank rockets, and missiles. | X | X | SSG |
| Notes. For more information concerning RSO requirements, see AR 385-63/MCO 3570.1C and DA PAM 385-63. Civilians in the grade of GS-05 or above or equivalent may act as RSO. Civilian contractors may serve as an RSO when approved by the installation commander according to the installation's policy and the contract statement of work. | | | |
| Legend: AR – Army regulation, DA PAM – Department of the Army pamphlet, GS – Department of the Army general schedule employee, NCO – noncommissioned officer, OFF – officer, RSO – range safety officer, SGT – sergeant, SSG – staff sergeant, WO – warrant officer | | | |

4-34. RSOs will be certified in the weapon systems for which they are responsible. For weapon systems equipped or dependent on lasers, the RSO will be knowledgeable of laser hazards and proper employment. The RSO holds responsibility and accountability for the safe conduct of the activity and the adherence to governing regulations and guidance.

4-35. The RSO must have successfully completed a range safety certification program. The range RSO must be appointed by a battalion or squadron commander and have successfully completed the supporting installation's range safety course, based on local policy. Table 4-10 shows the basic responsibilities of the OIC for small and medium caliber ranges.

Table 4-10. Range safety officer responsibilities, example

| Task | Before Training | During Training | After Training |
|--|-----------------|-----------------|----------------|
| Ensures RSO certification is valid. | X | | |
| Must be weapon or weapon system qualified. | X | | |
| Must have successfully completed a refresher of the weapon's Table I, Preliminary Marksmanship Instruction and Evaluation within 90-days of the live-fire event. | X | | |
| Receives range safety briefing from the installation range control organization on use of the ranges and training areas. | X | | |
| Participates in the range walk. | X | | |
| Participates in the range rehearsal. | X | | |
| Reviews range SOP and operating requirements. | X | | |
| Inspects range with OIC. | X | | |
| Ensures range guards are posted and briefed, as required. | X | | |
| Inspects ammunition storage, handling, and issue points. | X | | |
| Ensures all safety markers are present and visible on the range. | X | | |
| Conducts internal range sweeps, as required. | X | | |
| Conducts safety brief to training audience (see safety brief). | X | | |
| Ensures range guards are posted and briefed on live fire facilities. | X | | |
| Ensures no live ammunition is present on non-live-fire facilities. | X | X | |
| Ensures no blank ammunition is present on live-fire ranges | X | X | |
| Monitors ammunition issue, handling, and storage. | X | X | X |
| Legend: OIC – officer in charge, RSO – range safety officer, SOP – standard operating procedure | | | |

4-36. Prior to granting clearance to fire, the RSO must verify critical items and report to the OIC. The RSO must confirm the status of the range and coordinate the execution of training in a safe manner. The tasks listed in table 4-11 provide a brief description of the RSO's critical tasks before and during live-fire.

Table 4-11. Range safety officer critical tasks example

| <i>Task</i> | <i>Before Training</i> | <i>During Training</i> | <i>After Training</i> |
|--|------------------------|------------------------|-----------------------|
| Weapons and personnel are properly positioned. | X | X | X |
| Authorized ammunition and explosives are used. These include proper charge, fuze, and fuze settings. | X | X | |
| Firing settings and weapon systems are within prescribed safety limits and verified. | X | X | |
| SDZ is clear of all unauthorized personnel. | X | | X |
| Proper hearing protection is worn by personnel in noise hazard areas. | X | X | |
| Proper eye protection is worn by personnel in eye hazard areas. | X | X | |
| Permission is received from range control to commence training and live-fire operations. | X | | |
| Final coordination conducted with the OIC. This includes: <ul style="list-style-type: none"> • A summary of checks, inspections, and actions that the RSO has completed. • Verification that required communications has been established. • A "hot status" has been received from range control. | X | | |
| RSO is physically present at the training site. | X | X | X |
| Training is observed and monitored for any safety violations. | X | X | |
| Immediate cease fire or check fire ordered when any unsafe condition occurs. | X | X | X |
| All accidents and ammunition malfunctions are reported to the range OIC. | X | X | X |
| All weapons and weapon systems are verified clear and safe at completion of firing or firing order before allowing the removal of weapons from the firing area. | | X | X |
| Misfires are reported, as appropriate. | | X | X |
| Safety violations are reported to the OIC. | X | X | X |
| Note. The RSO may not have any additional duties or taskings during the conduct of the range. | | | |
| Legend: OIC – officer in charge, RSO – range safety officer, SDZ – surface danger zone | | | |

MEDICAL SUPPORT PERSONNEL

4-37. All commanders conducting live-fire training with individual, crew-served, and special purpose weapons must provide competent medical support personnel with the appropriate medical supplies, communication, and transportation assets. Table 4-12 describes the minimum medical personnel requirements for individual weapons training on a single range facility or training area. Additional requirements may be applied by the policies and procedures of the supporting installation. Units must review the policies and procedures of their supporting installation for additional information.

Table 4-12. Medical personnel requirements

| <i>Training Event Type</i> | <i>CLS Certified Soldier</i> | <i>91B or 91C Medic</i> | <i>Dedicated Wheeled Vehicle</i> | <i>Ground Medical Vehicle</i> |
|--|----------------------------------|-------------------------|----------------------------------|-------------------------------|
| Caliber .50 or smaller, single range | 1 each per 100 Soldiers training | | 1 each | |
| Demolitions, hand grenades, grenade launchers, antitank missiles | | 2 each | | 1 each |
| <p>Note. Combat lifesaver (CLS) bag must be complete. If a Soldier is medically evacuated, the minimum amount of remaining or replacement medical support personnel with ground transportation must still be available on the range or training location to continue training.</p> <p>For dedicated wheeled vehicles, a dedicated licensed driver, dual frequency radio capability (administration and logistics [ADMINLOG] and firing frequencies, minimum), and markings as a medical support vehicle must be included.</p> | | | | |

4-38. All live-fire training must cease in the event of an incident on the range facility that causes the medical support personnel and supporting vehicles to depart and, as a result, the minimum requirements on the facility cannot be maintained. Units may resume live-fire training once the required minimum medical support personnel with ground transportation has been obtained and reestablished on the facility. (See table 4-13.)

Table 4-13. Medical support personnel responsibilities, example

| <i>Task</i> | <i>Before Training</i> | <i>During Training</i> | <i>After Training</i> |
|--|------------------------|------------------------|-----------------------|
| Ensures medical certification is valid (medic or combat lifesaver [CLS]), based on training event requirements. | X | X | |
| Ensure medic or CLS certification card on-hand. | X | X | |
| Participate in the range walk-through and rehearsal. | X | | |
| Identify medical point on the range. | X | | |
| Ensure appropriate medical equipment is on hand, serviceable (see medical equipment). | X | | |
| Identify MEDEVAC landing zone (LZ). | X | | |
| Identify ambulance exchange points (AXP), as appropriate. | X | | |
| Ensure strip map to nearest medical treatment facility (military and civilian) is on hand and accurate. | X | | |
| Create a list of Soldiers attending training with hot and cold weather injuries. | X | | |
| Provide back brief on CASEVAC / MEDEVAC plan and procedures. | X | | |
| Ensure there is a posted standard 9-line MEDEVAC request at all communications systems and with leaders Sergeant and above. | X | X | X |
| Prepare communications equipment with range administration and logistics, firing, and MEDEVAC frequencies. | X | | |
| Ensure required wheeled or tracked ambulatory vehicle is operational, positioned in the assigned location, and appropriate licensed driver is on hand. | X | | |
| Establish and maintain communications with the Range OIC hourly on the designated frequency. | X | X | X |
| Ensure MEDEVAC / CASEVAC plan is known, rehearsed, and in place. | X | | |
| Ensure landing zone marking equipment is available and serviceable; includes equipment for night and limited visibility operations. | X | | |
| Ensure appropriate medical information is provided to the RSO for the safety briefing. | X | X | X |
| Maintain communication with range OIC. | X | X | X |
| Ensure medical NCOIC makes periodic checks of the training audience, based on weather conditions. | X | X | |
| Monitor heat index, weather conditions, and cold weather advisories to prevent heat and cold weather injuries. Notify OIC as environmental conditions dictate. | X | X | X |
| Legend: CASEVAC – casualty evacuation, MEDEVAC – medical evacuation, NCOIC – noncommissioned officer, OIC – officer in charge, RSO – range safety officer | | | |

4-39. Table 4-14 provides a general listing of CLS contents with additional items or equipment that units should consider including at the medic station. This list is not all-inclusive.

Table 4-14. Medical supplies and equipment for small arms ranges example

| <i>Item</i> | <i>Quantity</i> | <i>NSN</i> |
|---|-----------------|------------------|
| Bag, TC3, combat casualty care | 1 each | 6545-01-537-0686 |
| Atropine injection aqueous type 0.7ML syringe with needle | 5 each | 6505-00-926-9083 |
| Diazepam injection USP 5MG/ML 2ML syringe-needle unit auto inj | 5 each | 6505-01-274-0951 |
| Adapter catheter to Leur syringe short locking 5S | 2 each | 6515-01-519-5778 |
| Adhesive tape surgical porous woven 3 inches by 10 yards 4S | 1 roll | 6510-00-926-8884 |
| Airway nasopharyngeal 9mm ID 12mm OD kink res smooth round edges10S | 1 each | 6515-01-233-1917 |
| Bandage muslin compressed olive drab 37X37X52" triang with safety pins | 3 each | 6510-00-201-1755 |
| Bandage elastic flesh rolled nonsterile 6 inch by 4.5 yards 12S | 1 each | 6510-00-935-5823 |
| Bandage gauze cotton 6 ply white 4.5 inches wide 4.1 yards long | 2 rolls | 6510-01-503-2117 |
| Bandage kit elastic | 2 each | 6510-01-492-2275 |
| Bandage ADH.75X3" flesh / clear ster dress affixed to plas ADH100S | 5 each | 6510-00-597-7469 |
| Catheter IV introcan safety 18GAX1-1/4 inch large winged ndl Teflon 200S | 4 each | 6515-01-484-1327 |
| Catheter-ndl unit IV 14GAX3.25 inch Luer hub and ndl guard RADPQ 50S | 1 each | 6515-01-153-5373 |
| Dressing first aid field camouflaged 11.5-12 inch W 11.5-12 inch large | 1 each | 6510-00-201-7425 |
| Dressing occlusive adhesive clear 4.75 X 4 inch 5S | 2 each | 6510-01-519-8421 |
| Glove patient examining and treatment SZ 10 large purple 4.3MIL 100S | 4 each | 6515-01-491-5719 |
| Hetastarch in lactated electrolyte injection, 500ML | 2 each | 6505-01-498-8636 |
| Administration set infusion pump vented / unvented | 1 each | 6515-01-452-3445 |
| Lubricant surgical 5 gram 144S | 1 each | 6505-00-111-7829 |
| Oral rehydration salts USP 27.9GM foil packet 125 per package | 2 each | 6505-01-197-8809 |
| Pad isopropyl alcohol impregnated nonwoven cotton / rayon white 200S | 6 each | 6510-00-786-3736 |
| Pad povidone-iodine impre ster cotton / rayon 2 X 1.375 inch brown 100S | 6 each | 6510-01-010-0307 |
| Scissors bandage 7.25 inch lg ang to hdl 1.50 inch cut lg blunt pts crs | 1 each | 6515-00-935-7138 |
| Splint universal alum 36 inch o/a lg 4.25 inch w gray and olive drab reuse | 1 each | 6515-01-494-1951 |
| Syringe and needle hypodermic safety 3ML 23GA ster disp 25S | 1 each | 6515-01-519-5872 |
| Tourniquet nonpneumatic adult 14 X 1" bld taking dsgn rubber o/a | 1 each | 6515-01-146-7794 |
| Tourniquet combat application one-handed | 1 each | 6515-01-521-7976 |
| Tube drainage surgical penrose 1" X 18" rubber radiopaque ster 6S | 1 each | 6515-01-519-6764 |
| Legend: " – inches, ADH – adhesive, alum – aluminum., ang – angled, bld – blood, CRS – cross, DISP – dispenser, DSGN – design, GA – gauge, GM – gram, HDL – handle, inj – injector, lg – large, MG – milligram, ML – milliliter, ndl – needle, NSN – national stock number, o/a – on or about, pts – points, S – size, SFTY – safety, ster – sterile, triang –triangle, USP – United States Pharmacopeia, W – with | | |

4-40. Units may augment the minimum CLS bag with one or more warrior aid and litter kits, NSN 6545-01-532-4962. Its contents are listed in table 4-15 for reference.

Table 4-15. Warrior aid and litter kit additional medical equipment for small arms ranges example

| <i>Item</i> | <i>Quantity</i> | <i>NSN</i> |
|--|-----------------|------------------|
| Talcon II evac litter 90C | 1 each | 6530-01-504-9051 |
| Litter carrier | 1 each | 6530-01-531-6907 |
| Black Talon trauma gloves | 50 pair | 6515-01-515-0197 |
| Nasopharyngeal airway 28 FR w/lub | 1 each | 6515-01-529-1187 |
| Nasopharyngeal airway | 1 each | 6515-00-300-2900 |
| Petrolatum gauze 3X18 IN. | 1 roll | 6510-01-532-4289 |
| Petrolatum gauze | 2 rolls | 6510-00-202-0800 |
| 10-14 gauge 2.5-3 IN. catheters (2) | 2 sets | 6510-01-521-0910 |
| Needle decompression kit (14G X 3.25") | 1 kit | 6515-01-541-0635 |
| Combat application tourniquet | 1 each | 6515-01-521-7976 |
| Roller gauze vacuumed | 1 pack | 6510-01-529-1213 |
| Bandage kit elastic (trauma dressing) | 4 each | 6510-01-492-2275 |
| Emergency bandage-abdominal | 1 each | 6510-01-541-8121 |
| Dressing elastic abdominal | 1 each | 6510-01-532-6656 |
| Sam II universal splint 36 IN. | 2 each | 6515-01-494-1951 |
| Large trauma shears 7.25" | 1 each | 6515-01-538-9276 |
| Surgical tape nylon 2 IN. | 1 roll | 6510-01-532-4283 |
| Surgical tape nylon 2 IN. roll | 2 rolls | 6510-00-926-8883 |
| ACE wraps 6 IN. | 2 each | 6510-00-935-5823 |
| Cravats | 6 each | 6510-00-201-1755 |
| Kerlix | 4 each | 6510-00-058-3047 |
| Combat casualty reference card | 1 each | 6515-01-537-4161 |
| Narp T2 individual kit | 1 pack | 6545-01-537-3958 |
| Hypothermia prevention and management kit | 1 kit | 6515-01-532-8056 |
| Blanket heating 4-panel | 1 each | 6532-01-525-4062 |
| Blanket blizzard wrap | 1 each | 6532-01-524-6932 |
| Litter buckle replacement (1 male / 1 female) | 1 each | 6530-01-435-7337 |
| Panel marker, survival | 1 each | 8345-00-140-4232 |
| Litter retention strap set | 2 each | 6530-01-530-3860 |
| Legend: evac – evacuation, " – inch, IN – inch, NSN – national stock number, w/lub – with lubricant | | |

NONCOMMISSIONED OFFICER IN CHARGE

4-41. The NCOIC provides the OIC with an action officer on the range to assist in the proper, efficient operation of the range and orderly conduct of the training event. The NCOIC should be an experienced staff sergeant or sergeant first class who is weapon system certified or qualified. The NCOIC is responsible to the OIC for all actions. Table 4-16 lists the NCOIC's duties and responsibilities.

Table 4-16. Noncommissioned officer in charge responsibilities, example

| <i>Task</i> | <i>Before Training</i> | <i>During Training</i> | <i>After Training</i> |
|---|------------------------|------------------------|-----------------------|
| Reviews communications plan. | | | |
| Participates in the range walk. | | | |
| Conducts range rehearsal. | | | |
| Verifies range equipment available. | | | |
| Reviews and verifies concurrent training plan. | | | |
| Reviews range standard operating procedure and operating requirements. | | | |
| Sets up the concurrent training area. | | | |
| Supervises ammunition, target, and administrative details. | X | | |
| Supervises the communications setup for the range facility. | X | | |
| Inspects the concurrent training location. | X | X | |
| Inspects the ammunition issue point. | X | X | X |
| Supervises placing firers in the correct firing order or progression through the training event. | X | X | |
| Monitors the communications for the range. | X | X | X |
| Inspects the gate and barrier guards, as necessary. | X | X | X |
| Inspects the briefing noncommissioned officer. | X | X | |
| Controls movement of firing orders on and off the firing line / baseline, based on the directions from the officer in charge. | X | X | X |
| Ensures the training audience receives the range and safety briefings. | X | | |
| Supervises all details. | X | X | X |
| Monitors positions of all range personnel. | X | X | X |
| Coordinates, executes, and reports the status of firing order personnel. | X | | |
| Monitors the conduct of the range. | X | X | X |
| Supervises ammunition and target details. | X | X | X |
| Ensures policing of the firing line and range facilities. | X | X | X |

MARKSMANSHIP MASTER TRAINER

4-42. The MMT is the SME on the weapons and equipment used during the training event. The MMT provides the unit commander expertise on the training of all individual, crew-served, and special purpose weapons and their associated equipment. The MMT provides those skills to the range OIC during the training event on the range facility. Table 4-17 describes the MMT's duties and responsibilities on the range before, during, and after the training event is conducted.

Table 4-17. Marksmanship master trainer responsibilities example

| <i>Task</i> | <i>Before Training</i> | <i>During Training</i> | <i>After Training</i> |
|---|------------------------|------------------------|-----------------------|
| Ensures OIC / RSO certification is valid. | X | | |
| Participates in the range walk. | X | | |
| Conducts range rehearsal. | X | | |
| Verifies range equipment available. | X | | |
| Assists with weapons malfunctions. | X | X | X |
| Advises the OIC and NCOIC on conduct of the range. | X | X | X |
| Briefs ammunition NCO and detail on the appropriate ammunition breakdown per firer. | X | X | |
| Determines concurrent training changes based on firing unit performance. | X | X | |
| Identifies any surface danger zone violations and reports findings to RSO and OIC. | | X | X |
| Ensures quantifiable results are captured for future training assessments and unit training plans. | | X | X |
| Ensures range scenario, targetry, and training enablers are prepared for any follow-on training unit, as appropriate. | X | X | |
| Compiles all firing data, roll-ups, and reports for the OIC and unit commander. | | X | X |
| Updates any DA Form 2408-4 (<i>Weapon Record Data</i>), as appropriate. | | X | X |
| Compiles all qualification records and prepares commander out-brief / roll up based on the commander's intent and guidance. | | X | X |
| Ensures all misfires are reported and handled according to the appropriate regulations, technical manuals, and local policies and procedures. | | X | X |
| Legend: DA – Department of the Army, NCO – noncommissioned officer, NCOIC – noncommissioned officer in charge, OIC – officer in charge, RSO – range safety officer | | | |

4-43. The MMT is responsible for providing the appropriate equipment on the range facility. In the event an MMT is not assigned to the unit, the range NCOIC inherits the responsibility of providing the necessary equipment. Table 4-18 provides a detailed list of the most common equipment used on individual, crew-served, and special purpose weapons ranges.

Table 4-18. Range equipment common requirements (range box) example

| <i>Small Arms Training Equipment and Items Required at the Range Facility</i> | | | |
|---|-------------|--------------------|-----------------------|
| <i>Item</i> | <i>Unit</i> | <i>Tasked Unit</i> | <i>Range Facility</i> |
| OPORD for the training event. | X | | |
| Range regulations (required in the range tower) | X | | X |
| Weapon, system, optic technical and training publications. | X | | |
| Surface danger waivers, as required for the event. | | | X |
| Range scripts / tower book / briefing NCO book. | X | | |
| Range OIC and RSO certification cards or memorandums. | X | | Issued |
| Two forms of operational communications systems with batteries and charging station. | X | | X |
| Range support personnel communication. | X | | |
| Targets and target operating and control equipment. | | | X |
| Target repair equipment. | | | X |
| Score sheets for manual scoring. | X | | |
| Binoculars, spotting scopes, thermal optics for tower use. | X | X | |
| Night vision devices for range support personnel. | X | X | |
| Method of marking firing positions during limited visibility. | X | | |
| Firefighting equipment. | | | X |
| Concurrent training equipment, TADSS, or products. | X | | |
| Range flag, range light. | | | X |
| Engineer tape. | X | | |
| Compass. | X | | |
| Range maps, diagrams, as necessary | X | | |
| Firer training records (Table I, Table II, and Table III) | X | | |
| Armorer's tool kit, small arms repairman (NSN 5180-01-506-8287) | | X | |
| Legend: DA – Department of the Army, NCO – noncommissioned officer, OIC – officer in charge, OPORD – operation order, NSN – national stock number, RSO – range safety officer, TADSS – training aids, devices, simulators, and simulations | | | |

LANE TRAINER

4-44. The lane trainer is an experienced sergeant or team leader who can effectively assist a Soldier with the shot process. The lane trainer must have the ability to correct firer-induced errors in the shot process, including stability, aiming errors, optics alignment issues, and employment techniques and practices. The lane trainer directly supports the MMT, the NCOIC, and the range OIC. Table 4-19 provides a general list of the lane trainer's duties and responsibilities.

Table 4-19. Lane trainer(s) responsibilities example

| <i>Task</i> | <i>Before Training</i> | <i>During Training</i> | <i>After Training</i> |
|---|------------------------|------------------------|-----------------------|
| Ensure range safety officer (RSO) certification is valid. Lane trainer should be capable of providing RSO support, as necessary. | X | | |
| Conduct range rehearsal. | X | | |
| Review the respective training publication for the weapon(s) being trained on the facility. | X | | |
| Understand the zeroing procedure for the weapon and associated optics, pointers, illuminators, and lasers that will be employed during the training event. | X | | |
| Have the appropriate graphic training aids and alignment devices during training. | X | X | X |
| Have the appropriate technical manuals available during the training event. | X | X | X |
| Have any necessary weapons tools, cleaning materials, and lubricants available during training. | | X | X |
| Certify on the weapon procedures: <ul style="list-style-type: none"> • Load. • Clear. • Perform immediate action. • Perform remedial action. • Borelight. • Zero. • Align. • Perform functions check. | X | | |
| Provide remedial training on weapons-related tasks. | | X | X |
| Identify firer-induced errors in the shot process. | | | |
| Identify weapon, optic, pointer, illuminator, or laser malfunctions. | | | |
| Understand the scoring procedures for the training event. | X | X | |

BRIEFING NONCOMMISSIONED OFFICER

4-45. The briefing NCO provides an overview of the training event, objectives, tasks, conditions, and standards to visitors at the training location. They provide general information concerning the firing unit, the number of Soldiers trained, the equipment and weapons being trained, and the current status of training.

4-46. This NCO should be qualified on the weapon system and understand the training strategy for the weapon to best explain the status of training. The briefing NCO is a representative of the range OIC and NCOIC. They must have administrative communications with the tower, OIC, and NCOIC to remain abreast of the status of training to update their briefing, as appropriate.

4-47. The briefing NCO should be RSO-certified. This enables the OIC flexibility to change RSOs on the range to maximize the training on the range and provide a work-rest rotation for the RSO position. Table 4-20 lists the briefing NCO's general duties and responsibilities.

Table 4-20. Briefing noncommissioned officer responsibilities example

| <i>Task</i> | <i>Before Training</i> | <i>During Training</i> | <i>After Training</i> |
|---|------------------------|------------------------|-----------------------|
| Ensures RSO certification is valid. | X | | |
| Conducts range rehearsal. | X | | |
| Reviews the briefing book provided by the OIC, NCOIC, or MMT. Understand the records that must be maintained, recorded, or updated during the conduct of the training event. | X | | |
| Performs hourly communications checks with the tower, OIC, and NCOIC. | | X | |
| Confirms and updates the briefing book hourly. Ensure the accurate number of Soldiers trained, firers remaining, and outcomes. For qualification events, record and update the number of Soldiers trained to include the number of firers that are: <ul style="list-style-type: none"> • Expert. • Sharpshooter. • Marksman. • Unqualified. | | X | X |
| Maintains a centralized location on the range to receive all visitors to the range facility (entry control point). | | X | |
| Records and updates the key personnel on the range and knows their area of operation on the facility. | | X | |
| Ensures all visitors receive a conduct of the range and range safety briefing prior to moving on to the training complex. | | X | |
| Maintains the range layout and overview of the key training and concurrent training events. | | X | |
| Ensures familiarity with the proper customs and courtesies; reporting requirements to the OIC and NCOIC for personnel entering and leaving the range facility. | | X | |
| Maintains positive accountability of all senior leaders and VIP arrivals and departures from the range. | | X | |
| Serves as escort to VIPs as directed by the OIC or NCOIC. | | X | |
| Maintains positive control of the Briefing NCO book and current firing status of personnel on the range. | | X | |
| Legend: MMT – marksmanship master trainer, NCOIC – noncommissioned officer in charge, OIC – officer in charge, RSO – range safety officer, VIP – very important person | | | |

RADIO-TELEPHONE OPERATOR

4-48. The RTO is a recommended position dependent on the number of personnel expected for training and the complexity of moving elements on the range facility. If the unit anticipates a large number of firers (more than 100 Soldiers, or greater than eight firing orders), the unit should provide an RTO. The RTO will assist the range OIC in managing the firing orders, providing communications checks with range control, maintaining information about all aspects of the training event, and other administrative tasks.

4-49. The RTO, as well as all range support personnel, must be familiar with the common range communications terms and their meanings or definitions. Table 4-21 shows common terms used at many installations in regard to range status.

Table 4-21. Common range status terms example

| <i>Common Range Terminology</i> | |
|---------------------------------|--|
| <i>Range Status Term</i> | <i>Definition</i> |
| Cold | A range status indicating the range is not firing nor actively training. |
| Dry | |
| Hot | A range status indicating the range is actively training with live munitions. |
| Wet | |
| Check fire | Weapons are in a green or amber status with no firing authorized due to a potential hazard within the surface danger zone. |
| Green | Weapons are clear. Non-live-fire training may be conducted. |
| Amber | Weapons have ammunition available but are not being fired. |
| Red | Weapons are loaded; the unit is conducting live-fire events or tasks. |

4-50. The RTO assists establishing, maintaining, and closing the range's net control station, and manages the administrative and logistics frequency. Table 4-22 lists the RTO's duties and responsibilities on small arms ranges.

Table 4-22. Radio-telephone operator responsibilities example

| <i>Task</i> | <i>Before Training</i> | <i>During Training</i> | <i>After Training</i> |
|---|------------------------|------------------------|-----------------------|
| Ensure familiarity with the common range status terms, their definitions, meanings, and implications. | X | | |
| Establish and maintain communications to the supporting installation's range operations firing desk. | X | X | |
| Establish and maintain administrative and logistic frequencies at the range. | X | X | |
| Maintain positive communications hourly with: <ul style="list-style-type: none"> • Range operations • Range noncommissioned officer in charge (NCOIC). • Barrier guards. • Medic support personnel. • Range safety officer (RSO). | | X | |
| Maintain, update information on behalf of the range officer in charge (OIC). Radio telephone operator (RTO) transcribes all communications between: <ul style="list-style-type: none"> • Range operations and the range. • Range and range operations. • Range OIC and medical support. | | X | |
| Record any significant digital or analog in-bound or out-bound communications traffic that relates to the firing status (hot, wet, cold, dry, check fire, cease fire – see common range status terms, table 4-21). | X | X | X |
| Immediately notify the OIC when communications are lost between the tower and: <ul style="list-style-type: none"> • Range operations. • Range NCOIC. • Medical support. • Barrier guards. • Gate guard noncommissioned officer (NCO). | X | X | X |
| Notify immediately the OIC, RSO, and NCOIC when one of the following occur: <ul style="list-style-type: none"> • CEASE FIRE is announced or directed. • CEASE FIRE, FREEZE is announced. • CHECK FIRE is directed. • Any flash message is received. • Urgent or severe weather warning or similar message is received. | X | X | X |

AMMUNITION NONCOMMISSIONED OFFICER

4-51. The primary role of the ammunition point is to manage ammunition draw, issue, use, and turn-in. The unit's support platoon manages the issue and turn-in of all ammunition at the ammunition supply point (ASP) daily. The SME and range OIC will conduct inspections of the ammunition point periodically throughout the training days. The OIC coordinates for gathering ammunition expenditures for day and night operations on each training location. Table 4-23 provides the general duties and responsibilities of the ammunition NCO.

Table 4-23. Ammunition noncommissioned officer and detail, responsibilities example

| Ammunition Noncommissioned Officer (NCO) Responsibilities | | | |
|---|------------------------|------------------------|-----------------------|
| Task | Before Training | During Training | After Training |
| Ensures ammunition handling certification is current / valid. | X | | |
| Reviews training ammunition requirements for the training event. | X | | |
| Participates in the range walk. | X | | |
| Conducts range rehearsal. | X | | |
| Verifies range equipment available: <ul style="list-style-type: none"> • Magazines. • Tables. • Expended brass containers. • 2 each fire extinguishers (BC rated, 10 lbs.) • Tarpaulin covers for ammunition pads. | X | | |
| Ensures the ammunition point is established and maintained according to regulation and local policy. | X | X | X |
| Organizes training ammunition for issue to the firers in an efficient manner. | X | X | |
| Maintains accountability of all: <ul style="list-style-type: none"> • Ammunition issued to firers. • Turned in munitions. • Spent brass. • Links. • Accountable items (grenade pins, for example). • Dunnage. | X | X | X |
| Maintains and supervises the separation of brass, links, and damaged training munitions when turned in. | | X | X |
| Ensures no LIVE ammunition is present on non-live-fire facilities. | X | X | X |
| Ensures no blank ammunition is present on live-fire ranges | X | X | X |
| Legend: BC – fire extinguisher rating, lbs – pounds | | | |

4-52. Table 4-24 provides some critical ammunition point requirements that must be adhered to by the unit. Failing to follow these tasks or failure of the responsible leader to verify their status can result in Soldier injury or initiate immediate closure of the range by the installation's range operations or range safety personnel. The ammunition NCOIC must keep an accurate account of all ammunition present (use DA Form 5515 [Training Ammunition Control Document]) (See table 4-25 on page 4-33.)

Table 4-24. Ammunition critical tasks and inspection criteria, example

| <i>Ammunition Issue Point Requirements</i> | | | |
|---|------------|------------|-----------------|
| <i>Task</i> | <i>OIC</i> | <i>RSO</i> | <i>AMMO NCO</i> |
| Ammunition NCO is ammo handler certified and certificate is available. | Verified | N/A | N/A |
| Ensure hazard division (HD) placards are openly visible from all sides of the ammunition pad. (Check with your respective organization to find out how to obtain HD placards, as procedures may vary.) | N/A | Verified | X |
| HD placards reflect highest rated ammunition type on the ammunition pad / building. | N/A | Verified | X |
| Fire extinguishers and HD placards are available, serviceable, and meet minimum requirements. (Check with your respective organization to find out how to obtain fire extinguishers, as procedures may vary.) | N/A | Verified | N/A |
| Fire extinguishers have been inspected within the last 30 days, which should be verified on the Fire Extinguisher Recharge and Maintenance Record. (Check with your respective organization to find out how inspections are completed, as procedures may vary.) | | | |
| Fire extinguisher pressure level is shown in the green zone on the Bourdon gauge. The pin and tamper seal are intact (before use). | | | |
| Fire extinguishers (2 each BC rated, 10 pounds minimum) are available and serviceable at the ammunition pad / point | | | |
| Fire extinguishers are not blocked by other equipment on the ammo pad or issue point. Clearly visible. | | | |
| Legend: Ammo – ammunition, BC – fire extinguisher rating. NCO – noncommissioned officer, OIC – officer in charge, RSO – range safety officer | | | |

Table 4-25. Ammunition issue point requirements

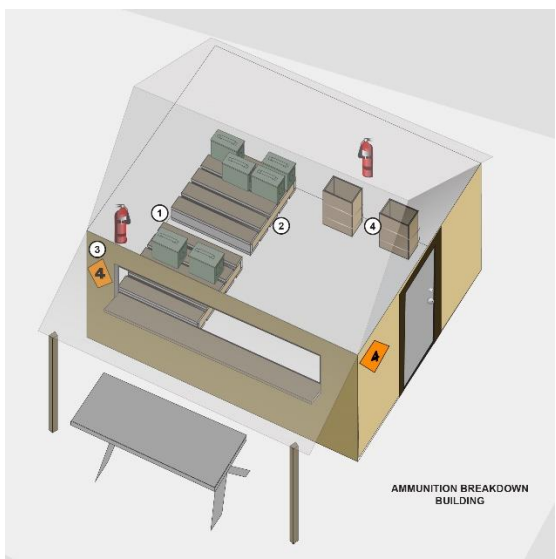
| Ammunition Issue Point Requirements | | | |
|--|---|------------|-----------------|
| Task | OIC | RSO | AMMO NCO |
| Ammo NCOIC keeps accurate account of all ammunition present (Use DA Form 5515, <i>Training Ammunition Control Document</i>). | | | Enforced |
| Ammo NCO must strictly enforce the ammunition issue point or ammunition pad guidelines: | | | Enforced |
| <ol style="list-style-type: none"> 1 Ammunition is separated by DODIC to facilitate accountability. 2 All ammunition must be elevated off the ammo pad surface with available dunnage or pallets to prevent moisture absorption and allow for appropriate ventilation. 3 Ammunition hazard division placards must be clearly visible on all four corners of the ammo pad. See the ammunition hazard divisions for a general overview. 4 Ammunition residue is clearly separated from live munitions. |  | | |
| Ammo personnel are not authorized to relink or delink | | Verify | Enforced |
| Tarps or other available means are present to protect ammunition from the elements and direct sunlight. | | | As required |
| Ensure proper distance is being maintained for flammables and combustibles <ul style="list-style-type: none"> • No smoking within 50 feet (signs required). • No refueling operations conducted within 50 feet. • No bulk fuel (> 500 gallons) within 100 feet of ammunition. | | Verified | Enforced |
| Ammunition is only unpackaged, as needed. | | | Enforced |
| Blank and live ammunition are separated on two different ammo locations, occupied by two separate ammo details. (Blank and live ammo can never be used or stored together) | Verified | Verified | |
| Legend: > - greater than, ammo – ammunition, DA – Department of the Army, DODIC – Department of Defense identification code, NCO – noncommissioned officer, NCOIC – noncommissioned officer in charge, OIC – officer in charge, RSO – range safety officer | | | |

4-53. Distribution of ammunition to personnel will occur only in areas designated for that purpose (for example, ready lines, firing lines, attack positions, assembly areas, or defilade positions).

Note: Blank and live-fire ammunition will not be stored in or issued from the same location at the same time.

4-54. The quantity of ammunition unpacked for training will be kept to the minimum number of rounds needed for efficient firing of the exercise. Packaging material, bandoliers, and other materials will be retained until firing is complete. Units will not burn wooden containers or indiscriminately fire or dispose of ammunition to preclude its return to a storage facility. Broken or unserviceable munitions or pyrotechnics will be handled according to range SOPs of the installation.

4-55. All ammunition unpacked for firing but not fired will be repackaged into its original packing configuration prior to return to the ASP. Ammunition that is easily degraded by short-term exposure to moisture (such as propelling charges, pyrotechnic signals, and simulators) will be unpacked only for the minimum amount of time consistent with mission requirements.

4-56. Units are responsible for turning in all dunnage, spent cartridge casings, and any unused ammunition at the end of training. To reduce turn-in time and maximize efficiency during this process, units should ensure they do not open more ammunition cases than they need to complete the current firing table.

LANE SAFETIES

4-57. The lane safeties support the RSO with ensuring the safe and expedient conduct of the firing order. They assist the RSO with verification of firer's weapons safety status (known as WSS), weapons orientation, and confirmation of green status, when directed. The lane safeties general responsibilities are listed in table 4-26.

Table 4-26. Lane safeties responsibilities example

| <i>Lane Safety Responsibilities</i> | | | |
|---|------------------------|------------------------|-----------------------|
| <i>Task</i> | <i>Before Training</i> | <i>During Training</i> | <i>After Training</i> |
| Ensures range safety officer (RSO) certification is valid. | X | | |
| Reviews and understands the firing sequence for the training event. | X | | |
| Conducts range rehearsal. | X | | |
| Must be weapon system qualified. | X | | |
| Assists the RSO during the execution of the training event. | | X | |
| Ensures the safe conduct of the training event by enforcing safety standards. | X | X | X |
| Ensures weapons and personnel are properly positioned. | X | X | X |
| Ensures firing settings and weapon systems are within prescribed safety limits and verified. | X | X | |
| Ensures surface danger zone is clear of all unauthorized personnel. | X | | X |
| Ensures proper hearing protection is worn by personnel within noise hazard areas. | X | X | |
| Ensures proper eye protection is worn by personnel within eye hazard areas. | X | X | |
| Observes and monitors training for any safety violations. | | X | X |
| Orders immediate cease-fire or check fire when any unsafe condition occurs. | | X | X |
| Reports all accidents and ammunition malfunctions to the range RSO and officer in charge (OIC). | | X | X |
| Verifies, upon completion of firing or firing order, to the RSO and OIC that all weapons and weapon systems are clear and safe before allowing the removal of weapons from the firing area. | | X | X |
| Reports misfires as appropriate. | | X | X |
| Reports any safety violations to the OIC. | X | X | X |

TARGET NONCOMMISSIONED OFFICER AND DETAIL

4-58. The target NCO and detail are typically only used during Table IV, Basic, training events for individual, crew-served, and special purpose weapons. They are used to install, repair and remove target frames, and authorized targetry on demand and at the direction of the OIC and NCOIC. Table 4-27 lists their duties and responsibilities.

Table 4-27. Target noncommissioned officer and detail responsibilities example

| <i>Target Noncommissioned Officer (NCO) Responsibilities</i> | | | |
|---|------------------------|------------------------|-----------------------|
| <i>Task</i> | <i>Before Training</i> | <i>During Training</i> | <i>After Training</i> |
| Review target requirements for the training event. | X | | |
| Maintain positive control of targetry, target frames, and any tools required to install the targetry. | X | X | X |
| Respond to the guidance and direction of the noncommissioned officer in charge (NCOIC) and officer in charge (OIC). | X | X | X |
| Report on the status of remaining targetry to the NCOIC and OIC in the event quantities are limited. | X | X | X |
| Install, repair, and remove targetry as required by the scenario or on direction of the NCOIC or OIC. | X | X | |
| Provide a detailed list of materials used during the conduct of the training event for replacement ordering. | | | X |

FIREFIGHTING DETAIL

4-59. The firefighting detail comes from the completed or latter firing orders on direction of the range NCOIC or OIC. They are used to control small fires on the range footprint, typically caused by ricochet or tracer rounds. Table 4-28 describes the basic duties and responsibilities of the firefighting detail.

Table 4-28. Firefighting detail responsibilities example

| <i>Firefighting Detail Responsibilities</i> | | | |
|---|------------------------|------------------------|-----------------------|
| <i>Task</i> | <i>Before Training</i> | <i>During Training</i> | <i>After Training</i> |
| Identified during the conduct of the range briefing by firing order number. | X | X | |
| Know the rally point when the detail is required by the officer in charge (OIC). | X | X | |
| Know where the firefighting equipment is located on the range. | X | X | |
| Maintain the appropriate personal protective equipment: <ul style="list-style-type: none"> • Gloves. • Water. • Wet weather gear. • Eye protection. • Other installation or unit requirements. | X | X | X |
| Know the communication plan before, during, and at the completion of firefighting tasks. | X | X | X |

GUARD OR BARRIER NONCOMMISSIONED OFFICER AND DETAIL

4-60. The barrier or guard NCO is responsible for the closure of all access points to the SDZ of the training range based on the installation's range SOP requirements. They establish and maintain the access control point to the range facility footprint. The barrier or guard NCO also control access on and off the range facility by the training audience, visitors, and other units.

4-61. All normal vehicular and foot traffic approaches to ranges and impact areas will be guarded by range guards, properly instructed in their duties, or closed off by appropriate barriers, as determined by the installation rifle combat optic (known as RCO). When barriers are used, appropriate signs will be posted. Table 4-29 lists the guard or barrier NCO duties and responsibilities.

Table 4-29. Guard or barrier noncommissioned officer responsibilities example

| <i>Guard or Barrier Noncommissioned Officer (NCO) Responsibilities</i> | | | |
|---|------------------------|------------------------|-----------------------|
| <i>Task</i> | <i>Before Training</i> | <i>During Training</i> | <i>After Training</i> |
| Receive briefing by the installation range operations. | X | | |
| Review communications plan. | X | | |
| Participate in the range walk. | X | | |
| Conduct range rehearsal. | X | | |
| Verify range equipment available. | X | | |
| Identify barrier checkpoints and conduct a route recon in coordination with range operations. | X | | |
| Report time required to close all required barriers to the officer in charge (OIC) for backwards planning. | X | | |
| Plan for appropriate start point (SP) of all barrier guards based on time required to meet the intended first round downrange time. | X | | |
| Establish all barrier points prior to hot or wet status. | X | | |
| Establish and maintain communications with all barriers, guard posts, range safety officer (RSO), and the range OIC. | X | X | X |
| Properly dispatch required vehicles and ensure they have the appropriate communications equipment, and class I available. | X | | X |
| Rehearse and verify alternate means of communication with the RSO and OIC. | X | X | |
| Ensure road guards have the appropriate safety vests, flashlights, signaling devices, warning markings, and closure signs. | X | X | X |
| Conduct hourly radio checks from the establishment through the closing of required barrier points. | X | X | X |

PREPARING FOR LIVE-FIRE RANGES

4-62. Once the planning phase is complete and the OPORD for the training event is issued, the tasked range personnel must prepare for the training event. For live-fire events, there are several specified and implied tasks that must be accomplished to ensure the safe, effective, and efficient execution of the training event. This section highlights some key preparatory tasks.

REVIEW OFFICER-IN-CHARGE / RANGE SAFETY OFFICER ROSTERS

4-63. The unit commander and first sergeant should review the current list of certified RSOs and OICs in the unit. Units should ensure all staff sergeants and above are certified annually through range operations. For units firing on nontenant installations, the commander or first sergeant must coordinate for range safety certifications on the approved training installation.

VERIFY DA FORM 581

4-64. The unit S-3 ammunition NCO verifies all DA Form 581 information supporting the ammunition draw for the live-fire training event. This includes any DA Form 581s (or electronic-DA Form 581s) that are created to support the draw and use of “in-lieu-of” ammunition types for use during high-fire-hazard periods. Units should confirm that personnel have their ammunition handler certifications to ensure sufficient unit coverage on all training facilities, complexes, and areas during the upcoming event.

RANGE COMMUNICATIONS

4-65. The installation range officer controls all ranges by wire and radio to obtain clearance to fire weapons, report, coordinate, and call cease-fire. The OIC controls all training activities, including firing, by the best means available. In all cases, the OIC plans for a backup communications system.

4-66. The unit develops a communications plan to ensure positive control of the barrier detail at all required locations. The unit must include a communications plan that ensures direct contact and coordination with target detail NCO, guard / barrier NCO, range NCOIC, AAR facility, and other key leaders.

4-67. The unit S-6 is expected to establish all communications requirements for the qualification range. This includes detailing all required range frequencies, providing administrative communication support, and digital communications requirements. Units must check with range operations to determine any additional communications requirements that are not provided by the range facility.

RANGE WALK

4-68. Leaders conduct a range walk of the training facility prior to the training event to become familiar with the range’s capabilities, structures, support buildings, and the ROCA. In general, small arms facilities include a small ROCA. Understanding the small ROCA layout and function enable smooth execution of the training event. Figure 4-2 provides a general layout of the ROCA, and includes key notes for leaders to consider during the planning and preparation of the event.

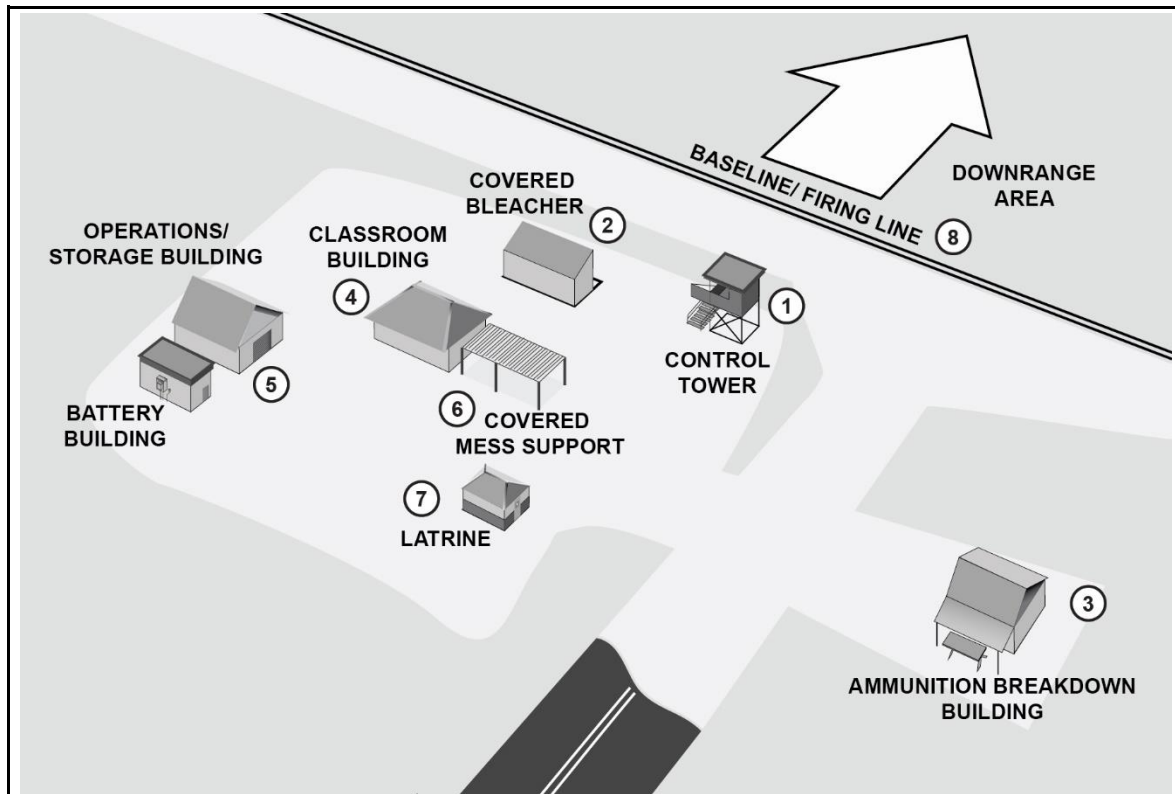

| Name | | Review and Verify |
|------|------------------------|---|
| 1 | Control tower | Type of software and any training required for operation. Will target operator be provided by range operations or unit? |
| 2 | Covered bleacher | Potential concurrent training location. Typically, can support 100 Soldiers. Useful during inclement weather? |
| 3 | Ammunition breakdown | Space available and maximum amount of ammunition authorized by type. Identify any tables, pallets, fire extinguisher, or other requirements. |
| 4 | Classroom building | Area capable of supporting concurrent training or inclement / warming area. |
| 5 | Operations and storage | Targetry, staple guns, staples, and other materials provided by the facility. Coordinate with range operations for equipment and any required target details. |
| 6 | Covered mess+ | Number of Soldiers supported. Capability for concurrent training location, weapons cleaning. |
| 7 | Latrine | Unit supply responsibilities? Contractors or Soldier cleaned and resupplied. |
| 8 | Baseline | Number of authorized firing positions. How they are marked / identified day and night. |

Figure 4-2. Small arms range operations control area facilities, example

REHEARSALS

4-69. The unit executes rehearsals of the training event including back briefs from key leaders and staff. Units should conduct a thorough rehearsal of the training event to identify potential issues as early as possible and provide sufficient reaction time to correct any deficiencies or shortcomings. Training and completion of prerequisite tables continues through this week / month.

CONCURRENT TRAINING

4-70. Plan and prepare for concurrent training for the Soldiers to execute while awaiting their firing order. Leaders should consider the overall number of Soldiers firing, the number of lanes identified for use, and determine the time required for one complete iteration of a firing order. Typically, small arms ranges have a large training audience with limited firing points. This throughput restriction creates several firing orders that can receive concurrent training while awaiting direction to the baseline for their firing order. To maximize the Soldier's time and training benefit, concurrent training may consist of mandatory training requirements typically conducted in garrison. Figure 4-3 is an example of a concurrent training plan.

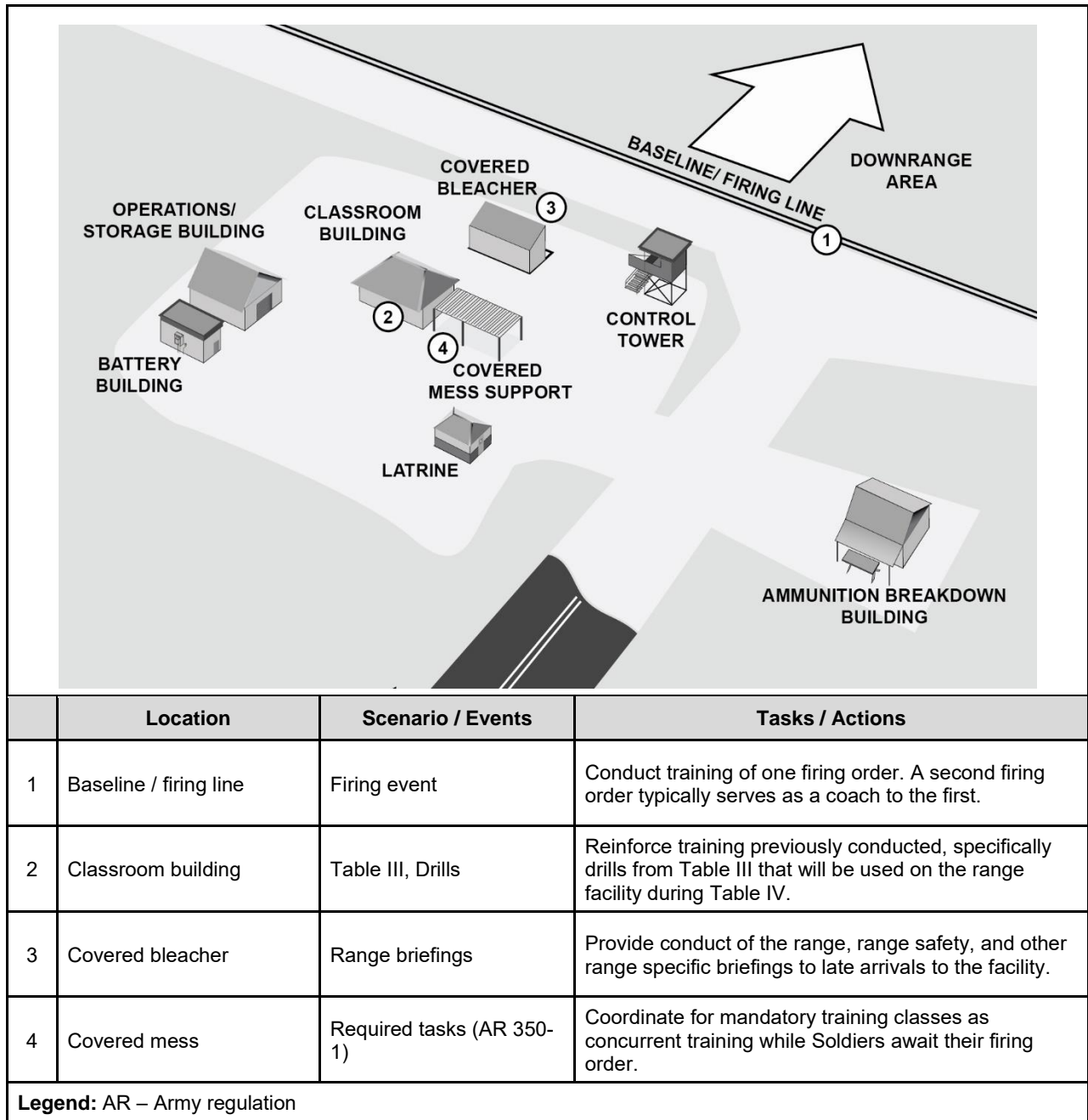

Figure 4-3. Concurrent training plan, example

EXECUTION

4-71. The execution of the training event begins with the OIC and RSO arriving on the range to establish their mission command cell in the tower. This section describes actions on the range by the owning unit upon arrival. For simplicity, this section describes a unit training on an MRF facility for eight hours. Once on the range, the OIC, RSO, MMT, NCOIC, and RTO (if assigned), will inspect the range facility. Once complete, they will report OPENING the range to the range operations firing desk as directed in the installation's range SOP.

INSPECTING THE RANGE

4-72. Once on the range, the OIC, RSO, MMT, NCOIC, and RTO (if assigned), will inspect the range facility. The inspection should be conducted with range operations personnel to ensure the facility is in acceptable condition prior to the range opening.

4-73. If the unit has conducted a range reconnaissance during the planning and preparation phase, the range inspection should only require 30 minutes. Once the OIC is satisfied with the condition of the range, the OIC and RTO establish positive control of the range tower.

OPENING THE RANGE

4-74. The OIC contacts the range operations firing desk through the primary means of communication as directed in the range SOP. The OIC reports the range is OPEN, which informs the firing desk the unit is prepared to occupy and use the scheduled range facility. The following actions are conducted by the unit when opening the range facility—

- The OIC—
 - Moves to the range or training site before the training unit arrives.
 - Checks communications and ensures backup communications are available.
 - Ensures range equipment is present and operational.
 - Ensures barrier sweeps are conducted, if necessary.
 - Conducts safety specific checks with the RSO.
 - Prepares to open the range with all required training information:
 - Unit.
 - Range Number / Identifier (locally established).
 - Number of Soldiers for training.
 - Ammunition type for training by Department of Defense identification code (DODIC).
 - OIC certification date and initials.
 - RSO certification date and initials.
 - Ensures red range flag with red beacon are prepared to deploy.
 - Reports opening of the facility to range control. Requests “OPENING COLD TIME.”
- The NCOIC—
 - Sets up the concurrent training area.
 - Supervises ammunition, targets, and administrative details.
 - Supervises the communications setup for the range.
 - Inspects the gate guards.
- The RSO—
 - Ensures range guards are posted and briefed on live-fire ranges.
 - Ensures no live ammunition is present on a nonfiring range.
 - Inspects ammunition storage and handling.
 - Ensures all safety markers are present and visible on the range.
 - Conducts internal range sweeps, as required.

4-75. The OIC provides to the firing desk the following typical information (each installation’s opening information may vary slightly) about their actions while preparing to begin firing (see table 4-30 for an example of typical information the firing desk will need):

- Established primary communications with range operations reporting opening time.
- Reported opening.
- Unit.
- Personnel to be trained.
- Ammunitions.

- OIC range certification.
- RSO certification.
- Request opening cold time.
- Posted red range flag and beacon.
- Firing flag displayed.
- Barrier guards posted—positive communications with tower.
- Request occupation time.
- Received occupation time.
- Training unit arrived on the range.
- Directed training unit to bleachers.

Table 4-30. Typical opening information, example

| <i>Time In</i> | <i>Time Out</i> | <i>Event/Information, Other.</i> | <i>Action</i> |
|----------------|-----------------|--|----------------------------|
| 0630 | | Established primary communications with range operations. Reported opening time 0630 | Reported opening |
| | | Unit: A/2-37AR, OSCAR 9 | |
| | | Ammunition: AB57, 5.56 mm ball | |
| | | Personnel to be trained: 200 | |
| | | OIC range cert: 15 JAN 19, TANGO MIKE PAPA | |
| | | RSO cert: 15 JAN 19, SIERRA JULIET PAPA | |
| 0635 | | Request opening cold time | Received opening cold time |
| 0640 | | Posted red range flag and beacon | Firing flag displayed |
| 0645 | | Barrier guards posted—positive communication with tower | Guard posted |
| 0646 | | Request occupation time | Received occupation time |
| 0650 | | Training unit arrived on the range | Directed to bleachers |

4-76. Units need to maintain information such as pertinent data and events occurring on the range as shown in table 4-30.

RANGE OCCUPATION

4-77. Range occupation is when the main body of the training unit arrives on the range or training area. For individual weapons training at small arms ranges, this usually is a minimum of one hour prior to the earliest time before first round downrange. Depending on the installation and season, first round downrange time for day firing is 0800 hours.

4-78. Units occupy the range according to local installation policy. The OIC ensures all Soldiers are in the proper uniform, ammunition has been issued to firers, and the unit or RSO has received a “hot” or “wet” firing status from the range operations firing desk allowing the range to go live.

4-79. The OIC continues to maintain information about the training event, including every event the unit experiences throughout the training period (see table 4-30).

4-80. The range is opened and occupied according to local range SOP, unit SOP, and unit GUNSOP. The following personnel are responsible for the sequence of events used to open the range and occupy the training site:

- The OIC—
 - Makes hourly communications checks with range operations firing desk.
 - Provides range orientation briefing.
 - Inspects the ammunition point.
 - Reports occupation and requests “hot” or “wet” firing status for the range facility.
- The NCOIC—

- Sets up the concurrent training area.
- Supervises ammunition, targets, and administrative details.
- Supervises placing firers in the correct order for firing or progression through the training event.
- Supervises firing order management, throughput, and movement.
- Supervises the communications set-up for the range.
- Inspects the gate guards.
- The RSO—
 - Briefs all personnel on range safety.
 - Ensures range guards are posted and briefed on live fire ranges.
 - Ensures no live ammunition is present on a nonfiring range.
 - Inspects ammunition storage, handling, and issue.
 - Ensures all safety markers are present and visible on the range.
- Medical support—
 - Ensures MEDEVAC / CASEVAC plan known, rehearsed, and in place.
 - Ensures AXP is known with appropriate strip-map available.
 - Ensures strip map complete and provided to all local military and civilian medical treatment facilities.
 - Ensures landing zone marking equipment is available and serviceable; include equipment for night and limited visibility operations.
- The Ammunition NCO—
 - Ensures the ammunition issue point is established according to regulation and local policy (see figures C-5 and C-6 on pages C-8 and C-9).
 - Organizes training ammunition for issue to the firers.
 - Maintains accountability of all ammunition issued and turned in.
 - Maintains and supervises the separation of brass, links, and damaged training munitions when turned in.

RANGE BRIEFS

4-81. The OIC and RSO ensure the entire unit is collected together to receive both the safety brief and conduct of the range/orientation brief. All Soldiers at the range will receive this brief prior to the conduct of any training or additional duties.

Safety Brief

4-82. The range RSO will conduct a safety briefing for each training event (day and night) according to the unit SOP and installation or division requirements. Units tailor their safety brief to match the training being conducted and, at a minimum, the following subjects will be covered:

- Safe weapons handling.
- Rules of firearms safety.
- Weapon safety status.
- Weapons control status.
- Environmental safety considerations outlined in DD Form 2977.
- Inclement weather, fire, lightning, tornados, and earthquakes.
- Interaction with wildlife on the range.
- Harassment of wildlife.
- Firing at wildlife in the impact area downrange.
- Every Soldier is a safety officer.
- Stopping unsafe acts as they are witnessed.

- Training accidents are unnecessary, erode the unit's readiness, and detract from the unit's overall mission.
- Uniform at the range.
- Method of marking and identifying all key personnel (RSO, OIC, medical personnel, and lane safeties).

Range Orientation

4-83. The range OIC will conduct a range orientation / conduct of the range briefing for each training event (day and night) according to unit SOP and installation or division requirements. This brief begins with orienting the unit to the range, its buildings, the firing line, the ammunition point, tower location, and so forth. The brief continues with the conduct of training, movement of firing orders on and off the firing line, ammunition issue and turn-in, managing throughput, the conduct of concurrent training, and the conduct of remedial training for Soldiers that fail to meet the standard. The next two sections outline the minimum required topics to be addressed in a range orientation or conduct of the range brief. OIC begins the brief by introducing themselves and physically pointing out or walking the unit to the following locations, and they may add topics to this list as required but must, at a minimum, contain the topics shown below.

- Assembly area.
- Tower.
- Firing line (up range and downrange).
- Latrines.
- Ammunition point.
- Location of medical support personnel.
- Range entry point.
- Off limits buildings (if applicable).
- Concurrent training site.

Conduct of the Range Briefing

4-84. The OIC continues the range brief by covering the following topics regarding the general flow of the range from occupation to closure:

- State intended training outcomes and commander's intent.
- Provide specific guidance about the conduct of the range with regard to the weapon being trained.
- Explain conduct of the throughput for pre-established firing orders from the ammunition point, to the queue, to the firing line, and back to the ammunition point to turn in dunnage and return unused ammunition.
- Explain conduct of concurrent training.
- Explain conduct of mandatory training during downtime.
- Explain conduct of remedial training, as required.
- Explain conduct of weapons maintenance.
- Police the range at the end of the training event.
- Prepare the unit for movement back to their operations facility.
- Explain conduct of the range according to local installation policy.

4-85. Once the OIC is satisfied the training unit is prepared to conduct the event and all critical personnel are in their assigned positions, the OIC requests a hot time and conducts the training event. Table 4-31 shows examples of the information about range occupation and the first round downrange that the OIC requires.

Table 4-31. Occupation, hot time, and first round downrange, example

| <i>Time In</i> | <i>Time Out</i> | <i>Even/Information, Other.</i> | <i>Action</i> |
|----------------|-----------------|---|---|
| 0700 | 0730 | OIC, RSO, and NCOIC provided range safety, range orientation, and conduct of range briefings | Provided briefings |
| 0735 | | Ammunition point established, inspected by RSO and OIC | Verified ammo checklist |
| 0740 | | Concurrent training site established by NCOIC | TADSS and training plan inspection by NCOIC |
| 0745 | | Medical support positioned on range positive communications with range ops, medics RSO, NCOIC | Inspected medics |
| 0755 | | Directed first firing order to baseline and firing point | Prepared for first round down |
| 0759 | | Request hot time from range control | Received hot time at 0800 |
| 0800 | | OSCAR 9 HOT | Informed RSO, NCOIC, training unit |
| 0803 | | First round downrange | Initiated firing order |
| 0810 | | 1st firing order complete, Table V | Tower updates briefing NCO |
| 0817 | | 2nd firing order complete, Table V | Tower updates briefing NCO |
| 0824 | | 3rd firing order complete, Table V | Tower updates briefing NCO |
| 0831 | | 4th firing order complete, Table V | Tower updates briefing NCO |

DURING THE LIVE-FIRE TRAINING EVENT

4-86. The following personnel are responsible for certain events during the conduct of the exercise:

- The OIC, with assistance from the unit MMT or other experienced NCO—
 - Controls the firing of the live-fire event.
 - Maintains all required communications and ensures hourly checks with range operations firing desk.
 - Ensures the live-fire training standards are met.
- The NCOIC—
 - Supervises all details.
 - Controls the movement of personnel from firing positions to concurrent training and other administrative areas.
 - Knows the location of other key personnel.
 - Knows how the range is being conducted.
 - Coordinates all firers in the ready line.
 - Coordinates, executes, and reports status of all additional required dry tasks to the tower.
- The RSO—
 - Ensures misfires are handled according to safety regulations.
 - Observes and monitors training for any safety violation.
 - Verifies WSS once firers exit the firing line upon completion of training.
 - Has no additional duties assigned.

- The briefing NCO—
 - Knows the location of other key personnel.
 - Is aware of how the range is being conducted.
 - Maintains a record of training completed.
 - Knows how many personnel are on the range.
- The MMT—
 - Assists with weapon malfunctions.
 - Advises OIC on conduct of the range.
 - Determines concurrent training changes based on firing unit performance.
 - Leverages knowledge of ballistics to assist investigation of SDZ violations.
 - Ensures live-fire event is conducted and evaluated according to standard.
 - Ensures quantifiable results are captured for future assessment.
 - Ensures range scenario, targetry, and training enablers are prepared for any follow-on training unit, as appropriate.
 - Compiles all firing data, roll ups, and reports.
 - Updates DA Form 2408-4, as appropriate.
 - Compiles all qualification records and prepares commander out brief / roll up, based on the commander's intent and guidance.
 - Ensures all misfires are reported and handled according to the appropriate regulations, technical manuals, and local policies and procedures.

MALFUNCTIONS

4-87. If a malfunction occurs, the Soldier must apply immediate action and continue the engagement. If the Soldier cannot reduce the malfunction with immediate action, they must safely perform remedial action. If the malfunction cannot be corrected the Soldier informs the lane safety:

- Once the Soldier reduces the malfunction, they continue firing, beginning with the next task.
- The course of fire *is not paused* to accommodate immediate or remedial actions.
- If the weapon must be replaced or repaired, the OIC may grant a refire.

Note. When malfunctions occur on the range, the Soldier must perform the appropriate corrective action and continue to engage the threats presented. It is critical the Soldier understands the importance of maintaining their weapon, magazines, and other equipment to the highest standard. If a mechanical malfunction occurs during the event, the weapon must be cleared (if possible) and turned in to the unit Armorer for verification and potentially a new weapon or equipment.

4-88. Rationale – rounds remaining for a firer indicates a weapon malfunction or the firer's failure to engage all targets presented. Rounds remaining at the end of the course of fire provide a training opportunity for slow-fire, extended range engagements. No credit for targets hit during this slow-fire iteration is authorized. The following terms are defined for clarity:

- Targetry or range malfunction – These occur during the course of fire, where the range OIC verifies when a target fails to operate as intended, habitually fails to record hits, or is improperly presented to the firer due to no fault of the firer.
- Weapon malfunction – This is a disruption of the weapon's cycle of function that can be remedied by the firer through the appropriate application of immediate action. When a weapons malfunction occurs during the course of fire, the Soldier is required to apply the appropriate immediate action and continue the engagements. Sufficient time is available between target presentations to perform immediate action and continue with the course of fire.
- Nonmission capable (known as NMC) weapon – This is a verified fault of a weapon which, according to the technical manual, deadlines the weapon from further use and requires direct support or higher maintenance. If a Soldier experiences more than one malfunction, the range OIC

- directs inspection of the weapon. If the weapon is found to be NMC for reasons beyond the control of the Soldier, they are authorized to refire the entire course of fire.
- Refire – This occurs when during the course of fire and through no fault of their own, a firer experiences a target or range malfunction or a weapon malfunction results in a weapon that is verified as NMC. In either case, the Soldier will refire the entire course of fire. The Soldier returns to the ammunition issue point, turns in unused ammunition for accountability, and is issued the ammunition authorized for the course of fire. If a full mission-capable (FMC) weapon is required, the Soldier must be provided the opportunity to group, zero, and confirm at distance prior to refiring the event.
- Alibi – Target(s) are presented at the end of the course of fire. When any firer has rounds remaining at the end of the course of fire, it indicates that the Soldier did not engage all the targets presented. This could occur for a number of reasons. Alibi targets are presented at 250 meters and 300 meters for Soldiers who have rounds remaining at the completion of the course of fire. Any hits or misses on alibi targets are not included in the results of the course of fire. Alibi fires are solely for slow-fire, extended range engagements for the Soldier.

CLOSING THE RANGE

4-89. The following personnel are responsible for specific events while closing the range:

- The OIC—
 - Notifies range operations that firing has ceased.
 - Ensures the range or training area is cleared according to local regulations and SOPs.
 - Debriefs unit leadership on the conduct of the range.
- The RSO—
 - Ensures all weapons are cleared.
 - Assists the MMT with misfire reporting and handling.
- The Ammunition NCOIC—
 - Ensures no ammunition is removed from the range by anyone other than authorized personnel.
 - Prepares residue certificates required by the ammunition supply point (installation requirements).
 - Accounts for all remaining munitions, dunnage and brass collection requirements.
 - Reports to the OIC once the ammunition issue point or ammunition pad has positive accountability of munitions and is closed to the training unit.
- The MMT—
 - Ensures range scenario, targetry, and training enablers are prepared for any follow-on training unit, as appropriate.
 - Compiles all firing data, roll ups, and reports.
 - Updates DA Form 2408-4, as appropriate.
 - Compiles all qualification records and prepares commander out brief / roll up, based on the commander's intent and guidance.
 - Ensures all misfires are reported and handled according to the appropriate regulations, technical manuals, and local policies and procedures.

4-90. Table 4-32, on page 4-48, is an example of information that units must provide as the OIC prepares to transition the range facility to a cold status, followed by closing the range for training. The installation range SOP will provide a by-line report for units to follow for their range closing procedures.

Table 4-32. Range closure entries, example

| <i>Time In</i> | <i>Time Out</i> | <i>Event/Information, Other.</i> | <i>Action</i> |
|----------------|-----------------|--|---------------------------|
| 1555 | 0730 | Requested cold time—training complete | Cold time received |
| | | Unit: A/2-37AR, OSCAR 9 | |
| | | Personnel trained: 213 | |
| | | Ammunition expended: Ammunition: AB57, 5.56 mm ball--17,460 rounds | |
| 1600 | | Ammunition issue point accountability 100 percent | Verified ammunition count |
| 1606 | | RSO verified all weapons green, no brass, no ammo | Verified green and clear |
| 1612 | | NCOIC cleared range and administrative areas complete | |
| | 1615 | Training unit departed range | |
| | 1616 | Medic support released from range | |
| | 1620 | Request range closure—mission complete | Requested range closed |
| | 1625 | Range closed—range and beacon secured | Range closed |

ASSESS

4-91. The assessment phase in this chapter refers to the unit conducting range operations and for the headquarters of the Soldiers trained. Leaders conduct AARs with each firing Soldier during the individual weapon training as part of the training audience's TLP. AARs help Soldiers to identify deficiencies during the training and how the Soldier will correct them. They are also used to reinforce the Soldiers successful behavior.

4-92. During and after training, commanders review the tasks trained, assess the unit's training level in respect to the objectives, and obtain lessons learned to improve the training and unit's proficiency. Commanders record these assessments in DTMS for future use in other training events or to include them in unit SOPs.

4-93. Leaders conduct on-site, informal AARs during training, where training occurs to correct deficiencies in observed task execution. Trainers objectively measure unit training against published Army standards (found in the training and evaluation outlines). Leaders assess training by continuously checking progress toward task achievement or training objectives.

AFTER ACTION REVIEW

4-94. An AAR includes a facilitator, event participants, and other observers. It is an event used to analyze an organization's performance, during and at the conclusion of a training event or operation. The goal of an AAR is to improve a unit's future performance. Using the AAR as a structured review process allows training participants to discover for themselves what happened, why it happened, and how they can perform the task better.

4-95. Once training is complete, the unit conducts the initial tasks of recovering from training operations. It represents the first steps in analyzing training records from the event to develop future training requirements. Units are required to provide their live-fire results in roll up format to the next higher headquarters for review and analysis.

ANALYZE TRAINING RESULTS

4-96. The analysis of the live-fire training event is critical to the unit's success. It provides detailed analysis to the commander about the live-fire results for the unit. The MMT analyzes the engagements and scores to identify possible training gaps and determines potential corrective training to increase the training unit's lethality and skill.

REVIEW TRAINING AMMUNITION EXPENDITURES

4-97. During the analysis, the MMT and ammunition NCO must determine the ammunition expended versus drawn, develop a plan for turn-in and reforecast the ammunition, as needed. This analysis is the first step in

planning the next live-fire training event. Unit closes out any active or open DA Form 581, as required. Unit must reconcile all ammunition expenditures and ensure all remaining live ammunition and dunnage are turned in as per regulation and unit or installation policy.

IDENTIFY INDIVIDUAL EXCELLENCE

4-98. The analysis identifies excellence in the unit. The MMT and NCOIC assist the unit leadership to determine and prepare awards for certifications, qualifications, or exceptional performance, as appropriate. The analysis will indicate exceptional performers to leadership who can recommend these Soldiers for attendance at advanced marksmanship courses. The MMT and range OIC prepare the required memorandum, letter, roster, or locally devised form for Soldiers receiving basic marksmanship qualification badges and associated bars (or clasps) for the battalion commander's signature (see AR 600-8-22).

This page intentionally left blank.

Appendix A

Ammunition

Ammunition is identified by markings, symbols, color-coding, and tactile markings on the items themselves, the containers, and the packing boxes. The markings and standard nomenclature of each item are visual references that completely identify each item. This appendix provides the general information concerning ammunition markings, colors, stamping, and other identifying features common for small- and medium-caliber munitions.

AMMUNITION IDENTIFICATION METHODS

A-1. Training and service ammunition as well as their packaging containers have various markings, symbols, color-coding, and other identifying items applied for identification purposes. These identifying elements provide information about the munition's use, purpose, type, and manufacturing data, according to MIL-STD 1168C, and MIL-STD 709D, respectively.

- Markings and symbols. Painted or stamped on packaging containers, ammunition cans, crates, boxes.
- Lot numbers. Information concerning the manufacturer, date of production, and key production information of the munition.
- Logistic identification codes. Various logistical identification methods that ensure the appropriate munition is provided for the weapon or system, including:
 - Department of Defense Ammunition Code (known as DODAC).
 - Federal Supply Class (known as FSC).
 - DODIC.
 - National stock number (NSN).
- Color codes. Specific color(s) applied to the projectiles to enable rapid identification of the type and primary use of the munition.
- Tactile markings. Imprinted or stamped markings that permit identification of certain munition types visually and through touch.

A-2. The markings, symbols, color codes, and tactile markings that are stenciled, stamped, or painted on munitions or their containers include all the information needed for complete identification. Leaders must be fluent deciphering these markings and symbols to ensure the proper munitions are used for the appropriate task, during training and combat. The following sections provide general information on the various identification features of military munitions used in training and combat. Only relevant information to the unit, leader, or firer is provided. See the appropriate references listed for additional information on ammunition identification.

MARKINGS AND SYMBOLS

A-3. Packaging and containers for small- and some medium-caliber ammunition are clearly marked with standard North Atlantic Treaty Organization (NATO) symbols identifying the contents of the package by NATO compatibility, ammunition type, and packaging information (see figure A-1 through A-3, on pages A-2 through A-3.)



| Marking Type | Symbol | Meaning / Remarks |
|---|---|--|
| North Atlantic Treaty Organization (NATO) General Information |  | NATO standard (Used only on ball, tracer, armor piercing rounds) |
| |  | Interchangeability = suitable for use with same-caliber NATO weapons |

Figure A-1. North Atlantic Treaty Organization compatibility markings example









| Marking Type | Symbol | Meaning / Remarks |
|-----------------|---|--|
| Ammunition Type |  | Blank ammunition |
| |  | Frangible ammunition (cartridge, non-metallic bullet, short-range munitions) |
| |  | Ball ammunition |
| |  | Armor piercing ammunition (AP) |
| |  | Incendiary ammunition |
| |  | Armor piercing incendiary ammunition (API) |
| |  | Tracer ammunition (-T) |
| |  | Armor piercing with tracer ammunition (AP-T) |
| |  | Armor piercing incendiary with tracer (API-T) |

Figure A-2. Small- and medium-caliber ammunition type markings example

A-4. For training unique munitions, the explosive or hazardous elements have been removed to provide the form and fit of the munition during live-fire training events, without any dud-producing hazards consistent with the service round they replicate. For training unique munitions, the components in which all explosive, incendiary, or toxic materials have been simulated by substitution of inert material are identified by impressed inert markings. Components in which all explosive, incendiary, or toxic materials have been omitted are identified by stamped empty markings.





| Marking Type | Symbol | Meaning / Remarks |
|--------------------------------|---|--|
| Link, Belt, and Packaging Type |  | Linked ammunition (using disintegrating links) |
| |  | Linked ammunition (using non-disintegrating links or belts) |
| |  | Ammunition packed in bandoliers |
| |  | Clipped ammunition (typically for single-cartridge small arms with a speed-loading attachment) |

Figure A-3. Packaging markings example

AMMUNITION LOT NUMBERS

A-5. Each item of ammunition is assigned a complete round or item lot number when it is manufactured or when it is at the load, assemble, and packaging plant. The lot numbers are used by manufacturers for quality control. The lot numbers identify the manufacturer, month and year of manufacture, and information specific to the design, development, or production of the ammunition. See MIL-STD 1168C for a description of the current Department of Defense ammunition lot number standards. Figure A-4, on page A-4, describes a typical ammunition lot number, and the types of information provided by each character position that create the lot number.

| Character Position | | | | | | | | | | | | | | | |
|---|----------|--------------|----------|------------------------------------|----------|----------|----------|----------|----------|----------|----------|----------|----------|----------|----------|
| 1 | 2 | 3 | 4 | 5 | 6 | 7 | 8 | 9 | 10 | 11 | 12 | 13 | 14 | 15 | 16 |
| A | M | C | 7 | 5 | D | 0 | 1 | 8 | - | 1 | 2 | 4 | M | G | T |
| MIC | | | YY | | M | INTFX | | | LIC | SEQ | | | SFX | | TH |
| <i>Note:</i> Abbreviations listed are used only for reference within this publication. They are not part of the military standard (MIL-STD) 1168C guidelines. | | | | | | | | | | | | | | | |
| Position | | Abbreviation | | Code Description | | | | | | | | | | | |
| 1-3 | | MIC | | Manufacturer's Identification Code | | | | | | | | | | | |
| 4-5 | | YY | | Year of Production Code | | | | | | | | | | | |
| 6 | | M | | Month of Production Code | | | | | | | | | | | |
| 7-9 | | INTFX | | Lot Interfix Number | | | | | | | | | | | |
| 10 | | LIC | | Lot Identifier Code | | | | | | | | | | | |
| 11-13 | | SEQ | | Lot Sequence Number | | | | | | | | | | | |
| 14, or 14-15 | | SFX | | Ammunition Lot Suffix | | | | | | | | | | | |
| 15 or 16 | | TH | | Theater Indicator Code | | | | | | | | | | | |

Figure A-4. Lot number example

A-6. Each lot number consists of a minimum of 13 characters (positions), and no more than 16 characters. Each character or position is grouped into specific information concerning the munition's manufacturing. The following information is contained in ammunition lot numbers:

- Manufacturer's identification code (known as MIC).
- Year of production (known as YY).
- Month of production (known as M).
- Lot interfix number (known as INTFX).
- Lot identifier code (known as LIC).
- Sequence number (known as SEQ).
- Ammunition lot suffix (known as SFX).
- Theater code (known as TH).

A-7. Each of these components of an ammunition lot number are described in the following figures for reference (see figure A-5). Only the information pertinent to a unit, leader, or firer is provided for simplicity and clarity. See MIL-STD-1168C for additional information concerning the standards for ammunition lot numbers.

| Character Position | | | | | | | | | | | | | | | |
|--------------------|----------|----------|----------|----------|----------|----------|----------|----------|----------|----------|----------|----------|----------|----------|----------|
| 1 | 2 | 3 | 4 | 5 | 6 | 7 | 8 | 9 | 10 | 11 | 12 | 13 | 14 | 15 | 16 |
| A | M | C | 7 | 5 | D | 0 | 1 | 8 | - | 1 | 2 | 4 | M | G | T |
| MIC | | | YY | | M | INTFX | | | LIC | SEQ | | | SFX | | TH |

MIC - Manufacturer's Identification Code
3 letters or characters representing production facility.

YY - Year of Production
Last 2 digits of the year the lot initiated production.

M - Month of Production
Single letter representing the month the lot initiated production:
A - January
B - February
C - March
D - April
E - May
F - June
G - July
H - August
J - September
K - October
L - November
M - December
Note: "I" not used

INTFX - Interfix Number
Three digits, 001 - 999

LIC - Lot Identifier Code
Letter to identify specific lot types:
Default hyphen (-) when not LIC is used.
A - First Article
C - Calibration Lot
E - Experimental Lot
G - Regrouped Lot
H - Hybrid Lot
L - Functional Lot
R - Reference Lot
S - Special Lot

SEQ - Lot Sequence Number
Three digits, 001 - 999

SFX - Suffix Code
1 or 2 letter code: A-ZZ
Indicates changes in lot configuration due to rework, repair, modification, or overhaul.
MAY NOT INCLUDE:
E, I, O, T, W, X, or Y
Excepted letters will not be used in either the first or second letter place.

TH - Ammunition Theater Indicator Code
Placed in either the 15th or 16th position.
In no or a single SFX - TH placed in the 15th position. If double SFX, TH code is placed in the 16th position.
Theater indicator letters are coordinated jointly by all services.
Y, W, and T - previously used for Southwest Asia (SWA).
All TH are excluded from use in SFXC codes.

Note: Abbreviations listed are used only for reference within this publication. They are not part of the military standard (MIL-STD) 1168C guidelines.

Figure A-5. Lot number character position reference card

A-8. The MIC (also called the manufacturer’s identification code) identifies the primary manufacturer of the round. It does not include subcontractors who have been tasked to supply subcomponents of the ammunition. For a complete listing of the MIC’s for all manufacturer’s symbols or codes, see military handbook (known as MIL HDBK)-1461A. Figure A-6 shows an example of the manufacturer’s identification code.

| Character Position | | | | | | | | | | | | | | | |
|---|----------|--------------|----------|------------------------------------|----------|----------|----------|----------|----------|----------|----------|----------|----------|----------|----------|
| 1 | 2 | 3 | 4 | 5 | 6 | 7 | 8 | 9 | 10 | 11 | 12 | 13 | 14 | 15 | 16 |
| A | M | C | 7 | 5 | D | 0 | 1 | 8 | - | 1 | 2 | 4 | M | G | T |
| MIC | | | YY | M | INTFX | | | LIC | SEQ | | | SFX | TH | | |
| <p><i>Note:</i> Abbreviations listed are used only for reference within this publication. They are not part of the military standard (MIL-STD) 1168C guidelines.</p> | | | | | | | | | | | | | | | |
| Position | | Abbreviation | | Code Description | | | | | | | | | | | |
| 1-3 | | MIC | | Manufacturer’s Identification Code | | | | | | | | | | | |
| <p>Manufacturer’s Identification Code (MIC): The MIC or the manufacturer’s identification symbol, is used to identify the manufacturing activity (such as the arsenal, plant, depot, station, or contractor) which manufactured, assembled, loaded, or regrouped the specific lot of ammunition.</p> <p>It does not include subcontractors who have been tasked to <i>supply</i> subcomponents of the ammunition.</p> <p>The MIC is three (3) capital letters or characters. In the event one or two characters are used, the remaining positions are filled in with a hyphen (-), such as A-, or AZ-.</p> <p>For a complete listing of the MIC’s for all manufacturer’s symbols or codes, see military handbook (MIL HDBK)-1461A.</p> | | | | | | | | | | | | | | | |

Figure A-6. Lot number manufacturer’s identification code example

A-9. The year portion of the lot number is identified as a two-digit number representing the production year. The numbers in the fourth and fifth position, of figure A-7 indicate the ammunition was produced in the year 1975.

| Character Position | | | | | | | | | | | | | | | |
|---|---|--------------|----|---|-------------------------|-------|---|---|-----|-----|----|----|-----|----|----|
| 1 | 2 | 3 | 4 | 5 | 6 | 7 | 8 | 9 | 10 | 11 | 12 | 13 | 14 | 15 | 16 |
| A | M | C | 7 | 5 | D | 0 | 1 | 8 | - | 1 | 2 | 4 | M | G | T |
| MIC | | | YY | | M | INTFX | | | LIC | SEQ | | | SFX | | TH |
| <p><i>Note:</i> Abbreviations listed are used only for reference within this publication. They are not part of the military standard (MIL-STD) 1168C guidelines.</p> | | | | | | | | | | | | | | | |
| Position | | Abbreviation | | | Code Description | | | | | | | | | | |
| 4-5 | | YY | | | Year of Production Code | | | | | | | | | | |
| <p>Year of Production (YY): Each ammunition lot includes the year of production inserted after the manufacturer's identification symbol. The year of production is a two (2) digit code represented by the last two (2) numbers of the year that the manufacture, assembly, or regrouping if the lot was <i>initiated</i>.</p> <p>Once initiated, the lot number retains the same year code until the lot is complete.</p> <p>There are no spaces between the manufacturer's identification symbol, the year of production code, and the alpha code used to identify the month of production.</p> | | | | | | | | | | | | | | | |

Figure A-7. Lot number year of production example

A-10. The month of production is a single letter identifying the month of production at the manufacturing facility where the lot was initiated. The letter "I" is not used in the coding system, which reduces confusion with the number "1." The letter "D" in the sixth position indicates the ammunition depicted in figure A-8 was produced in April. The letter codes used are shown in figure A-8, on page A-8.

| Character Position | | | | | | | | | | | | | | | |
|--|----------|--------------|----|---|--------------------------|-------|-----------|---|-----|-----|----|----|-----|----|----|
| 1 | 2 | 3 | 4 | 5 | 6 | 7 | 8 | 9 | 10 | 11 | 12 | 13 | 14 | 15 | 16 |
| A | M | C | 7 | 5 | D | 0 | 1 | 8 | - | 1 | 2 | 4 | M | G | T |
| MIC | | | YY | | M | INTFX | | | LIC | SEQ | | | SFX | | TH |
| <p><i>Note:</i> Abbreviations listed are used only for reference within this publication. They are not part of the military standard (MIL-STD) 1168C guidelines.</p> | | | | | | | | | | | | | | | |
| Position | | Abbreviation | | | Code Description | | | | | | | | | | |
| 6 | | M | | | Month of Production Code | | | | | | | | | | |
| <p>Month of Production (M): Each ammunition lot includes the month of production inserted after the year of production code. The month of production is a single alpha code represented by the month of the year that the manufacture, assembly, or regrouping if the lot was <i>initiated</i>.</p> | | | | | | | | | | | | | | | |
| A | January | | | | | G | July | | | | | | | | |
| B | February | | | | | H | August | | | | | | | | |
| C | March | | | | | J | September | | | | | | | | |
| D | April | | | | | K | October | | | | | | | | |
| E | May | | | | | L | November | | | | | | | | |
| F | June | | | | | M | December | | | | | | | | |
| <p>Note: The letter "I" is not used to eliminate the possibility of confusion with the number 1.</p> <p>Once initiated, the lot number retains the same year code until the lot is complete.</p> <p>There are no spaces between the year of production code, and the alpha code used to identify the month of production, and the lot interfix number.</p> | | | | | | | | | | | | | | | |

Figure A-8. Lot number month of production example

A-11. The seventh, eighth, and ninth position are reserved for the interfix number. The interfix number represents one of four indications—more than a 30 day break in production, a new contract for the ammunition has been issued, a change in design of the round has occurred, or the sequence number has been exhausted. Figure A-9 provides an example interfix.

| Character Position | | | | | | | | | | | | | | | |
|--|---|--------------|----|---|---|---------------------|---|---|-----|-----|----|----|-----|----|----|
| 1 | 2 | 3 | 4 | 5 | 6 | 7 | 8 | 9 | 10 | 11 | 12 | 13 | 14 | 15 | 16 |
| A | M | C | 7 | 5 | D | 0 | 1 | 8 | - | 1 | 2 | 4 | M | G | T |
| MIC | | | YY | | M | INTFX | | | LIC | SEQ | | | SFX | | TH |
| <p><i>Note:</i> Abbreviations listed are used only for reference within this publication. They are not part of the military standard (MIL-STD) 1168C guidelines.</p> | | | | | | | | | | | | | | | |
| Position | | Abbreviation | | | | Code Description | | | | | | | | | |
| 7-9 | | INTFX | | | | Lot Interfix Number | | | | | | | | | |
| <p>Lot Interfix Number (INTFX): Each ammunition lot number commencing with the first lot produced or assembled will have an interfix number consisting of the three (3) digits. The interfix number will usually start with “001”, and continue through “999”.</p> <p>Lot interfix numbers are used to maintain traceability of any significant changes during production. Incremental progression to the interfix number are instigated by either administrative or technical (manufacturing and configuration) changes. See MIL-STD 1168C for additional information.</p> <p>Note: The interfix number “000” is reserved for experimental and reference lots only.</p> | | | | | | | | | | | | | | | |

Figure A-9. Lot number lot interfix number example

A-12. The 10th position is reserved for the lot identifier code. When required, a letter is used in the 10th position, located between the interfix and sequence number (see figure A-10). Each letter has a specific meaning. The 10th position is an indicator that the ammunition has special attributes. When no special attributes exist, the default “-,” or normal lot indicator, is applied.

| Character Position | | | | | | | | | | | | | | | |
|---|---|--------------------------|----|---|---------------------|-------|---|---|-----|-----|----|----|-----|----|----|
| 1 | 2 | 3 | 4 | 5 | 6 | 7 | 8 | 9 | 10 | 11 | 12 | 13 | 14 | 15 | 16 |
| A | M | C | 7 | 5 | D | 0 | 1 | 8 | - | 1 | 2 | 4 | M | G | T |
| MIC | | | YY | | M | INTFX | | | LIC | SEQ | | | SFX | | TH |
| <i>Note:</i> Abbreviations listed are used only for reference within this publication. They are not part of the military standard (MIL-STD) 1168C guidelines. | | | | | | | | | | | | | | | |
| Position | | Abbreviation | | | Code Description | | | | | | | | | | |
| 10 | | LIC | | | Lot Identifier Code | | | | | | | | | | |
| Lot Identifier Code (LIC): A capital letter inserted in the ammunition lot number by replacing the hyphen in the ammunition lot number’s tenth position with the appropriate alpha code. The list below includes those lots that require special marking identification in the lot number for proper handling of the ammunition. | | | | | | | | | | | | | | | |
| Lot Identifier Code | | Type of Non-Standard Lot | | | | | | | | | | | | | |
| - | | Standard Lot | | | | | | | | | | | | | |
| A | | First Article | | | | | | | | | | | | | |
| C | | Calibration Lot | | | | | | | | | | | | | |
| E | | Experimental Lot | | | | | | | | | | | | | |
| G | | Regrouped Lot | | | | | | | | | | | | | |
| H | | Hybrid Lot | | | | | | | | | | | | | |
| L | | Functional Lot | | | | | | | | | | | | | |
| R | | Reference Lot | | | | | | | | | | | | | |
| S | | Special Lot | | | | | | | | | | | | | |
| <i>Note:</i> For detailed information on non-standard lot identifiers, see MIL-STD 1168C. | | | | | | | | | | | | | | | |

Figure A-10. Lot number lot identifier code example

A-13. The 11th, 12th, and 13th positions are used for the lot sequence number (see figure A-11). The lot sequence number identifies the “production run” of rounds produced. Typically, there are lots or batches of 5,000 to 25,000 rounds produced for large caliber ammunition or 100,000 rounds (or more) for small and medium caliber rounds. The number of rounds produced in each batch is established by the manufacturer. Each sequence number identifies the batch of ammunition produced based on the previous conditions of the overall lot number. When the sequence number reaches 999, the interfix number will increase, resetting the sequence number to 001.

| Character Position | | | | | | | | | | | | | | | |
|---|---|--------------|----|---|---------------------|-------|---|---|-----|-----|----|----|-----|----|----|
| 1 | 2 | 3 | 4 | 5 | 6 | 7 | 8 | 9 | 10 | 11 | 12 | 13 | 14 | 15 | 16 |
| A | M | C | 7 | 5 | D | 0 | 1 | 8 | - | 1 | 2 | 4 | M | G | T |
| MIC | | | YY | | M | INTFX | | | LIC | SEQ | | | SFX | | TH |
| <p><i>Note:</i> Abbreviations listed are used only for reference within this publication. They are not part of the military standard (MIL-STD) 1168C guidelines.</p> | | | | | | | | | | | | | | | |
| Position | | Abbreviation | | | Code Description | | | | | | | | | | |
| 11-13 | | SEQ | | | Lot Sequence Number | | | | | | | | | | |
| <p>Lot Sequence Number (SEQ): Three (3) digit lot sequence number identifies a lot according to the sequence of production within each lot interfix number. A sequence number is assigned to each lot produced regardless of the final disposition of the ammunition lot.</p> <p>The lot sequence number within each interfix will start with “001”, and continue through “999”. If the lot sequence increases beyond “999”, the lot interfix number must increase and the lot sequence number must increase, and the lot sequence number resets at “001”.</p> <p>Note: All lot numbers must contain a minimum of 13 characters (manufacturer, date and lot information).</p> | | | | | | | | | | | | | | | |

Figure A-11. Lot number lot sequence number example

A-14. The lot suffix code is an alpha character added to the sequence portion of the ammunition lot number denotes a rework effecting a material change in the original lot or to identify reprocessed propellant lots. Ammunition lot suffixes are always in capital letters and are applied sequentially starting with “A” and continuing through “Z” placed in the 14th and 15th position of the lot number (see figure A-12).

| Character Position | | | | | | | | | | | | | | | |
|---|--|----|------------------|---|-------|---|---|-----|-----|----|----|-----|----|----|----|
| 1 | 2 | 3 | 4 | 5 | 6 | 7 | 8 | 9 | 10 | 11 | 12 | 13 | 14 | 15 | 16 |
| A | M | C | 7 | 5 | D | 0 | 1 | 8 | - | 1 | 2 | 4 | M | G | T |
| MIC | | YY | | M | INTFX | | | LIC | SEQ | | | SFX | | TH | |
| <p><i>Note:</i> Abbreviations listed are used only for reference within this publication. They are not part of the military standard (MIL-STD) 1168C guidelines.</p> | | | | | | | | | | | | | | | |
| Position | Abbreviation | | Code Description | | | | | | | | | | | | |
| 14 or 14-15 | SFX | | Lot Suffix Code | | | | | | | | | | | | |
| <p>Lot Suffix Code (SFX): The suffix is a one (1) or two (2) capitalized character code that usually progresses sequentially. Lot suffix codes identify ammunition that is being reworked, modified, overhauled, etc. They are assigned in alphabetical sequence starting with the letter “A” and continuing through “ZZ”, as necessary.</p> <p>When reworking any items of ammunition at a manufacturing activity or sustainment activity, where the application of an ammunition lot suffix is required, the following letters may not be used in the Lot Suffix Code:</p> | | | | | | | | | | | | | | | |
| Restricted Character | Remarks with no exceptions. | | | | | | | | | | | | | | |
| E | The “E” is reserved for the Lot Identifier Codes for experimental rounds. | | | | | | | | | | | | | | |
| I | Easily confused with the number one (1). | | | | | | | | | | | | | | |
| O | Easily confused with the number zero (0). | | | | | | | | | | | | | | |
| X | Used by the Department of Defense for experimental equipment or munitions. | | | | | | | | | | | | | | |
| Y, W, T | Can be confused with the ammunition theater indicator codes. | | | | | | | | | | | | | | |

Figure A-12. Lot number lot suffix code example

A-15. The lot theater indicator code identifies munitions that were exposed to combat conditions and environments. They provide a means of tracking which lots were sent to which theaters. The lot theater indicators are normally applied by the using military service prior to returning from theater. The lot theater indicator code is placed in the 15th position when not used for the suffix, and placed in the 16th position when the 15th position is in use for the suffix (see figure A-13).

| Character Position | | | | | | | | | | | | | | | |
|--|--------------|----|---------------------------------------|---|-------|---|---|-----|-----|----|----|-----|----|----|----|
| 1 | 2 | 3 | 4 | 5 | 6 | 7 | 8 | 9 | 10 | 11 | 12 | 13 | 14 | 15 | 16 |
| A | M | C | 7 | 5 | D | 0 | 1 | 8 | - | 1 | 2 | 4 | M | G | T |
| MIC | | YY | | M | INTFX | | | LIC | SEQ | | | SFX | | TH | |
| <p><i>Note:</i> Abbreviations listed are used only for reference within this publication. They are not part of the military standard (MIL-STD) 1168C guidelines.</p> | | | | | | | | | | | | | | | |
| Position | Abbreviation | | Code Description | | | | | | | | | | | | |
| 15 or 16 | TH | | Ammunition Lot Theater Indicator Code | | | | | | | | | | | | |
| <p>Ammunition Lot Theater Indicator Code (TH): The Lot Theater Indicator Code identifies munitions that were exposed to combat conditions and environments. They provide a means of tracking which lots were sent to which theaters. The lot theater indicators are normally applied by the using military service prior to returning from theater.</p> <p>Previous ammunition lot theater indicators used were Y, W, and T.</p> <p>Theater indicators are placed after the lot suffix at the fifteenth (15th) or sixteenth (16th) position of an ammunition lot number. If no suffix is currently assigned or a single character suffix is present, then the later indicator will be in the fifteenth (15th) position. When no suffix is present, a single hyphen is used as a placeholder in the fourteenth (14th) position, followed by the theater indicator in the fifteenth (15th) position.</p> <p>When a two character suffix is present, the theater indicator is placed in the sixteenth (16th) position.</p> | | | | | | | | | | | | | | | |

Figure A-13. Lot number ammunition lot theater indicators example

LOGISTIC IDENTIFICATION CODES

A-16. For logistics agencies to provide the right munition to the right organization for the firer, munitions include various identification codes. These logistic codes are interconnected to some degree, where one code may contain one or two other codes. The following logistic identification codes facilitate requesting unit order processes, as well as leader and firer identification of the munitions:

- FSC.
- NSN.
- DODIC.
- DODAC.

A-17. The following sections discuss these four basic codes in general terms, as they apply to the unit, leader, and firer.

FEDERAL SUPPLY CLASSIFICATION

A-18. Conventional ammunition falls within FSC code starting with “13.” The FSC code identifies the type of supply as ammunition, depicted by the first two digits of the four digit FSC code; 13XX. Within this group, ammunition is further broken down by two more numbers that identify the general type or family in which the item falls.

A-19. Table A-1 lists the FSC codes for all ammunition types typical to training and combat. These numbers are used frequently when ordering, reporting, stocking, forecasting, issuing, and turning in ammunition at the brigade level and above. Additionally, the FSC is used as part of the national stock number, DODAC, as described later in this appendix. Additionally, the FSC group is used in equipment technical manuals.

Table A-1. Federal supply classification

| Federal Supply Code Group 13 | Ammunition and Explosive Type or Family |
|-------------------------------------|--|
| 1305 | Ammunition less than 30 millimeters (mm) |
| 1310 | Ammunition 30mm through 75mm |
| 1315 | Ammunition 75mm through 125mm |
| 1320 | Ammunition over 125mm |
| 1330 | Grenades |
| 1340 | Rockets and rocket ammunition |
| 1345 | Land mines |
| 1365 | Military chemical agents |
| 1370 | Pyrotechnics |
| 1375 | Demolition materials |

NATIONAL STOCK NUMBER

A-20. Each complete round or item of conventional ammunition or associated explosive component is identified by its own NSN. The basic components of national stock numbers are:

- FSC.
 - Federal Supply Group.
 - Federal Supply Class.
- National codification bureau country code (known as NCB CC).
- Item Number.

A-21. The first four numbers of the NSN contain the FSC code. It is followed by the national item identification number (known as NIIN) that consists of a two-number code identifying the country of manufacture and seven number item identification. See figure A-14 for an example NSN.

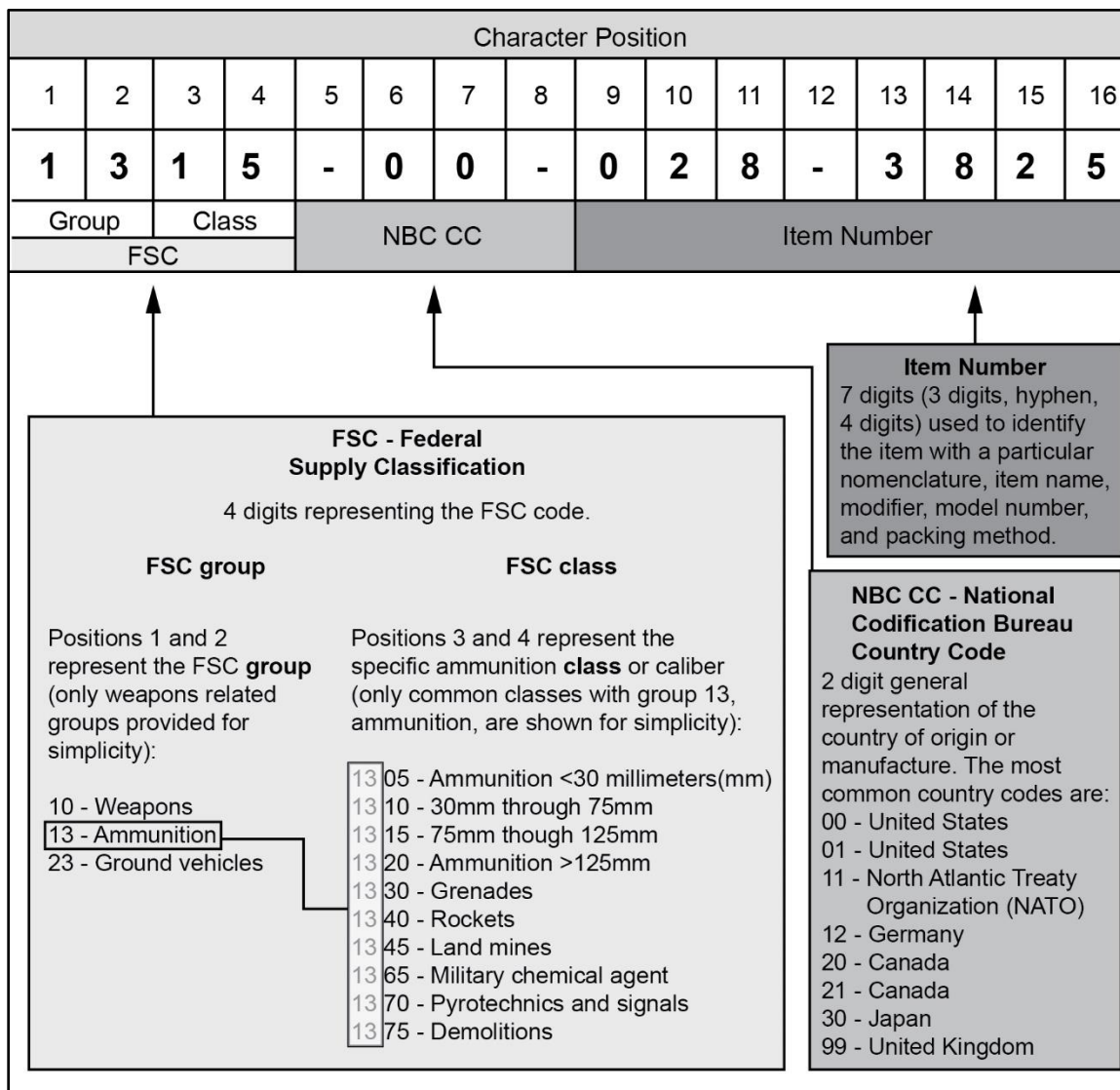

Figure A-14. National stock number reference card

DEPARTMENT OF DEFENSE IDENTIFICATION CODE

A-22. The DODIC is a four digit code that quickly identifies a specific munition by caliber and type. It is used at the unit level to identify the specific cartridge type and configuration used in training and combat by the assigned weapons or systems.

A-23. The FSC code (the first four digits of the NSN) determines the first position (prefix) lettering code for the DODIC. For example, for DODIC A555, the first position character is determined by the munition's FSC, 1305, ammunition less than 30-mm. For newer designed munitions, the second position is also a capital letter. Use of the second position with a letter provides for 2,600 separate munition types per FSC group compared to 1,000 using numbers 0 to 9. Figure A-15, on page A-16, provides a general standard structure of ammunition DODICs.

| Character Position | | | |
|---|------------------------|---|---|
| 1 | 2 | 3 | 4 |
| A | B | 8 | 6 |
| Federal Supply Class (FSC) Group Identifier | Munition Sequence Code | | |

| FSC Group 13 | Ammunition and Explosive Type | FSC Group Identifier | Munitions Sequence Code |
|--------------|--------------------------------|----------------------|--|
| 1305 | Ammunition <30 millimeters(mm) | A | A munition sequence code is a three-digit code represented by the sequence: \$ # #. The \$ is a letter or number (A-Z or 0-9), and # represents a number only (0-9). |
| 1310 | 30mm through 75mm | B | |
| 1315 | 75mm through 125mm | C | |
| 1320 | Ammunition >125mm | D | |
| 1330 | Grenades | G | |
| 1340 | Rockets | H, P, W | |
| 1345 | Land mines | J, K | |
| 1365 | Military chemical agent | K | |
| 1370 | Pyrotechnics and signals | L | |
| 1375 | Demolitions | M | |

Figure A-15. Department of Defense identification code reference card

DEPARTMENT OF DEFENSE AMMUNITION CODE

A-24. DODAC is used by the Department of Defense for logistics management of ammunition. It includes the munition's FSC and its assigned DODIC. The code is used on all using unit DA Form 581s, DA Form 3151-Rs (*Ammunition Stores Slip*), and most ammunition reports. (See figure A-16). The DODAC is used instead of the DODIC to reduce errors with ammunition transactions when ordering at brigade level and above.

| Character Position | | | | | | | | | | | | | | | | | | | | |
|---------------------------------------|---|---|---|---|---|---|---|-------------|----|----|----|----|----|----|----|---|----|----|----|----|
| 1 | 2 | 3 | 4 | 5 | 6 | 7 | 8 | 9 | 10 | 11 | 12 | 13 | 14 | 15 | 16 | 17 | 18 | 19 | 20 | 21 |
| 1 | 3 | 1 | 5 | - | 0 | 0 | - | 0 | 2 | 8 | - | 3 | 8 | 2 | 5 | - | C | 7 | 8 | 5 |
| Federal Supply Classification | | | | National Codification Bureau Country Code | | | | Item Number | | | | | | | | Department of Defense Identification Code | | | | |
| | | | | | | | | | | | | | | | | | | | | |
| Department of Defense Ammunition Code | | | | | | | | | | | | | | | | | | | | |

Figure A-16. Department of defense ammunition code example

COLOR CODING

A-25. Small arms ammunition (less than 20mm) is color-coded according to MIL-STD 709D. Additions to the military standard requirements for small arms ammunition are included in TM 9-1305-201-20&P—

A-26. Collectively, these publications describe the color coding system for small-, medium-, and large-caliber munitions. To best describe the color coding system, the military standard classifies the affected munitions in two distinct tiers—

- Tier I – used for small arms ammunition through caliber .50.
- Tier II – used for ammunition 20 millimeter and above.

A-27. Ammunition color coding may include special band markings for munitions with unique capabilities. Table A-2 and Table A-3 on page A-18 are provided for clarity.

Table A-2. Department of Defense standard ammunition color coding, special band markings





| <i>Department of Defense Standard Ammunition Color Coding (Base Document: MIL-STD-709D, 19 MAR 2009)</i> | | |
|--|--------------|--|
| <i>Special Band Markings</i> | | |
| <i>Marking</i> | <i>Color</i> | <i>Remarks</i> |
|  Diamonds | White | Flechette ammunition |
|  Diamonds | Yellow | Improved conventional munitions (ICM) |
|  Triangles | Yellow | Mass scatterable mines (FASCAM) |
|  Interrupted/Broken Band | Yellow | Explosive binary munitions (band is 0.5 inch segments separated by 0.5 inch gaps) |
|  Interrupted/Broken Band | Dark Green | Toxic binary chemical agent (band is 0.5 inch segments separated by 0.5 inch gaps) |
|  Double Band | Yellow | Thermally-insulated bombs |
| Legend: HTML - hypertext markup language, MAR - march, MIL-STD - military standard | | |

Table A-3. Department of Defense standard ammunition color coding

| Department of Defense Standard Ammunition Color Coding (Base Document: MIL-STD-709D, 19 MAR 2009) | | | |
|--|-------------------------------|-----------------------|---|
| Color | Federal Standard | HTML Code | Remarks |
| Olive Drab Green | FS 34087 | #6d6a3a | Only significance of color is for camouflage purposes. |
| Yellow | FS 33538 Orange Yellow | #edb402 | Identifies High Explosive (HE) ammunition or indicates the presence of a high explosive. |
| Brown | FS 30117 or FS 30140 | #78553f or #735440 | Identifies low explosive items or components or indicates the presence of a low explosive; such as rocket propellant. |
| Gray | FS 36231 Dark Gull Gray | #71787e | Identifies chemical ammunition containing a toxic chemical, incapacitating, or riot control agent. |
| Light Red | FS 31158 | #b94546 | Identifies incendiary ammunition or indicates the presence of highly flammable material (liquids, jellies, solids), designed to produce damage by fire. |
| Dark Red | FS 31136 Insignia Red | #8f1700 | Identifies a riot control agent filler. |
| Light Green | FS 34558 or FS 34449 | #b6cfa8 or #9db895 | Indicates screening or marking smoke ammunition. |
| Dark Green | FS 34108 Medium Green | #28553e | Identifies a toxic chemical agent filler. |
| Violet | FS 17100 Purple | #652f63 | Identifies an incapacitating agent filler. |
| Black | FS 37038 Black | #232227 | Identifies an armor defeating ammunition or indicates an armor defeating capability. |
| Silver/Aluminum | FS 17178 | #b4bcbe | Identifies countermeasure ammunition (for example- radar echo, leaflets) |
| White | FS 37875 Insignia White | #eff5e7 | Identifies illuminating ammunition or ammunition designed to produce a colored light. |
| Light Blue | FS 35109 Dark Blue | #365873 | Identifies training ammunition. |
| Orange | FS 32246 | #da3b01 | May be used to identify ammunition used for tracking and recovery in tests or in training operations (for example - underwater mines, torpedoes). |
| Bronze/Gold/Brass | FS 17043 | #a69d52 | Identifies completely inert ammunition designed for use in activities such as assembly, testing, handling, drills, and so forth, and not designed to be delivered in a delivery system. |

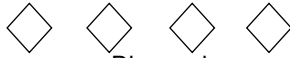
Legend: FS – federal standard, HTML - hypertext markup language, MAR - march, MIL-STD - military standard

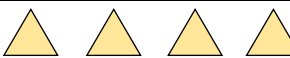
A-28. Table A-4 provides a quick reference for ammunition types or components that are exempt from the military standard color coding requirements. See MIL-STD 709D for additional information.

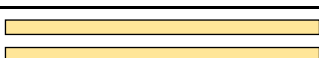
Table A-4. Ammunition color code exemptions

| <i>Ammunition Color Code Exemptions by Tier Classifications</i> | | |
|---|----------------------|----------------------|
| <i>Mission Type or Component</i> | <i>Tier 1</i> | <i>Tier 2</i> |
| Blank | Exempt | Exempt |
| Revolver | Exempt | |
| Proof or high pressure test | Exempt | Exempt |
| Shotgun | Exempt | |
| Cartridge cases | | Exempt |
| Commercial ammunition or explosives | | Exempt |
| Sectionalized or display models | | Exempt |
| Inconspicuous materials or munitions | | Exempt |
| Fuzes | | Exempt |
| Propelling charges | | Exempt |
| Demolition accessories | | Exempt |
| Ammunition components (incomplete munitions) | | Exempt |
| Propellant-actuated devices, ignitors, initiators, detonators | | Exempt |
| Note: For additional information concerning color coding of numbers, see MIL-STD-709D. | | |
| Legend: MIL-STD – military standard | | |

TIER 1 AMMUNITION COLOR CODING

A-29. Tier 1 ammunition is typically marked with color coding on the projectile or subprojectile tip. The bullet tips are painted a distinctive color as a ready means of identification for the user. Figure A-17 describes the general color codes for service small arms ammunition up to and including caliber .50 (Tier 1, Ammunition).















| Color Coding | Projectile | Ammunition Type | Packaging Symbol |
|------------------------|---|--|---|
| No Color |  | BALL |  |
| Black Tip |  | ARMOR PIERCING (AP) |  |
| Silver with Green Tip |  | ARMOR PIERCING, INCENDIARY (API) |  |
| Orange Tip |  | TRACER (T) |  |
| Purple Tip |  | DIM TRACER (T) |  |
| Silver with Orange Tip |  | ARMOR PIERCING, INCENDIARY WITH TRACER (API-T) |  |
| Silver with Purple Tip |  | ARMOR PIERCING, INCENDIARY WITH DIM TRACER (API-T) |  |

Figure A-17. Service small arms color coding with packaging markings example

A-30. Tier 1 munitions include training unique ammunition types. Training unique munitions include those used for training, testing, maintenance, and evaluation. These cartridges are not authorized for use in combat operations. The munitions include the following:

- Blank ammunition.
- Frangible, plastic munitions, and short range munitions do not have a specific color code, although their packaging may be marked with the NATO frangible symbol. Although not required by MIL-STD, most of these munitions have a blue projectile, and are typically referred to as “blue tip.”
- Short range training ammunition (known as SRTA).
- Dummy, drilled, inert (known as DDI). Used for training and weapons function testing.
- Man-marking munitions – Close combat mission capability kit (known as CCMCK).

A-31. Due to the nature of these training unique munitions, most do not follow the MIL-STD 709D guidelines (see color code exceptions). Figure A-18 shows the general colors and markings for these exempted training unique munitions for reference.









| Color Coding | Projectile | Ammunition Type | Packaging Symbol |
|---|---|---|---|
| Rose-petal closure with purple waterproofing |  | BLANK |  |
| Blue Projectile |  | Frangible |  |
| Blue Projectile or Tip |  | Short Range Training Ammunition (SRTA) |  |
| Silver Cartridge (May be drilled or fluted) |  | Dummy, Drilled, Inert (DDI) | |
| Marking Color Integrated into Translucent Tip |  | Close Combat Mission Capability Kit (CCMCK) | |

Figure A-18. Training unique munitions color identification and packaging markings example

TIER 2 AMMUNITION COLOR CODING

A-32. Tier 2 ammunition (20 millimeter and above) is typically marked with color coding on the projectile or subprojectile, as well as colored text that represents any filler or explosive compound for a warhead subcomponent. There are two methods of marking Tier 2 ammunition for identification—projectile color and colored letters, markings, or symbols.

- Projectile color. Indicates whether a filler or composition is present in the projectile or subprojectile, and the primary use of the round.
- Letter, marking, or symbol color. Identifies the type and purpose of a filler, composition, payload, or explosive charge used in projectile or subprojectile. (See figure A-19, on page A-22.)

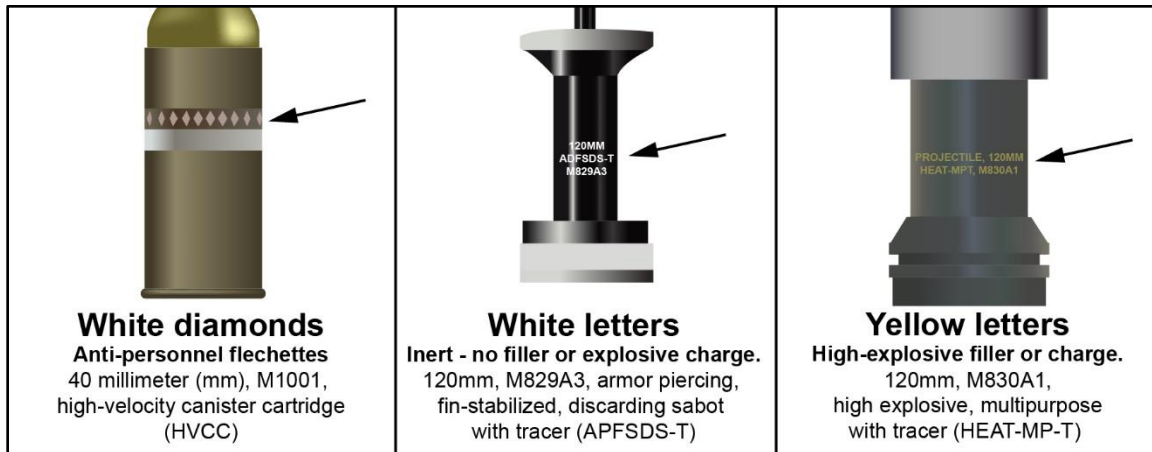

Figure A-19. Tier 2 ammunition letter, marking, or symbol common color standard examples

A-33. Figure A-20 shows the basic Tier 2 ammunition color coding standards. Only the most commonly used standard markings are provided for clarity.

| Use-indicating Color | Meaning / Purpose | Example |
|----------------------|----------------------|---|
| Black | Armor defeating |  120 millimeter (mm), armor-piercing, fin-stabilized, discarding sabot with tracer (APFSDS-T), M829A3 |
| Light green | Smoke, red |  40mm, ground marker, red smoke, M713 |
| Light blue | Target Practice (TP) |  120mm, target practice, multipurpose with tracer (TPMP-T), M1002 |

Figure A-20. Tier 2 ammunition color markings example

AMMUNITION FORECASTING

A-34. Determining the proper area to execute training and identifying ammunition allocations is critical in the preparation for the weapons training density. Potential training areas need to consider safety needs and requirements as well as training needs.

A-35. Units need to plan for increased fire hazards on range complexes and facilities during certain seasons. When doing so, additional planning must include a means to continue live-fire training without tracer ammunition. The unit planners and trainers develop a plan in coordination with the brigade ammunition officer that includes sufficient ball-only ammunition to support their training. This requires “in-lieu-of” ammunition requests that include ammunition types that are traditionally not authorized to units in large quantities.

Note. For example, when the installation's fire hazard increases to "extreme" or "dangerous" due to extremely low precipitation, the installation bans the use of pyrotechnics and tracer ammunition. This is done to prevent uncontrollable or uncontainable fires that will damage the facilities, endanger the environment, and potentially cause harm off the installation.

Delinking tracers from 4:1 mix ammunition is prohibited.

When this occurs, the unit should execute an ammunition contingency plan to rapidly draw comparable ball ammunition to continue training through the firing restriction. This plan must be coordinated in advance with the installation and all documentation for the ammunition draw should be prepared.

A-36. DA PAM 350-38 provides a detailed listing of training ammunition resources authorized to units that support the respective weapon's training strategy. DA PAM 350-38, commonly referred to as STRAC or Standards in Training Commission, is published each fiscal year (FY). It provides the standards for weapons training proficiency which units must train to and achieve in a given FY.

A-37. Planners and trainers determine their training ammunition requirements for their organic assigned weapons, weapon systems, and optics using the tables found in this publication. Planners must be aware that the quantities listed in this training circular represent the requirement, and may not match DA PAM 350-38 exactly, which represent authorizations. From this information, the training event planner in collaboration with the S-3, determine the annual forecast of ammunition required to meet the training goals and objectives of the commander. The planner and the unit ammunition NCO use TAMIS to review, validate, and submit unit ammunition requirements and forecast their training ammunition authorizations by month.

A-38. The Army uses TAMIS to manage training ammunition Army-wide. It provides visibility of all levels of ammunition authorizations, expenditures, and monthly forecasts. Units plan their training events using TAMIS authorizations and submit their monthly forecasts based upon their requirements. Once verified, ammunition stocks required for training will be shipped to the installation within 90 days of the training month.

A-39. Once issued, ammunition items are recorded as expenditures in TAMIS. At the completion of training, unused ammunition will be turned in to the supporting ASP, and the unit's ammunition account will be reconciled. Unit ammunition NCOs or master trainers must ensure any ammunition turned-in is applied to future forecasts for training. Proper management and coordination of ammunition resources are critical to the success of the unit and its live-fire training events.

TOTAL AMMUNITION MANAGEMENT INFORMATION SYSTEM

A-40. The TAMIS is the Department of the Army system for managing operational, training, and test munitions. TAMIS provides the following:

- Calculates training ammunition requirements.
- Calculates combat and sustainment load requirements.
- Prepares training and operational load ammunition forecasts.
- Enables the preparation, validation, and routing of electronic requests for ammunition.
- Collects ammunition expenditures and prepares reports.

A-41. TAMIS is sponsored by the Army G-3 / 5 / 7 munitions management office. Users of TAMIS include:

- Headquarters, Department of the Army.
- Army commands (known as ACOMs), Army service component commands (known as ASCCs), and Direct Reporting Units (known as DRUs) worldwide.
- Army Reserve, and the Army National Guard.
- Department of the Navy.
- Department of the Air Force.
- U.S. Marine Corps.

A-42. Access to TAMIS accounts requires the user to have common access card (CAC) access; however, CAC access is not required to use the training videos on this site.

TRAINING RESOURCE SHORTFALLS

A-43. During initial planning it must be determined if the unit's available ranges and ammunition meet the planning requirements. The master gunner offers solutions to mitigate training resource shortfalls. Some examples include the following:

- The required range may be available at another installation.
- An existing range might be converted to support multiple training requirements.
- A simulation, subcaliber training device, or reduced-scale range might satisfy the need.
- An increase in operational hours of available facilities will meet the shortage.
- Ammunition authorizations from adjacent units may be transferred to support shortfalls.
- Coordination for simulations systems assigned to external units can support increased training demand prior to live-fire execution.

PLANNING CONSIDERATIONS

A-44. This section deals primarily with the special considerations of ammunition transportation to and from a range. The unit ammunition manager must forecast the ammunition requirement for any upcoming ranges, and in turn must coordinate for specific lift assets with the unit S-4. Each unit in the BCT has different procedures for requesting transportation of ammunition; however, it is imperative to understand the rules of ammunition transportation, as well as the lift and transportation capabilities of available assets.

A-45. The fire symbol that applies to the most hazardous material present is posted on or near all explosives locations. It will be visible from all approach roads. One symbol posted on or near the door end of an earth-covered magazine is normally enough. One or more symbols may be needed on other buildings. When all munitions in a storage area are covered by one fire symbol, it may be posted at the entry control point.

- Storage requirement: Placards are placed on entrances to arms rooms, ammunition storage, or issue buildings on range facilities where ammunition is being stored. The appropriate fire division 24-inch sign must be clearly visible when ammunition is present in the structure.
- Transportation requirement: Vehicles transporting ammunition use the 12-inch placard based on the Hazard Classification, as appropriate. Transportation of ammunition and explosives by military vehicles is governed by DA PAM 385-64. All vehicles that are transporting ammunition and explosives must have specific hazardous placards emplaced in a conspicuous position.

A-46. The fire divisions and hazard classifications for stored and transported munitions use the following definitions:

- Fire Division 1, Hazard Class 1.1. Large quantity explosive charges that, when ignited, cause a mass detonation of the adjoining ammunition. Items in this division are field artillery bags propelling charges, demolitions charges, and TNT (2, 4, 6-Trinitrotoluene explosive). There will be few secondary explosions that will be much smaller than the initial detonation.
- Fire Division 2, Hazard Class 1.2. Items configured for storage and transportation that do not mass detonate when a single item or package in a stack is ignited fall within this division. Explosions involving the items result in their burning and exploding progressively with no more than a few at a time reacting. These reactions will project fragments, firebrands, and unexploded items from the explosion site. Blast effects are limited to the immediate vicinity and are not the primary hazard. Typically, main gun ammunition (25mm, 120mm), as well as 40mm with explosive fillers are in this division.

- Fire Division 3, Hazard Class 1.3. Includes items that burn vigorously and cannot usually be extinguished in emergency situations. Explosions normally are confined to pressure ruptures of containers and do not produce propagating shock waves or damaging blast overpressure beyond the magazine distance. The spreading about of burning container materials, propellant, or other flaming debris may cause a severe hazard of spreading fire.
- Fire Division 4, Hazard Class 1.4. Present a fire hazard with minimal blast, fragmentation, or toxic hazards. Small arms ammunition with no incendiary devices fall in this division.

A-47. Units should refer to the Defense Ammunition Center website for the Ammunition Book Complete, called the “Yellow Book,” for a detailed listing of hazard classifications by ammunition DODIC. The link to the Yellow Book is listed in the reference section of this publication. Installation ASP will assist units with identifying the required placards for transportation and storage.

A-48. Figure A-21, on page A-26, describes the ammunition placards based on fire division and hazard class, according to DOD 6055.9-STD. Included are the associated ordering (NSN) information based on location of the placard (building, 24 inch or vehicle, 12 inch, respectively). All placards are designed with orange backgrounds with black lettering.

A-50. All ammunition can be placed on pallets; all pallets are a standard size. However, care must be taken to ensure that when loading a vehicle with ammunition pallets, do not exceed the safe load capacity of the vehicle.

A-51. Periodically, the U.S. Army issues various warnings to units related to ammunition. These notices are often good for only one year, but might be renewed until a problem is fixed or the information is included in more permanent publications. These warnings can take several forms:

- Ammunition information notices (known as AIN) – deal with all types of ammunition.
- Notification of ammunition reclassification – deal with all types of ammunition.
- Safety-of-use messages (known as SOUM) – cover a wide range of topics, which may or may not cover ammunition-specific issues. These vary in topic, but typically relay critical information on the handling and use of the subject item.
- Ground precautionary messages (known as GPM) – cover a wide range of topics, which may or may not cover ammunition-specific issues. These messages are specific to cautions during use.
- Maintenance advisory messages (known as MAM) – cover a wide range of topics, which may or may not cover ammunition-specific issues but are specific to the maintenance aspects of the subject item.

A-52. Additional information is available on the Army Knowledge Online (AKO). In AKO, select Knowledge Network, and then select Abrams Master Gunner Network. A complete listed of SOUM for munitions is on the Sustainable Range Program website, listed in the references section of this manual.

Note. It is the responsibility of the safety officer and ammunition NCO to ensure that ammunition is checked for restrictions and suspensions. It is the OIC's duty to abide by those if any restrictions / suspensions are identified.

For further information regarding suspended or restricted ammunition, see the reference section of this publication. The Defense Ammunition Center website listed in the reference section contains current information, ARMY NAR (needs assessment report) messages with links for each message; an introduction link to explain the Yellow Book and entries; and an automated look-up database that can be searched by DODIC, lot number, or NSN.

A-53. When inspecting small arms ammunition (functional lots), the NSN and lot number are on the plywood box. See figure A-22, on page A-28, for a flow chart for procedures for identifying suspended or restricted lots of ammunitions. Units should be aware that some ammunition is purchased as a “commercial pack” or package, which will not include military containers, markings, or color coding.

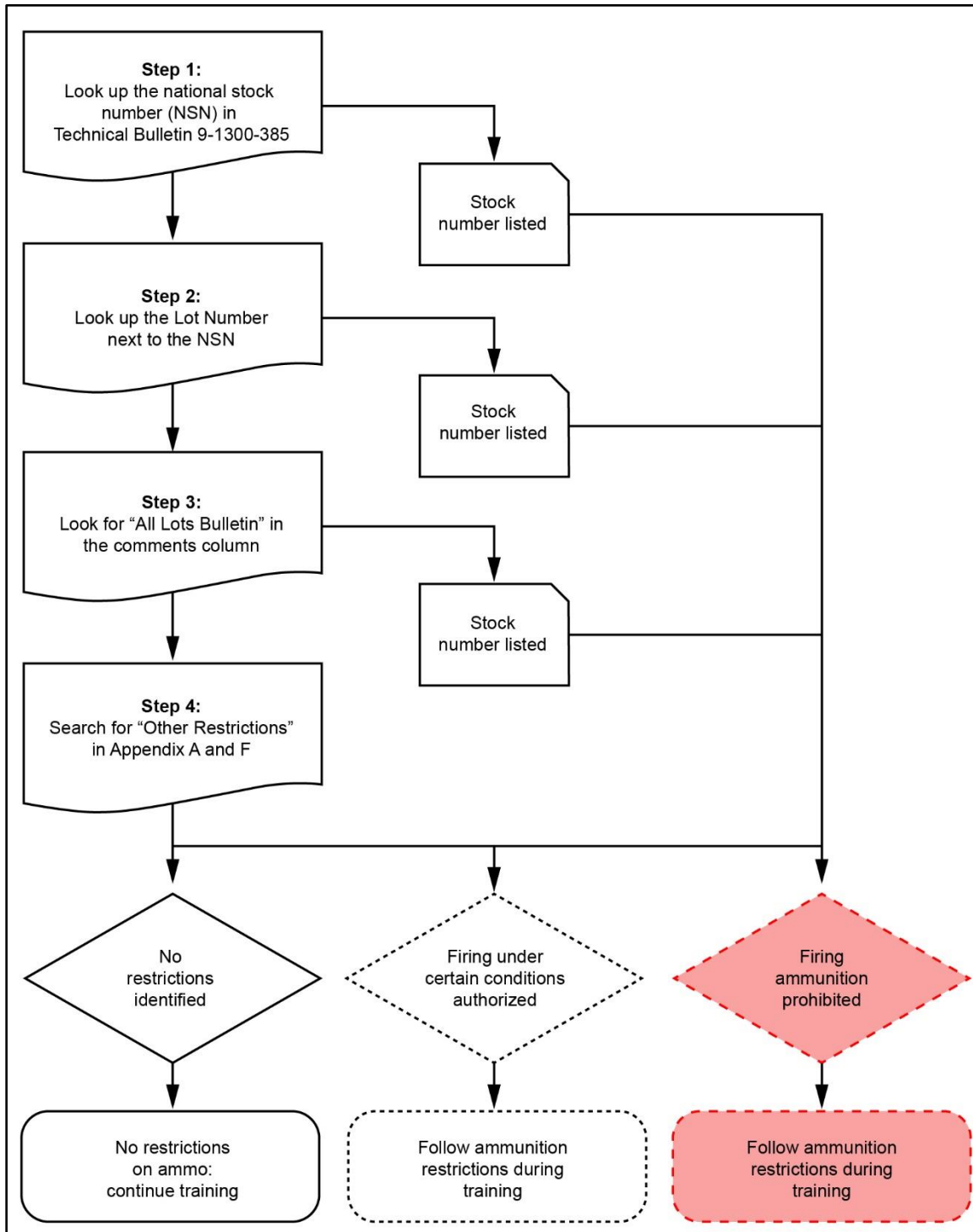

Figure A-22. Identify suspended or restricted ammunition flow chart example

AMMUNITION HANDLING

A-54. According to AR 385-10, Army personnel who handle ammunition and explosives (known as AE), whether by military occupational specialty or additional duty, are required to complete AMMO-45-DL (*Introduction to Ammunition*) and AMMO-68-DL (*Military Munitions Rule*) through the Defense Ammunition Center's website. Both courses are offered online as distance learning courses. AMMO-68-DL requires an annual refresher to remain current. It is also suggested that AE handlers complete the following distance learning courses to better improve their understanding and situational awareness of the hazards associated with AE handling.

- AMMO-31-DL (*Environmental Considerations for Ammunition Personnel*).
- AMMO-63-DL (*U.S. Army Explosive Safety Familiarization*).
- AMMO-78-DL (*Ammunition Publications*).
- AMMO-54-DL (*Risk Management and Preparation of SOP for AE*).
- AMMO-99-DL (*Application of U.S. Army Explosive Safety Quantity Distance (ESQD) Principles*).
- AMMO-107-DL (*Introduction to Explosive Safety Management for Safety Professionals*).
- AMMO-112-DL (*Ammunition and Explosives Storage Safety*).

A-55. All required and suggested courses outlined in AR 385-10 can be accessed through the Defense Ammunition Center's Training website (see reference section).

AMMUNITION SAFETY

A-56. Periodically, the U.S. Army issues various warnings to units related to ammunition. These notices are often good for only one year, but might be renewed until a problem is fixed or the information is included in more permanent publications. When inspecting small arms ammunition (functional lots), the NSN and lot number are on the plywood box. These warnings can take several forms:

- AIN and NAR deal with all types of ammunition. An example of an important AIN for units to read prior to occupation of live-fire ranges is in the reference section of this publication.
- SOUM, GPM, and MAM cover a wide range of topics, which may or may not cover ammunition-specific issues.

Notes. It is the responsibility of the safety officer and ammunition NCO to ensure that ammunition is checked for restrictions and suspensions. It is the OIC's duty to abide by any restrictions and suspensions that are identified.

For further information regarding suspended or restricted ammunition, see reference section of this publication. The Defense Ammunition Center website listed in the reference section contains current information, ARMY NAR messages with links for each message; an introduction link to explain the Yellow Book and entries; and an automated look-up database that can be searched by DODIC, lot number, or NSN.

AMMUNITION ISSUE POINT

A-57. Ammunition issue points (ammo points) are either hard structures or outdoor sites designated for the storage and issue of ammunition. Ammo points require the unit to designate a certified ammunition handler as the ammunition NCO, charged with receiving the ammunition, setting up the ammo point, the safety and efficiency of the ammo point, ensuring the correct DODIC and amount of ammunition are issued to firers, ensuring brass and dunnage from used ammunition is returned and accounted for, tracking consumption of ammunition, and preparing the ammunition and dunnage for turn in at the conclusion of the training event. The unit should assign an ammunition detail to facilitate efficiency at the ammunition point.

A-58. Upon occupying and receiving ammunition, the ammunition NCO ensures the hazard division placards are clearly visible from all sides of the ammo point, and that they reflect the highest rated ammunition type present. The ammunition NCO then checks the lot numbers against TB 9-1300-385.

A-59. Fire and excessive heat are two of the greatest hazards to ammunition. Many ammunition and explosives items are extremely sensitive to heat and react at temperatures substantially lower than those required to ignite ordinary wood, paper, or fabrics. Even indirect heat generated by a fire could initiate a reaction and result in an explosion. Smoking is prohibited within 50 feet of any ammo point.

A-60. A minimum of two fire extinguishers, both rated as class B and class C, suitable for the hazards involved are available for immediate use when ammunition is being handled. Extinguishers need not be permanently located at the site but must be present during the training event. Each extinguisher is placed in a conspicuous and readily accessible location. Each fire extinguisher is kept in a full or fully charged, operable condition.

A-61. Distribution of ammunition to personnel occurs only in areas designated for that purpose; for example, ready lines, firing lines, attack positions, assembly areas, or defilade positions. Blank and live-fire ammunition is not stored in or issued from the same location at the same time.

A-62. DA PAM 385-63 states: The quantity of ammunition unpacked for training will be kept to the minimum quantity needed for live-fire training or an exercise. Packaging material, propelling increments, and fuses will be retained until completion of the live-fire portion of the training or exercise. Units will not burn wooden containers or indiscriminately use or dispose of ammunition to preclude its return to a storage facility. All ammunition, unpacked for use but not used, will be repackaged into its original packing configuration prior to return to the ASP.

A-63. To the maximum extent possible, using units ensure ammunition remains in its original packing or, upon being opened, is repacked per appropriate drawings or specifications, preferably using its original packaging material. This practice is critical to both safety and quality. Ammunition that has misfired or has been classified as unserviceable must be indelibly marked (preferably using DD Form 1575 [*Suspended Tag – Materiel*]) and segregated from serviceable ammunition.

A-64. The ammunition is stacked by L number in stacks and arranged so that air may circulate freely beneath and throughout the stack. When multiple lots are stored, all items or containers of a single lot should be stored together and the line of separation between lots must be clearly indicated with a DA Form 3020–R (*Magazine Data Card*), equivalent marking, or physical separation. Lots of ammunition must never be mixed randomly. The bottom layer should be raised from the floor about three inches.

A-65. Empty containers, excess dunnage, or tools should be permitted to remain at the ammo point only during the period of time required to complete the job for which they are being used. No oily rags, paint, and other flammable materials are present at the ammo point.

UNEXPLODED EXPLOSIVE ORDNANCE HAZARDS

A-66. All soldiers must be able to recognize and react to unexploded explosive ordnance (UXO) hazards. Reactions include avoiding the hazard if possible, securing and marking the site, and reporting the hazard through the chain of command. Under no circumstances should untrained Soldiers approach, disturb, touch, or pick up UXOs, regardless of whether the ordnance is identified as U.S. or enemy. This rule is applicable during peacetime, contingency operations, and in war.

A-67. Reporting UXOs on the battlefield requires timely and accurate information. According to ATP 4-32 the UXO 9-line report format is—

- Line 1: Date/Time group discovered.
- Line 2: Reporting activity and location (grid).
- Line 3: Contact method: radio frequency and call sign or telephone number.
- Line 4: Type of munition (dropped, placed, projected, or thrown).
- Line 5: Chemical, biological, radiological, and nuclear contamination.
- Line 6: Resources threatened.
- Line 7: Impact on mission.
- Line 8: Protective measures taken.
- Line 9: Recommended priority (immediate, indirect, minor, or no threat).

Appendix B

Forms

This appendix is designed for trainers and units to properly fill out all associated forms and scorecards for each table of each weapon covered in this publication. The forms are divided by weapon type and are presented in an alphanumeric sequence. Go to the APD website found in the reference section at the back of this manual for downloadable / printable copies of all of these forms.

WEAPONS TRAINING FORMS

B-1. Table B-1, on page B-2, provides the list of required Department of the Army forms for each individual weapon's training strategy. Units may require multiple copies of forms to complete specific tasks during the event. The forms listed are the minimum forms required to conduct the training as described in this publication. Units may add additional information as needed in the format prescribed by the organization.

B-2. Each form required for individual weapons training are described in alpha-numeric order. For those forms where TC 3-20.40 is the proponent, the instructions for correctly documenting the training on the form are included. Where other publications are the proponent, the appropriate reference is listed.

B-3. Units should refer to the appropriate proponent publication for instructions and additional information concerning the form. Although most forms are self-explanatory, descriptions of the appropriate information used to complete each required block or selection are provided for clarity.

Note. Most simulation systems will create required forms upon completion of the virtual training. Units should have additional hard copies for the lane evaluators to complete in the event printing capability is unavailable.

Table B-1. Individual weapon training required Department of the Army forms

| Training Event | Weapon | | | |
|--|------------------------------|----------------|------------------------------|--|
| | M4 / M16 | M9 / M17 / M18 | M249AR | SNIPER WEAPONS |
| Table I | DA Form 7815 | DA Form 7815 | DA Form 7815 | DA Form 7815 |
| Table II | DA Form 7801 | DA Form 7814 | DA Form 7801 | DA Form 7811 |
| Table III | DA Form 7815 | DA Form 7815 | DA Form 7815 | DA Form 7815 |
| Table IV | | | | DA Form 7636 DA Form 7637 DA Form 7638 DA Form 7651 |
| Table V | DA Form 7801 DA Form 5517 | DA Form 7814 | DA Form 7801 DA Form 5517 | DA Form 7811 DA Form 7636 DA Form 7637 DA Form 7638 DA Form 7651 |
| Table VI | DA Form 7801 DA Form 5517 | DA Form 7814 | DA Form 7801 DA Form 5517 | DA Form 7811 DA Form 7636 DA Form 7637 DA Form 7638 DA Form 7651 |
| Validation | DA Form 7822 | DA Form 7821 | | |
| Urban rifle marksmanship | DA Form 7819 | | DA Form 7819 | |
| Night fire, assisted | DA Form 7489 DA Form 5517 | | DA Form 7489 DA Form 5517 | |
| Legend: M249AR – automatic rifle (LIN: M09009), DA – Department of the Army, LIN – line item number | | | | |

DA FORM 5517, STANDARD RANGE CARD

B-4. This section provides an example of a correctly completed DA Form 5517 (*Standard Range Card*). The Soldier uses the DA Form 5517 (see figure B-1) to create a sketch of the surrounding terrain that is supported by direct fire from one fighting position. (See ATP 3-21.18 for additional information on completing this form.) Go to the APD website found in the references section at the back of this manual for a downloadable / printable copy. This form is one page.

STANDARD RANGE CARD
For use of this form see ATP 3-21.8; the proponent agency is TRADOC.

| | | |
|---------------------|---|---------------------------|
| SQUAD <u>1st</u> | May be used for all types of direct fire weapons. | MAGNETIC NORTH |
| PLATOON <u>1st</u> | | |
| COMPANY <u>A Co</u> | | |

DATA SECTION

| POSITION IDENTIFICATION | | | DATE 14 JUNE 2018 | | |
|-------------------------|--------------------------|-------------------------------------|----------------------|------|----------------|
| WEAPON M240B | | EACH CIRCLE EQUALS METERS 100 | | | |
| NO. | DIRECTION/ DEFLECTION | ELEVATION | RANGE | AMMO | DESCRIPTION |
| 1 | | -50 / 3 | 600 | 7.62 | FPL |
| 2 | R105 | +50 / 40 | 400 | 7.62 | LONE PINE |
| 3 | L235 | 0 / 28 | 250 | 7.62 | TRAIL JUNCTION |
| | | | | | |
| | | | | | |
| | | | | | |

REMARKS:
NO. 1- -4 NO. 3- W15/L7

DA FORM 5517, FEB 2016 PREVIOUS EDITIONS ARE OBSOLETE. APD LC v1.00

Figure B-1. DA Form 5517 (Standard Range Card) example

DA FORM 7636, SNIPER TARGET DATA SHEET MOVING TARGET

B-5. This section provides an example of a DA Form 7636 (*Sniper Target Data Sheet Moving Target*), currently being used by a sniper who has fired four of 10 total shots. The sniper uses the DA Form 7636 (see figure B-2) to capture firing occasion and ballistic information against moving targets. See TC 3-22.10 for additional information on completing this form. Go to the APD website found in the references section at the back of this manual for a downloadable / printable copy. This form is one page.

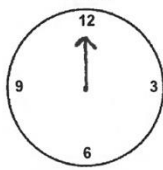
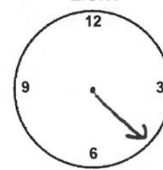
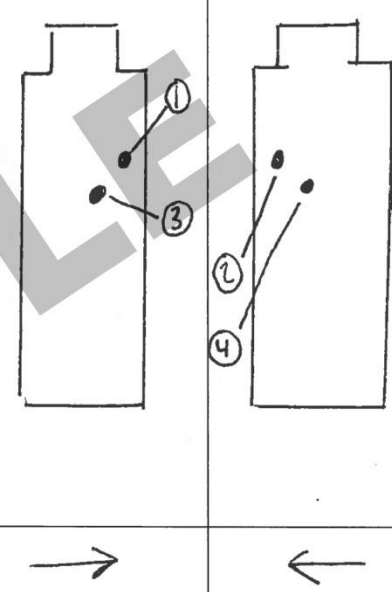
| SNIPER TARGET DATA SHEET MOVING TARGET | | | | | | | | | | |
|---|---------------|---------------------------|-----------------|------|---|-------|---|--------|--------------|--|
| For use of this form, see TC 3-22.10; the proponent agency is TRADOC. | | | | | | | | | | |
| Distance to target <u>300</u> YARDS/METERS | | | | | | | | | | |
| Note: Draw in targets needed. | | | | | | | | | | |
| RANGE | DATE | TIME | RIFLE/SCOPE NO. | AMMO | TEMP | HUMID | LIGHT | MIRAGE | | |
| 10 | 04 April 2017 | 0930 | M2010 | A191 | 70° | 40% | overcast | poor | | |
| WIND  DIRECTION | | WIND 4 MPH VELOCITY | | | LIGHT  DIRECTION | |  | | | |
| | 1 | 3 | 5 | 7 | 9 | | | | | |
| ELEV | .8 | .8 | | | | | | | CORRECT LEAD | |
| WIND | 0 | 0 | | | | | | | | |
| LEAD | 1.2 | 1.1 | | | | | | | | |
| MILS | | | | | | | | | | |
| DIR | | | | | | | | | | |
| | 2 | 4 | 6 | 8 | 10 | | | | | |
| ELEV | .8 | .8 | | | | | | | CORRECT LEAD | |
| WIND | 0 | 0 | | | | | | | | |
| LEAD | 1.2 | 1.1 | | | | | | | | |
| MILS | | | | | | | | | | |
| DIR | | | | | | | | | | |
| REMARKS | | | | | | | | | | |
| <ul style="list-style-type: none"> Target speed in mils (1 second) x TOF (in seconds) = mil hold $3 \times .4 = 1.2$ mil lead Sniper used cm hold, ambush technique, felt rushed on 1st shot Target, etype cut in half. | | | | | | | | | | |

DA FORM 7636, DEC 2017

PREVIOUS EDITION IS OBSOLETE

APD LC v1.00

Figure B-2. DA Form 7636 (Sniper Target Data Sheet Moving Target) example

DA FORM 7637, SNIPER'S RANGE CARD

B-6. This section provides an example of a correctly completed DA Form 7637 (*Sniper's Range Card*). The sniper uses the DA Form 7637 (see figure B-3) to sketch the engagement area with appropriate target referencing information. See TC 3-22.10 for additional information on completing this form. Go to the APD website found in the references section at the back of this manual for a downloadable / printable copy. This form is one page.

| SNIPER'S RANGE CARD | | | | | | | | | | | | | | | | | | | | | |
|--|-----|----------|------------|-------------------|----------|-------------|----------|-------------------|----------|--|----------|-------------|----------|-------------|----------|-------------|----------|-------------|-----------|-------------|----------|
| POSITION IDENTIFICATION A387 | | | | | | | | | | METHOD OF OBTAINING RANGE MIL RELATION | | | | | | | | | | | |
| | | | | | | | | | | | | | | | | | | | | | |
| RANGE | 900 | 800 | 700 | 600 | 500 | 400 | 300 | 200 | 100 | 100 | 200 | 300 | 400 | 500 | 600 | 700 | 800 | 900 | RANGE | | |
| ELEVATION | 722 | 841 | 751 | 6 | 5 | 4 | 3 | 2 | 1 | 1 | 2 | 3 | 4 | 5 | 6 | 7+1 | 8+1 | 9+2 | ELEVATION | | |
| WINDAGE | 5 | 4.5 | 4 | 3.5 | 2.5 | 2 | 1.5 | 1 | ∅ | ∅ | 1 | 1.5 | 2 | 2.5 | 3.5 | 4 | 4.5 | 5 | WINDAGE | | |
| TEMP | | WIND | | TRP 1 | | TRP 2 | | TRP 3 | | TRP 1 | | TRP 2 | | TRP 3 | | TRP 1 | | TRP 2 | | TRP 3 | |
| HIGH | LOW | VELOCITY | DIRECTIONS | AZIMUTH | DISTANCE | AZIMUTH | DISTANCE | AZIMUTH | DISTANCE | AZIMUTH | DISTANCE | AZIMUTH | DISTANCE | AZIMUTH | DISTANCE | AZIMUTH | DISTANCE | AZIMUTH | DISTANCE | AZIMUTH | DISTANCE |
| 75 | 65 | 10 MPH | S/← | 219° | 700m | 272° | 350m | 315° | 650m | | | | | | | | | | | | |
| | | | | DESCRIPTION | | DESCRIPTION | | DESCRIPTION | | DESCRIPTION | | DESCRIPTION | | DESCRIPTION | | DESCRIPTION | | DESCRIPTION | | DESCRIPTION | |
| | | | | ROAD INTERSECTION | | BRIDGE | | ROAD INTERSECTION | | | | | | | | | | | | | |

DA FORM 7637, DEC 2017

PREVIOUS EDITION IS OBSOLETE.

APD LC v1.00

Figure B-3. DA Form 7637 (Sniper's Range Card) example

DA FORM 7638, MILITARY SKETCH PANORAMIC AND TOPOGRAPHIC VIEWS

B-7. This section provides an example of a correctly completed topographic view using a DA Form 7638 (*Military Sketch Panoramic and Topographic Views*). The sniper uses the DA Form 7638 (see figure B-4) to sketch the engagement area, in the topographic view, with appropriate target referencing information. See TC 3-22.10 for additional information on completing this form. Go to the APD website found in the references section at the back of this manual for a downloadable / printable copy. This form is one page.

| MILITARY SKETCH PANORAMIC AND TOPOGRAPHIC VIEWS <small>For use of this form, see TC 3-22.10; the proponent agency is TRADOC.</small> | | | | | | |
|---|-----------------|------------------|------------------|-------------------|--|--------------------------------|
| REMARKS | | PANORAMIC VIEW | | | REMARKS | |
| N/A | | N/A | | | N/A | |
| SKETCH NAME | N/A | | MAGNETIC AZIMUTH | SKETCH NO. N/A OF | NAME | N/A |
| GRID COORD | N/A | | | | RANK | N/A |
| WEATHER | N/A | | | SCALE N/A :: | DATE/TIME | N/A |
| REMARKS | | TOPOGRAPHIC VIEW | | | REMARKS | |
| <p>① Range to BRIDGE is 400m.</p> <p>② Pond is 200m Long.</p> <p>③ BRIDGE is Reinforced Concrete and can hold 2 vehicles side by side.</p> <p>④ ROAD is ASPHALT.</p> <p>⑤ ROAD is 3 FT ABOVE WATER LEVEL WITH SOFT SHOULDERS ON BOTH SIDES.</p> | | | | | <p>⑥ WATER IS NOT POTABLE.</p> <p>⑦ VEGETATION IS SCARCER WITH SOME TREES.</p> <p>⑧ WOODS ON ALL SIDES.</p> <p>⑨ TRP #1 IS Intersection 750M LEFT AT POSITION</p> <p>⑩ TRP #2 IS BRIDGE AT POND 400M AWAY.</p> <p>⑪ TRP #3 IS 500m AT INTERSECTION</p> <p>⑫ ROAD REFERENCE POINT IS A CHURCH</p> | |
| SKETCH NAME | Wetons Pond | | MAGNETIC AZIMUTH | SKETCH NO. 1 OF 1 | NAME | ZANE BLADSHAW |
| GRID COORD | PL 427 648 | | | | RANK | SGT |
| WEATHER | Clear/cool 64°F | | | SCALE 1" = 25' | DATE/TIME | 28 JAN 2015 12:10 HRS LOCAL |

DA FORM 7638, DEC 2017

PREVIOUS EDITION IS OBSOLETE.

APD LC v1.00

Figure B-4. DA Form 7638 (Military Sketch Panoramic and Topographic Views) example

DA FORM 7651, SNIPER TARGET DATA SHEET, STATIONARY TARGET

B-8. This section provides an example of a correctly completed DA Form 7651 (*Sniper Target Data Sheet Stationary Target*). The sniper uses the DA Form 7651 (see figure B-5) to capture firing occasion and ballistic information against moving targets. See TC 3-22.10 for additional information on completing this form. Go to the APD website found in the references section at the back of this manual for a downloadable / printable copy. This form is one page.

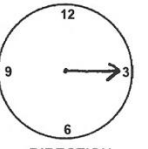
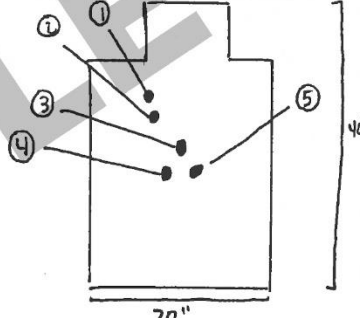
| SNIPER TARGET DATA SHEET STATIONARY TARGET | | | | | | | | | |
|--|---------------|---------------|-----------------|--|------|---|------------------------|---------------------|------------------------|
| For use of this form, see TC 3-22.10; the proponent agency is TRADOC. | | | | | | | | | |
| Distance to target <u>300</u> YARDS/METERS | | | | | | | | | |
| Note: Draw in targets needed. | | | | | | | | | |
| RANGE | DATE | TIME | RIFLE/SCOPE NO. | AMMO | TEMP | HUMID | LIGHT | MIRAGE | |
| 10 | 04 April 2017 | 0900 | M110/00123 | AA11 | 75° | 70% | clear | good | |
| WIND  | | WIND 4 MPH | | LIGHT  | | ELV/USED 1.5 mil | ELV/CORRECT 1.3 mil | WIN/USED .3 left | WIN/CORRECT .2 left |
| | 1 | 2 | 3 | 4 | 5 |  | | | |
| ELEV | 1.5 | 1.5 | 1.3 | 1.3 | 1.3 | | | | |
| WIND | .3L | .3L | .2L | .2L | .2L | | | | |
| CALL | CM | CM | CM | CM | CM | | | | |
| DIST | 300m | 300m | 300m | 300m | 300m | | | | |
| | 6 | 7 | 8 | 9 | 10 | | | | |
| ELEV | | | | | | | | | |
| WIND | | | | | | | | | |
| CALL | | | | | | | | | |
| DIST | | | | | | | | | |
| REMARKS | | | | | | | | | |
| <ul style="list-style-type: none"> • Target (E-type) • light wind, 11 o'clock • Sniper had solid position, felt good. • Could easily spot trace. | | | | | | | | | |

DA FORM 7651, DEC 2017

PREVIOUS EDITION IS OBSOLETE.

APD LC v1.00

Figure B-5. DA Form 7651 (Sniper Target Data Sheet Stationary Target) example

DA FORM 7815, WEAPONS TRAINING ROLL UP

B-9. The trainer uses the DA Form 7815, (*Weapons Training Roll Up*), (see figure B-6, on page B-10) to record the Soldier's performance on either Table I or III for any weapon listed in this manual. Go to the APD website found in the references section at the back of this manual for a downloadable / printable copy. This form is one page.

B-10. The unit uses blocks 1 through 4 to enter administrative information and annotate table number being tested. Block 5 lists the Soldiers involved in the training being conducted. Block 6 lists the task numbers being trained and tested during the training table. Block 7 is used by the unit commander to certify the training has been completed.

- Block 1- The unit or trainer enters the unit name.
- Block 2- The unit or trainer enters the weapon type being trained.
- Block 3- The unit or trainer checks which table of this weapon type is being trained and tested.
- Block 4- The unit or trainer enters the date the training took place (year-month-day).
- Block 5- The unit or trainer enters the names and ranks of the Soldiers present for and conducting the training.
- Block 6- The unit or trainer enters the task numbers associated with the weapon type and table being trained. To the right of the task number, and below the corresponding Soldiers' name, a GO is annotated for a first time GO on a task. If a Soldier receives a NO GO, the box is left blank until they are retrained and reevaluated. The subsequent attempts to pass the task are annotated in the box with a "G" preceding the number of attempts to pass the task. For example, if a Soldier required three attempts before passing a task, they would receive a "G3" in the box corresponding to the task and their name.
- Block 7- The unit commander certifies that the training and testing was completed to standard for all Soldiers listed in Block 5.
- Block 8- The unit commander enters the date they certified the training conducted in Block 6.

| WEAPONS TRAINING ROLL UP | | | | | | | | | | | |
|---|---------------|----------------------|---------------------------|----------------------------|-------------------------------|-------------------------|-------------------------|---|---------------------------|--------------------------------|-----------------------|
| For use of this form, see TC 3-20.40; the proponent agency is TRADOC. | | | | | | | | | | | |
| 1. UNIT A CO. 1-81 IN | | | | 2. WEAPON TYPE M4A1 | | | | 3. TABLE NUMBER (CHECK ONE) TABLE I <input checked="" type="checkbox"/> TABLE III <input type="checkbox"/> | | 4. DATE (YYYYMMDD) 20190802 | |
| 5. SOLDIER (RANK & NAME) | 6. TASK | SFC BROWN, AVA D. | SFC DAVIS, ISABELLA A. | ILT GARCIA, SANTIAGO L. | SGT HERNANDEZ, ISABELLA S. | SGT JOHNSON, EMMA C. | SPC JONES, OLIVIA N. | SPC MARTINEZ, SOFIA C | PFC MILLER, WILLIAM U. | PFC RODRIGUEZ, SEBASTIAN G. | PV2 SMITH, LIAM R. |
| | PMI&E EXAM | GO | GO | GO | GO | GO | G2 | GO | GO | GO | G2 |
| | 071-COM-0028 | GO | GO | GO | GO | GO | GO | GO | GO | GO | GO |
| | 071-COM-0029 | GO | GO | GO | GO | GO | GO | GO | GO | GO | GO |
| | 071-COM-0030 | GO | GO | GO | GO | GO | GO | GO | GO | GO | GO |
| | 071-COM-0031 | GO | GO | GO | GO | GO | GO | GO | GO | GO | GO |
| | 071-COM-0032 | GO | GO | GO | G2 | GO | GO | GO | GO | GO | GO |
| | 071-705-0003 | GO | GO | GO | GO | GO | GO | GO | GO | GO | GO |
| | 0071-705-0011 | GO | GO | GO | GO | GO | GO | GO | GO | GO | GO |
| | 071-705-0013 | GO | GO | GO | GO | GO | GO | GO | GO | GO | GO |
| | 071-705-0015 | GO | GO | GO | GO | GO | GO | GO | GO | GO | GO |
| | AMMUNITION ID | GO | G2 | G2 | GO | G3 | GO | GO | GO | GO | G3 |
| 7. CERTIFYING OFFICIAL SIGNATURE (COMMANDER) Wilson, James Y. 1234567890 | | | | | | | | | | 8. DATE (YYYYMMDD) 20190802 | |

DA FORM 7815, JUL 2019

APD AEM v1.00ES

Figure B-6. Completed DA Form 7815 (Weapons Training Roll Up) example

WEAPONS SCORECARDS

DA FORM 7814, PISTOL SCORECARD

B-11. This section provides instructions to correctly complete DA Form 7814, (*Pistol Scorecard*). The trainer uses the DA Form 7814 (see figure B-7, on page B-12) to record the Soldier's performance on either Table V, Practice, or Table VI, Qualification. Go to the APD website found in the reference section at the back of this publication for a downloadable / printable copy. This form is one page.

B-12. The Soldier or first line leader uses blocks 1 through 8 to enter administrative information. Blocks 9 through 15 are used by the lane safety or designated NCO to score and record firing information. For units with access to an engagement skills trainer (known as EST), blocks 12 through 13 are completed in the simulator. Units without access to an EST will fire the CBRN and Night phases at the range and the trainer will annotate the results in these blocks of DA Form 7814. Blocks 17 and 18 are used by the range OIC to verify the completeness and accuracy of the information on the scorecard. Block 19 is used by the unit commander to certify the qualification status and rating of the firer.

- Block 1- The Soldier or leader enters the firers' name (last name, first name, and middle initial).
- Block 2- The Soldier or leader enters the firers rank.
- Block 3- The Soldier or leader enters the ID code (Department of Defense Identification (DODID) number located on the reverse side of the Soldiers' CAC).
- Block 4- The Soldier or leader enters the date the firing took place (year-month-day).
- Block 5- The Soldier or leader enters the lane and firing order the Soldier fired in.
- Block 6- The Soldier or leader enters the weapon type (M9, M11, or M17 / M18).
- Block 7- The Soldier or leader enters any attached equipment to the weapon.
- Block 8- The Soldier or leader checks the appropriate table box for either practice or qualification.
- Block 9- Lane safeties or designated NCOs, assigned as lane scorers, enter an X on the target block if the Soldier hit the target. The scorer totals the number of hits and annotates the number in the block located at the bottom of the column for Phase I Day, Standing.
- Block 10- Lane safeties or designated NCOs, assigned as lane scorers, enter an X on the target block if the Soldier hit the target. The scorer totals the hits and annotates the number in the block located at the bottom of the column for Phase II Day, Kneeling.
- Block 11- Lane safeties or designated NCOs, assigned as lane scorers, enter an X on the target block if the Soldier hit the target. The scorer totals the hits and annotates the number in the block located at the bottom of the column for Phase III Day, Moving.
- Block 12- Lane safeties or designated NCOs, assigned as lane scorers, enter an X on the target block if the Soldier hit the target. The scorer totals the hits and annotates the number in the block located at the bottom of the column for Stage II Day, CBRN, Standing. The scorer checks whether the Soldier is a GO or NO GO.
- Block 13- Lane safeties or designated NCOs, assigned as lane scorers, enter an X on the target block if the Soldier hit the target. The scorer totals the hits and annotates the number in the block located at the bottom of the column for Stage III Night, Standing. The scorer checks whether the Soldier is a GO or NO GO.
- Block 14- Graders enter total hits from phase's I through III into this block to determine the firers' final qualification rating.
- Block 15- Graders use the rating calculated from the previous block to correspond with the correct rating for the awarding of a marksmanship badge. The firers rating is based upon the total number of hits from Stage 1, and by receiving all GO's during Stage II and III. Should firer fail to hit the minimum number of targets or receive a NO GO they are rated as unqualified. Subsequent attempts regardless of number of hits will result in a rating of marksman.
- Block 16- Lane safeties or designated NCOs, assigned as lane scorers, enter any necessary remarks pertaining to firer's performance.
- Block 17- The range OIC enters their full name, printed, and their rank into this block.

- Block 18- The range OIC signs this block.
- Block 19- The commander of the firers unit signs this block certifying the Soldier has completed the table.

| PISTOL SCORECARD | | | | | | | | | | | | | | | | | | | |
|---|--------------|-------------------------------------|-----|---|-------------------------------------|-----|--------------|---|------------------------------|--------------|-------------------------------------|---|-------------------------------------|-------------------------------------|--|------------------------|--|--|--|
| For use of this form, see TC 3-20.40; the proponent agency is TRADOC. | | | | | | | | | | | | | | | | | | | |
| 1. NAME (LAST, FIRST, MI) MILLER, WILLIAM U. | | | | 2. RANK SFC | | | | 3. DOD ID No. 1345678902 | | | | 4. DATE (YYYYMMDD) 20190802 | | | | | | | |
| 5. LANE/FIRING ORDER 6 / FO 3 | | | | 6. WEAPON TYPE M17 | | | | 7. EQUIPMENT N/A | | | | 8. TABLE NUMBER (CHECK ONE) TABLE V PRACTICE <input checked="" type="checkbox"/> TABLE VI QUALIFICATION <input type="checkbox"/> | | | | | | | |
| STAGE I | | | | STAGE II | | | | STAGE III | | | | 16. REMARKS SM fired Table V in full kit. | | | | | | | |
| 9. PHASE 1 DAY, STANDING | | | | 10. PHASE 2 DAY, KNEELING | | | | 11. PHASE 3 DAY, MOVING | | | | 12. DAY, CBRN STANDING | | | | 13. NIGHT, STANDING | | | |
| 1 MAGAZINE 10 ROUNDS | | | | 1 MAGAZINE 10 ROUNDS | | | | 1 MAGAZINE 10 ROUNDS | | | | 1 MAGAZINE 7 ROUNDS | | | | 1 MAGAZINE 5 ROUNDS | | | |
| ENG | RANGE (m) | HIT | ENG | RANGE (m) | HIT | ENG | RANGE (m) | HIT | ENG | RANGE (m) | HIT | ENG | RANGE (m) | HIT | | | | | |
| 1 | 7L | <input checked="" type="checkbox"/> | 10 | 23 | <input checked="" type="checkbox"/> | 18 | 7L | <input checked="" type="checkbox"/> | 1 | 7L | <input checked="" type="checkbox"/> | 1 | 10 | <input checked="" type="checkbox"/> | | | | | |
| 2 | 12.5 | <input checked="" type="checkbox"/> | 11 | 31 | <input checked="" type="checkbox"/> | 18 | 7R | <input checked="" type="checkbox"/> | 2 | 12.5 | <input checked="" type="checkbox"/> | 2 | 12.5 | <input checked="" type="checkbox"/> | | | | | |
| 3 | 23 | <input checked="" type="checkbox"/> | 12 | 16.5 | <input checked="" type="checkbox"/> | 19 | 10 | <input checked="" type="checkbox"/> | 3 | 23 | <input checked="" type="checkbox"/> | 3 | 16.5 | <input checked="" type="checkbox"/> | | | | | |
| 4 | 31 | <input checked="" type="checkbox"/> | 13 | 27 | <input checked="" type="checkbox"/> | 19 | 12.5 | <input checked="" type="checkbox"/> | 4 | 31 | <input type="checkbox"/> | 4 | 7L | <input checked="" type="checkbox"/> | | | | | |
| 5 | 10 | <input checked="" type="checkbox"/> | 14 | 7R | <input checked="" type="checkbox"/> | 20 | 16.5 | <input checked="" type="checkbox"/> | 5 | 10 | <input checked="" type="checkbox"/> | 4 | 7R | <input checked="" type="checkbox"/> | | | | | |
| 6 | 16.5 | <input checked="" type="checkbox"/> | 14 | 10 | <input checked="" type="checkbox"/> | 20 | 23 | <input checked="" type="checkbox"/> | 6 | 10 | <input checked="" type="checkbox"/> | STAGE III TOTAL HITS GO | | | | | | | |
| 7 | 27 | <input checked="" type="checkbox"/> | 15 | 12.5 | <input checked="" type="checkbox"/> | 21 | 23 | <input checked="" type="checkbox"/> | 6 | 12.5 | <input checked="" type="checkbox"/> | 3 - 5 | TOTAL HITS GO | <input checked="" type="checkbox"/> | | | | | |
| 8 | 7R | <input checked="" type="checkbox"/> | 16 | 23 | <input checked="" type="checkbox"/> | 21 | 27 | <input checked="" type="checkbox"/> | STAGE II TOTAL HITS GO | | | | 6 < 3 NO GO | | | | | | |
| 9 | 10 | <input checked="" type="checkbox"/> | 17 | 16.5 | <input checked="" type="checkbox"/> | 22 | 27 | <input checked="" type="checkbox"/> | 4 - 7 GO | | | | <input checked="" type="checkbox"/> | | | | | | |
| 9 | 12.5 | <input checked="" type="checkbox"/> | 17 | 12.5 | <input checked="" type="checkbox"/> | 23 | 31 | <input checked="" type="checkbox"/> | < 4 NO GO | | | | <input type="checkbox"/> | | | | | | |
| PHASE 1 TOTAL HITS | | | | PHASE 2 TOTAL HITS | | | | PHASE 3 TOTAL HITS | | | | 15. QUALIFICATION RATING | | | | | | | |
| 10 | | | | 10 | | | | 10 | | | | 27 - 30 <input checked="" type="checkbox"/> EXPERT | | | | | | | |
| 14. STAGE I TOTAL HITS | | | | 30 | | | | | | | | 24 - 26 <input type="checkbox"/> SHARPSHOOTER | | | | | | | |
| LEGEND: | | | | | | | | | | | | 21 - 23 <input type="checkbox"/> MARKSMAN | | | | | | | |
| CBRN - Chemical, Biological, Radiological, and Nuclear; | | | | | | | | | | | | < 21 <input type="checkbox"/> UNQUALIFIED | | | | | | | |
| DOD ID No. - Department of Defense Identification Number; | | | | | | | | | | | | FOR OFFICIAL USE ONLY | | | | | | | |
| OIC - officer-in-charge; | | | | | | | | | | | | | | | | | | | |
| ENG - engagement; | | | | | | | | | | | | | | | | | | | |
| m - meters. | | | | | | | | | | | | | | | | | | | |
| 17. RANGE OIC PRINTED NAME AND RANK WILSON, JAMES Y. 1LT | | | | 18. RANGE OIC SIGNATURE WILSON, JAMES Y. 1234567890 | | | | 19. CERTIFYING OFFICIAL SIGNATURE (COMMANDER) Williams, Noah K. 1456789023 | | | | | | | | | | | |
| | | | | Digitally signed by WILSON, JAMES Y. 1234567890 Date: 2019.08.02 09:36:39 -0400 | | | | | | | | | | | | | | | |

DA FORM 7814, JUL 2019

APD AEM v1.00ES

Figure B-7. Completed DA Form 7814 (Pistol Scorecard), example

DA FORM 7821, PISTOL VALIDATION SCORECARD

B-13. The trainer uses the DA Form 7821, (*Pistol Validation Scorecard*), (see figure B-8 on page B-13) to record the firer's performance during an authorized validation event. Go to the APD website found in the references section at the back of this manual for a downloadable / printable copy. This form is one page.

B-14. The Soldier or first line leader uses blocks 1 through 8 to enter administrative information. Blocks 9 through 12 are used by the lane safety or designated NCO to score and record firing information. Blocks 14 and 15 are used by the range OIC to verify the completeness and accuracy of the information on the scorecard. Block 16 is used by the unit commander to certify the qualification status and rating of the firer.

- Block 1- The Soldier or leader enters the firers' name (last name, first name, and middle initial).
- Block 2- The Soldier or leader enters the firers rank.
- Block 3- The Soldier or leader enters the ID Code (DODID number located on the reverse side of the Soldiers' CAC).
- Block 4- The Soldier or leader enters the date the firing took place (year-month-day).
- Block 5- The Soldier or leader enters the lane and firing order the Soldier fired in.
- Block 6- The Soldier or leader enters the weapon type (M9, M11, or M17 / M18).
- Block 7- The Soldier or leader enters any attached equipment to the weapon.
- Block 8- The Soldier or leader checks the block used to denote the validation table.

- Block 9- Lane safeties or designated NCOs, assigned as lane scorers, enter an “X” on the target block if the Soldier hit the target. The scorer totals the number of hits and annotates the number in the block located at the bottom of the column for Phase I Day, Standing.
- Block 10- Lane safeties or designated NCOs, assigned as lane scorers, enter an “X” on the target block if the Soldier hit the target. The scorer totals the number of hits and annotates the number in the block located at the bottom of the column for Phase II Day, Kneeling.
- Block 11- Lane safeties or designated NCOs, assigned as lane scorers, enter an “X” on the target block if the Soldier hit the target. The scorer totals the number of hits and annotates the number in the block located at the bottom of the column for Phase III Day, Prone.
- Block 12- Graders enter total hits from phases I through III into this block to determine the firers’ final score. And mark the appropriate validation rating.
- Block 13- Trainers use the block to record any remarks pertaining to the Soldiers performance.
- Block 14- The range OIC enters their full name, printed, and their rank into this block.
- Block 15- The range OIC signs this block.
- Block 16- The commander of the firers unit signs this block certifying the Soldier has completed the table.

| PISTOL VALIDATION SCORECARD | | | | | | | | | | | | | | | | | |
|--|-------------------------------------|-------|-------------------------------------|---|-------------------------------------|-----------------------------|-------------------------------------|---|--|-------|-------------------------------------|--|--|--|---|--|--|
| For use of this form, see TC 3-20.40; the proponent agency is TRADOC. | | | | | | | | | | | | | | | | | |
| 1. NAME (LAST, FIRST, MI) MILLER, WILLIAM U. | | | 2. RANK SFC | | | 3. DOD ID No. 1345678902 | | | 4. DATE (YYYYMMDD) 20190802 | | | | | | | | |
| 5. LANE/FIRING ORDER 11 / FO 2 | | | 6. WEAPON TYPE M9 | | | 7. EQUIPMENT N/A | | | 8. TABLE NUMBER VALIDATION TABLE VI | | | | | | | | |
| 9. PHASE 1 DAY, STANDING 35 SECONDS* | | | | 10. PHASE 2 DAY, KNEELING 35 SECONDS* | | | | 11. PHASE 3 DAY, PRONE 35 SECONDS | | | | 12. VALIDATION RATING | | | | | |
| 1 MAGAZINE 10 ROUNDS | | | | 1 MAGAZINE 10 ROUNDS | | | | 1 MAGAZINE 10 ROUNDS | | | | TOTAL HITS | | | | | |
| | | | | | | | | | | | | 24 | | | | | |
| ROUND | HIT | ROUND | HIT | ROUND | HIT | ROUND | HIT | ROUND | HIT | ROUND | HIT | 24 - 30 <input checked="" type="checkbox"/> VALIDATED < 24 <input type="checkbox"/> UNQUALIFIED | | | | | |
| 1 | <input checked="" type="checkbox"/> | 6 | <input checked="" type="checkbox"/> | 1 | <input checked="" type="checkbox"/> | 6 | <input checked="" type="checkbox"/> | 1 | <input checked="" type="checkbox"/> | 6 | <input checked="" type="checkbox"/> | | | | | | |
| 2 | <input checked="" type="checkbox"/> | 7 | <input checked="" type="checkbox"/> | 2 | <input checked="" type="checkbox"/> | 7 | <input checked="" type="checkbox"/> | 2 | <input checked="" type="checkbox"/> | 7 | <input checked="" type="checkbox"/> | | | | | | |
| 3 | <input checked="" type="checkbox"/> | 8 | <input checked="" type="checkbox"/> | 3 | <input checked="" type="checkbox"/> | 8 | <input checked="" type="checkbox"/> | 3 | <input checked="" type="checkbox"/> | 8 | <input type="checkbox"/> | | | | | | |
| 4 | <input checked="" type="checkbox"/> | 9 | <input type="checkbox"/> | 4 | <input checked="" type="checkbox"/> | 9 | <input type="checkbox"/> | 4 | <input checked="" type="checkbox"/> | 9 | <input type="checkbox"/> | | | | | | |
| 5 | <input checked="" type="checkbox"/> | 10 | <input type="checkbox"/> | 5 | <input checked="" type="checkbox"/> | 10 | <input type="checkbox"/> | 5 | <input checked="" type="checkbox"/> | 10 | <input type="checkbox"/> | | | | | | |
| PHASE 1 - TOTAL HITS | | | 9 | | | PHASE 2 - TOTAL HITS | | | 8 | | | PHASE 3 - TOTAL HITS | | | 7 | | |
| 13. REMARKS SM fired validation in full kit. | | | | | | | | | | | | | | | | | |
| LEGEND: DOD ID No. - Department of Defense Identification Number; OIC - officer-in-charge | | | | | | | | | | | | | | | | | |
| * Firer has ten (10) second pause for a reload conducted between the first and second magazine as well as between the second and third magazine. | | | | | | | | | | | | | | | | | |
| 14. RANGE OIC PRINTED NAME AND RANK WILSON, JAMES Y. 1LT | | | | 15. RANGE OIC SIGNATURE WILSON, JAMES Y. 1234567890 | | | | Digitally signed by WILSON, JAMES Y. 1234567890 Date: 2019.08.02 08:06:39 -0400 | | | | 16. CERTIFYING OFFICIAL SIGNATURE (COMMANDER) Williams, Noah K. 1456789023 | | | | | |

DA FORM 7821, JUL 2019

APD AEM V1 00ES

Figure B-8. Completed DA Form 7821 (Pistol Validation Scorecard), example

DA FORM 7822, RIFLE AND CARBINE VALIDATION SCORECARD

B-15. The trainer uses the DA Form 7822, (*Rifle and Carbine Validation Scorecard*), (see figure B-9 on page B-16) to record the firer's performance during an authorized validation event. Go to the APD website found in the references section at the back of this manual for a downloadable / printable copy. This form is one page.

B-16. The Soldier or first line leader uses blocks 1 through 8 to enter administrative information. Blocks 9 through 22 are used by the lane safety or designated NCO to score and record firing information. Blocks 23 and 24 are used by the range OIC to verify the completeness and accuracy of the information on the scorecard. Block 25 is used by the unit commander to certify the qualification status and rating of the firer.

- Block 1- The Soldier or leader enters the firers' name (last name, first name, and middle initial).
- Block 2- The Soldier or leader enters the firers rank.
- Block 3- The Soldier or leader enters the ID Code (DODID number located on the reverse side of the Soldiers' CAC).
- Block 4- The Soldier or leader enters the date the firing took place (year-month-day).
- Block 5- The Soldier or leader enters the lane and firing order the Soldier fired in.
- Block 6- The Soldier or leader enters the weapon type (M4 or M16).
- Block 7- The Soldier or leader enters any attached equipment to the weapon.
- Block 8- The Soldier or leader checks the block used to denote the validation table.
- Block 9- Lane safeties or designated NCOs, assigned as lane scorers, enter a checkmark in the hit block of the target the Soldier engaged during Stage I, Phase I, Prone Unsupported.
- Block 10- Lane safeties or designated NCOs, assigned as lane scorers, enter a checkmark in the hit block of the target the Soldier engaged during Stage I, Phase II, Prone Supported.
- Block 11- Lane safeties or designated NCOs, assigned as lane scorers, enter a checkmark in the hit block of the target the Soldier engaged during Stage I, Phase III, Kneeling Supported.
- Block 12- Lane safeties or designated NCOs, assigned as lane scorers, enter a checkmark in the hit block of the target the Soldier engaged during Stage I, Phase IV, Standing Supported.
- Block 13- Graders determine the total hits located inside of each target silhouettes 6 minute of angle (MOA) circle for each range from phase's I through IV. If the firer has successfully placed a minimum of three rounds into the 6 MOA circle the scorer places a mark inside the GO check box for the corresponding target. If the Soldier has failed to achieve the minimum number of hits the scorer places a mark in the NO GO box for the corresponding target.
- Block 14- The scorer uses the information from Block 13 to determine the Firers Go or NO-GO rating for Stage I, Slow Fire.
- Block 15- Lane safeties or designated NCOs, assigned as lane scorers, enter a checkmark in the hit block of the target the Soldier engaged during Stage II, Phase I, Prone Unsupported.
- Block 16- Lane safeties or designated NCOs, assigned as lane scorers, enter a checkmark in the hit block of the target the Soldier engaged during Stage II, Phase II, Prone Supported.
- Block 17- Lane safeties or designated NCOs, assigned as lane scores, enter a checkmark in the hit or miss block of the target the Soldier engaged during Stage II, Phase III, Kneeling Supported.
- Block 18- Lane safeties or designated NCOs, assigned as lane scorers, enter a checkmark into the hit or miss block of the target the Soldier engaged during Stage II, Phase IV, Standing Supported.
- Block 19- Graders determine the total hits located inside of each target silhouettes for each range from phases I through IV. If the firer has successfully placed a minimum of 3 rounds into each targets silhouette the scorer places a mark inside the GO check box for the corresponding target. If the Soldier has failed to achieve the minimum number of hits the scorer places a mark in the NO GO box for the corresponding target.
- Block 20- The scorer uses the information from Block 19 to determine the Firers Go or NO GO rating for Stage II, Rapid Fire.
- Block 21- Lane safeties or designated NCOs, assigned as lane scorers, enter any necessary remarks pertaining to firer's performance.

- Block 22- Graders use the ratings calculated from block 14 and block 20 to annotate whether the Soldier has successfully validated their previous qualification rating. Failure to achieve a Go on both stages results in a failure to validate.
- Block 23- The range OIC enters their full name, printed, and their rank into this block.
- Block 24- The range OIC signs this block.
- Block 25- The commander of the firers unit signs this block certifying the Soldier has completed the table.

| RIFLE AND CARBINE VALIDATION SCORECARD | | | | | | | | | | | | | | | | | | | | | | | |
|---|---|-------------------------------------|--|-------------------------------------|---|-------------------------------------|---|-------------------------------------|--|--|--------------------------|--|-------------------------------------|--|--|---|-------------------------------------|---|-------------------------------------|---|--------------------------|-------------------------------------|--------------------------|
| For use of this form, see TC 3-20.40; the proponent agency is TRADOC. | | | | | | | | | | | | | | | | | | | | | | | |
| 1. NAME (LAST, FIRST, MI) MILLER, WILLIAM U. | | | | | 2. RANK SFC | | | | | 3. DOD ID No. 1345678902 | | | | | 4. DATE (YYYYMMDD) 20190802 | | | | | | | | |
| 5. LANE/FIRING ORDER 2 / FO 1 | | | | | 6. WEAPON TYPE M4A1 | | | | | 7. EQUIPMENT M68 | | | | | 8. TABLE NUMBER VALIDATION TABLE VI | | | | | | | | |
| STAGE I, SLOW FIRE | | | | | | | | | | STAGE II, RAPID FIRE | | | | | | | | | | | | | |
| RANGE (m) | 9. PHASE 1 PRONE UNSUPPORTED 60 SECONDS | | 10. PHASE 2 PRONE SUPPORTED 60 SECONDS | | 11. PHASE 3 KNEELING 60 SECONDS | | 12. PHASE 4 STANDING SUPPORTED 60 SECONDS | | 13. MINIMUM OF 3 HITS IN 6 MOA CIRCLE AT EACH DISTANCE | | RANGE (m) | 15. PHASE 1 PRONE UNSUPPORTED 30 SECONDS | | 16. PHASE 2 PRONE SUPPORTED 30 SECONDS | | 17. PHASE 3 KNEELING SUPPORTED 30 SECONDS | | 18. PHASE 4 STANDING SUPPORTED 30 SECONDS | | 19. MINIMUM OF 3 HITS IN EACH SILHOUETTE AT EACH DISTANCE | | | |
| | RND | HIT | RND | HIT | RND | HIT | RND | HIT | GO | NO GO | | RND | HIT | RND | HIT | RND | HIT | RND | HIT | GO | NO GO | | |
| 250 | 1 | <input checked="" type="checkbox"/> | 11 | <input checked="" type="checkbox"/> | 21 | <input checked="" type="checkbox"/> | 31 | <input checked="" type="checkbox"/> | <input checked="" type="checkbox"/> | <input type="checkbox"/> | 250 | 1 | <input type="checkbox"/> | 11 | <input checked="" type="checkbox"/> | 21 | <input checked="" type="checkbox"/> | 31 | <input checked="" type="checkbox"/> | <input checked="" type="checkbox"/> | <input type="checkbox"/> | | |
| 300 | 2 | <input checked="" type="checkbox"/> | 12 | <input checked="" type="checkbox"/> | 22 | <input type="checkbox"/> | 32 | <input type="checkbox"/> | <input checked="" type="checkbox"/> | <input type="checkbox"/> | 300 | 2 | <input checked="" type="checkbox"/> | 12 | <input checked="" type="checkbox"/> | 22 | <input type="checkbox"/> | 32 | <input type="checkbox"/> | <input checked="" type="checkbox"/> | <input type="checkbox"/> | | |
| 150 L | 3 | <input checked="" type="checkbox"/> | 13 | <input checked="" type="checkbox"/> | 23 | <input checked="" type="checkbox"/> | 33 | <input type="checkbox"/> | <input checked="" type="checkbox"/> | <input type="checkbox"/> | 150 L | 3 | <input checked="" type="checkbox"/> | 13 | <input type="checkbox"/> | 23 | <input checked="" type="checkbox"/> | 33 | <input checked="" type="checkbox"/> | <input checked="" type="checkbox"/> | <input type="checkbox"/> | | |
| 200 L | 4 | <input checked="" type="checkbox"/> | 14 | <input checked="" type="checkbox"/> | 24 | <input checked="" type="checkbox"/> | 34 | <input type="checkbox"/> | <input checked="" type="checkbox"/> | <input type="checkbox"/> | 200 L | 4 | <input checked="" type="checkbox"/> | 14 | <input checked="" type="checkbox"/> | 24 | <input checked="" type="checkbox"/> | 34 | <input checked="" type="checkbox"/> | <input checked="" type="checkbox"/> | <input type="checkbox"/> | | |
| 200 R | 5 | <input checked="" type="checkbox"/> | 15 | <input checked="" type="checkbox"/> | 25 | <input checked="" type="checkbox"/> | 35 | <input type="checkbox"/> | <input checked="" type="checkbox"/> | <input type="checkbox"/> | 200 R | 5 | <input checked="" type="checkbox"/> | 15 | <input checked="" type="checkbox"/> | 25 | <input type="checkbox"/> | 35 | <input checked="" type="checkbox"/> | <input checked="" type="checkbox"/> | <input type="checkbox"/> | | |
| 150 R | 6 | <input checked="" type="checkbox"/> | 16 | <input type="checkbox"/> | 26 | <input checked="" type="checkbox"/> | 36 | <input checked="" type="checkbox"/> | <input checked="" type="checkbox"/> | <input type="checkbox"/> | 150 R | 6 | <input checked="" type="checkbox"/> | 16 | <input checked="" type="checkbox"/> | 26 | <input type="checkbox"/> | 36 | <input checked="" type="checkbox"/> | <input checked="" type="checkbox"/> | <input type="checkbox"/> | | |
| 100 L | 7 | <input checked="" type="checkbox"/> | 17 | <input checked="" type="checkbox"/> | 27 | <input checked="" type="checkbox"/> | 37 | <input checked="" type="checkbox"/> | <input checked="" type="checkbox"/> | <input type="checkbox"/> | 100 L | 7 | <input checked="" type="checkbox"/> | 17 | <input type="checkbox"/> | 27 | <input type="checkbox"/> | 37 | <input checked="" type="checkbox"/> | <input checked="" type="checkbox"/> | <input type="checkbox"/> | | |
| 100 C | 8 | <input checked="" type="checkbox"/> | 18 | <input type="checkbox"/> | 28 | <input type="checkbox"/> | 38 | <input checked="" type="checkbox"/> | <input type="checkbox"/> | <input checked="" type="checkbox"/> | 100 C | 8 | <input checked="" type="checkbox"/> | 18 | <input checked="" type="checkbox"/> | 28 | <input checked="" type="checkbox"/> | 38 | <input checked="" type="checkbox"/> | <input checked="" type="checkbox"/> | <input type="checkbox"/> | | |
| 100 R | 9 | <input checked="" type="checkbox"/> | 19 | <input checked="" type="checkbox"/> | 29 | <input type="checkbox"/> | 39 | <input checked="" type="checkbox"/> | <input checked="" type="checkbox"/> | <input type="checkbox"/> | 100 R | 9 | <input checked="" type="checkbox"/> | 19 | <input checked="" type="checkbox"/> | 29 | <input checked="" type="checkbox"/> | 39 | <input type="checkbox"/> | <input checked="" type="checkbox"/> | <input type="checkbox"/> | | |
| 50 | 10 | <input type="checkbox"/> | 20 | <input checked="" type="checkbox"/> | 30 | <input checked="" type="checkbox"/> | 40 | <input checked="" type="checkbox"/> | <input checked="" type="checkbox"/> | <input type="checkbox"/> | 50 | 10 | <input type="checkbox"/> | 20 | <input checked="" type="checkbox"/> | 30 | <input checked="" type="checkbox"/> | 40 | <input checked="" type="checkbox"/> | <input checked="" type="checkbox"/> | <input type="checkbox"/> | | |
| 14. MINIMUM OF 7 GO: | | | | | | | | | | <input checked="" type="checkbox"/> | <input type="checkbox"/> | 20. MINIMUM OF 7 GO: | | | | | | | | | | <input checked="" type="checkbox"/> | <input type="checkbox"/> |
| 21. REMARKS SM fired validation in full kit. | | | | | | | | | | 22. RATING RECEIVED GO ON STAGE I (BLOCK 14) AND STAGE II (BLOCK 20) <input checked="" type="checkbox"/> VALIDATED FAILURE TO ACHIEVE A GO ON BOTH STAGES EQUALS FAILURE TO VALIDATE <input type="checkbox"/> UNQUALIFIED STAGE I AND II GO <input type="checkbox"/> STAGE I OR II NO GO <input type="checkbox"/> | | | | | | | | | | | | | |
| 23. RANGE OIC PRINTED NAME AND RANK WILSON, JAMES Y. 1LT | | | | | 24. RANGE OIC SIGNATURE WILSON, JAMES Y. 1234567890 | | | | | 25. CERTIFYING OFFICIAL SIGNATURE (COMMANDER) Williams, Noah K. 1456789023 | | | | | | | | | | | | | |

Figure B-9. Completed DA Form 7822 (Rifle and Carbine Validation Scorecard) example

DA FORM 7489, NIGHT FIRE, ASSISTED, RIFLE MARKSMANSHIP SCORECARD

B-17. The trainer uses the DA Form 7489, (*Night Fire, Assisted, Rifle Marksmanship Scorecard*), (see figure B-10, on page B-18) to record the firer’s performance on Tables V, Practice and VI, Certification. Go to the APD website found in the references section at the back of this manual for a downloadable / printable copy. This form is one page.

B-18. The Soldier or first line leader uses blocks 1 through 8 to enter administrative information. Blocks 9 through 16 are used by the lane safety or designated NCO to score and record firing information. Block 15 displays the firer’s certification rating. Blocks 17 and 18 are used by the range OIC to verify the completeness and accuracy of the information on the scorecard. Block 19 is used by the unit commander to certify the qualification status and rating of the team.

- Block 1- The Soldier or leader enters the firer’s name.
- Block 2- The Soldier or leader enters the firer’s rank.
- Block 3- The Soldier or leader enters the firer’s DODID number.

- Block 4- The Soldier or leader enters the date fringing took place.
- Block 5- The Soldier or leader enters the lane and firing order the Soldier fired in.
- Block 6- The Soldier or leader enters the weapon type (M4 / M16 / M249AR).
- Block 7- The Soldier or leader enters the equipment and/or optic used during the firing events.
- Block 8- The Soldier or leader checks the appropriate table box for either practice or certification.
- Block 9- Lane safeties or designated NCOs, assigned as lane scorers, enter a checkmark in the hit block of the target the Soldier engaged. The scorer totals the hits and records the information in for Phase I, Prone Unsupported at the bottom of the column.
- Block 10- Lane safeties or designated NCOs, assigned as lane scorers, enter a checkmark in the hit block of the target the Soldier engaged. The scorer totals the hits and records the information in for Phase II, Prone Supported at the bottom of the column.
- Block 11- Lane safeties or designated NCOs, assigned as lane scorers, enter a checkmark in the hit block of the target the Soldier engaged. The scorer totals the hits and records the information in for Phase III, Kneeling Supported at the bottom of the column.
- Block 12- Lane safeties or designated NCOs, assigned as lane scorers, enter a checkmark in the hit block of the target the Soldier engaged. The scorer totals the hits and records the information in for Phase IV, Standing Supported at the bottom of the column.
- Block 13- Lane safeties or designated NCOs, assigned as lane scorers, enter a checkmark in the hit block of the target the Soldier engaged. The scorer totals the hits and records the information for Stage II, Standing Supported, CBRN at the bottom of the column.
- Block 14- The scorer transfers the total number of hits from Stage I and Sage II and calculates the table total.
- Block 15- The scorer uses the total from the previous block to determine the firers appropriate certification rating.
- Block 16- Lane safeties or designated NCOs, assigned as lane scorers, enter any necessary remarks pertaining to firer's performance.
- Block 17- The range OIC enters their full name, printed, and their rank into this block.
- Block 18- The range OIC signs this block.
- Block 19- The commander of the firers unit signs this block certifying the Soldier has completed the table.

| NIGHT FIRE, ASSISTED, RIFLE MARKSMANSHIP SCORECARD | | | | | | | | | | | | | | | | |
|---|--------------------------|-------------------------------------|---|-------------------------------------|-------------------------------------|-----------------------------------|-------------------------------------|-------------------------------------|---|-------------------------------------|-------------------------------------|--------------------------------|--------------------------|-------------------------------------|-------------------------------------|-------------------------------------|
| For use of this form, see TC 3-20.40; the proponent agency is TRADOC. | | | | | | | | | | | | | | | | |
| 1. NAME (LAST, FIRST, MI) MILLER, WILLIAM U. | | | 2. RANK SFC | | | 3. DOD ID No. 1345678902 | | | 4. DATE (YYYYMMDD) 20190802 | | | | | | | |
| 5. LANE/FIRING ORDER 1 / FO 1 | | | 6. WEAPON TYPE M4A1 | | | 7. EQUIPMENT/OPTICS AN/PAS-13 | | | 8. TABLE NUMBER (CHECK ONE) TABLE V PRACTICE <input checked="" type="checkbox"/> TABLE VI CERTIFICATION <input type="checkbox"/> | | | | | | | |
| STAGE I | | | | | | | | | | | | STAGE II | | | | |
| 9. PHASE 1 PRONE UNSUPPORTED | | | 10. PHASE 2 PRONE SUPPORTED | | | 11. PHASE 3 KNEELING SUPPORTED | | | 12. PHASE 4 STANDING SUPPORTED | | | 13. CBRN STANDING SUPPORTED | | | | |
| ENG | RANGE (m) | HIT | ENG | RANGE (m) | HIT | ENG | RANGE (m) | HIT | ENG | RANGE (m) | HIT | ENG | RANGE (m) | HIT | | |
| 1 | 50 R | <input checked="" type="checkbox"/> | 6 | 50 R | <input checked="" type="checkbox"/> | 11 | 50 L | <input checked="" type="checkbox"/> | 15 | 50 L | <input checked="" type="checkbox"/> | 1 | 50 L | <input checked="" type="checkbox"/> | | |
| 2 | 150 | <input checked="" type="checkbox"/> | 7 | 150 | <input checked="" type="checkbox"/> | | 200 | <input checked="" type="checkbox"/> | 16 | 100 | <input checked="" type="checkbox"/> | | 2 | 100 | <input checked="" type="checkbox"/> | |
| 3 | 200 | <input checked="" type="checkbox"/> | 8 | 300 | <input checked="" type="checkbox"/> | | 250 | <input checked="" type="checkbox"/> | 17 | 200 | <input checked="" type="checkbox"/> | | 3 | 200 | <input checked="" type="checkbox"/> | |
| 4 | 100 | <input checked="" type="checkbox"/> | 9 | 200 | <input checked="" type="checkbox"/> | 12 | 50 R | <input checked="" type="checkbox"/> | 16 | 250 | <input type="checkbox"/> | 4 | 250 | <input checked="" type="checkbox"/> | | |
| | 150 | <input checked="" type="checkbox"/> | | 300 | <input checked="" type="checkbox"/> | | 200 | <input type="checkbox"/> | | 50 R | <input checked="" type="checkbox"/> | | 50 R | <input checked="" type="checkbox"/> | 300 | <input checked="" type="checkbox"/> |
| 5 | 200 | <input checked="" type="checkbox"/> | 10 | 250 | <input checked="" type="checkbox"/> | 13 | 150 | <input checked="" type="checkbox"/> | 17 | 100 | <input checked="" type="checkbox"/> | 4 | 100 | <input checked="" type="checkbox"/> | | |
| | 100 | <input checked="" type="checkbox"/> | | 300 | <input checked="" type="checkbox"/> | | 250 | <input checked="" type="checkbox"/> | | 150 | <input checked="" type="checkbox"/> | | 250 | <input checked="" type="checkbox"/> | 250 | <input type="checkbox"/> |
| | 200 | <input checked="" type="checkbox"/> | | 150 | <input checked="" type="checkbox"/> | | 100 | <input checked="" type="checkbox"/> | | 200 | <input checked="" type="checkbox"/> | | 300 | <input checked="" type="checkbox"/> | 300 | <input checked="" type="checkbox"/> |
| 250 | <input type="checkbox"/> | | 300 | <input checked="" type="checkbox"/> | 14 | 300 | <input checked="" type="checkbox"/> | 18 | 250 | <input checked="" type="checkbox"/> | | 250 | <input type="checkbox"/> | | | |
| PHASE 1 TOTAL 9 | | | PHASE 2 TOTAL 10 | | | PHASE 3 TOTAL 9 | | | PHASE 4 TOTAL 9 | | | STAGE II TOTAL 9 | | | | |
| 14. TABLE TOTAL | | | 16. REMARKS SM fired Table V in full kit. | | | | | | | | | | | | | |
| STAGE I TOTAL 37 | | | LEGEND: DOD ID No. - Department of Defense Identification Number; CBRN - Chemical, Biological, Radiological, and Nuclear; m - meters; ENG - engagement; OIC - officer-in-charge. | | | | | | | | | | | | | |
| STAGE II TOTAL 9 | | | | | | | | | | | | | | | | |
| TOTAL SCORE 46 | | | | | | | | | | | | | | | | |
| 15. CERTIFICATION RATING | | | FOR OFFICIAL USE ONLY | | | | | | | | | | | | | |
| 35 - 50 <input checked="" type="checkbox"/> CERTIFIED | | | | | | | | | | | | | | | | |
| < 35 <input type="checkbox"/> UNCERTIFIED | | | 17. RANGE OIC PRINTED NAME AND RANK WILSON, JAMES Y. ILT | | | | | | | | | | | | | |
| | | | 18. RANGE OIC SIGNATURE WILSON, JAMES Y. 1234567890 | | | | | | 19. CERTIFYING OFFICIAL SIGNATURE (COMMANDER) Williams, Noah K. 1456789023 | | | | | | | |
| | | | Digitally signed by WILSON, JAMES Y. 1234567890 Date: 2019.08.02 09:58:39 -04'00' | | | | | | | | | | | | | |

Figure B-10. Completed DA Form 7489 (Night Fire, Assisted, Rifle Marksmanship Scorecard) example

DA FORM 7801, RIFLE, CARBINE, AND AUTOMATIC RIFLE MARKSMANSHIP SCORECARD

B-19. The trainer uses the DA Form 7801, (*Rifle, Carbine, and Automatic Rifle Marksmanship Scorecard*), (see figures B-11 and B-12, on page B-19) to record the firer’s performance on either Table V, practice or Table VI, qualification. Go to the APD website found in the references section at the back of this manual for a downloadable / printable copy. This form is two pages. Page one is used for standard day live-fire for practice or qualification. Page two is used at the simulations center to record the results of the firers CBRN and night fire certifications.

B-20. The Soldier or first line leader uses blocks 1 through 8 to enter administrative information. Blocks 9 through 15 are used by the lane safety or designated NCO to score and record firing information. Blocks 16 and 17 are used by the range OIC to verify the completeness and accuracy of the information on the scorecard. Block 18 is used by the unit commander to certify the qualification status and rating of the firer. Figures B-11 and B-12, on page B-20, are an example of DA Form 7801.

- PAGE ONE:
 - Block 1- The Soldier or leader enters the firers’ name (last name, first name, and middle initial).
 - Block 2- The Soldier or leader enters the firers rank.
 - Block 3- The Soldier or leader enters the ID Code (DODID number located on the reverse side of the Soldiers’ CAC).
 - Block 4- The Soldier or leader enters the date the firing took place (year-month-day).
 - Block 5- The Soldier or leader enters the lane and firing order the Soldier fired in.
 - Block 6- The Soldier or leader enters the weapon type (M4, M16, M249 automatic rifle).

- Block 7- The Soldier or leader enters any attached equipment to the weapon (M68, M150, M145).
- Block 8- The Soldier or leader checks the appropriate table box for either practice or qualification.
- Block 9- Lane safeties or designated NCOs, assigned as lane scorers, enter a checkmark in the hit block of the target the Soldier engaged. The scorer totals the hits and records the information in Block 13 for Phase I, Prone Unsupported.
- Block 10- Lane safeties or designated NCOs, assigned as lane scorers, enter a checkmark in the hit block of the target the Soldier engaged. The scorer totals the hits and records the information in Block 13 for Phase II, Prone Supported.
- Block 11- Lane safeties or designated NCOs, assigned as lane scorers, enter a checkmark in the hit block of the target the Soldier engaged. The scorer totals the hits and records the information in Block 13 for Phase III, Kneeling Supported.
- Block 12- Lane safeties or designated NCOs, assigned as lane scorers, enter a checkmark in the hit block of the target the Soldier engaged. The scorer totals the hits and records the information in Block 13 for Phase IV, Standing Supported.
- Block 13- Graders enter total hits from Phase I through IV into this block to determine the firers' final score.
- Block 14- This block is the application of qualification rating from the Stage I total in block 13. Graders check a GO or NO-GO rating for Stages II, III, and IV conducted in either simulations or fired live.
- Block 15 – Lane safeties or designated NCOs, assigned as lane scorers, enter any necessary remarks pertaining to firer's performance
- Block 16 – The range OIC enters their full name, printed, and their rank into this block.
- Block 17 – The range OIC signs this block.
- Block 18- The commander of the firers unit signs this block certifying the Soldier has completed the table.
- PAGE TWO
 - Block 19 - Lane safeties or designated NCOs, assigned as lane scorers, enter an X into the target block if the Soldier hit the target. The scorer totals the hits and annotates the number in the block located at the bottom of the column for Stage II Day, CBRN, Standing. The scorer totals the hits at the bottom of the column and checks whether the Soldier is a GO or NO GO.
 - Block 20- Lane safeties or designated NCOs, assigned as lane scorers, enter an X into the target block if the Soldier hit the target. The scorer totals the hits for each phase and annotates the number in the blocks located at the bottom of the column for Stage III Night, Unassisted Fire, Kneeling.
 - Block 21- Lane safeties or designated NCOs, assigned as lane scorers, enter an X into the target block if the Soldier hit the target. The scorer totals the hits for phase 2 and annotates the number in the blocks located at the bottom of the column for Block 20. The scorer totals the hits at the bottom of Block 20 and checks whether the Soldier is a GO or NO GO for Stage III Night, Unassisted Fire, Kneeling.
 - Block 22- Lane safeties or designated NCOs, assigned as lane scorers, enter an X into the target block if the Soldier hit the target. The scorer totals the hits and annotates the number in the block located at the bottom of the column for Stage IV Night, CBRN, Standing. The scorer totals the hits at the bottom of the column and checks whether the Soldier is a GO or NO GO.

| RIFLE, CARBINE, AND AUTOMATIC RIFLE MARKSMANSHIP SCORECARD | | | | | | | | | | | |
|--|-----------|---|--------------------------------|--------------------------------|-------------------------------------|-----------------------------------|-----------|---|---|-----------------------|-------------------------------------|
| For use of this form, see TC 3-20.40; the proponent agency is TRADOC. | | | | | | | | | | | |
| 1. NAME (LAST, FIRST, MI) MILLER, WILLIAM U. | | | 2. RANK SFC | | | 3. DOD ID No. 1345678902 | | | 4. DATE (YYYYMMDD) 20190802 | | |
| 5. LANE/FIRING ORDER 7 / FO 3 | | | 6. WEAPON TYPE M4A1 | | | 7. EQUIPMENT/OPTICS M68 | | | 8. TABLE NUMBER (CHECK ONE) TABLE V PRACTICE <input type="checkbox"/> TABLE VI QUALIFICATION <input checked="" type="checkbox"/> | | |
| STAGE I | | | | | | | | | | | |
| 9. PHASE 1 STANDING UNSUPPORTED TRANSITION TO PRONE UNSUPPORTED | | | 10. PHASE 2 PRONE SUPPORTED | | | 11. PHASE 3 KNEELING SUPPORTED | | | 12. PHASE 4 STANDING SUPPORTED | | |
| ENGAGEMENT | RANGE (m) | HIT | ENGAGEMENT | RANGE (m) | HIT | ENGAGEMENT | RANGE (m) | HIT | ENGAGEMENT | RANGE (m) | HIT |
| 1 | 50 R | <input checked="" type="checkbox"/> | 6 | 100 | <input checked="" type="checkbox"/> | 11 | 50 L | <input checked="" type="checkbox"/> | 15 | 50 L | <input checked="" type="checkbox"/> |
| 2 | 100 | <input checked="" type="checkbox"/> | 7 | 150 | <input checked="" type="checkbox"/> | | 100 | <input checked="" type="checkbox"/> | | 100 | <input checked="" type="checkbox"/> |
| 3 | 150 | <input checked="" type="checkbox"/> | | 300 | <input checked="" type="checkbox"/> | | 200 | <input checked="" type="checkbox"/> | 16 | 200 | <input checked="" type="checkbox"/> |
| 4 | 50 L | <input checked="" type="checkbox"/> | 8 | 200 | <input type="checkbox"/> | 12 | 50 R | <input checked="" type="checkbox"/> | 17 | 250 | <input checked="" type="checkbox"/> |
| | 150 | <input checked="" type="checkbox"/> | | 300 | <input checked="" type="checkbox"/> | | 200 | <input checked="" type="checkbox"/> | | 50 R | <input checked="" type="checkbox"/> |
| 5 | 200 | <input checked="" type="checkbox"/> | 9 | 250 | <input type="checkbox"/> | 13 | 150 | <input checked="" type="checkbox"/> | 18 | 100 | <input checked="" type="checkbox"/> |
| | 250 | <input checked="" type="checkbox"/> | | 300 | <input checked="" type="checkbox"/> | | 250 | <input type="checkbox"/> | | 150 | <input checked="" type="checkbox"/> |
| | 300 | <input checked="" type="checkbox"/> | | 150 | <input checked="" type="checkbox"/> | | 100 | <input checked="" type="checkbox"/> | | 200 | <input checked="" type="checkbox"/> |
| PHASE 1: TOTAL | | | PHASE 2: TOTAL | | | PHASE 3: TOTAL | | | PHASE 4: TOTAL | | |
| 10 | | | 8 | | | 9 | | | 10 | | |
| 13. TABLE TOTAL | | 14. QUALIFICATION RATING | | 15. REMARKS | | | | | | FOR OFFICIAL USE ONLY | |
| PHASE 1: HITS 10 | | 36 - 40 <input checked="" type="checkbox"/> EXPERT | | SM fired Table VI in full kit. | | | | | | | |
| PHASE 2: HITS 8 | | 30 - 35 <input type="checkbox"/> SHARPSHOOTER | | | | | | | | | |
| PHASE 3: HITS 9 | | 23 - 29 <input type="checkbox"/> MARKSMAN | | | | | | | | | |
| PHASE 4: HITS 10 | | < 23 <input type="checkbox"/> UNQUALIFIED | | | | | | | | | |
| STAGE I: TOTAL 37 | | STAGE II <input checked="" type="checkbox"/> GO <input type="checkbox"/> NO GO | | | | | | | | | |
| | | STAGE III <input checked="" type="checkbox"/> GO <input type="checkbox"/> NO GO | | | | | | | | | |
| | | STAGE IV <input checked="" type="checkbox"/> GO <input type="checkbox"/> NO GO | | | | | | | | | |
| LEGEND: DOD ID No. - Department of Defense Identification Number; CBRN - chemical, biological, radiological, and nuclear; m - meters; OIC - officer-in-charge. | | | | 17. RANGE OIC SIGNATURE | | | | 18. CERTIFYING OFFICIAL SIGNATURE (COMMANDER) | | | |
| 16. RANGE OIC PRINTED NAME AND RANK WILSON, JAMES Y. 1LT | | | | WILSON, JAMES Y. 1234567890 | | | | Williams, Noah K. 1456789023 | | | |

DA FORM 7801, JUL 2019

Page 1 of 2
APD AEM v1.00E3

Figure B-11. Completed DA Form 7801, page 1 (Rifle, Carbine, and Automatic Rifle Marksmanship Scorecard) example

| RIFLE, CARBINE, AND AUTOMATIC RIFLE MARKSMANSHIP SCORECARD | | | | | | | | | | | |
|--|-----------|--|-------------------------------------|-------------------------------------|-------------------------------------|-------------------------------------|-------------------------------------|--|--------------------------|-------------------------------------|--|
| STAGE II DAY, CBRN | | | STAGE III NIGHT, UNASSISTED FIRE | | | | | | STAGE IV NIGHT, CBRN | | |
| 19. STANDING UNSUPPORTED | | | 20. PHASE 1 KNEELING SUPPORTED | | | 21. PHASE 2 KNEELING SUPPORTED | | | 22. STANDING UNSUPPORTED | | |
| ENGAGEMENT | RANGE (m) | HIT | ENGAGEMENT | RANGE (m) | HIT | ENGAGEMENT | RANGE (m) | HIT | ENGAGEMENT | RANGE (m) | HIT |
| 1 | 50 R | <input checked="" type="checkbox"/> | 1 | 50 R | <input checked="" type="checkbox"/> | 7 | 50 L | <input checked="" type="checkbox"/> | 1 | 50 R | <input checked="" type="checkbox"/> |
| 2 | 50 L | <input checked="" type="checkbox"/> | 2 | 50 L | <input checked="" type="checkbox"/> | | 50 R | <input checked="" type="checkbox"/> | 2 | 50 L | <input checked="" type="checkbox"/> |
| | 100 | <input checked="" type="checkbox"/> | 3 | 50 R | <input checked="" type="checkbox"/> | 8 | 50 L | <input checked="" type="checkbox"/> | 3 | 100 | <input checked="" type="checkbox"/> |
| 3 | 50 R | <input checked="" type="checkbox"/> | 4 | 50 L | <input checked="" type="checkbox"/> | | 100 | <input checked="" type="checkbox"/> | 4 | 50 L | <input checked="" type="checkbox"/> |
| | 150 | <input type="checkbox"/> | | 100 | <input type="checkbox"/> | 50 L | <input checked="" type="checkbox"/> | 50 R | | <input type="checkbox"/> | |
| 4 | 200 | <input type="checkbox"/> | 5 | 50 L | <input checked="" type="checkbox"/> | 9 | 50 R | <input type="checkbox"/> | 5 | 50 L | <input checked="" type="checkbox"/> |
| 5 | 100 | <input checked="" type="checkbox"/> | | 100 | <input type="checkbox"/> | | 100 | <input checked="" type="checkbox"/> | | 100 | <input checked="" type="checkbox"/> |
| 6 | 150 | <input checked="" type="checkbox"/> | 6 | 50 L | <input checked="" type="checkbox"/> | 10 | 50 L | <input checked="" type="checkbox"/> | 6 | 50 L | <input checked="" type="checkbox"/> |
| 7 | 50 R | <input checked="" type="checkbox"/> | | 50 R | <input checked="" type="checkbox"/> | | 50 R | <input checked="" type="checkbox"/> | | 50 R | <input type="checkbox"/> |
| | 50 L | <input type="checkbox"/> | 100 | <input checked="" type="checkbox"/> | 100 | <input checked="" type="checkbox"/> | 100 | <input checked="" type="checkbox"/> | 100 | <input checked="" type="checkbox"/> | |
| STAGE II: TOTAL | | | STAGE III - PHASE 1: TOTAL | | | STAGE III - PHASE 2: TOTAL | | | STAGE IV: TOTAL | | |
| 7 | | | 8 | | | 9 | | | 8 | | |
| 7 - 10 | | GO <input checked="" type="checkbox"/> | PHASE 1: HITS | | 8 | 14 - 20 | | GO <input checked="" type="checkbox"/> | 7 - 10 | | GO <input checked="" type="checkbox"/> |
| < 7 | | NO GO <input type="checkbox"/> | PHASE 2: HITS | | 9 | < 14 | | NO GO <input type="checkbox"/> | < 7 | | NO GO <input type="checkbox"/> |
| | | | STAGE III: TOTAL | | 17 | | | | | | |

DA FORM 7801, JUL 2019

Page 2 of 2

Figure B-12. Completed DA Form 7801, page 2 (Rifle, Carbine, and Automatic Rifle Marksmanship Scorecard) example

DA FORM 7811, SNIPER SCORECARD

B-21. The trainer uses the DA Form 7811, (*Sniper Scorecard*), (see figure B-13, on page B-21) to record the firer's performance on Table IV and for day and night on Tables V, Practice and VI, Qualification. Go to the APD website found in the references section at the back of this manual for a downloadable / printable copy. This form is one page.

B-22. The Soldier or first line leader uses blocks 1 through 8 to enter administrative information. Blocks 9 through 16 are used by the lane safety or designated NCO to score and record firing information. Block 14 identifies the sniper team member position. Block 15 displays the team's aggregate score, which correlates to a qualification rating. Blocks 17 and 18 are used by the range OIC to verify the completeness and accuracy of the information on the scorecard. Block 19 is used by the unit commander to certify the qualification status and rating of the team.

- Block 1- The Soldier or leader enters the fires name.
- Block 2- The Soldier or leader enters the fires rank.
- Block 3- The Soldier or leader enters the fires DODID Number.
- Block 4- The Soldier or leader enters the date fringing took place.
- Block 5- The Soldier or leader enters the lane and firing order the Soldier fired in.
- Block 6- The Soldier or leader enters the weapon type (M110 / M2010 / M107).
- Block 7- The Soldier or leader enters the equipment and/or optic used during the firing events.
- Block 8- The Soldier or leader checks the appropriate table box for either practice or qualification.
- Block 9- Lane safeties or designated NCOs, assigned as lane scorers, check the appropriate box for any sighting device zeroed during the conduct of Table IV.
- Block 10- Lane safeties or designated NCOs, assigned as lane scorers, provide any remarks they deem necessary during the conduct of Table IV. This block is also used as a glossary of acronyms used on the scorecard.
- Block 11- Lane safeties or designated NCOs, assigned as lane scorers, check whether the target was hit with the first or second round. Fires who hit with the first round are awarded 10 points. Firers who hit with the second round are awarded 5 points. Firers who fail to hit the target do not receive points and the engagement is scored with a zero. The scorer totals all points at the bottom of the column for Phase I, Day Fire.
- Block 12- Lane safeties or designated NCOs, assigned as lane scorers, check whether the target was hit with the first or second round. Fires who hit with the first round are awarded 10 points. Firers who hit with the second round are awarded 5 points. Firers who fail to hit the target do not receive points and the engagement is scored with a zero. The scorer totals all points at the bottom of the column for Phase II, Night Fire.
- Block 13- The scorer transfers the information from phase I and II to determine the sum for the table.
- Block 14- The scorer identifies the sniper team member's position and checks the appropriate box.
- Block 15- Based upon the total number of points depicted in block 13 the scorer then selects the qualification rating that corresponds to the total score.
- Block 16- Lane safeties or designated NCOs, assigned as lane scorers, enter any necessary remarks pertaining to firer's performance.
- Block 17- The range OIC enters their full name, printed, and their rank into this block.
- Block 18- The range OIC signs this block.
- Block 19- The commander of the firers unit signs this block certifying the Soldier has completed the table.

| SNIPER SCORECARD | | | | | | | | | | | | | | | | | | | | |
|---|-------------------------------------|--------------------------|-------------------------------------|---|----------------|-----------------------------------|----------------|---|--|--------|-----|-----------------------|-----------------|-----------------------|-------------------------------------|--------------------------|--------|--------------------------------------|-------------------------------------|--------------|
| For use of this form, see TC 3-20.40; the proponent agency is TRADOC. | | | | | | | | | | | | | | | | | | | | |
| 1. NAME (LAST, FIRST, MI) MILLER, WILLIAM U. | | | 2. RANK SFC | | | 3. DOD ID No. 1345678902 | | | 4. DATE (YYYYMMDD) 20190802 | | | | | | | | | | | |
| 5. LANE/FIRING ORDER 2 / FO 1 | | | 6. WEAPON TYPE M2010 | | | 7. EQUIPMENT/OPTICS SUPPRESSOR | | | 8. TABLE NUMBER (CHECK ONE) TABLE V <input type="checkbox"/> PRACTICE TABLE VI <input checked="" type="checkbox"/> CERTIFICATION | | | | | | | | | | | |
| 9. TABLE IV - ZERO | | | | 11. PHASE 1 - DAY FIRE | | | | | 12. PHASE 2 - NIGHT | | | | | 13. RATING CALCULATOR | | | | | | |
| AIMING DEVICE | GO | NO GO | N/A | TGT | M110 RANGE (m) | M2010 RANGE (m) | M107 RANGE (m) | HIT 1st | HIT 2nd | POINTS | TGT | M110 RANGE (m) | M2010 RANGE (m) | M107 RANGE (m) | HIT 1st | HIT 2nd | POINTS | PHASE 1 TOTAL POINTS: | 90 | |
| BUIS | <input type="checkbox"/> | <input type="checkbox"/> | <input checked="" type="checkbox"/> | 1 | 500 | 500 | 800 | <input checked="" type="checkbox"/> | <input type="checkbox"/> | 10 | 1 | 200 | 200 | 600 | <input checked="" type="checkbox"/> | <input type="checkbox"/> | 10 | PHASE 2 TOTAL POINTS: | 100 | |
| OPTIC | <input checked="" type="checkbox"/> | <input type="checkbox"/> | <input type="checkbox"/> | 2 | 800 | 800 | 400 | <input checked="" type="checkbox"/> | <input type="checkbox"/> | 10 | 2 | 100 | 100 | 400 | <input checked="" type="checkbox"/> | <input type="checkbox"/> | 10 | TOTAL TABLE POINTS: | 190 | |
| TWS | <input type="checkbox"/> | <input type="checkbox"/> | <input checked="" type="checkbox"/> | 3 | 600 | 600 | 900 | <input checked="" type="checkbox"/> | <input type="checkbox"/> | 10 | 3 | 300 | 300 | 900 | <input checked="" type="checkbox"/> | <input type="checkbox"/> | 10 | 14. SNIPER TEAM POSITION (CHECK ONE) | | |
| IR POINTER | <input checked="" type="checkbox"/> | <input type="checkbox"/> | <input type="checkbox"/> | 4 | 400 to 600 | 400 to 600 | 600 to 800 | <input checked="" type="checkbox"/> | <input type="checkbox"/> | 10 | 4 | 400 to 600 | 400 to 600 | 600 to 800 | <input checked="" type="checkbox"/> | <input type="checkbox"/> | 10 | SNIPER | <input type="checkbox"/> | |
| UNIVERSAL NIGHT SIGHT | <input type="checkbox"/> | <input type="checkbox"/> | <input checked="" type="checkbox"/> | 5 | 400 to 600 | 400 to 600 | 1200 to 1300 | <input checked="" type="checkbox"/> | <input type="checkbox"/> | 10 | 5 | 400 to 600 | 400 to 600 | 1200 to 1300 | <input checked="" type="checkbox"/> | <input type="checkbox"/> | 10 | SPOTTER | <input type="checkbox"/> | |
| 10. ZERO DATA NOTES: | | | | 6 | 500 to 700 | 500 to 700 | 1400 to 1600 | <input checked="" type="checkbox"/> | <input type="checkbox"/> | 10 | 6 | 500 to 700 | 500 to 700 | 1400 to 1600 | <input checked="" type="checkbox"/> | <input type="checkbox"/> | 10 | TEAM LEADER | <input type="checkbox"/> | |
| 16. REMARKS | | | | 7 | 600 to 800 | 600 to 800 | 1200 to 1300 | <input type="checkbox"/> | <input checked="" type="checkbox"/> | 5 | 7 | 600 to 800 | 600 to 800 | 1200 to 1300 | <input checked="" type="checkbox"/> | <input type="checkbox"/> | 10 | 15. QUALIFICATION RATING | | |
| | | | | 8 | 300 to 500 | 300 to 500 | 1400 to 1600 | <input checked="" type="checkbox"/> | <input type="checkbox"/> | 10 | 8 | 300 to 500 | 300 to 500 | 1400 to 1600 | <input checked="" type="checkbox"/> | <input type="checkbox"/> | 10 | 180-200 | <input checked="" type="checkbox"/> | EXPERT |
| | | | | 9 | 400 to 600 | 800 to 1000 | 1200 to 1400 | <input checked="" type="checkbox"/> | <input type="checkbox"/> | 10 | 9 | 400 to 600 | 800 to 1000 | 1200 to 1400 | <input checked="" type="checkbox"/> | <input type="checkbox"/> | 10 | 160-179 | <input type="checkbox"/> | SHARPSHOOTER |
| | | | | 10 | 600 to 800 | 800 to 1000 | 1400 to 1600 | <input type="checkbox"/> | <input checked="" type="checkbox"/> | 5 | 10 | 600 to 800 | 800 to 1000 | 1400 to 1600 | <input checked="" type="checkbox"/> | <input type="checkbox"/> | 10 | 140-159 | <input type="checkbox"/> | MARKSMAN |
| | | | | | | | | PHASE 1 TOTALS | | | | | PHASE 2 TOTALS | | | | | | | |
| | | | | 90 | | | | | 100 | | | | | | | | | | | |
| LEGEND: DOD ID No. - Department of Defense Identification Number; m - meters; OIC - officer-in-charge; TGT - target; N/A - not applicable; BUIS - back up iron sight; TWS - thermal weapon sight; IR - infrared | | | | | | | | | | | | | | | | | | | | |
| 17. RANGE OIC PRINTED NAME AND RANK WILSON, JAMES Y. 1LT | | | | 18. RANGE OIC SIGNATURE WILSON, JAMES Y. 1234567890 | | | | 19. CERTIFYING OFFICIAL SIGNATURE (COMMANDER) Williams, Noah K. 1456789023 | | | | FOR OFFICIAL USE ONLY | | | | | | | | |

Figure B-13. Completed DA Form 7811 (Sniper Scorecard) example

DA FORM 7819, URBAN MARKSMANSHIP SCORECARD

B-23. The trainer uses the DA Form 7819, (*Urban Marksmanship Scorecard*), (see figure B-14, on page B-22) to record the firer’s performance on Tables V, Practice and VI, Certification. Go to the APD website found in the references section at the back of this manual for a downloadable / printable copy. This form is one page.

B-24. The Soldier or first line leader uses blocks 1 through 8 to enter administrative information. Blocks 9 through 13 are used by the lane safety or designated NCO to score and record firing information. Block 12 displays the firer’s certification rating. Blocks 14 and 15 are used by the range OIC to verify the completeness and accuracy of the information on the scorecard. Block 16 is used by the unit commander to certify the qualification status and rating of the team.

- Block 1- The Soldier or leader enters the fires name.
- Block 2- The Soldier or leader enters the fires rank.
- Block 3- The Soldier or leader enters the fires DODID Number.
- Block 4- The Soldier or leader enters the date fringing took place.
- Block 5- The Soldier or leader enters the lane and firing order the Soldier fired in.
- Block 6- The Soldier or leader enters the weapon type (M4 / M16 / M249AR).
- Block 7- The Soldier or leader enters the equipment and/or optic used during the firing events.
- Block 8- The Soldier or leader checks the appropriate table box for either practice or certification.
- Block 9- Lane safeties or designated NCOs, assigned as lane scorers, write the total number of hits that impact inside zone 5 of the B7 target. All rounds must impact inside of zone 4. Any rounds impacting outside of zone 4 or 5 results in an uncertified rating. The scorer calculates the total the number of hits and records the number at the bottom of the second column under Phase I, Day Fire.

- Block 10- Lane safeties or designated NCOs, assigned as lane scorers, write the total number of hits that impact inside zone 5 of the B7 target. All rounds must impact inside of zone 4. Any rounds impacting outside of zone 4 or 5 results in an uncertified rating. The scorer calculates the total the number of hits and records the number at the bottom of the second column under Phase II, Night Fire
- Block 11- The scorer transfers the information from phase I and phase II and calculates the sum of the two phases.
- Block 12- The scorer uses the total from the previous block to determine the certification rating for the appropriate weapon type.
- Block 13- Lane safeties or designated NCOs, assigned as lane scorers, enter any necessary remarks pertaining to firer's performance.
- Block 14- The range OIC enters their full name, printed, and their rank into this block.
- Block 15- The range OIC signs this block.
- Block 16- The commander of the firers unit signs this block certifying the Soldier has completed the table.

| URBAN MARKSMANSHIP SCORECARD | | | | | | | | | | | | | | | |
|--|----------------------|-----------|-------------------------------------|---|------------------------|---------------|-------------------------------------|---|----------------------|-----------|-------------------------------------|--|------------------------|---------------|-------------------------------------|
| For use of this form, see TC 3-20.40; the proponent agency is TRADOC. | | | | | | | | | | | | | | | |
| 1. NAME (LAST, FIRST, MI) MILLER, WILLIAM U. | | | | 2. RANK SFC | | | | 3. DOD ID No. 1345678902 | | | | 4. DATE (YYYYMMDD) 20190802 | | | |
| 5. LANE/FIRING ORDER 1 / FO 1 | | | | 6. WEAPON TYPE M4A1 | | | | 7. EQUIPMENT/OPTICS M68 | | | | 8. TABLE NUMBER (CHECK ONE) TABLE V <input type="checkbox"/> PRACTICE TABLE VI <input checked="" type="checkbox"/> CERTIFICATION | | | |
| 9. PHASE 1 DAY FIRE | | | | | | | | 10. PHASE 2 NIGHT FIRE | | | | | | | |
| ENG | CONDITIONS | RANGE (m) | HIT | ENG | CONDITIONS | RANGE (m) | HIT | ENG | CONDITIONS | RANGE (m) | HIT | ENG | CONDITIONS | RANGE (m) | HIT |
| 1 | STRAIGHT AHEAD | 5 | <input checked="" type="checkbox"/> | 6 | STRAIGHT AHEAD | 25 | <input type="checkbox"/> | 1 | STRAIGHT AHEAD | 5 | <input checked="" type="checkbox"/> | 6 | STRAIGHT AHEAD | 25 | <input type="checkbox"/> |
| 2 | LEFT TURN | 10 | <input checked="" type="checkbox"/> | 7 | RUN, STOP, AND SHOOT | FROM 25 TO 20 | <input type="checkbox"/> | 2 | LEFT TURN | 10 | <input checked="" type="checkbox"/> | 7 | RUN, STOP, AND SHOOT | FROM 25 TO 20 | <input checked="" type="checkbox"/> |
| 3 | RIGHT TURN | 10 | <input checked="" type="checkbox"/> | 8 | RUN, STOP, AND SHOOT | FROM 20 TO 15 | <input checked="" type="checkbox"/> | 3 | RIGHT TURN | 10 | <input checked="" type="checkbox"/> | 8 | RUN, STOP, AND SHOOT | FROM 20 TO 15 | <input checked="" type="checkbox"/> |
| 4 | WALK LATERALLY RIGHT | 10 | <input checked="" type="checkbox"/> | 9 | TARGET TO REAR | 15 | <input checked="" type="checkbox"/> | 4 | WALK LATERALLY RIGHT | 10 | <input checked="" type="checkbox"/> | 9 | TARGET TO REAR | 15 | <input checked="" type="checkbox"/> |
| 5 | WALK LATERALLY LEFT | 10 | <input checked="" type="checkbox"/> | 10 | WALKING STRAIGHT AHEAD | FROM 15 TO 10 | <input checked="" type="checkbox"/> | 5 | WALK LATERALLY LEFT | 10 | <input type="checkbox"/> | 10 | WALKING STRAIGHT AHEAD | FROM 15 TO 10 | <input checked="" type="checkbox"/> |
| PHASE 1: DAY TOTALS | | | | | | | | PHASE 2: NIGHT TOTALS | | | | | | | |
| 11. TABLE TOTALS | | | | 12. RATING | | | | 13. REMARKS | | | | SM fired Table VI in full kit. | | | |
| PHASE 1: HITS | | 8 | | PHASE 1 | | PHASE 2 | | <input checked="" type="checkbox"/> CERTIFIED | | | | | | | |
| PHASE 2: HITS | | 8 | | 7 - 10 | | 7 - 10 | | <input type="checkbox"/> UNCERTIFIED | | | | | | | |
| TOTAL SCORE: (Phase 1 and 2) | | 16 | | < 7 | | < 7 | | *Range OIC must digitally sign first. | | | | | | | |
| LEGEND: DOD ID No. - Department of Defense Identification Number; OIC - officer-in-charge; ENG - engagement; m - meters. | | | | | | | | | | | | | | | |
| 14. RANGE OIC PRINTED NAME AND RANK WILSON, JAMES Y. 1LT | | | | 15. RANGE OIC SIGNATURE WILSON, JAMES Y. 1234567890 | | | | 16. CERTIFYING OFFICIAL SIGNATURE (COMMANDER) Williams, Noah K. 1456789023 | | | | | | | |

Figure B-14. Completed DA Form 7819 (Urban Marksmanship Scorecard) example

This page intentionally left blank.

Appendix C

Weapons Safety

This appendix describes safe weapons handling, the rules of firearms safety, WSS, and weapon control measures. Each weapons safety topic is directly related to the execution of training and tactical employment. It is the leaders' responsibility to instill weapons safety responsibility and accountability in their Soldier's use, care, and employment of their assigned weapons.

To conduct ranges safely and efficiently, while simultaneously ingraining respect for the weapon and its inherent role in the Army, leaders must instruct, educate, and reinforce weapons safety routinely. Each Soldier must understand how to apply the safe weapons handling practices as they pertain to a Soldier's weapon. This includes a comprehensive understanding of the unit's established ROE, as well as the ethical employment of arms.

WEAPONS SAFETY

C-1. All weapons inherently injure, maim, or kill indiscriminately. It is imperative that Soldiers are aware of the importance of safe weapons / munitions handling.

SAFE WEAPONS HANDLING

C-2. Safe weapons handling procedures offer a standardized method for Soldiers to handle, operate, and employ the weapon safely and effectively. Weapons handling is built on three components—the Soldier, the weapon, and the environment described below:

- The Soldier must maintain situational understanding of friendly forces, the status of the weapon, and the environment to handle the weapon properly. The smart, adaptive, and disciplined Soldier is the primary safety mechanism for all weapons under their control.
- The weapon is the primary tool the Soldier uses to defeat threats in combat. The Soldier must know how to operate the mechanical safeties built into the weapons they employ, as well as the principles of operation.
- The environment is the Soldier's surroundings and mindset. The Soldier must be aware of muzzle discipline, the nature of the target, and what is behind the target. Threats commonly mix with noncombatants, so the Soldier needs to be able to tell the difference quickly.

C-3. Soldiers must be cognitively aware of three distinct weapons handling measures to handle weapons safely and effectively. The weapons handling measures are:

- Rules of firearms safety.
- Weapon safety status.
- Weapons control status.

RULES OF FIREARMS SAFETY

C-4. The rules of firearms safety are standardized for any weapon a Soldier may employ or handle. Soldiers must adhere to these precepts during training and combat operations, regardless of the type of ammunition they are using.

RULE 1: TREAT EVERY WEAPON AS IF IT WERE LOADED

C-5. Soldiers must treat every weapon they handle as if it is loaded and prepared to fire. Whether or not a weapon is loaded should not affect how a Soldier handles the weapon in any instance. Soldiers must take the appropriate actions to ensure they apply the proper weapon status during operations, whether in combat or training.

RULE 2: NEVER POINT THE WEAPON AT ANYTHING YOU DO NOT INTEND TO SHOOT

C-6. Soldiers must be aware of the orientation of their weapon's muzzle and the path of the projectile if the weapon fires. Soldiers must ensure the path between the muzzle and target is clear of friendly forces, noncombatants, or anything the Soldier does not want to strike.

C-7. When this is unavoidable, the Soldier must minimize the amount of time the muzzle is oriented toward people or objects they do not intend to shoot while simultaneously applying the other three rules of firearms safety.

RULE 3: KEEP FINGER STRAIGHT AND OFF THE TRIGGER UNTIL READY TO FIRE

C-8. Soldiers must not place their finger on the trigger unless they intend to fire the weapon. The Soldier is the most important safety feature on any weapon. Soldiers must not solely rely upon mechanical safeties for safe operation. Whenever possible, Soldiers should move the weapon to mechanical safe when a target is not present.

RULE 4: ENSURE POSITIVE IDENTIFICATION OF THE TARGET AND ITS SURROUNDINGS

C-9. The disciplined Soldier can positively identify the target and knows what is in front of and what is beyond it. The Soldier is responsible for all bullets fired from their weapon including the projectile's final destination. Application of this rule minimizes the possibility of fratricide, collateral damage, or damage to infrastructure or equipment. It also prepares the Soldier for any follow-on shots or bursts that may be required.

WEAPONS SAFE EMPLOYMENT





C-10. Leaders and Soldiers are responsible for ensuring the safe handling and employment of their assigned weapons and munitions. WSS and weapons control status provide the Soldier and leader with the Army standard for safe employment and handling of weapons and munitions.

WEAPON SAFETY STATUS

C-11. WSS is a standard code that uses common colors (green, amber, red, and black) to represent the level of safety for a given weapon. Each color represents a specific series of actions that are applied to a weapon to place it in a specific level of safety. The colors are used in training and combat to place or maintain a level of safety relevant to the current task or action of a Soldier, small unit, or group. The standard color code is applicable to all weapons; the pistol, M4 / M16 / sniper weapons, and the M249 automatic rifle are described in detail below.

C-12. The WSS ratings are evaluated by the level of safety measures applied to the weapon itself. Table C-1 describes the general safe condition of the weapon for each WSS, based on the standard color scheme found in ADP 1-02.

Table C-1. General safe condition of the weapon for each weapons safety status

| Weapon Safety Status | General Description | Color Amplifier |
|----------------------|---------------------|---|
| GREEN | Fully Safe |  |
| AMBER | Substantially Safe |  |
| RED | Marginally Safe |  |
| BLACK | Not Safe |  |

C-13. All firers and leaders must be fluent in the general meaning of each WSS, how it pertains to the weapon being employed, and the responsibilities of the firer to own each shot or burst. The following are the basic definitions for each WSS:

- Green, Fully safe – the weapon is clear, no ammunition is present (no magazine or belt), the chamber is empty, and the weapon is on safe. All weapons have an individual task to “clear weapon.”
- Amber, Substantially safe – a leader must clear and verify that the weapon’s bolt or slide is forward, the chamber is empty, and ammunition is introduced to the weapon. This is an administrative or preparatory WSS. Leaders use amber primarily for mounted weapons and during combat operations when directed to maintain a substantially safe weapon with the ability to rapidly transition and escalate to red or black, based on the situation.

Note. WSS amber is not used in the live-fire events described in this publication.

- Red, Marginally safe – the weapon is on safe, the magazine is locked in the well or the belted ammunition is on the feed tray with the cover closed. For pistols, rifles, carbines, and sniper weapon systems, a round is in the chamber and the bolt is forward in the locked position. For the M249AR, the bolt is locked to the rear, with the ammunition on the feed tray with the cover closed.
- Black, Not safe – indicates when the weapon is fully prepared to fire, the firer has positively identified the target, the weapon is on FIRE, and the firer’s finger is on the trigger, and is in the process of engaging the threat.

C-14. WSS black is used to describe the actions of the firer when in a red status and entering an engagement sequence. WSS black describes the clear difference between red and actively and deliberately engaging a threat.

PISTOL

C-15. Figures C-1 through C-4, on pages C-4 through C-7, describe the standard color code for the pistol. The Soldier takes the actions described in figures C-1 through C-4 to move from one color code to the next.

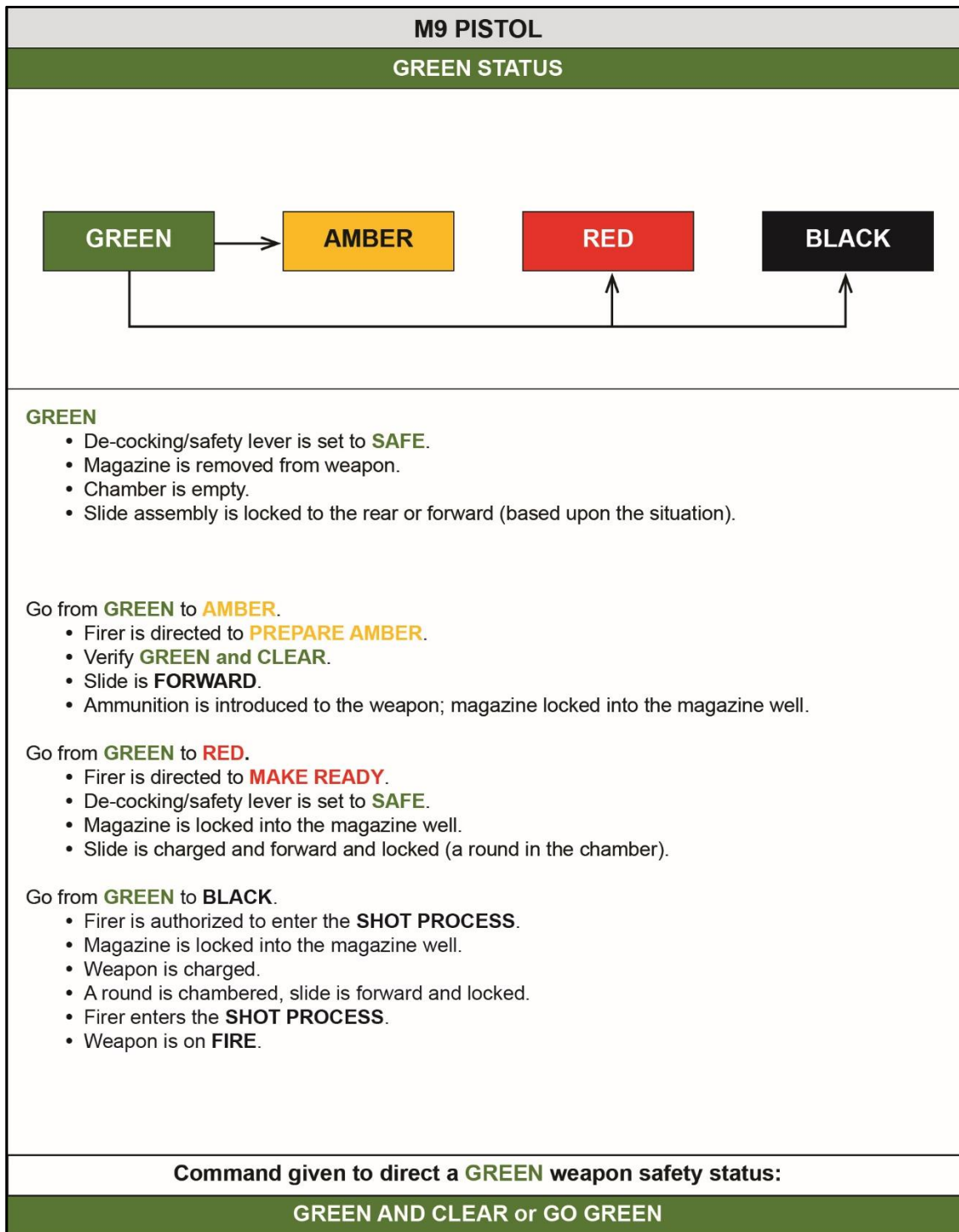

Figure C-1. Pistol, green weapon safety status

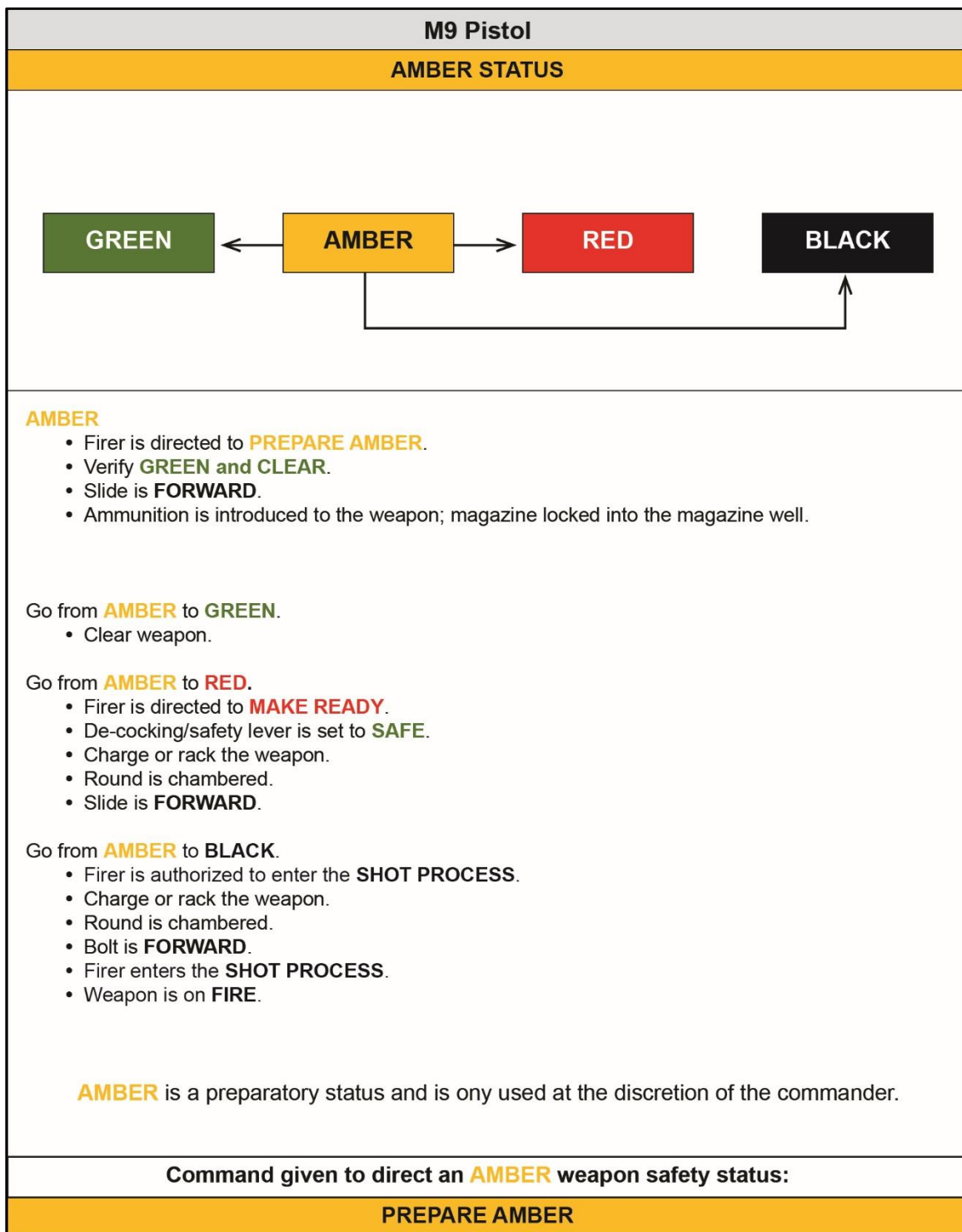

Figure C-2. Pistol, amber weapon safety status



Figure C-3. Pistol, red weapon safety status

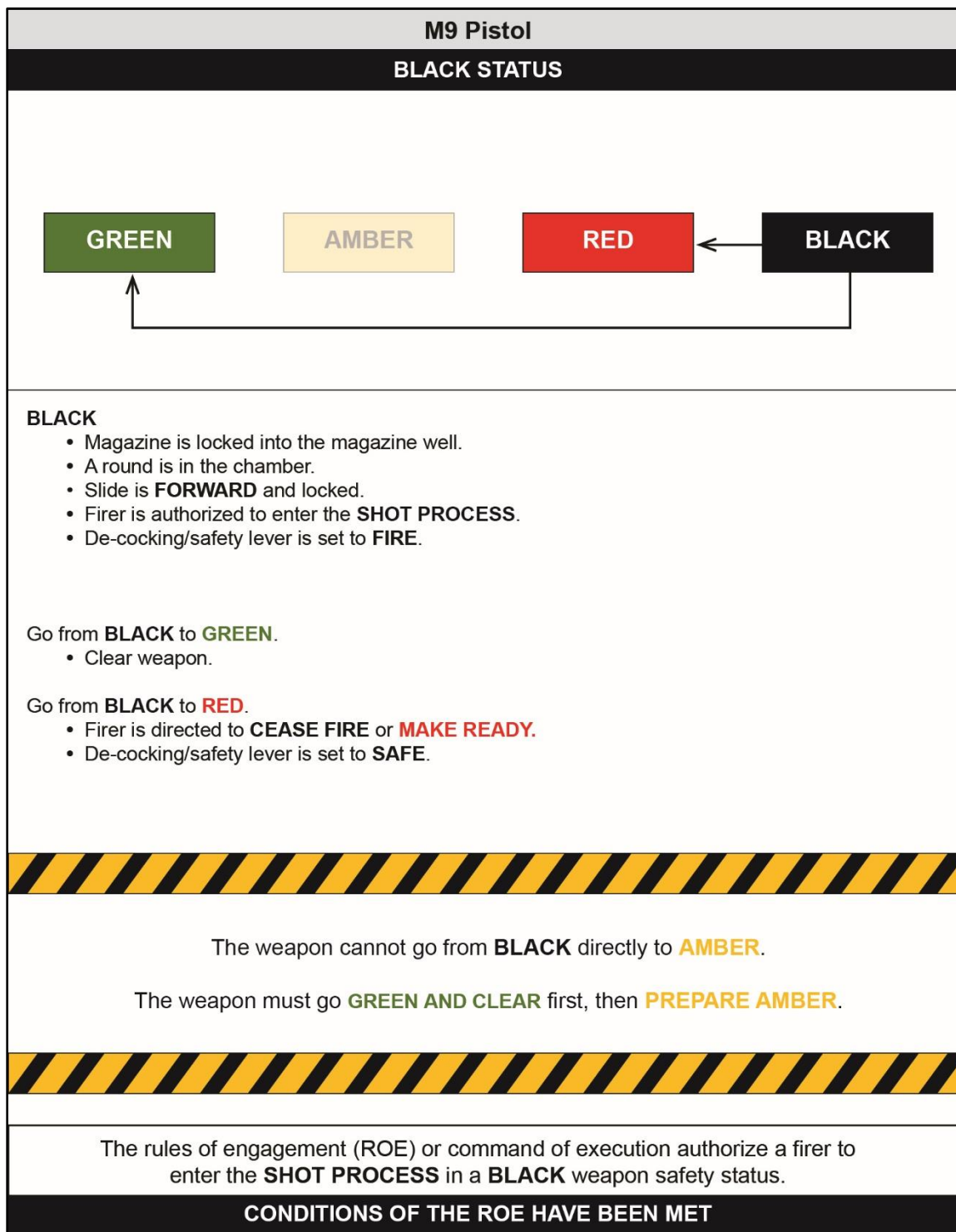

Figure C-4. Pistol, black weapon safety status

M4 / M16 / SNIPER WEAPON SYSTEM

C-16. Figures C-5 through C-8, on pages C-8 through C-11, describe the standard color code for the M4, M16, and sniper weapon system WSS. The Soldier takes the actions described in figures C-5 through C-8, on pages C-8 through C-11, to move from one color code to the next.

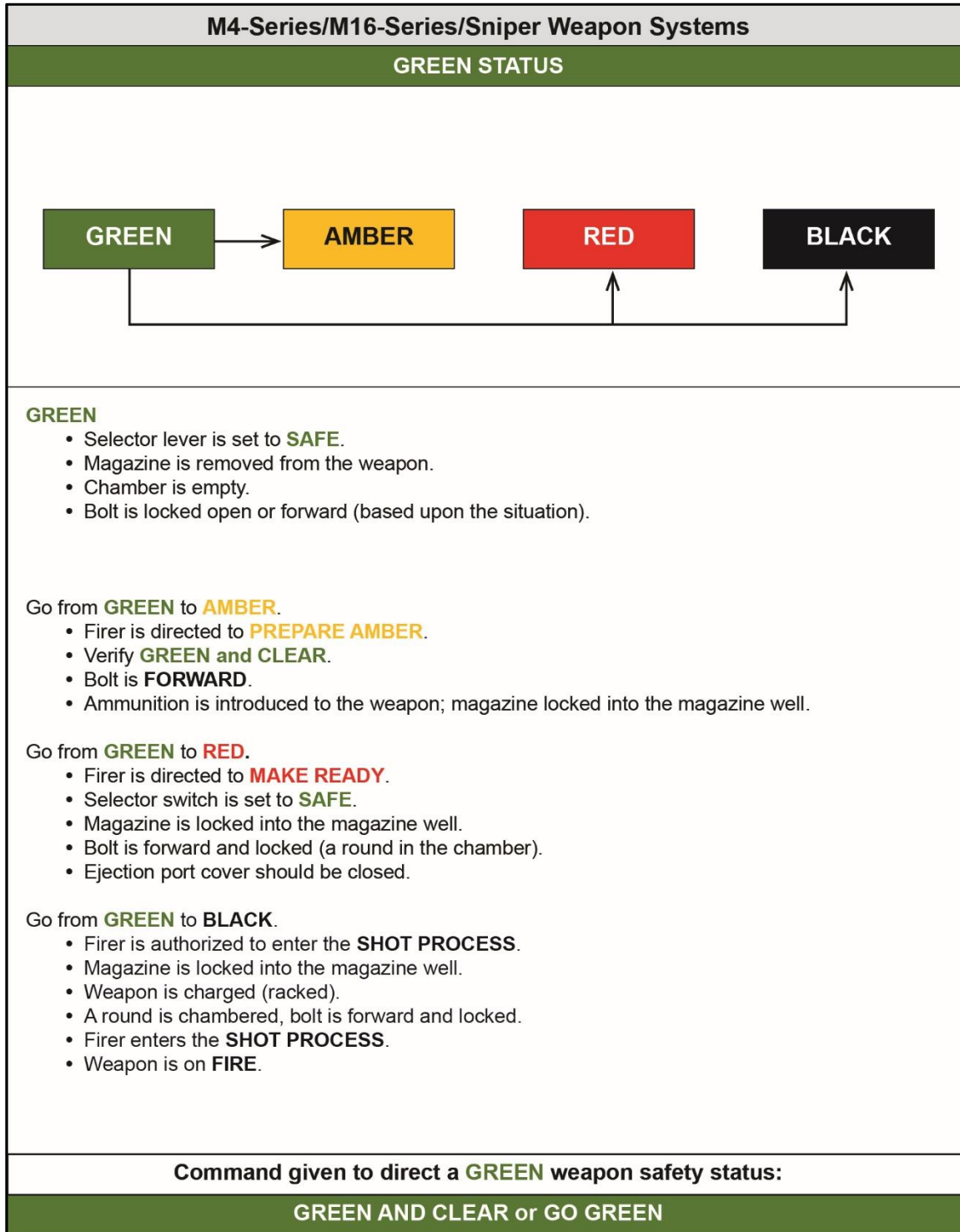

Figure C-5. M4- / M16-series / sniper weapons, green weapon safety status

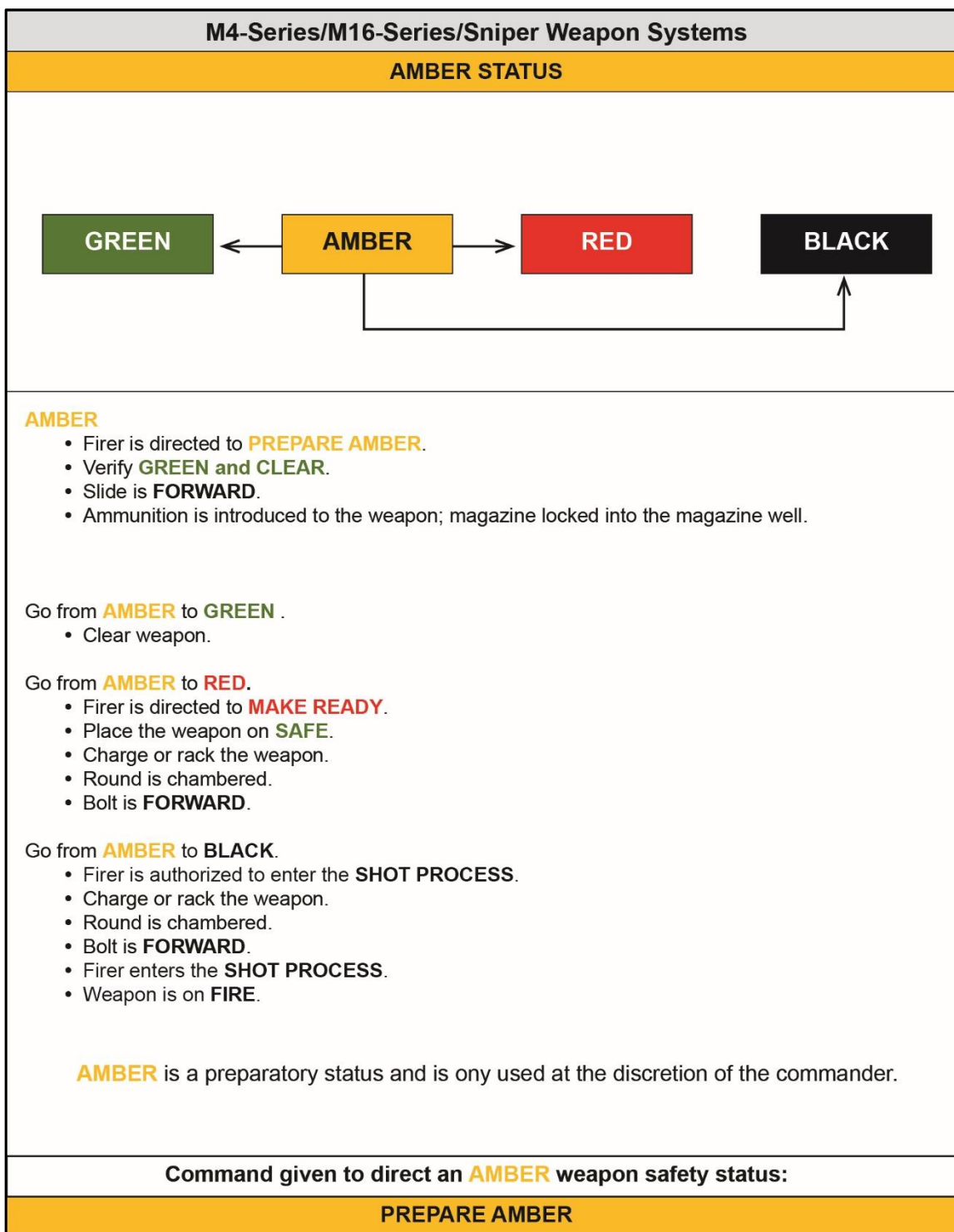

Figure C-6. M4- / M16-series / sniper weapons, amber weapon safety status

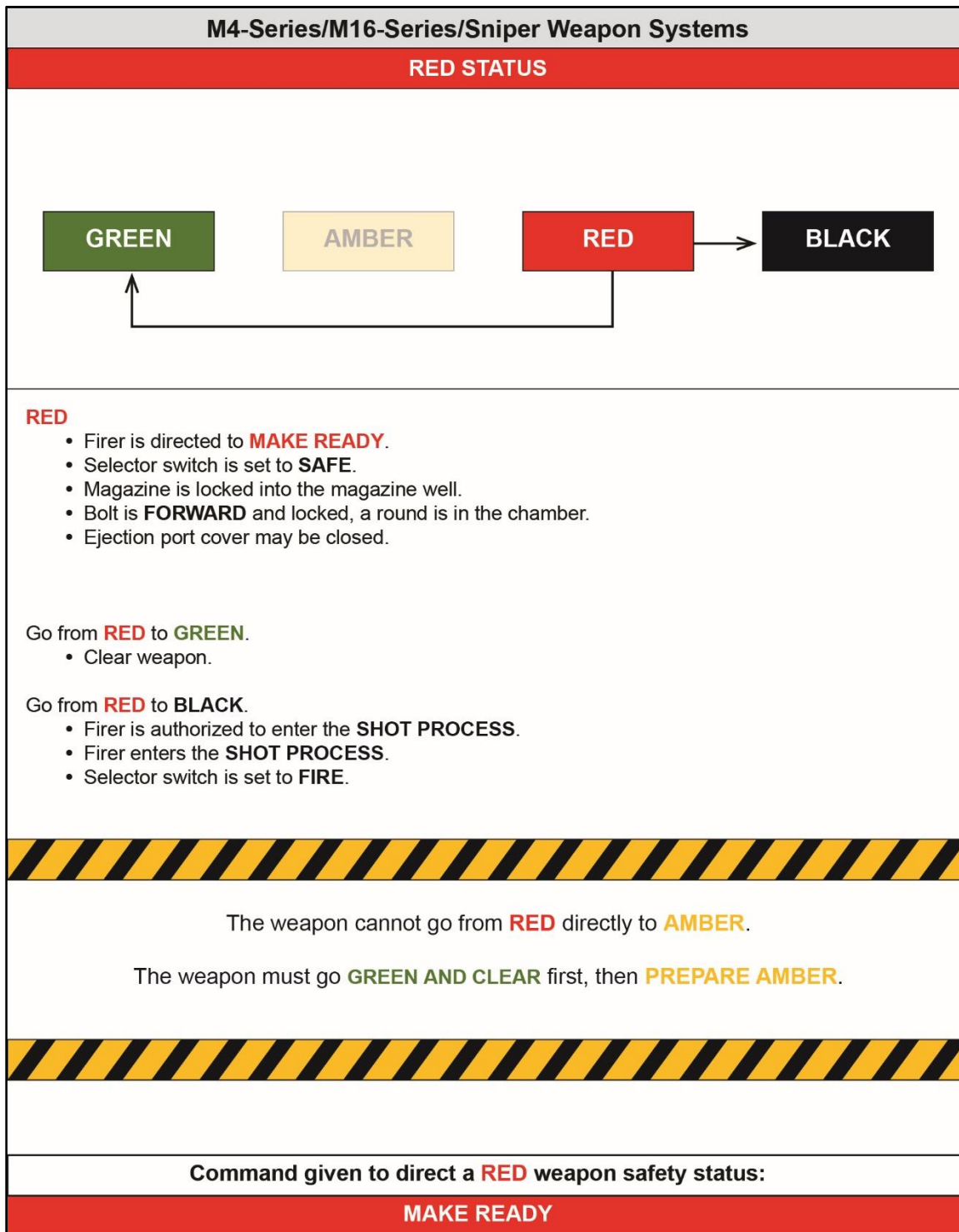

Figure C-7. M4- / M16-series / sniper weapons, red weapon safety status

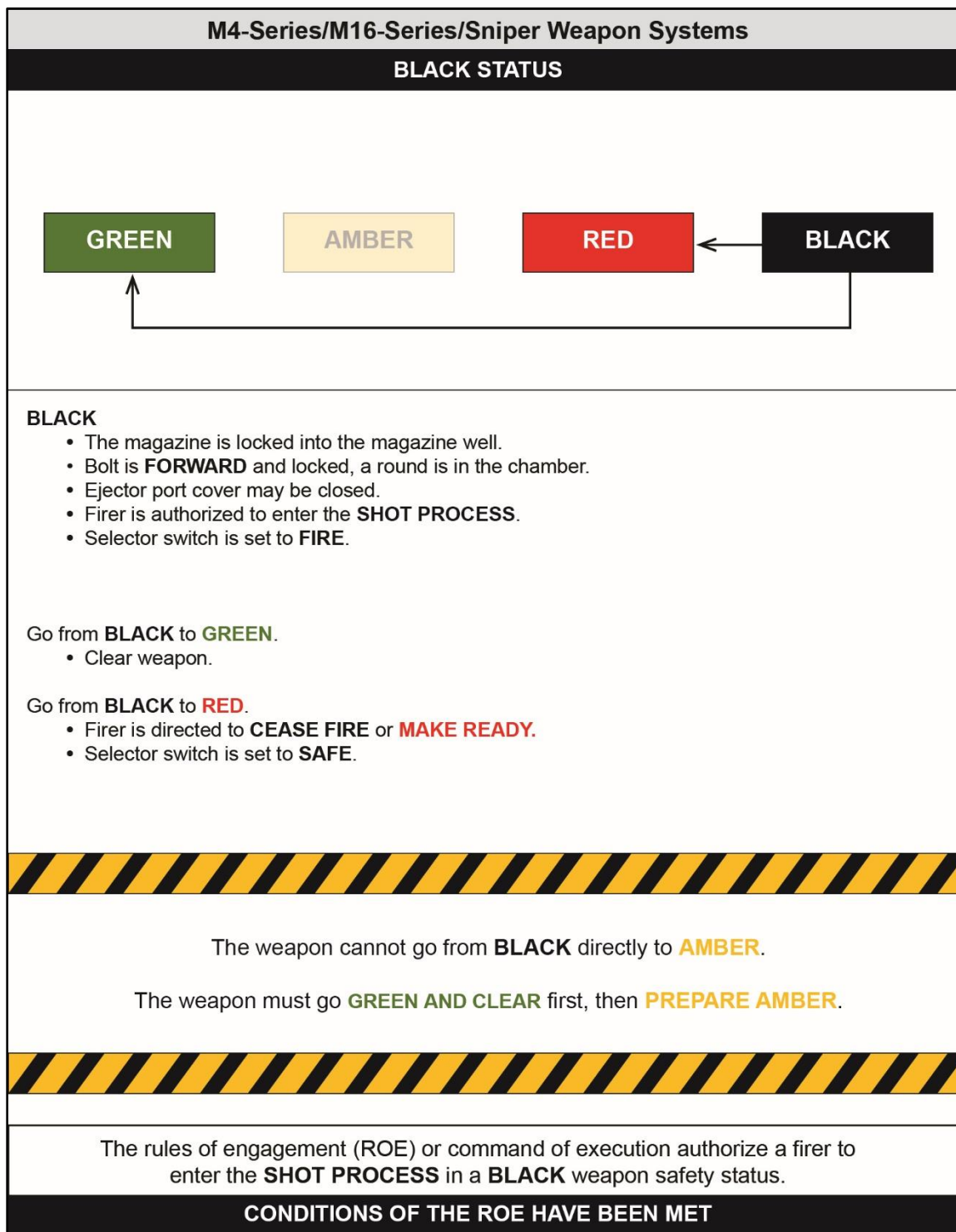

Figure C-8. M4- / M16-series / sniper weapons, black weapon safety status

M249 AUTOMATIC RIFLE

C-17. Figures C-9 through C-12, on pages C-12 through C-15, describe the standard color code for the M249 automatic rifle WSS. The Soldier takes the actions described in figures C-9 through C-12, on pages C-12 through C-15, to move from one color code to the next.

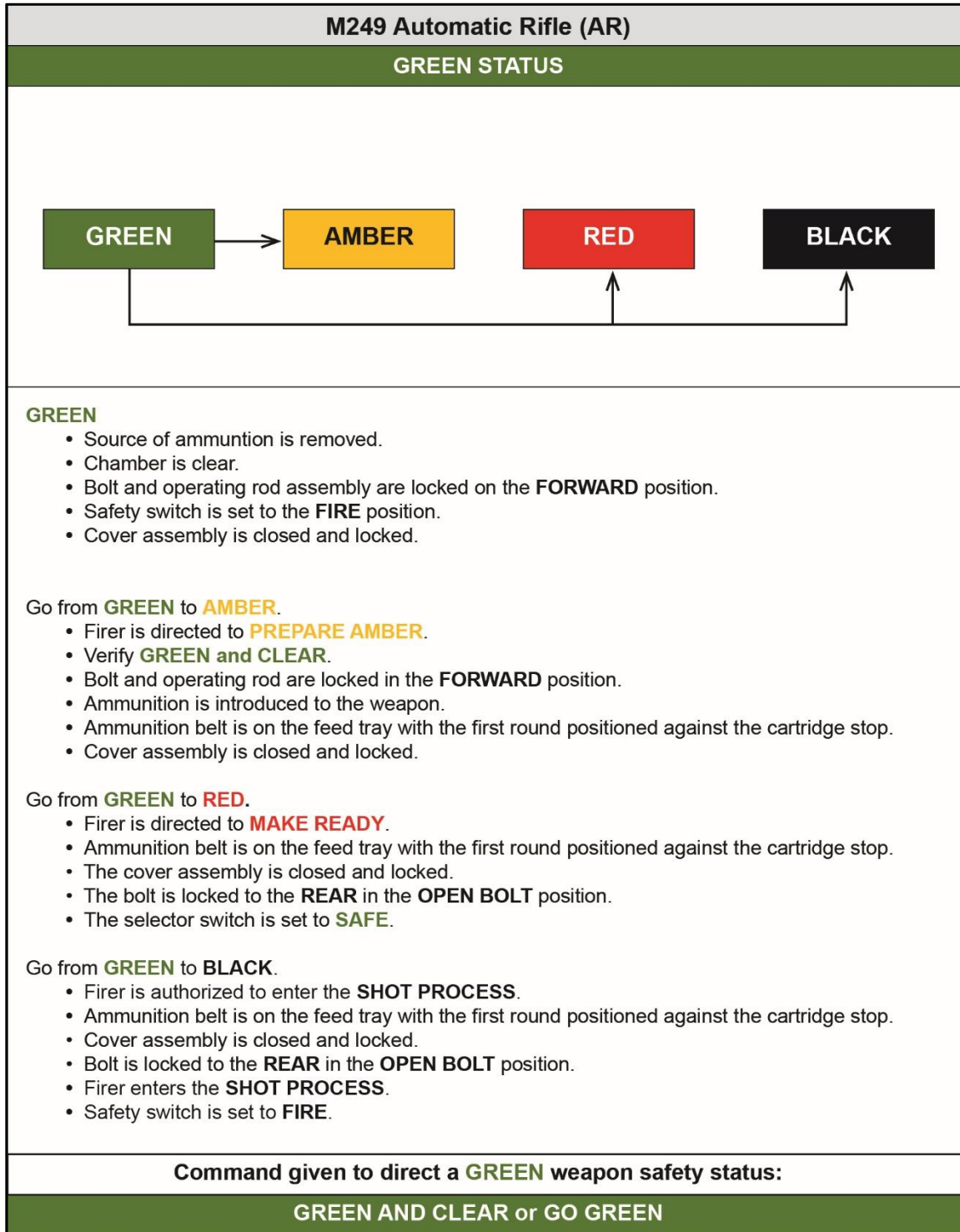

Figure C-9. M249 automatic rifle, green weapon safety status

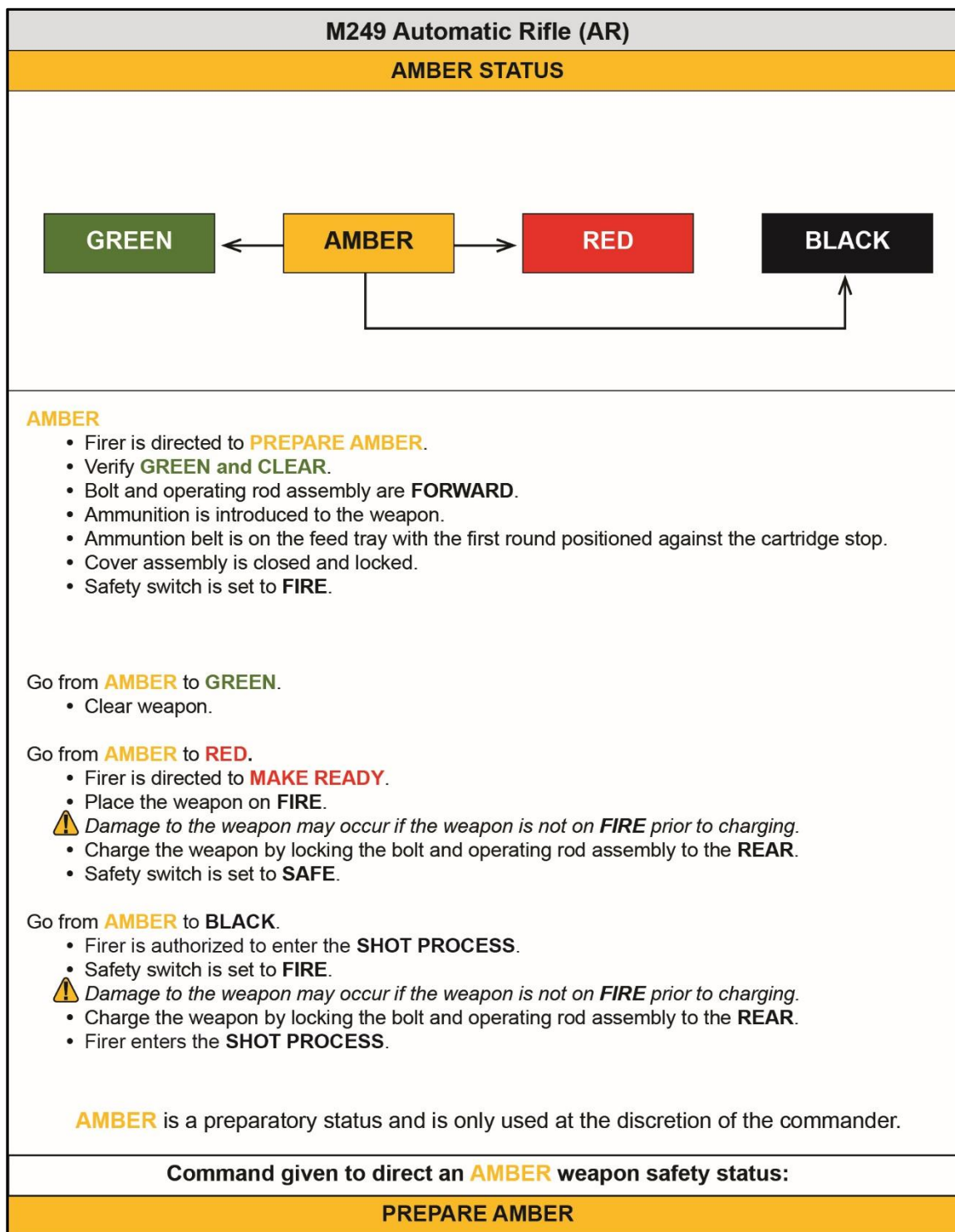

Figure C-10. M249 automatic rifle, amber weapon safety status

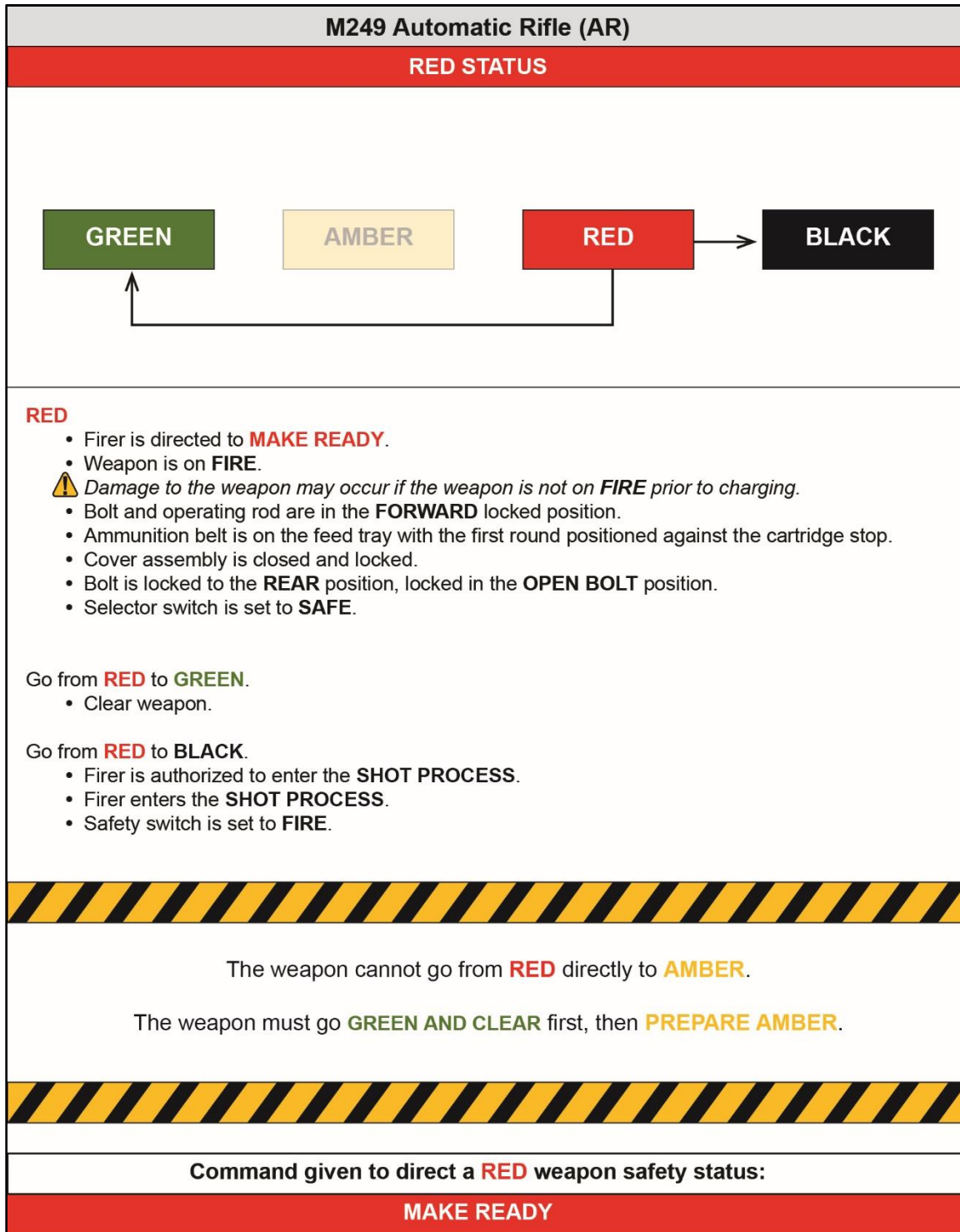

Figure C-11. M249 automatic rifle, red weapon safety status

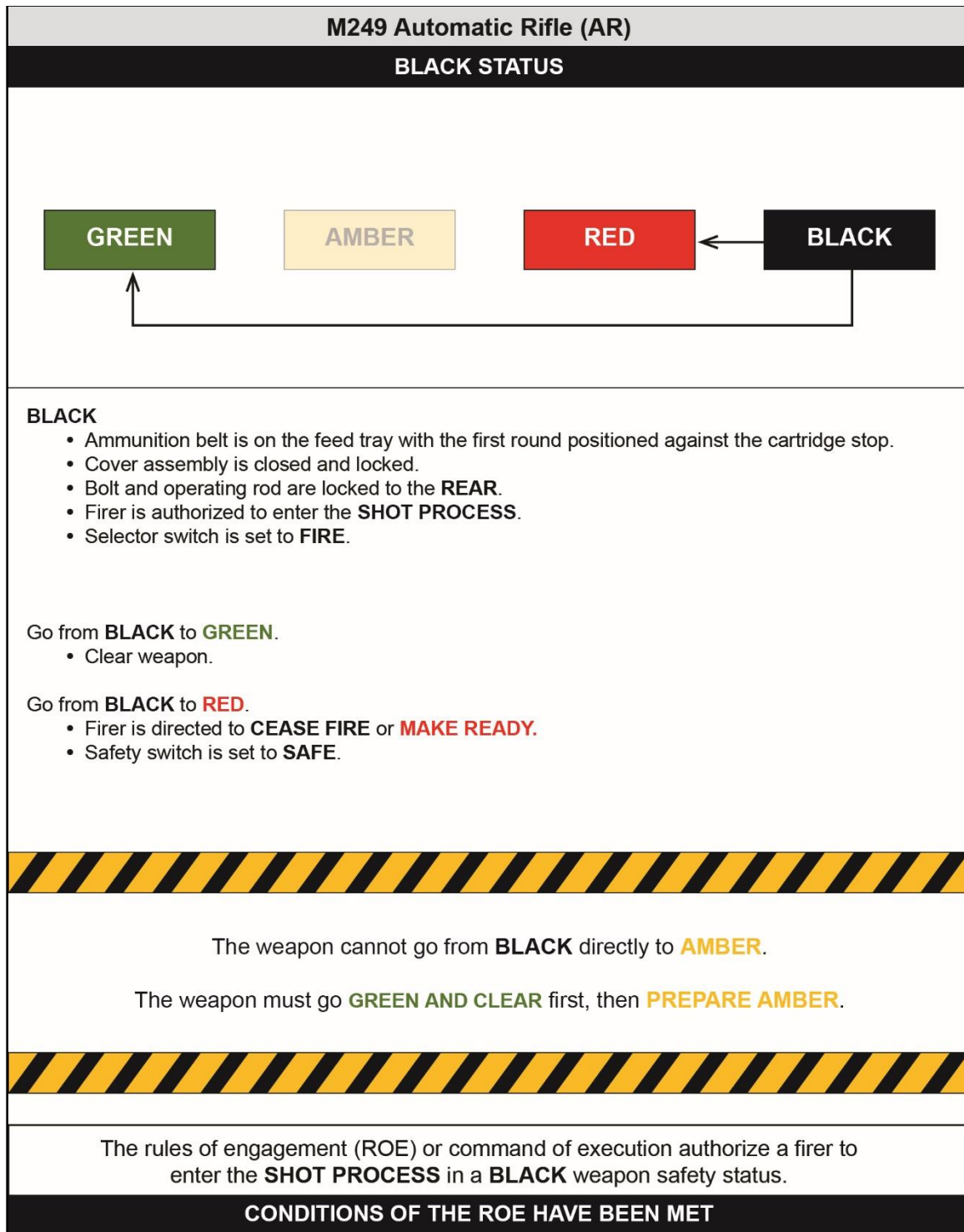

Figure C-12. M249 automatic rifle, black weapon safety status

WEAPON CONTROL STATUS

C-18. A weapon control status is a tactical method of fire control given by a leader. The weapon control status incorporates the tactical situation, ROE for the area of operations, and expected or anticipated enemy contact. The weapon control status outlines the target identification conditions under which friendly elements may engage a perceived threat with direct fire.

C-19. Table C-2 describes the standard weapon control status used in tactical operations, in training and combat. Table C-2 describes when the gunner has authorization to engage a threat target once they have met the threat conditions.

Table C-2. Weapon control status

| Weapon Control Status | Definition |
|------------------------------|--|
| Weapons hold | Engage only if engaged or ordered to engage. |
| Weapons tight | Engage only if target is positively identified as enemy. |
| Weapons free | Engage targets not positively identified as friendly. |

C-20. Both a weapon control and a WSS are implemented and available to leaders to prevent fratricide and limit collateral damage. Leaders develop these postures or statuses for a particular area of operations or type of mission. Leaders should clearly outline both for all Soldiers, usually in the OPORD, WARNORD, or FRAGORD.

Appendix D

Pistol

This appendix describes the Army-standard pistol strategy events for training through qualification for all Soldiers assigned the M9-, M17-, or M18-series pistols. Once successfully completed, Soldiers are qualified to progress to higher levels of marksmanship training or certification, and to use the weapon during any future collective live-fire training events within the qualification period.

This appendix provides an overview of the qualification standards. It provides a snapshot to commanders of the Army’s requirement to achieve and sustain a level of weapons proficiency for their Soldiers assigned a pistol. Soldiers assigned multiple weapons and executing the pistol training strategy must also be qualified on their primary assigned individual weapon and equipment within the past qualification period based on the commanders master authorization list (known as MAL).

PISTOL TRAINING STRATEGY

D-1. The standard IWTS lists six tables of training events. Each table’s events are explained with all associated resources required; ranges, simulators, simulations, ammunition, and time, as appropriate. This has a section for each training event within the weapon’s strategy, as well as CBRN, night requirements, and an authorized alternative course of fire. Each section describes the necessary information to plan, prepare, execute, and assess each training event. Companies executing the training events apply the eight-step training model, as appropriate.

D-2. Table D-1 shows the pistol training strategy through qualification. It provides the sequence of training events, the days required, and the training time remaining to achieve live-fire proficiency.

Table D-1. Individual weapons training strategy structure

| Pistol | <i>Table I, PMI&E</i> | <i>Table II, PLFS</i> | <i>Table III, Drills</i> | <i>Table IV, Basic</i> | <i>Table V, Practice</i> | <i>Table VI, QUAL</i> | |
|--|-------------------------------|---------------------------|------------------------------|----------------------------|------------------------------|---------------------------|----------|
| | | | Night | | | | Day |
| | | | CBRN | | | | Night* |
| | | | | | | | CBRN* |
| | | PRQ | PRQ | PRQ | REQUIRED | | REQUIRED |
| Days Required | 0.5 | 0.5 | 0.5 | 1.0 | 1.0 | 1.0 | |
| Legend: *Conducted live-fire when simulator not available, CBRN – chemical, biological, radiological, nuclear, PLFS – preliminary live-fire simulation, PRQ – prerequisite, PMI&E – preliminary marksmanship instruction and evaluation, QUAL – qualification | | | | | | | |

D-3. Table D-2, on page D-2, illustrates the ammunition required for the pistol training strategy through. Table D-2 includes the associated weapons by line item number (known as LIN) and NSN, all training munitions including DDI requirements, and the live-fire training ammunition requirements.

D-4. The numbers replicate the amount of ammunition each firer is authorized to complete one complete iteration of each event in the training strategy through qualification. The munitions listed below do not include any retraining, cross-training, demonstration munitions, or collective training requirements.

D-5. Units with access to an approved simulator system are not resourced training ammunition for those tasks. Units with access to approved systems complete the night and CBRN qualification requirements in the authorized system only. Units without access to an approved simulator system conduct the night and CBRN qualifications live, under live-fire conditions at the completion of Table VI, Qualification.

Table D-2. Pistol individual weapon training strategy ammunition requirements

| <i>DODIC</i> | <i>Munition Type</i> | <i>Table III, DRILLS</i> | <i>Table IV, BASIC</i> | <i>Table V, PRACTICE</i> | <i>Table VI, QUAL</i> | <i>Total</i> |
|---|---|---------------------------------------|------------------------|---------------------------|-----------------------|--------------|
| AB45 | CTG 9mm single round, DDI, M917A1 | 2 | 2 | 3 | | 3 |
| AC20 | CTG, 9mm F/M17 AND M18, military pack full metal jacket (FMJ) | | 20 | 30 | 30 | 80 |
| Additional Requirements When Authorized Simulation Systems are NOT Available: | | | | | | |
| <i>DODIC</i> | <i>Munition Type</i> | <i>Table VI, Qualification, CBRN</i> | | | | <i>Total</i> |
| AC20 | CTG, 9mm F/M17 and M18, military pack full metal jacket (FMJ) | 7 | | | | 7 |
| <i>DODIC</i> | <i>Munition Type</i> | <i>Table VI, Qualification, Night</i> | | | | <i>Total</i> |
| AC20 | CTG, 9mm F/M17 and M18, military pack full metal jacket (FMJ) | 5 | | | | 5 |
| <i>Model</i> | <i>LIN / NSN</i> | | <i>Model</i> | <i>LIN / NSN</i> | | |
| M9 | P98152 / 1005-01-118-2640 | | M18 | Z05424 / 1005-01-661-7323 | | |
| M17 | Z05425 / 1005-01-661-7317 | | | | | |
| <p>Note. Units are not resourced training ammunition for Table VI, Qualification, CBRN, or Table VI, Qualification, Night, when an authorized simulator system is provided as part of the basis of issue plan (BOIP). The military police school is the proponent for the M11 Pistol (LIN P47365), and is not included in this appendix.</p> | | | | | | |
| <p>Legend: CBRN – chemical, biological, radiological, nuclear, CTG – cartridge, DDI – dummy, drilled, inert, DODIC – Department of Defense identification code, GO – general officer, LIN – line item number, mm – millimeter, NSN – national stock number, QUAL – qualification course of fire</p> | | | | | | |

PISTOL, TABLE I, PRELIMINARY MARKSMANSHIP INSTRUCTION AND EVALUATION

D-6. The PMI&E event is a live-fire prerequisite that Soldiers must complete prior to executing for any pistol live-fire event. Pistol, Table I, PMI&E, consists of tasks that are critical to the safety of the firer, essential to the operation of the weapon assigned, or key to the effective employment of the weapon system. Leaders use Pistol, Table I to test the Soldier's ability to accomplish these critical tasks correctly, effectively, and efficiently. Leaders conduct all tasks in a garrison environment prior to the live-fire weapons training density.

TASK, CONDITIONS, AND STANDARD

D-7. Units are encouraged to conduct preparatory training prior to using Table I (for example, hip pocket training, STT) to maximize available resources. Units will develop a written test evaluating the functional aspects of the weapon, ammunition, and critical skills articulated in TC 3-23.35. Soldiers must successfully complete the tasks in Pistol, Table I, PMI&E, within the training window T-6 through T-week for both active Army and Reserves. (See table D-3.)

Note. Refer to TC 3-20.0 for more information on the training timelines for all live-fire prerequisites. Weapon specific and tactical employment information regarding pistol is in TC 3-23.35.

D-8. At a minimum, units provide instruction and evaluation on the standard PMI&E topics described in TC 3-23.35 to Soldiers assigned an M9-, M17- or M18-series weapon. Units may add topics to their Table I requirements, as necessary.

Table D-3. Pistol, Table I, Preliminary Marksmanship Instruction and Evaluation

| | |
|---|--|
| Task: | Demonstrate proficiency on the functional aspects of the weapon, ammunition, and critical skills necessary to correctly and safely employ the pistol. |
| Conditions: | In a garrison environment, given a pistol as assigned on the master authorization list for the unit. Provided the correct reference to conduct training: <ul style="list-style-type: none"> • TC 3-23.35, • TM 9-1005-317-10, or • TM 9-1005-470-10, or • TM 9-1005-325-10. |
| Standard: | The Soldier must successfully pass PMI&E between T-6 and T-week prior to firing any live ammunition by receiving all GOs on demonstrated performance and achieving a passing score of 80 percent or higher on a written test. |
| Legend: PMI&E – preliminary marksmanship instruction and evaluation, TC – training circular, TM – technical manual | |

D-9. Table D-4, on page D-4, shows the training event design template for Pistol, Table I, PMI&E. Units use the training event design templates to assist in the proper synchronization when developing their UTP.

Table D-4. Training event design template for Pistol, Table I

| <i>Pistol, Table I, PMI&E</i> | | | | | | |
|---|------------------|---------------------------|-------------------------|---------------------------------------|--------------------------|---------------------------------|
| EVENT NAME: | PMI&E | ENVIRONMENT: | | LIVE | 0.5 | |
| WEAPON: | M9, M17, M18 | CONDITIONS: | | HANDS ON | | |
| CATEGORY: | FOUNDATION | PRIMARY FACILITY: | | GARRISON | DAYS REQUIRED | |
| PUBLICATION: | TC 3-23.35 | ALTERNATE FACILITY: | | CLASS | | |
| REQUIRED: | YES | COMPONENT: | AC | RC | 60 SOLDIERS | |
| EXTERNAL EVAL: | OPTIONAL | FREQUENCY: | 2 | 1 | | |
| VALID FOR: | T+6 | ANNUAL DAYS TOTAL: | 1 | 0.5 | THROUGHPUT | |
| TABLE | | | | | | |
| | I | II | III | IV | V | VI |
| | PMI&E | PLFS | DRILLS | BASIC | PRACTICE | QUAL |
| | REQUIRED | | | | | 4.0 |
| WHEN EXECUTED: | T-6 through T-X | | | | | TNG DAYS TO QUAL |
| CONDEMNATION CRITERIA (CC) | RULE 1 | RULE 2 | RULE 3 | RULE 4 | RULE 5 | RULE 6 |
| | TIME | KEY LEADER TURNOVER | COMMANDER ASSESSMENT | SUBORDINATE ELEMENT PROFICIENCY | SPECIALTY PROFICIENCY | STAFF SECTION PROFICIENCY |
| <p>Remarks: Each Soldier assigned an individual weapon must successfully complete Table I, PMI&E, between T-6 and T-X, <i>prior to any live-fire event with the weapon.</i></p> | | | | | | |
| <p>Note: Table I <i>should</i> be completed prior to any other table to ensure the Soldier understands the proper functioning and immediate action for the weapon.</p> | | | | | | |
| <p>Legend: AC – active component (known as active duty), CLASS – classroom, EVAL – evaluation, PLFS – preliminary live-fire simulation, PMI&E – preliminary marksmanship instruction and evaluation, STT – sergeant’s time training, QUAL – qualification, RC – Reserve Component (known as Reserves), TC – training circular, T+6 – training week or month plus six, T-X – training event exercise, TNG DAYS TO QUAL – number of training days remaining on the critical path to weapon’s qualification</p> | | | | | | |

TRAINING PLAN

D-10. Table D-5 shows the Pistol Table I, PMI&E training plan's tasks. The Soldier demonstrates proficiency on those tasks to receive credit. Leaders and trainers must be proficient on these tasks prior to conducting training and testing.

Table D-5. Pistol Table I, Preliminary Marksmanship Instruction and Evaluation training plan

| Reference | Topic or Task |
|---|---|
| TC 3-23.35 | Ammunition identification |
| TC 3-23.35 | Rules of fire arms safety |
| TC 3-23.35 | Weapons safety status |
| TC 3-23.35 | Weapons control status |
| TC 3-23.35 | Cycle of function, pistol |
| TC 3-20.31-4 | Conduct of fire (fire commands) |
| TC 3-23.35 | Magazine change, pistol, emergency |
| TC 3-23.35 | Magazine change, pistol, tactical |
| TC 3-23.35 | Preliminary marksmanship instruction and evaluation (PMI&E), pistol |
| 071-COM-0001 | Maintain an M9 pistol |
| 071-COM-0002 | Perform functions check on an M9 pistol |
| 071-004-0007 | Maintain an M17 pistol |
| 071-004-000* | Perform functions check on an M17 pistol |
| Note: ALL Soldiers assigned a pistol will conduct PMI&E. Soldiers will conduct maintain and functions check tasks only for the weapon they are assigned. | |
| Legend: COM – common, TC – training circular | |

PISTOL TABLE II, PRELIMINARY LIVE-FIRE SIMULATIONS

D-11. Leaders use Table II, PLFS to evaluate the Soldier's ability to engage single and multiple stationary targets from multiple stationary supported firing positions, during day and limited visibility, and during CBRN conditions in a simulated combat environment. Soldiers are required to complete the simulations training plan prior to executing the Table II simulated qualification course of fire. Table II (see table D-6, on page D-6) is a live-fire prerequisite that Soldier's must complete prior to any event using live ammunition (Tables IV, V, and VI, for example).

TASK, CONDITIONS, AND STANDARD

D-12. Units must use the approved primary or alternate simulations to execute the tasks in Table II for training records between T 6 and T-week for the upcoming weapons training density. Units must maintain the training records for Soldiers for a period of 12 months. When conducting live-fire events, units must have the Soldier's Table II training records readily available on the range facility.

Table D-6. Pistol, Table II, Preliminary-Live-Fire Simulations

| | |
|--------------------|--|
| Task: | Demonstrate proficiency on the functional aspects of the weapon, ammunition, and critical skills necessary to correctly use the M9-, M17-, or M18-series pistol with associated equipment. |
| Conditions: | Given the following: <ul style="list-style-type: none">• Fully mission capable weapon and equipment as assigned on the master authorization list for the unit.• Full combat uniform, issued equipment, and protective mask (if assigned).• An authorized simulations device with standard training model and Pistol, Table II, Gate to Live Fire (GTLF) event. |
| Standard: | Demonstrate proficiency on select pistol tasks and successfully complete the GTLF event between T-6 and T-week prior to firing any live ammunition. |

D-13. Table D-7 shows the general training information for planning purposes for the Pistol, Table II. The training event design template provides key training information to develop the UTP for their Soldiers.

Table D-7. Training event design template for Pistol, Table II, Preliminary Live-Fire Simulations

| <i>Pistol, Table II, PLFS</i> | | | | | | |
|---|-----------------|------------------------|-------------------------|---------------------------------------|--------------------------|---------------------------------|
| EVENT NAME: | PLFS | ENVIRONMENT: | | VIRTUAL | 0.5 | |
| WEAPON: | M9, M17, M18 | CONDITIONS: | | TADSS | | |
| CATEGORY: | FOUNDATION | PRIMARY FACILITY: | | EST | DAYS REQUIRED | |
| PUBLICATION: | TC 3-23.35 | ALTERNATE FACILITY: | | TADSS | | |
| REQUIRED: | YES | COMPONENT: | AC | RC | 60 SOLDIERS | |
| EXTERNAL EVAL: | OPTIONAL | FREQUENCY: | 2 | 1 | | |
| VALID FOR: | T+6 | ANNUAL DAYS TOTAL: | 1 | 0.5 | THROUGHPUT | |
| TABLE | | | | | | |
| | I | II | III | IV | V | VI |
| | PMI&E | PLFS | DRILLS | BASIC | PRACTICE | QUAL |
| | | REQUIRED | | | | 3.5 |
| WHEN EXECUTED: | T-6 through T-X | | | | | TNG DAYS TO QUAL |
| CONDEMNATION CRITERIA (CC) | RULE 1 | RULE 2 | RULE 3 | RULE 4 | RULE 5 | RULE 6 |
| | TIME | KEY LEADER TURNOVER | COMMANDER ASSESSMENT | SUBORDINATE ELEMENT PROFICIENCY | SPECIALTY PROFICIENCY | STAFF SECTION PROFICIENCY |
| Remarks: Each Soldier assigned an individual weapon must successfully complete Table II, PLFS, between T-6 and T-X, prior to any live-fire event with the weapon. | | | | | | |
| Legend: AC – active component (known as active duty), EST – engagement skills trainer, EVAL- evaluation, PLFS – preliminary live-fire simulation, PMI&E – preliminary marksmanship instruction and evaluation, QUAL- qualification, RC – Reserve Component (known as Reserves), T+6 – training week or month plus six, T-X – training event exercise, TADSS – training aids, devices, simulators, and simulations, TC – training circular, TNG DAYS TO QUAL – number of training days remaining on the critical path to weapon's qualification | | | | | | |

SIMULATIONS

D-14. Each Soldier is authorized simulations usage for weapons training and sustainment based on their component. The authorized hours of training are cumulative annually so Soldiers can complete all required training prior to the execution of Table II training. Table D-8 shows the annual hours authorized per Soldier by component:

Table D-8. Annual simulations authorizations table

| <i>Simulation Time Authorizations (hours)</i> | |
|---|-----------------|
| <i>Active Army</i> | <i>Reserves</i> |
| 12.0 | 6.0 |

D-15. Table D-9 lists the primary and alternate simulations systems. Primary systems are the preferred method to deliver the appropriate training program to the Soldier. Alternate systems provide the minimum form, fit, and function capabilities to build the firer’s skill and experience on basic tasks. The unit determines how to use the simulations hours authorized per Soldier within the fiscal year.

Table D-9. Pistol, Table II, primary and alternate authorized systems

| System | Primary | Alternate | Remarks |
|---|----------------|------------------|---|
| Soldier and squad virtual trainer (S / SVT) | X | | |
| Engagement skills trainer | | X | Serves as a primary training device until S / SVT suite availability and accessibility are established Army-wide. |
| Dry-fire engagement drills | | X | Least preferred method. Commanders should review dry-fire drill tasks and effectiveness prior to authorizing use. |

Notes. For any other device or system not listed, the unit should contact the Maneuver Center of Excellence for possible system evaluation or if an approved training plan is available. Units are not authorized to develop training plans on unauthorized systems when authorized systems are available for training.

Individual weapons virtual simulation systems can effectively support no more than five firers per suite at a time. The standard simulations bay is composed of two suites, allowing for ten firers to train in a firing order. The unit develops a rotational plan to accommodate the total number of Soldiers training.

TRAINING PLAN

D-16. Soldiers train on their weapon according to the simulation system’s training plan. For simulation systems without an integrated training plan, operators must select the appropriate scenarios based on the system’s instructor utilization handbook (known as IUH).

D-17. The simulations pistol training plan culminates in the system’s gate to live fire (known as GTLF). Units may elect to train additional advanced tactical engagement scenarios but must conduct grouping practice, CBRN, night fire, and the gate to live fire exercises at a minimum, as listed in table D-10.

Table D-10. Pistol simulations training plan

| Task | Simulations Exercise Name | Required GTLF |
|--|---|----------------------|
| 1 | Auto zero (system maintenance function) | REQ |
| 2 | Grouping | REQ |
| 3 | Table V, Practice | REQ |
| 4 | Chemical, biological, radiological, and nuclear (CBRN) Fire | REQ |
| 5 | Night Fire | REQ |
| 6 | Table VI, Qualification | GTFLF |
| 7 | Practice grouping x2 per position (standing, kneeling, prone, and off-hand) | OPT |
| 8 | Magazine change multiple-target | OPT |
| 9 | Multiple directional moving target | OPT |
| 10 | Transition fire from rifle to pistol | OPT |
| Legend: GTLF – gate to live fire, OPT – optional , REQ – required | | |

PISTOL, TABLE III, DRILLS

D-18. Table III, Drills, is a series of physical actions (drills) that a Soldier completes with their assigned weapon and equipment in a repetitious manner to demonstrate proficiency in weapons handling and movement. Soldiers must successfully complete the drills in Table III prior to any live-fire event, including grouping procedures.

TASK, CONDITIONS, AND STANDARD

D-19. Typically, Soldiers conduct Table III training in a round-robin manner where the primary trainer is the team leader, squad leader, or assigned NCO. Table III's task, conditions, and standards are shown below in table D-11.

Table D-11. Pistol, Table III, Drills

| | |
|--------------------|--|
| Task: | Demonstrate proficiency on the functional aspects of the weapon, ammunition, and critical skills necessary to correctly use the M9-, M17-, or M18-series pistol with associated assigned equipment. |
| Conditions: | Given the following: <ul style="list-style-type: none"> Fully mission capable, weapon and equipment as assigned on the master authorization list for the unit. Checklist of required actions and time standards found in Training Circular (TC) 3-23.35 and associated individual task report described in this section. |
| Standard: | The Soldier successfully demonstrates proficiency by passing weapons handling, manipulation, and movement tasks listed in the training plan between T-6 and T-week prior to firing any live ammunition. |

D-20. Table D-12 shows the general training information for planning purposes for Pistol, Table III. The training event design template provides key training information to develop the unit training plan for their Soldiers.

Table D-12. Training event design template for Pistol, Table III, Drills

| <i>Pistol, Table III, Drills</i> | | | | | | |
|--|------------------------|---------------------------|-------------------------|---------------------------------------|--------------------------|---------------------------------|
| EVENT NAME: | DRILLS | ENVIRONMENT: | | LIVE | 0.5 | |
| WEAPON: | M9, M17, M18 | CONDITIONS: | | HANDS ON | | |
| CATEGORY: | FOUNDATION | PRIMARY FACILITY: | | GARRISON | DAYS REQUIRED | |
| PUBLICATION: | TC 3-23.35 | ALTERNATE FACILITY: | | TA | | |
| REQUIRED: | YES | COMPONENT: | AC | RC | 120 SOLDIERS | |
| EXTERNAL EVAL: | FIRST LINE LEADER | FREQUENCY: | 2 | 1 | | |
| VALID FOR: | T+6 | ANNUAL DAYS TOTAL: | 1 | 0.5 | THROUGHPUT | |
| | TABLE | | | | | |
| | I | II | III | IV | V | VI |
| | PMI&E | PLFS | DRILLS | BASIC | PRACTICE | QUAL |
| | | | REQUIRED | | | 3.0 |
| WHEN EXECUTED: | T-6 through T-X or T-X | | | | | TNG DAYS TO QUAL |
| CONDEMNATION CRITERIA (CC) | RULE 1 | RULE 2 | RULE 3 | RULE 4 | RULE 5 | RULE 6 |
| | TIME | KEY LEADER TURNOVER | COMMANDER ASSESSMENT | SUBORDINATE ELEMENT PROFICIENCY | SPECIALTY PROFICIENCY | STAFF SECTION PROFICIENCY |
| <p>Remarks: Each Soldier assigned an individual weapon must successfully complete Table III, between T-6 and T-X, prior to any live-fire event with the weapon. Table III should be used as concurrent training on Tables IV, V, and VI while Soldiers are awaiting training in a firing order or between day and night phases.</p> | | | | | | |
| <p>Legend: AC – active component (known as active duty), EVAL – evaluation, PLFS – preliminary live-fire simulation, PMI&E – preliminary marksmanship instruction and evaluation, QUAL – qualification, RC – Reserve Component (known as Reserves), STT – sergeant’s time training, T+6 – training week or month plus six, T-X – training event exercise, TA – training area, TC – training circular, TNG DAYS TO QUAL – number of training days remaining on the critical path to weapon’s qualification</p> | | | | | | |

TRAINING PLAN

D-21. The individual tasks for each of these drills is listed in the table D-13. The individual task reports for these drills are in a shared folder on AKO. The hyperlink to this folder is in the reference section at the back of this publication.

Table D-13. Pistol, Table III, Drills individual training plan

| <i>Task</i> | <i>Task Name</i> |
|---|--|
| 1 | Precombat checks |
| 2 | Load and conduct status check |
| 3 | Draw and holster from different firing positions |
| 4 | Fight down |
| 5 | Fight up |
| 6 | Go to prone |
| 7* | Transition from primary weapon to secondary weapon |
| 8 | Reload |
| 9 | Clear malfunction |
| 10 | Unload / show clear |
| <p>Note. Where the individual task reports are not available on the Army Training Network, the individual task reports for these drills are in a shared folder on Army Knowledge Online. The hyperlink to this folder is in the reference section at the back of this publication in the reference section.</p> <p>* This drill is only for Soldiers assigned multiple individual weapons or Soldiers assigned a pistol and a crew-served or special purpose weapon.</p> | |

D-22. Units may add to the drills listed in table D-13, but may not remove any drills from Table III. Units developing additional drills are encouraged to provide the details of the drill, evaluation process, and timing considerations to the proponent of this publication (listed in the preface) for possible inclusion into future revisions.

PISTOL, TABLE IV, BASIC (GROUPING)

D-23. Units conduct the training in Table IV, Basic (Grouping) with live ammunition on an approved range facility. All firers evaluate their ability to place shot groups consistently within a designated bullseye target at ranges between 5 to 25 meters using the information in Table IV. Units conduct the information in this table only after successful completion of the training in the live-fire prerequisite tables (Tables I, II, and III). During home station training, Soldiers must complete the training in Table IV prior to progressing to any other training event. Units conduct Table IV on a basic 10 m / 25 m firing range (zero) or other approved facility.

TASK, CONDITIONS, AND STANDARD

D-24. Firers conduct Table IV tasks from the standing position, with the weapon drawn, 10 meters from the targets outlined in figure D-1 on page D-15. Table IV training reinforces and builds upon skills learned in the previous training events. Table D-14, on page D-12, provides the task, conditions, and standards for Table IV.

Table D-14. Pistol, Table IV, Basic (Grouping)

| | |
|--------------------|--|
| Task: | Demonstrate grouping proficiency with the M9-, M17-, or M18-series pistol. |
| Conditions: | Given the following: <ul style="list-style-type: none"> Fully mission capable weapon, dummy, drilled, inert (DDI) rounds, holster, magazine pouches, and magazines. Authorized range facility, full-caliber ammunition, and approved targetry. |
| Standard: | Achieve 75-percent hits (three of four) inside the eight-inch outer ring of the A8 pistol marksmanship target, on 80-percent (four of five) of the shot groups fired. |

D-25. Table D-15 shows the training event design template for the Table IV, Basic (Grouping). Units conduct this event on an authorized live-fire facility, typically a basic 10 meter / 25 meter firing range (zero). See TC 25-8 for additional information on authorized range facilities.

Table D-15. Training event design template for Pistol, Table IV, Basic (Grouping)

| <i>Pistol, Table IV, Basic</i> | | | | | | |
|---|--------------|---------------------|----------------------|---------------------------------|-----------------------|---------------------------|
| EVENT NAME: | BASIC | | ENVIRONMENT: | LIVE | | 1.0 |
| WEAPON: | M9, M17, M18 | | CONDITIONS: | LIVE FIRE | | |
| CATEGORY: | FOUNDATION | | PRIMARY FACILITY: | Zero | | DAYS REQUIRED |
| PUBLICATION: | TC 3-23.35 | | ALTERNATE FACILITY: | CPQC | | |
| REQUIRED: | YES | | COMPONENT: | AC | RC | 120 SOLDIERS |
| EXTERNAL EVAL: | COACH | | FREQUENCY: | 2 | 1 | |
| VALID FOR: | T-X | | ANNUAL DAYS TOTAL: | 2 | 1 | THROUGHPUT |
| | TABLE | | | | | |
| | I | II | III | IV | V | VI |
| | PMI&E | PLFS | DRILLS | BASIC | PRACTICE | QUAL |
| | PRQ | PRQ | PRQ | REQUIRED | | 2.0 |
| WHEN EXECUTED: | | | | T-X | | TNG DAYS TO QUAL |
| CONDEMNATION CRITERIA (CC) | RULE 1 | RULE 2 | RULE 3 | RULE 4 | RULE 5 | RULE 6 |
| | TIME | KEY LEADER TURNOVER | COMMANDER ASSESSMENT | SUBORDINATE ELEMENT PROFICIENCY | SPECIALTY PROFICIENCY | STAFF SECTION PROFICIENCY |
| Remarks: Each Soldier assigned an individual weapon must successfully complete Table IV, Basic, as the event includes live fire zero of aiming devices. | | | | | | |
| Legend: AC – active component (known as active duty), CPQC – automated combat pistol qualification course, EVAL – evaluation, MRF – modified record fire range or similar, PLFS – preliminary live-fire simulation, PMI&E – preliminary marksmanship instruction and evaluation, PRQ – prerequisite, QUAL – qualification, RC – Reserve Component (known as Reserves), T-X – training event exercise, TC – training circular, TNG – training, TNG DAYS TO QUAL – number of training days remaining on the critical path to weapon's qualification, Zero – basic 10 meter / 25 meter range (zero) | | | | | | |

AMMUNITION

D-26. All Soldiers assigned a pistol on a unit MAL complete the tasks in Pistol, Table IV prior to advancing to Table V or Table VI. Soldiers conduct the training in Table IV to demonstrate their ability to place well-aimed shots consistently at or near the intended point of impact of a target. This skill is critical to the success of the Soldier during training and combat.

D-27. To effectively plan and forecast for sufficient training ammunition, the unit refers to the ammunition requirements listed in table D-16. Units identify the total number of firers and should plan for unscheduled firers and necessary retraining by increasing their forecasted training ammunition appropriately.

Table D-16. Table IV, Grouping ammunition authorizations

| <i>Training Event</i> | <i>DODIC</i> | <i>Nomenclature</i> | <i>Quantity</i> | <i>Remarks</i> |
|---|--------------|---|-----------------|--|
| Grouping | AC20 | CTG, 9mm F/M17 and M18, military pack full metal jacket (FMJ) | 20 | For grouping and executed during day only. |
| | AB45 | CTG 9mm single round, DDI, M917A1 | 2 | Used to reinforce clearing malfunctions and to identify recoil anticipation. |
| Legend: CTG – cartridge, DDI – dummy, drilled, inert, DODIC – Department of Defense identification code, mm – millimeter | | | | |

D-28. The ammunition NCO with a supporting detail (ammunition detail) loads two magazines with eight rounds, and one magazine with four rounds. One magazine includes two randomly placed DDI rounds. The DDI round may not be the first or the last round loaded in the magazine (may not be the bottom or top round). This is to ensure the DDI replicates a multifunction randomly during firing. Table D-17 shows the breakdown of magazines issued to each Soldier.

D-29. Table IV is an untimed event. Units issue Soldiers one four-round magazine each, one eight-round magazine each, and one 10-round magazine each, totaling 22 rounds of ammunition including DDI. Table D-17 shows the ammunition breakdown for Pistol, Table IV. The use of DDI ammunition reinforces proper weapons manipulation in the workspace and helps to identify Soldiers that anticipate recoil prior to firing. This allows a leader to recognize the issue and help the Soldier correct engagement technique errors at the earliest opportunity, prior to executing the tasks in Table V and Table VI. Firers place these magazines in their magazine pouches. Firers are not authorized staging or pre-positioning magazines for the conduct of Table IV tasks.

Table D-17. Pistol, Table IV, Ammunition breakdown per firer

| <i>Magazine</i> | <i>AC20 9mm Ball</i> | <i>AB45 9mm DDI</i> | <i>Total Rounds per Magazine</i> | <i>Remarks</i> |
|---|--------------------------|-------------------------|--------------------------------------|---|
| 1 | 4 each | | 4 rounds | DDI may not be the first or last round loaded into the magazine. They should be randomly placed to reinforce immediate action skills trained during Table I, II, and III. |
| 2 | 8 each | | 8 rounds | |
| 3 | 8 each | 2 each | 10 rounds | |
| Total | 20 rounds | 2 rounds | 22 rounds | |
| Legend: DDI – dummy, drilled, inert; mm – millimeter | | | | |

RANGE FACILITIES

D-30. Table D-18 shows the Army-standard range facilities specifically designed to support Pistol, Table IV, Basic (Grouping). Units reference their installation's range operations SOP or local training regulation to identify the weapon specific range facilities on the supporting installation. Units use their RFMSS system for all scheduling.

Table D-18. Pistol Table IV, Basic (Grouping) authorized range facilities and targetry

| <i>Range to Target</i> | <i>Targetry</i> | <i>Range Facility</i> | | |
|--|---|-----------------------|------------|-------------|
| | | <i>CPQC</i> | <i>QTR</i> | <i>Zero</i> |
| 10 meters | A8 target zero M4- / M16-series weapons 25m zero. Short range and pistol marksmanship target. NSN 6920-01-660-9191 | P | A | A |
| Legend: A – alternate facility, CPQC – combat pistol qualification course, m – meter, P – primary facility, QTR – qualification training range, NSN – national stock Number, Zero – basic 10 meter / 25 meter firing range (zero) | | | | |

TARGETRY

D-31. Table IV requires five targets per firer, placed on a target frame as shown on figure D-1, on page D-15. The targets are placed on a frame with backer board at the 10-meter line. This is a static target presentation and does not use the automated targets on the primary range facility (CPQC). During the preparation phase, leaders should be familiar with the targetry used, the target frames and their proper emplacement, and the firing sequence of the engagements. Figure D-1 shows the primary targets and their proper positioning on the primary range facility.

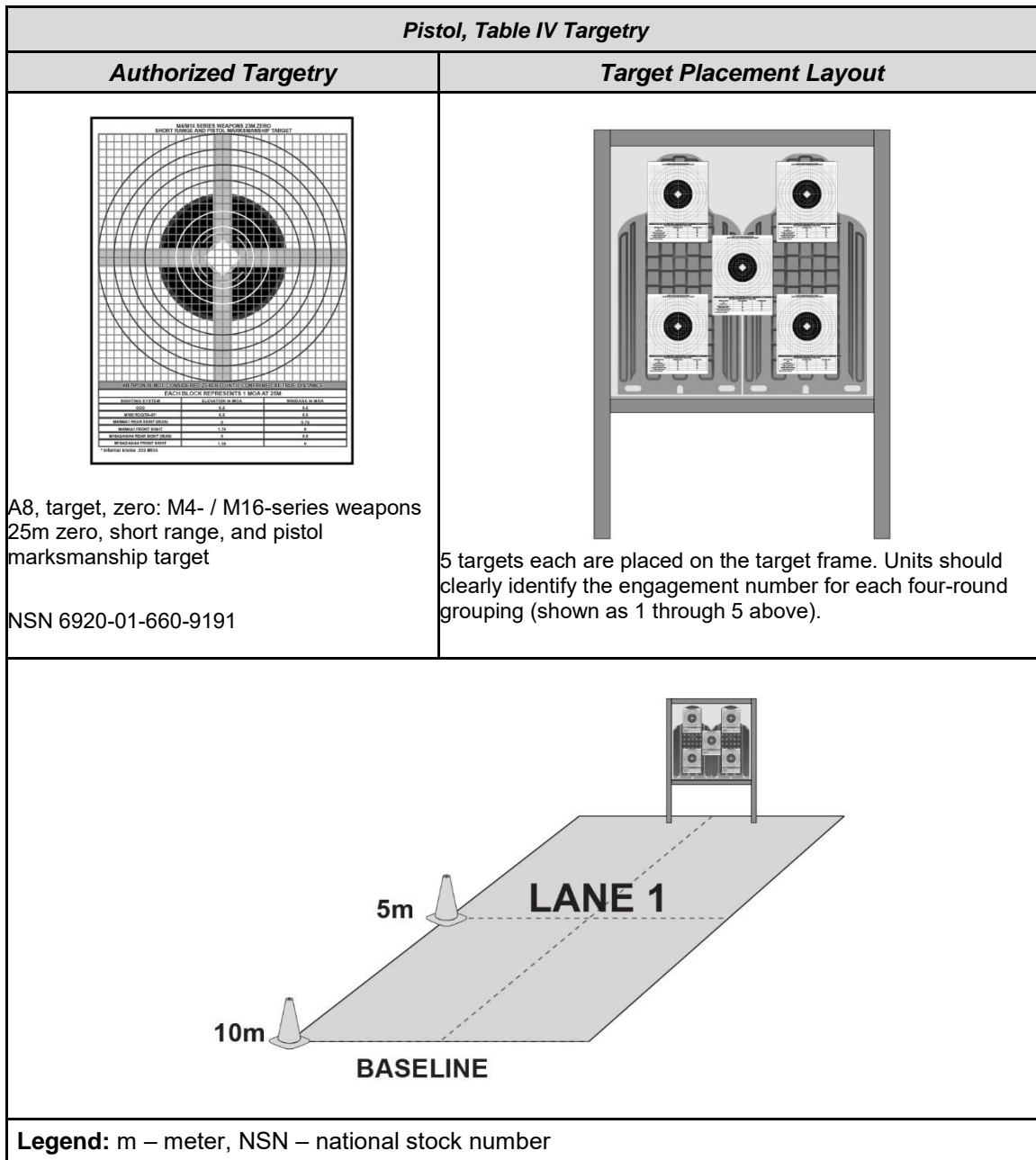

Figure D-1. Pistol, Table IV, target requirements example

CONDUCT OF THE RANGE

D-32. Soldiers learn the objectives of grouping and the importance of the functional elements of the shot process (see TC 3-23.35). Units conduct the sequences in Table IV using five separate engagements at targets 10 meters from the static firing point. Firers use one A8 target per group. Soldiers complete the engagements in the sequence shown in table D-19.

Table D-19. Pistol, Table IV, firing sequence example

| <i>Sequence / Magazines</i> | <i>AC20 9mm Ball</i> | <i>AB45 9mm DDI</i> | <i>Target</i> | <i>Target Types</i> |
|--|----------------------|---------------------|---------------|---------------------|
| 1 4-round | 4 each | | 1 | A8 |
| 2 8 round | 4 each | | 2 | A8 |
| | 4 each | | 3 | A8 |
| 3 10 round | 4 each | 2 each | 4 | A8 |
| | 4 each | | 5 | A8 |
| Note: The 10-round magazine includes eight each AC20 and two each AB45 randomly placed DDI. The two DDI may not be the first or last rounds loaded in the magazine. | | | | |
| Legend: DDI – dummy, drilled, insert; mm – millimeter | | | | |

D-33. Firers must group consistently by placing three of four rounds fired (75-percent) within the outer eight inch circle on the A8 target, on four of five (80-percent) of targets presented. There are no alibi firers.

D-34. Soldiers begin the Table IV tasks by moving into the firing position using administrative commands from the tower. Soldiers use administrative commands to control the flow of the range, movement of personnel, and other command and control purposes. Table D-20 provides an example of the administrative commands for moving a new firing order into position.

D-35. Soldiers enter the range and move to their firing points. Once at the firing point, firers assume a standing firing position with pistols holstered in a green weapons safety status. Soldiers fire the tasks in Table IV from the draw for each group, at each range, in the standing unsupported firing position.

Table D-20. Table IV, New Firing Order, conduct of the range example

| New Firing Order, Conduct of the Range | | | |
|--|---|-----------------------|---|
| <p>TARGET FRAME WITH 5 EACH A8 TARGETS AFFIXED.</p> <p>5m</p> <p>LANE 1</p> <p>10m</p> <p>BASELINE</p> | Task | Target | Target Type |
| | New Firing Order | N/A | N/A |
| | Rounds per Target | DODIC | Time (Seconds) |
| | N/A | AC20 | NO LIMIT |
| TOWER | | SOLDIER ACTION | |
| FIRERS ARE IN A GREEN STATUS | | | |
| CONDUCT OF THE RANGE | <p>FIRING ORDER (ONE) —</p> <p>FIRERS HOLSTER YOUR WEAPON AND SECURE YOUR AMMUNITION.</p> <p>ONCE COMPLETE, MOVE TO YOUR FIRING POINT.</p> <p>(ONCE SET)</p> <p>ADVANCE TO THE TEN METER FIRING LINE.</p> | | <p>Soldiers holster their weapon in a GREEN status, secure their three magazines, and move to their designated firing point along the baseline.</p> |
| FIRERS ARE IN A GREEN STATUS | | | |
| Once all firers are at their TEN-METER FIRING POINT, the tower continues. | | | |
| Legend: DODIC – Department of Defense identification code, m – meter, N/A – not applicable | | | |

D-36. As soon as the tower operator confirms all firers are at the appropriate firing point, the tower operator proceeds to the first engagement. Table D-21 lists the tower operator commands for the first engagement.

Table D-21. Table IV, Engagement 1, first shot group, conduct of fire example

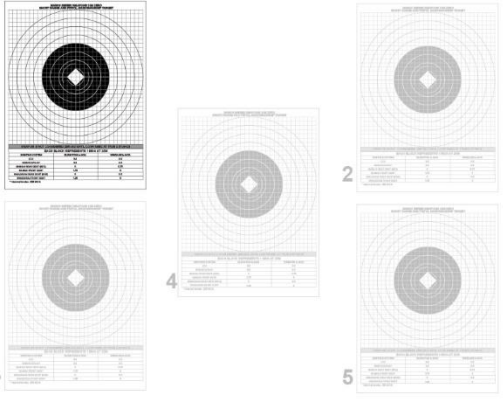
| <i>Table IV, Engagement 1 – First Shot Group</i> | | | |
|---|--|---|-----------------------|
|  | Engagement | Target | Target Type |
| | 1 | A8 | Zero / Bull Ring |
| | Rounds per Engagement | DODIC | Time (Seconds) |
| | 4 | AC20 | NO LIMIT |
| TOWER | | SOLDIER ACTION | |
| WEAPONS SAFETY STATUS RED | MAKE READY | Soldier draws pistol and loads one four-round magazine, ensuring weapon is on SAFE, and stands at the READY. | |
| ALERT | FIRERS | | |
| TARGET DESCRIPTION | PANEL ONE | Soldier acquires the designated A8 target. | |
| DIRECTION | FRONT | | |
| RANGE | CLOSE QUARTERS | Soldier aims center of visible mass of the target. | |
| CONTROL | FOUR ROUNDS SLOW FIRE WEAPONS FREE WEAPONS FREE | | |
| EXECUTION | ENGAGE UPON POSITIVE IDENTIFICATION | Soldier begins slow firing one four-round shot group, ensuring the same point of aim for each round. If a malfunction occurs, firer clears the malfunction and continues until the task is complete. | |
| TOWER AWAITS ALL FIRERS TO COMPLETE THE FOUR-ROUND GROUP | | | |
| TERMINATION | CEASE FIRE CEASE FIRE | The firer's slide should be locked to the rear. Tower must assume all weapons are RED. | |
| WEAPONS SAFETY STATUS RED | RELOAD AND HOLSTER | Soldier RELOADS with the eight-round magazine, confirms SAFE, holsters the weapon and awaits for further instruction. | |
| Once all firers are complete, the tower directs: MOVE TO THE TARGET AND REVIEW YOUR SHOT GROUP. ONCE COMPLETE, RETURN TO THE FIRING POINT. | | | |
| Legend: DODIC – Department of Defense identification code | | | |

D-37. Once all firers have completed the first task the TOWER prepares for engagement 2, shown in table D-22. The tower's initial command initiates the firer to RELOAD and MAKE READY with their weapon already in a red status.

Table D-22. Table IV, Engagement 2, second shot group, conduct of fire example

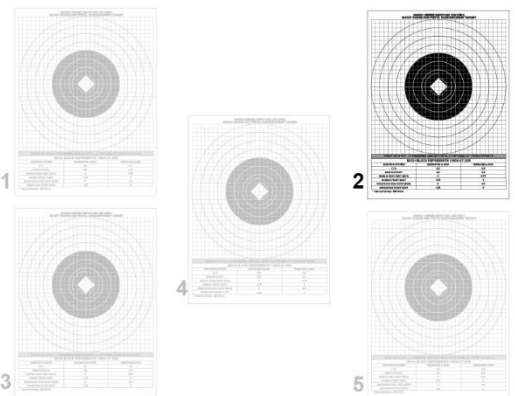
| <i>Table IV, Engagement 2 – Second Shot Group</i> | | | |
|---|--|--|-----------------------|
|  | Engagement | Target | Target Type |
| | 2 | A8 | Zero / Bull Ring |
| | Rounds per Engagement | DODIC | Time (Seconds) |
| | 4 | AC20 | NO LIMIT |
| TOWER | | SOLDIER ACTION | |
| WEAPONS SAFETY STATUS RED | MAKE READY | Soldier draws pistol ensuring weapon is on SAFE and stands at the READY. | |
| ALERT | FIRERS | | |
| TARGET DESCRIPTION | PANEL TWO | Soldier acquires the designated A8 target. | |
| DIRECTION | FRONT | | |
| RANGE | CLOSE QUARTERS | Soldier aims center of visible mass of the target. | |
| CONTROL | FOUR ROUNDS SLOW FIRE WEAPONS FREE WEAPONS FREE | | |
| EXECUTION | ENGAGE UPON POSITIVE IDENTIFICATION | The Soldier begins slow firing one four-round shot group, ensuring the same point of aim for each round. If a malfunction occurs, firer clears the malfunction and continues until the task is complete. | |
| TOWER AWAITS ALL FIRERS TO COMPLETE THE FOUR-ROUND GROUP | | | |
| TERMINATION | CEASE FIRE CEASE FIRE | Soldier stops firing and places weapon on SAFE. | |
| WEAPONS SAFETY STATUS RED | ONCE COMPLETE HOLSTER | Soldier confirms SAFE, holsters the weapon and awaits for further instruction. | |
| Once all firers are complete, the tower directs: MOVE TO THE TARGET AND REVIEW YOUR SHOT GROUP. ONCE COMPLETE, RETURN TO THE FIRING POINT. | | | |
| Legend: DODIC – Department of Defense identification code | | | |

D-38. Once all firers have completed the second task, the tower operator prepares for engagement 3, shown in table D-23. The tower operator places the firers in a red status to begin the engagement.

Table D-23. Table IV, Engagement 3, third shot group, conduct of fire example

| <i>Table IV, Engagement 3 – Third Shot Group</i> | | | |
|---|--|---|-----------------------|
| | Engagement | Target | Target Type |
| | 3 | A8 | Zero / Bull Ring |
| | Rounds per Target | DODIC | Time (Seconds) |
| | 4 | AC20 | NO LIMIT |
| TOWER | | SOLDIER ACTION | |
| WEAPONS SAFETY STATUS RED | MAKE READY | Soldier draws pistol, verifies weapon is on SAFE, and stands at the READY. | |
| ALERT | FIRERS | | |
| TARGET DESCRIPTION | PANEL THREE | Soldier acquires the designated A8 target. | |
| DIRECTION | FRONT | | |
| RANGE | CLOSE QUARTERS | | |
| CONTROL | FOUR ROUNDS SLOW FIRE WEAPONS FREE WEAPONS FREE | | |
| EXECUTION | ENGAGE UPON POSITIVE IDENTIFICATION | Soldier begins slow firing one four-round shot group, ensuring the same point of aim for each round. If a malfunction occurs, firer clears the malfunction and continues until the task is complete. | |
| TOWER AWAITS ALL FIRERS TO COMPLETE THE FOUR-ROUND GROUP. | | | |
| TERMINATION | CEASE FIRE CEASE FIRE | The firer's slide should be locked to the rear. Tower must assume all weapons are RED. | |
| WEAPONS SAFETY STATUS RED | RELOAD AND HOLSTER | Soldier RELOADS with the 10-round magazine, confirms SAFE, holsters the weapon and awaits for further instruction. | |
| Once all firers are complete, the tower directs: MOVE TO THE TARGET AND REVIEW YOUR SHOT GROUP. ONCE COMPLETE, RETURN TO THE FIRING POINT. | | | |
| Legend: DODIC – Department of Defense identification code | | | |

D-39. Once all firers have completed the third engagement, the tower operator prepares for engagement 4, shown in table D-24. The tower operator begins the engagement by directing the firers to RELOAD and MAKE READY.

Table D-24. Table IV, Engagement 4, fourth shot group, conduct of fire example

| <i>Table IV, Engagement 4 – Fourth Shot Group</i> | | | |
|---|--|--|-----------------------|
| | Engagement | Target | Target Type |
| | 4 | A8 | Zero / Bull Ring |
| | Rounds per Target | DODIC | Time (Seconds) |
| | 4 | AC20 | NO LIMIT |
| TOWER | | SOLDIER ACTION | |
| WEAPONS SAFETY STATUS RED | MAKE READY | Soldier draws pistol, verifies SAFE, and stands at the READY. | |
| ALERT | FIRERS | | |
| TARGET DESCRIPTION | PANEL FOUR | Soldier acquires the designated A8 target. | |
| DIRECTION | FRONT | | |
| RANGE | CLOSE QUARTERS | Soldier aims center of visible mass of the target. | |
| CONTROL | FOUR ROUNDS SLOW FIRE WEAPONS FREE WEAPONS FREE | | |
| EXECUTION | ENGAGE UPON POSITIVE IDENTIFICATION | Soldier begins slow firing one four-round shot group, ensuring the same point of aim for each round. If a malfunction occurs, firer clears the malfunction and continues until the task is complete. | |
| TOWER AWAITS ALL FIRERS TO COMPLETE THE FIRST FOUR-ROUND GROUP | | | |
| TERMINATION | CEASE FIRE CEASE FIRE | Soldier places weapon on SAFE. | |
| WEAPONS SAFETY STATUS RED | ONCE COMPLETE HOLSTER | Soldier verifies SAFE, holsters the weapon and awaits further commands. | |
| Once all firers are complete, the tower directs: MOVE TO THE TARGET AND REVIEW YOUR SHOT GROUP. ONCE COMPLETE, RETURN TO THE FIRING POINT. | | | |
| Legend: DODIC – Department of Defense identification code | | | |

D-40. Once all firers have completed the fourth task the tower operator prepares for engagement 5, shown in table D-25. The tower operator begins the engagement by directing firers to MAKE READY.

Table D-25. Table IV, Engagement 5, fifth shot group, conduct of fire example

| <i>Table IV, Engagement 5 – Fifth Shot Group</i> | | | |
|--|--|--|-----------------------|
| | Engagement | Target | Target Type |
| | 5 | A8 | Zero / Bull Ring |
| | Rounds per Target | DODIC | Time (Seconds) |
| | 4 | AC20 | NO LIMIT |
| TOWER | | SOLDIER ACTION | |
| WEAPONS SAFETY STATUS RED | MAKE READY | Soldier draws pistol, ensures the weapon is on SAFE, and stands at the READY. | |
| ALERT | FIRERS | | |
| TARGET DESCRIPTION | PANEL FIVE | Soldier acquires the designated A8 target. | |
| DIRECTION | FRONT | | |
| RANGE | CLOSE QUARTERS | Soldier aims center of visible mass of the target. | |
| CONTROL | FOUR ROUNDS SLOW FIRE WEAPONS FREE WEAPONS FREE | | |
| EXECUTION | ENGAGE UPON POSITIVE IDENTIFICATION | Soldier begins slow firing one four-round shot group, ensuring the same point of aim for each round. If a malfunction occurs, firer clears the malfunction and continues until the task is complete. | |
| TOWER AWAITS ALL FIRERS TO COMPLETE THE FIRST FOUR-ROUND GROUP | | | |
| TERMINATION | CEASE FIRE CEASE FIRE | The firer's slide should be locked to the rear. Tower must assume all weapons are RED. | |
| WEAPONS SAFETY STATUS GREEN | GO GREEN GO GREEN ONCE COMPLETE HOLSTER | Soldier clears and holsters the weapon and awaits for the command to move forward of the firing line to collect their target. | |
| Once all firers are complete, the tower directs: MOVE TO THE TARGET AND REVIEW YOUR SHOT GROUP. REPLACE ALL TARGETS, ONCE COMPLETE, RETURN TO THE FIRING POINT. | | | |
| Legend: DODIC – Department of Defense identification code | | | |

D-41. Upon the Soldiers completion of grouping and recovering their targets, firers must collect their brass, ammunition, magazines, and DDI, after which the lane safety personnel clears them. Once complete, the lane safety personnel communicate the WSS to the tower operator and the tower operator issues an administrative command to move the completed Soldiers off the range. Table D-26 is an example of this command.

Table D-26. Table IV, Completed Firing Order, conduct of the range example

| Completed Firing Order, Conduct of the Range | | | |
|---|---|--|-----------------------|
| FIRING ORDER COMPLETE | Task | Target | Target Type |
| | Completed Firing Order | N/A | N/A |
| | Rounds per Target | DODIC | Time (Seconds) |
| | N/A | N/A | NO LIMIT |
| TOWER | | SOLDIER ACTION | |
| FIRERS ARE IN A GREEN STATUS | | | |
| CONDUCT OF THE RANGE | SECURE YOUR DUNNAGE, MAGAZINES, AMMUNITION, AND DDI ONCE SET, MOVE TO THE BASELINE ENTRY CONTROL POINT | Firers secure weapon and ammunition dunnage and move to the designated location. | |
| ONCE ALL FIRERS HAVE EXITED THROUGH THE BASELINE ENTRY CONTROL POINT, THE TOWER DIRECTS THE MOVEMENT OF THE NEXT FIRING ORDER. | | | |
| Legend: DDI – dummy, drilled, inert; DODIC – Department of Defense identification code, N/A – not applicable | | | |

D-42. Leaders review the shot groups for their Soldiers. Prior to departing the target area, the Soldier or coach removes all targets and affixes five new A8 targets for the next firing order.

D-43. The tower must provide time for the completed firing order to secure any DDI from the firing point and ensure it is returned to the ammunition issue point for reuse. As soon as the lane safety clears the completed firing order, the tower operator moves a new firing order into position and the process repeats itself until all firers have successfully grouped.

PISTOL, TABLE V, PRACTICE

D-44. Table V, Practice, is a practice table used in preparation for the qualification course. Leaders use Table V to challenge firers with single and multiple stationary targets from the standing and kneeling firing positions and while moving within the effective range of the weapon. Leaders use Table V to train the firer to engage single and multiple targets placed in a tactical array using iron sights and to apply the functional elements of the shot process. In a timed scenario, the firer experiences and learns target prioritization and weapons manipulation. Leaders conduct the tasks in Table V on a CPQC. Firers fire tasks in the standing position or while moving.

TASK, CONDITIONS, AND STANDARD

D-45. Table D-27 outlines the tasks, conditions, and standards for the conduct of Table V tasks. The firer conducting the event should know the tasks, conditions, and standards for the conduct of Table V, and explain them during the conduct of the range briefing.

Table D-27. Pistol, Table V, Practice

| | |
|--------------------|---|
| Task: | Engage and defeat single and multiple threats at varying ranges while stationary and moving during day and limited visibility conditions using ball ammunition. |
| Conditions: | Given the following: <ul style="list-style-type: none"> • Fully mission capable weapon as assigned on the master authorization list for the unit. • Full combat uniform, issued equipment, and protective mask (if assigned). • Authorized range facility. • Full-scale, approved targetry in standard scenario engagement sequences. • Authorized ammunition. |
| Standard: | Demonstrate engagement proficiency by hitting 70 percent (21 of 30) of all presented targets in the time allotted. |

D-46. Table D-28 shows the training event design template for Pistol, Table V, Practice. Firers conduct this event on an authorized live-fire facility, typically a CPQC. See TC 25-8 for additional information on authorized range facilities.

Table D-28. Training event design template for Pistol, Table V, Practice

| <i>Pistol, Table V, Practice</i> | | | | | | |
|---|--------------|---------------------------|-------------------------|---------------------------------------|--------------------------|---------------------------------|
| EVENT NAME: | PRACTICE | | ENVIRONMENT: | LIVE | | 1.0 |
| WEAPON: | M9, M17, M18 | | CONDITIONS: | LIVE FIRE | | |
| CATEGORY: | FOUNDATION | | PRIMARY FACILITY: | CPQC | | DAYS REQUIRED |
| PUBLICATION: | TC 3-23.35 | | ALTERNATE FACILITY: | QTR | | |
| REQUIRED: | YES | | COMPONENT: | AC | RC | 120 SOLDIERS |
| EXTERNAL EVAL: | COACH | | FREQUENCY: | 2 | 1 | |
| VALID FOR: | T-X | | ANNUAL DAYS TOTAL: | 2 | 1 | THROUGHPUT |
| | TABLE | | | | | |
| | I | II | III | IV | V | VI |
| | PMI&E | PLFS | DRILLS | BASIC | PRACTICE | QUAL |
| | PRQ | PRQ | PRQ | | | 1.0 |
| WHEN EXECUTED: | | | | | T-X | TNG DAYS TO QUAL |
| CONDEMNATION CRITERIA (CC) | RULE 1 | RULE 2 | RULE 3 | RULE 4 | RULE 5 | RULE 6 |
| | TIME | KEY LEADER TURNOVER | COMMANDER ASSESSMENT | SUBORDINATE ELEMENT PROFICIENCY | SPECIALTY PROFICIENCY | STAFF SECTION PROFICIENCY |
| Remarks: Each Soldier assigned an individual weapon <i>should</i> successfully complete Table V, Practice, to gain experience with and confidence in their weapon, aiming devices, and skill. | | | | | | |
| Legend: AC – active component (known as active duty), ARF – automated record fire range or similar, CPQC – automated combat pistol qualification course, EVAL – evaluation, PLFS – preliminary live-fire simulation, PMI&E – preliminary marksmanship instruction and evaluation, PRQ – prerequisite, QTR – qualification training range, QUAL – qualification, RC – Reserve Component (known as Reserves), T-X – training event exercise, TC – training circular, TNG DAYS TO QUAL – number of training days remaining on the critical path to weapon’s qualification | | | | | | |

AMMUNITION

D-47. All Soldiers assigned a pistol on a unit MAL complete the events in Pistol, Table V prior to advancing to Table VI. Firers conduct the Table V events to demonstrate their proficiency to lethally employ a pistol during a close quarter’s fight prior to conducting the qualification course of fire, Table VI.

D-48. To effectively plan and forecast for sufficient training ammunition, the unit uses the ammunition requirements listed in table D-29, on page D-26. Units need to identify the total number of firers and should plan for unscheduled firers and necessary retraining by increasing their forecasted training, as appropriate.

Table D-29. Table V, Practice ammunition requirements

| <i>Training Event</i> | <i>DODIC</i> | <i>Nomenclature</i> | <i>Quantity</i> | <i>Remarks</i> |
|---|--------------|---|-----------------|--|
| Practice | AC20 | CTG, 9mm F/M17 and M18, military pack full metal jacket (FMJ) | 30 | One round per target is required. |
| | AB45 | CTG 9mm single round, DDI, M917A1 | 3 | Used to reinforce clearing malfunctions and to identify recoil anticipation. |
| Legend: CTG – cartridge, DDI – dummy, drilled, inert; DODIC – Department of Defense identification code, mm – millimeter | | | | |

D-49. The Table V event is an automated timed event that consists of three tasks. Every leader issues the firers ammunition as shown in table D-30 to conduct the event in Pistol, Table V, Practice. Firers place these magazines in their magazine pouches. Staging or pre-positioning magazines is not authorized for the conduct of Table V training.

Table D-30. Pistol, Table V, Practice ammunition breakdown

| <i>Phase</i> | <i>Sequence / Magazine</i> | <i>AC20 9mm Ball</i> | <i>AB45 9mm DDI</i> | <i>Magazine Total Rounds</i> |
|---|----------------------------|----------------------|---------------------|------------------------------|
| Standing | 1 | 10 each | 1 each | 12 rounds |
| Kneeling | 2 | 10 each | 1 each | 12 rounds |
| Moving | 3 | 10 each | 1 each | 12 rounds |
| Note: The 12-round magazines includes 10 each AC20 and 2 each AB45 randomly placed DDI. The DDI rounds may not be the first or last rounds loaded into the magazine. | | | | |
| Legend: DDI – dummy, drilled, inert; mm – millimeter | | | | |

RANGE FACILITIES

D-50. Table D-31 shows the Army-standard range facilities designed to support Table V, Practice training. Units must refer to their installation’s range operations SOPs or local training regulation to identify the weapon specific range facilities. Units use their RFMSS system for all scheduling.

Table D-31. Pistol, Table V, Practice authorized range facilities

| Table V | Target | Range Facility | |
|---|---|----------------|-----|
| | | CPQC | QTR |
| Practice | E-type, E1, target, silhouette: plastic, polyethylene, kneeling (NSN: 6920-00-071-4780) | P | A |
| Legend: A – alternate, CPQC – combat pistol qualification course, NSN – national stock number, P – primary, QTR – qualification training range | | | |

TARGETRY

D-51. Table V training requires silhouette targetry, either E-type or D-type targets on the range. The leader must confirm the type and capability of the range’s targetry, lifting mechanisms, and simulators, and identify any unit requirements. During the preparation phase, leaders should be familiar with the targetry used and the sequence of the firing events. Figure D-2 shows the authorized targetry used during Table V training.



| <i>E-1</i> Target, silhouette: plastic, polyethylene, kneeling NSN 6920-00-071-4780 | <i>D-1</i> Target, 3-dimensional: plastic, mannequin, kneeling NSN 6920-01-164-9625 |
|---|--|
|  |  |
| Use of E-1 or D-1 kneeling targets is at the discretion of the installation. Both represent dismounted, kneeling Infantry targets on small arms and maneuver facilities. Use of F-type or G-2 prone targets is not authorized. | |
| Legend: NSN – national stock number | |

Figure D-2. Table V, authorized target types

SCENARIO ENGAGEMENTS

D-52. Targets are presented to the firer in single and double target arrays. Targets are presented such that 90 percent of the target is clearly visible to the firer from the expected or planned firing position. Single targets are exposed for three seconds and double target presentations are exposed for five seconds. After each phase of 10 target presentations, there is a 10-second transition delay providing the firer time to conduct an emergency reload and assume the next specified position. The firer is told the firing position sequence during the conduct of the range brief, and is given RELOAD and FIGHT DOWN commands from the tower operator between engagements. Table D-32 through D-34, pages D-28 through D-30, show the scenario engagement sequence for Table V training.

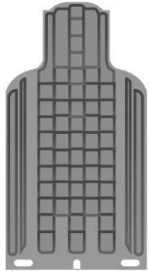
Table D-32. Pistol Table V, Practice target engagement sequence

| <i>Table V, Practice, Engagements 1 through 9, Standing , Baseline</i> | | | |
|---|--------------------|-----------------------|-----------------------|
| <i>Engagement</i> | <i>Target Type</i> | <i>Range (meters)</i> | <i>TIME (seconds)</i> |
| 1 | E-type | 7 LEFT | 3 |
| 2 | E-type | 12.5 | 3 |
| 3 | E-type | 23 | 3 |
| 4 | E-type | 31 | 3 |
| 5 | E-type | 10 | 3 |
| 6 | E-type | 16.5 | 3 |
| 7 | E-type | 27 | 3 |
| 8 | E-type | 7 RIGHT | 3 |
| 9 | E-type | 10 | 5 |
| | E-type | 12.5 | |
| An 8-second delay time is incorporated at the end of Engagement 9 to facilitate magazine and firing position changes. | | | |
| Note: There is a two second delay between all engagements in this phase. | | | |

Table D-33. Pistol, Table V, Practice engagements 10 through 17 sequence

| <i>Table V, Practice, Engagements 10 through 17, Kneeling, Baseline</i> | | | |
|---|--------------------|-----------------------|--------------------------------|
| <i>Engagement</i> | <i>Target Type</i> | <i>Range (meters)</i> | <i>Exposure Time (seconds)</i> |
| 10 | E-type | 23 | 3 |
| 11 | E-type | 31 | 3 |
| 12 | E-type | 16.5 | 3 |
| 13 | E-type | 27 | 3 |
| 14 | E-type | 7 RIGHT | 5 |
| | E-type | 10 | |
| 15 | E-type | 12.5 | 3 |
| 16 | E-type | 23 | 3 |
| 17 | E-type | 16.5 | 5 |
| | E-type | 12.5 | |
| An 8-second delay is incorporated into the scenario after Engagement 17 to facilitate magazine and firing position changes. | | | |
| Note: There is a two second delay between all engagements in this phase. | | | |

Table D-34. Pistol, Table V, Practice engagements 18 through 23 sequence

| <i>Table V, Practice, Engagements 18 through 23, Moving, Baselines</i> | | | |
|---|--------------------|-----------------------|--------------------------------|
| <i>Engagement</i> | <i>Target Type</i> | <i>Range (meters)</i> | <i>Exposure Time (seconds)</i> |
| 18 | E-type | 7 LEFT | 5 |
| | E-type | 7 RIGHT | |
| 19 | E-type | 10 | 5 |
| | E-type | 12.5 | |
| 20 | E-type | 16.5 | 5 |
| | E-type | 23 | |
| 21 | E-type | 23 | 5 |
| | E-type | 27 | |
| 22 | E-type | 27 | 3 |
| 23 | E-type | 31 | 3 |
| Note: There is a 2-second delay between all engagements in this phase. | | | |

CONDUCT OF THE RANGE

D-53. Leaders instruct Soldiers on the objectives of Table V tasks and the importance of the functional elements of the shot process. Table V contains 23 firing tasks with an administrative pause programmed at the end of each phase to facilitate emergency reloading and changing positions.

D-54. Soldiers enter the range and move to their firing points. Once at the firing point, firers assume a standing firing position with pistols holstered in a green status. Soldiers fire Table V tasks from the ready throughout the duration of the course of fire, where—

- Tasks 1 through 9 are fired from the standing unsupported position.
- Tasks 10 through 17 are fired from the kneeling position.
- Tasks 18 through 23 are fired as the Soldier moves down the 1-meter wide, 10-meter long walk path.

D-55. Firers must hit a minimum of 21 of the 30 targets presented (70 percent) to successfully pass this event. Soldiers are not required to complete this table before conducting Table VI training.

D-56. Soldiers begin Table V training by moving into the firing position with the use of administrative commands from the tower operator. Tower operator’s use administrative commands to control the flow of the range, movement of personnel, and other command and control purposes. Table D-35 provides an example of the administrative commands for moving a new firing order into position.

Table D-35. Table V, New Firing Order, conduct of the range example

| <i>New Firing Order, Conduct of the Range</i> | | | |
|--|---|---------------|-----------------------|
| | Task | Target | Target Type |
| PRACTICE | New Firing Order | N/A | N/A |
| | Rounds per Target | DODIC | Time (Seconds) |
| | N/A | AC20 | NO LIMIT |
| TOWER | SOLDIER ACTION | | |
| CONDUCT OF THE RANGE | <p>HOLSTER YOUR WEAPON</p> <p>SECURE YOUR AMMUNITION AND MOVE TO YOUR FIRING POINT</p> <p>Soldiers holster their weapon in a GREEN status, secure ammunition in three magazines, and move to the designated firing point.</p> | | |
| Once all firers are complete, conduct of the range continues. | | | |
| Legend: DODIC – Department of Defense identification code, N/A – not applicable | | | |

D-57. As soon as the tower confirms all firers are at the appropriate firing point the tower operator proceeds to the next task. Tables D-36 through D-38, on pages D-32 through D-34, provide the tower operator with a generic conduct of fire process for the engagement.

Table D-36. Table V, engagement 1 through 9, conduct of fire example

| <i>Engagement 1 through 9 – Day Fire, Standing, 1 Magazine (10-rounds)</i> | | | |
|--|--|--|-----------------------|
| | Engagement | Target | Target Type |
| | 1 through 9 | E-1 | Point |
| | Rounds | DODIC | Time (Seconds) |
| | 1 magazine 12 rounds | AC20 (10) AB45 (2) | 29 |
| TOWER | | SOLDIER ACTION | |
| FIRERS | | | |
| WEAPONS SAFETY STATUS RED | LOAD ONE TWELVE-ROUND MAGAZINE | Soldier draws pistol and loads one 12-round magazine ensuring weapon is on SAFE, and stands at the READY. | |
| MAKE READY | | | |
| ALERT | CONTACT | | |
| TARGET DESCRIPTION | MULTIPLE ENEMY TROOPS | | |
| DIRECTION | FRONT | | |
| RANGE | CLOSE QUARTERS | | |
| METHOD | NEAR TO FAR | | |
| CONTROL | WEAPONS FREE WEAPONS FREE | Soldier moves the weapon from SAFE to FIRE, and begins the target acquisition process. | |
| EXECUTION | ENGAGE UPON POSITIVE IDENTIFICATION | Soldier acquires, prioritizes, and engages targets with one round per target. If a malfunction occurs, firer clears the malfunction and continues until the task is complete. | |
| TOWER AWAITS COMPLETION OF ENGAGEMENT 9 THEN PROCEEDS IMMEDIATELY | | | |
| WEAPONS SAFETY STATUS REMAINS RED | | | |
| <p>Note: There is a 2-second delay between all engagements. There is a 10-second delay at the end of the phase to support changing the magazine and changing the firing position.</p> | | | |
| <p>Legend: DODIC – Department of Defense identification code</p> | | | |

Table D-37. Table V, engagement 10 through 17, conduct of fire example

| Engagement 10 through 17 – Day Fire, Kneeling, 1 Magazine (10-rounds) | | | |
|--|---|---|----------------|
| | Engagement | Target | Target Type |
| | 10 through 17 | E-1 | Point |
| | Rounds | DODIC | Time (Seconds) |
| 1 magazine, 12 rounds | AC20 (10) AB45 (2) | 29 | |
| TOWER | | SOLDIER ACTION | |
| WEAPONS SAFETY STATUS RED | <i>Although the firer's slide should be locked to the rear, the tower must treat all firers in a RED status</i> | Soldier remains at the READY and may RELOAD or await instructions. | |
| CONTROL | RELOAD FIGHT DOWN | The Soldier conducts an emergency RELOAD and assumes the kneeling position and prepares to engage. | |
| TOWER AWAITS THE END OF THE 10 SECOND TRANSITION THEN PROCEEDS | | | |
| EXECUTION | ENGAGE UPON POSITIVE IDENTIFICATION | Soldier acquires, prioritizes, and engages targets with one round per target. If a malfunction occurs, firer clears the malfunction and continues until the task is complete. | |
| TOWER AWAITS COMPLETION OF ENGAGEMENT 17 THEN PROCEEDS IMMEDIATELY | | | |
| WEAPONS SAFETY STATUS REMAINS RED | | | |
| <p>Note: There is a 2-second delay between all engagements. There is a 10-second delay at the end of the phase to support changing the magazine and changing the firing position.</p> <p>Legend: DODIC – Department of Defense identification code</p> | | | |

Table D-38. Table V, engagement 18 through 23, conduct of fire example

| <i>Engagement 18 through 23 – Day Fire, Moving, 1 Magazine (10-rounds)</i> | | | |
|--|--|--|---|
| | Engagement | Target | Target Type |
| | 18 through 23 | E-1 | Point |
| | Rounds | DODIC | Time (Seconds) |
| | 1 magazine, 12 rounds | AC20 (10) AB45 (2) | 29 |
| TOWER | | SOLDIER ACTION | |
| WEAPONS SAFETY STATUS RED | <i>Although the firer's slide should be locked to the rear, the tower must treat all firers in a RED status.</i> | | Soldier remains at the READY and may RELOAD or await instructions. |
| CONTROL | RELOAD FIGHT UP | The Soldier conducts an emergency RELOAD and assumes the standing position and prepares to move out. | |
| TOWER AWAITS THE END OF THE 10 SECOND TRANSITION THEN PROCEEDS | | | |
| WEAPONS SAFETY STATUS REMAINS RED | | | |
| CONTROL | MOVE OUT | Soldier moves out at a slow, deliberate pace. | |
| EXECUTION | ENGAGE UPON POSITIVE IDENTIFICATION | | Soldier acquires, prioritizes, and engages targets with one round per target. If a malfunction occurs, firer clears the malfunction and continues until the task is complete. |
| TOWER AWAITS COMPLETION OF ENGAGEMENT 23 THEN PROCEEDS | | | |
| WEAPONS SAFETY STATUS REMAINS RED | | | |
| Note: There is a 2-second delay between all target engagements throughout this table. | | | |
| Legend: DODIC – Department of Defense identification code | | | |

D-58. A lane safety clears the firers upon their completion of Table V training and collecting their dunnage. A lane safety verifies the clearing prior to the Soldier moving from the firing point. Once cleared, the lane safety communicates the WSS to the tower operator and the tower operator issues an administrative command moving the completed Soldiers off the range. Table D-39 illustrates an example of this command.

Table D-39. Table V, completed firing order, conduct of the range example

| <i>Firing Order Complete</i> | | | |
|--|---|--|----------------|
| | Task | Target | Target Type |
| FIRING ORDER COMPLETE | Completed Firing Order | N/A | N/A |
| | Rounds per Target | DODIC | Time (Seconds) |
| | N/A | N/A | NO LIMIT |
| TOWER | SOLDIER ACTION | | |
| TOWER MUST ASSUME ALL FIRERS' WEAPON SAFETY STATUS IS RED | | | |
| TERMINATION | CEASE FIRE CEASE FIRE | Soldiers stop firing and place weapons on SAFE. | |
| WEAPONS SAFETY STATUS GREEN | GO GREEN GO GREEN | Soldiers clear their weapon and wait to be inspected by a lane safety prior to holstering. | |
| | ONCE VERIFIED BY THE RSO, HOLSTER | | |
| CONDUCT OF THE RANGE | FIRERS SECURE YOUR DUNNAGE MOVE TO THE BASELINE. | Firers secure weapon and ammunition dunnage and move to the designated location. | |
| Once all firers return to the baseline, tower directs the firing order off the range to the designated dunnage download point. | | | |
| Legend: DODIC – Department of Defense identification code, N/A – not applicable, RSO – range safety officer | | | |

D-59. Lane safeties annotate the completion of Table V training on DA Form 7814. As soon as the completed firing order is clear, the tower operator can move a new firing order into position. The tower operator repeats this process until all firers have completed Table V, Practice, training.

PISTOL, TABLE VI, QUALIFICATION, STAGE 1 DAY FIRE

D-60. All Soldiers assigned an M9-, M17-, or M18-series pistol on the unit's MAL execute Table VI, Qualification. The Soldier must achieve at least 70 percent of the targets presented to qualify. Failing to pass this table indicates the Soldier's lack of proficiency when applying the functional elements of the shot process or target acquisition skills.

D-61. Table VI, Qualification, is the commander's assessment of the Soldier's weapons proficiency. The assessment serves as an evaluation of the Soldier's ability to engage and destroy single and multiple enemy targets with a pistol. In a timed scenario, the firer demonstrates their experience, efficiency, and understanding of target acquisition, target prioritization, and their ability to conduct rapid reloads while stationary or moving. Leaders conduct Table VI training on a CPQC. Soldiers fire the tasks in three phases: standing, kneeling, and while moving.

Note. Soldiers who fail the qualifying tasks in Pistol, Table VI, Qualification, may not use a pistol during any live-fire collective training events.

TASK, CONDITIONS, AND STANDARDS

D-62. Table D-40 shows the task, conditions, and standard for conducting Pistol, Table VI, Qualification training. The firer conducting the even should know the task, conditions, and standard and explains them during the range briefing. The firer explains the task, conditions, and standards

Table D-40. Pistol, Table VI, Qualification

| | |
|--------------------|---|
| Task: | Engage and defeat single and multiple stationary threats at varying ranges during day and limited visibility conditions while stationary or moving, using ball ammunition. |
| Conditions: | Given the following: <ul style="list-style-type: none"> • Fully mission capable weapon as assigned on the master authorization list for the unit. • Full combat uniform, issued equipment, and protective mask (if assigned). • Authorized range facility. • Full-scale, approved targetry in standard scenario sequence. • Authorized ammunition. |
| Standard: | Demonstrate engagement proficiency by hitting 70 percent (21 of 30) of all presented targets in the time allotted. |

D-63. Table D-41 shows the training event design template for Pistol Table VI, Qualification. This unit conducts this event on an authorized live-fire facility, typically a CPQC. See TC 25-8 for additional information on authorized range facilities.

Table D-41. Training event design template for Pistol, Table VI, Qualification

| <i>Pistol, Table VI, Qualification</i> <i>Live-Fire Proficiency Gate</i> | | | | | | | |
|---|---------------|---------------------------|-------------------------|---------------------------------------|--------------------------|---------------------------------|-------------|
| EVENT NAME: | QUALIFICATION | ENVIRONMENT: | | LIVE | 1.0 | | |
| WEAPON: | M9, M17, M18 | CONDITIONS: | | LIVE FIRE | | | |
| CATEGORY: | FOUNDATION | PRIMARY FACILITY: | | CPQC | DAYS REQUIRED | | |
| PUBLICATION: | TC 3-23.35 | ALTERNATE FACILITY: | | QTR | | | |
| REQUIRED: | YES | COMPONENT: | AC | RC | 120 SOLDIERS | | |
| EXTERNAL EVAL: | PLATOON | FREQUENCY: | 2 | 1 | | | |
| VALID FOR: | 12 MONTHS | ANNUAL DAYS TOTAL: | 2 | 1 | THROUGHPUT | | |
| TABLE | | | | | | | |
| | | I | II | III | IV | V | VI |
| | | PMI&E | PLFS | DRILLS | BASIC | PRACTICE | QUAL |
| | | PRQ | PRQ | PRQ | | | REQUIRED |
| WHEN EXECUTED: | | | | | | | T-X |
| CONDEMNATION CRITERIA (CC) | RULE 1 | RULE 2 | RULE 3 | RULE 4 | RULE 5 | RULE 6 | |
| | TIME | KEY LEADER TURNOVER | COMMANDER ASSESSMENT | SUBORDINATE ELEMENT PROFICIENCY | SPECIALTY PROFICIENCY | STAFF SECTION PROFICIENCY | |
| Remarks: Each Soldier assigned an individual weapon <i>must</i> successfully complete Table VI, Qualification to meet their live-fire proficiency gate. The live-fire proficiency gate is required for any Soldier to participate in <i>any collective live-fire event</i> . | | | | | | | |
| Note: Table III should be used as concurrent training on Tables IV, V, and VI while Soldiers are awaiting training in a firing order or between day and night phases. | | | | | | | |
| Legend: AC – active component (known as active duty), ARF – automated record fire range, CPQC – automated combat pistol qualification course, EVAL – evaluation, MRF – modified record fire range or similar, PLFS – preliminary live-fire simulation, PMI&E – preliminary marksmanship instruction and evaluation, PRQ – prerequisite, QTR – qualification training range, QUAL – qualification, RC – Reserve Component (known as Reserves), T-X – training event exercise, TC – training circular, TNG – training, TNG DAYS TO QUAL – number of training days remaining on the critical path to weapon's qualification | | | | | | | |

AMMUNITION

D-64. All Soldiers assigned a pistol on a unit MAL complete Pistol, Table VI training prior to advancing to collective training. Units conduct the tasks in Pistol, Table VI, Qualification to demonstrate whether the Soldier has the proficiency to employ a pistol during a close quarters fight.

D-65. To effectively plan and forecast for sufficient training ammunition, the unit uses the ammunition requirements listed in table D-42, on page D-38. Units need to identify the total number of firers and should plan for unscheduled firers and necessary retraining by increasing their forecasted training ammunition as appropriate.

Table D-42. Table VI, Qualification ammunition requirements

| <i>Pistol Event</i> | <i>DODIC</i> | <i>Nomenclature</i> | <i>Quantity</i> | <i>Remarks</i> |
|---------------------|--------------|---|-----------------|--|
| Qualification | AC20 | CTG, 9mm F/M17 and M18, Military Pack Full Metal Jacket (FMJ) | 30 | One round is authorized for each target presented. |

Legend: CTG – cartridge, DODIC – Department of Defense identification code, mm – millimeter

D-66. Table VI is an automated, timed event that consists of three phases: Standing, kneeling, and moving. Units issue ammunition to every firer as shown in table D-43 for the conduct of Pistol, Table VI, Qualification training. Firers place these magazines in their magazine pouches. Staging or pre-positioning magazines is not authorized for the conduct of Table VI training.

Table D-43. Pistol Table VI, Qualification ammunition breakdown

| <i>Phase</i> | <i>Targets</i> | <i>Rounds per Target</i> | <i>Ammunition Breakdown</i> | |
|--------------|----------------|--------------------------|-----------------------------|----------------------------|
| | | | <i>Magazines</i> | <i>Rounds per Magazine</i> |
| Standing | 10 | 1 | 1 | 10 |
| Kneeling | 10 | 1 | 1 | 10 |
| Moving | 10 | 1 | 1 | 10 |

Note. If the unit does not have access to an approved simulation system, the Soldier must also complete the tasks in Pistol, Table VI, Qualification CBRN and Pistol, Table VI, Qualification, Night.

RANGE FACILITIES

D-67. Table D-44 shows the Army-standard range facilities specifically designed to support Table VI, Qualification training. Units must refer to their installation's range operations SOPs or local training regulation to identify the weapon specific range facilities. Units use their RFMSS system for all scheduling.

Table D-44. Pistol Table VI, Qualification authorized range facilities

| <i>Table VI</i> | <i>Target</i> | <i>Range Facility</i> | |
|-----------------|--|-----------------------|-------------|
| | | <i>CPQC</i> | <i>Zero</i> |
| Qualification | E-type, E1, target, silhouette: plastic, polyethylene, kneeling, (NSN: 6920-00-071-4780) | P | A |

Legend: A – alternate, CPQC – combat pistol qualification course, NSN – national stock number, P – primary, Zero – basic 10-meter / 25-meter firing range (zero)

TARGETRY

D-68. Table VI requires silhouette targetry, either E-type or D-type targets on the range. The leader must confirm the type and capability of the range's targetry, lifting mechanisms, and simulators and identify any unit requirements. During the preparation phase, leaders should be familiar with the targetry used, and the sequence of the firing events. Figure D-3 shows the E-type and D-type targets used during Table VI raining.



| <p align="center">E-1 Target, silhouette: plastic, polyethylene, kneeling NSN 6920-00-071-4780</p> | <p align="center">D-1 Target, 3-dimensional: plastic, mannequin, kneeling NSN 6920-01-164-9625</p> |
|--|---|
|  |  |
| <p>Use of E-1 or D-1 kneeling targets is at the discretion of the installation. Both represent dismounted, kneeling Infantry targets on small arms and maneuver facilities.</p> <p>Use of F-type or G-2 prone targets is not authorized.</p> | |
| <p>Legend: NSN – national stock number</p> | |

Figure D-3. Table VI, authorized target types

SCENARIO ENGAGEMENTS

D-69. Targets are presented to the firer in single and double target arrays. Targets are presented so that 90 percent of the target is clearly visible to the firer from the expected firing position. Targets are presented as follows:

- Single targets are exposed for 3 seconds.
- Double target presentations are exposed for 5 seconds.

D-70. Ten second transition delay periods occur at the end of each phase to provide the firer time to conduct an emergency reload and assume the next specified position. Tables D-45 through D-47, pages D-40 through D-42, show engagement sequence by phase for Table V training.

Table D-45. Pistol, Table VI, Qualification target engagement sequence

| <i>Table VI, Practice, Engagements 1 through 9, Standing, Baseline</i> | | | |
|---|--------------------|-----------------------|--------------------------------|
| <i>Engagement</i> | <i>Target Type</i> | <i>Range (meters)</i> | <i>Exposure Time (seconds)</i> |
| 1 | E-type | 7 LEFT | 5 |
| 2 | E-type | 12.5 | 5 |
| 3 | E-type | 23 | 5 |
| 4 | E-type | 31 | 5 |
| 5 | E-type | 10 | 5 |
| 6 | E-type | 16.5 | 5 |
| 7 | E-type | 27 | 5 |
| 8 | E-type | 7 RIGHT | 5 |
| 9 | E-type | 10 | 8 |
| | E-type | 12.5 | |
| Note: There is a 2-second delay between all target engagements throughout this table. At the end of the engagement 9, a 10-second delay is integrated for magazine change. | | | |

Table D-46. Pistol, Table VI, Qualification, engagement 10 through 17 sequence

| <i>Table VI, Practice, Engagements 10 through 17, Kneeling, Baseline</i> | | | |
|--|--------------------|-----------------------|--------------------------------|
| <i>Engagement</i> | <i>Target Type</i> | <i>Range (meters)</i> | <i>Exposure Time (seconds)</i> |
| 10 | E-type | 23 | 5 |
| 11 | E-type | 31 | 5 |
| 12 | E-type | 16.5 | 5 |
| 13 | E-type | 27 | 5 |
| 14 | E-type | 7 RIGHT | 8 |
| | E-type | 10 | |
| 15 | E-type | 12.5 | 5 |
| 16 | E-type | 23 | 5 |
| 17 | E-type | 16.5 | 8 |
| | E-type | 12.5 | |

Note: There is a 2-second delay between all target engagements throughout this table.
At the end of the engagement 17, a 10-second delay is integrated for magazine change.

Table D-47. Pistol, Table VI, Qualification, engagement 18 through 23 sequence

| <i>Table VI, Practice, Engagements 18 through 23, Moving, Footpath</i> | | | |
|--|--------------------|-----------------------|--------------------------------|
| <i>Engagement</i> | <i>Target Type</i> | <i>Range (meters)</i> | <i>Exposure Time (seconds)</i> |
| 18 | E-type | 7 LEFT | 8 |
| | E-type | 7 RIGHT | |
| 19 | E-type | 10 | 8 |
| | E-type | 12.5 | |
| 20 | E-type | 16.5 | 8 |
| | E-type | 23 | |
| 21 | E-type | 23 | 8 |
| | E-type | 27 | |
| 22 | E-type | 27 | 5 |
| 23 | E-type | 31 | 5 |
| Note: There is a 2-second delay between all target engagements throughout this table. | | | |

CONDUCT OF THE RANGE

D-71. Leaders instruct Soldiers on the objectives of tasks in Table VI and the importance of the functional elements of the shot process. Table VI contains 23 firing tasks with an administrative pause programmed at the end of each phase to facilitate emergency reloading and changing positions.

D-72. Soldiers enter the range and move to their firing points. Once at the firing point, firers assume a standing firing position with pistols holstered in a green status. Firers fire the tasks in Table VI from the ready throughout the duration of the course of fire, where—

- Tasks 1 through 9 are fired from the standing unsupported position.
- Tasks 10 through 17 are fired from the kneeling position.
- Tasks 18 through 23 are fired as the Soldier moves down the 1 meter wide 10 meter in length walk path.

D-73. Soldiers enter the range and move to their firing points. Once at the firing point, firers assume a standing firing position with pistols in holsters. Soldiers fire according to the tasks in Table VI from the ready for each task.

D-74. Soldiers begin Table VI training by moving into the firing position with the use of administrative commands from the tower operator. Tower operators use administrative commands to control the flow of the range, movement of personnel, and other command and control purposes. Table D-48 provides an example of the administrative commands for moving a new firing order into position.

Table D-48. Table VI, New Firing Order, conduct of the range example

| <i>New Firing Order Conduct of the Range</i> | | | |
|--|---|---|----------------|
| QUALIFICATION | Task | Target | Target Type |
| | New Firing Order | N/A | N/A |
| | Rounds per Target | DODIC | Time (Seconds) |
| | N/A | AC20 | NO LIMIT |
| TOWER | | SOLDIER ACTION | |
| CONDUCT OF THE RANGE | FIRING ORDER (ONE) HOLSTER YOUR WEAPON SECURE YOUR AMMUNITION AND MOVE TO YOUR ASSIGNED FIRING POINT | Soldiers holster their weapon in a GREEN status, secure ammunition in three magazines, and move to the designated firing point. | |
| Tower waits for all Soldiers to reach firing point prior to continuing. | | | |
| Legend: DODIC – Department of Defense identification code, N/A – not applicable | | | |

D-75. As soon as the tower confirms all firers are at the appropriate firing point the tower operator proceeds to the first engagement. Tables D-49 through D-52, on pages D-44 through D-47, provide the engagement sequence with a generic conduct of fire process for the tower operator.

Table D-49. Table VI, engagement 1 through 9, conduct of fire example

| <i>Engagement 1 through 9 – Day Fire, Standing, 1 Magazine (10-rounds)</i> | | | |
|---|--|--|-----------------------|
| | Engagement | Target | Target Type |
| | 1 through 9 | E-1 | Point |
| | Rounds | DODIC | Time (Seconds) |
| | 1 magazine 10 rounds | AC20 | 48 |
| TOWER | | SOLDIER ACTION | |
| FIRERS, | | | |
| WEAPONS SAFETY STATUS RED | ONE TEN-ROUND MAGAZINE | Soldier draws pistol and loads one 10-round magazine, ensuring weapon is on SAFE and remains at the ready. | |
| MAKE READY | | | |
| ALERT | CONTACT | | |
| TARGET DESCRIPTION | MULTIPLE ENEMY TROOPS | | |
| DIRECTION | FRONT | | |
| RANGE | CLOSE QUARTERS | | |
| METHOD | NEAR TO FAR | | |
| CONTROL | WEAPONS FREE WEAPONS FREE | | |
| EXECUTION | ENGAGE UPON POSITIVE IDENTIFICATION | Soldier acquires, prioritizes, and engages targets with one round per target. If a malfunction occurs, firer clears the malfunction and continues until the task is complete. Soldier reloads when required. | |
| TOWER AWAITS COMPLETION OF ENGAGEMENT 9 THEN PROCEEDS IMMEDIATELY | | | |
| WEAPONS SAFETY STATUS REMAINS RED | | | |
| Note: There is a 2-second delay between all engagements. A 10-second delay is integrated after the last engagement for reloading procedures and change of firing position. | | | |
| Legend: DODIC – Department of Defense identification code | | | |

Table D-50. Table VI, engagement 10 through 17, conduct of fire example

| <i>Engagement 10 through 17 – Day Fire, Kneeling, 1 Magazine (10-rounds)</i> | | | |
|--|-----------------------|--|-----------------------|
| | Engagement | Target | Target Type |
| | 10 through 17 | E-1 | Point |
| | Rounds | DODIC | Time (Seconds) |
| | 1 magazine, 10 rounds | AC20 | 46 |
| TOWER | | SOLDIER ACTION | |
| WEAPONS SAFETY STATUS RED <i>Although the firer's slide should be locked to the rear, the tower must treat all firers in a RED status.</i> | | Soldier remains at the READY and may RELOAD or await instructions. | |
| CONTROL RELOAD FIGHT DOWN | | The Soldier assumes the kneeling position and prepares to engage. If a malfunction occurs, firer clears the malfunction and continues until the task is complete. Firer conducts emergency RELOAD as required. | |
| TOWER AWAITS THE END OF THE 10 SECOND TRANSITION AND THEN PROCEEDS | | | |
| WEAPONS SAFETY STATUS REMAINS RED | | | |
| EXECUTION ENGAGE UPON POSITIVE IDENTIFICATION | | Soldier acquires, prioritizes, and engages targets with one round per target. If a malfunction occurs, firer clears the malfunction and continues until the task is complete. Soldier reloads when required. | |
| TOWER AWAITS COMPLETION OF TASK 17 THEN PROCEEDS IMMEDIATELY | | | |
| WEAPONS SAFETY STATUS REMAINS RED | | | |
| Note: There is a two second delay between all engagements. At the end of engagement 17, a 10 second pause is integrated for the firer to execute an emergency reload. | | | |
| Legend: DODIC – Department of Defense identification code | | | |

Table D-51. Table V, engagement 18 through 23, conduct of fire example

| <i>Engagement 18 through 23 – Day Fire, Moving, 1 Magazine (10-rounds)</i> | | | |
|---|--|--|-----------------------|
| | Engagement | Target | Target Type |
| | 18 through 23 | E-1 | Point |
| | Rounds | DODIC | Time (Seconds) |
| | 1 magazine, 10 rounds | AC20 | 42 |
| TOWER | | SOLDIER ACTION | |
| WEAPONS SAFETY STATUS RED | | <p><i>Although the firer's slide should be locked to the rear, the tower must treat all firers in a RED status.</i></p> <p>Soldier remains at the READY and may RELOAD or await instructions.</p> | |
| CONTROL | RELOAD FIGHT UP | The firer conducts an emergency RELOAD, assumes the standing position, and prepares for tactical movement. | |
| TOWER AWAITS THE END OF THE 10 SECOND TRANSITION AND THEN PROCEEDS | | | |
| WEAPONS SAFETY STATUS REMAINS RED | | | |
| CONTROL | MOVE OUT | Soldier begins slow, deliberate movement down the 8m /10 m walk path. | |
| EXECUTION | ENGAGE UPON POSITIVE IDENTIFICATION | Soldier acquires, prioritizes, and engages targets with one round per target. If a malfunction occurs, firer clears the malfunction and continues until the task is complete. Soldier reloads when required. | |
| TOWER PROCEEDS ONCE FIRERS ARE COMPLETE WITH ENGAGEMENT 23 | | | |
| Note: There is a two second delay between engagements. | | | |
| Legend: DODIC – Department of Defense identification code, m – meter | | | |

Table D-52. Table VI, Completed Firing Order, conduct of the range example

| Completed Firing Order, Conduct of the Range | | | |
|---|---|--|-----------------------|
| | Task | Target | Target Type |
| FIRING ORDER COMPLETE | Completed Firing Order | N/A | N/A |
| | Rounds per Target | DODIC | Time (Seconds) |
| | N/A | N/A | NO LIMIT |
| TOWER | | SOLDIER ACTION | |
| TOWER MUST ASSUME ALL FIRERS WEAPONS SAFETY STATUS IS RED | | | |
| TERMINATION | CEASE FIRE CEASE FIRE | Soldiers stop firing and place weapons on SAFE. | |
| WEAPONS SAFETY STATUS GREEN | GO GREEN GO GREEN ONCE VERIFIED BY RSO, HOLSTER | Soldiers Clear their weapon and wait to be inspected by a lane safety prior to holstering. | |
| CONDUCT OF THE RANGE | FIRERS SECURE YOUR DUNNAGE MOVE TO THE BASELINE | Firers secure weapon and ammunition dunnage and move to the designated location. | |
| Once GREEN status is verified, tower directs the firing order off the range to the designated dunnage download point. | | | |
| Legend: DODIC – Department of Defense identification code, N/A – not applicable, RSO – range safety officer | | | |

PISTOL, TABLE VI, STAGE 2, CBRN

D-76. The task in Pistol, Table VI, CBRN is a pistol qualification event requirement. Leaders use Pistol, Table VI to train and evaluate the firer's ability to engage targets while operating with individual chemical protective equipment. At a minimum, Soldiers must fire this course while wearing individual combat equipment and a protective mask with hood. All Soldier's assigned a pistol must complete this course of fire as part of their qualification based on their access to primary simulations systems. (See table D-53, on page D-48.)

Table D-53. Table VI, Qualification, Chemical, Biological, Radiological, and Nuclear execution based on virtual system availability

| Supported / Available System | Authorized As | Qualification Environment Required | |
|---|---------------|------------------------------------|------------------|
| | | Virtual | Live (Live-Fire) |
| Soldier / squad virtual training system (S / SVT) | Primary | X | |
| Engagement skills trainer (EST) | Alternate | X | |
| None Available | Live-Fire | | X |

D-77. All firers that have access to an authorized primary or alternate simulation system are not authorized training ammunition to conduct this event in a live environment under live-fire conditions. Units that have secured resources may use the live-fire CBRN qualification for record.

D-78. Stage 2 is only for units that do not have access to an authorized simulator system based on the system’s basis of issue plan. Failure to coordinate for or conduct the CBRN qualification in a designated and authorized system does not authorize training ammunition for this event.

TASK, CONDITIONS, AND STANDARDS

D-79. Soldiers place targets in a tactical array at close quarter’s distances. The CBRN course of fire is a requirement for pistol qualification. CBRN fire challenges firers with single and multiple stationary targets from the standing firing position within the effective range of the weapon.

D-80. Table D-54 outlines the tasks, conditions, and standards for the conduct of the task in Table VI, Qualification, CBRN. When authorized simulations systems are available, training is conducted and recorded using an authorized device during Pistol, Table II, Preliminary Live-Fire Simulations.

Table D-54. Pistol Table VI, Qualification, Chemical, Biological, Radiological, and Nuclear

| | |
|--------------------|--|
| Task: | Engage and defeat single and multiple threats at varying ranges while stationary during day using ball ammunition. |
| Conditions: | Given the following: <ul style="list-style-type: none"> • Fully mission capable weapon as assigned on the master authorization list for the unit. • Full combat uniform, issued equipment, and protective mask. • Authorized range facility and approved targetry. • Full-scale targetry in standard scenario sequences. • Authorized ammunition. |
| Standard: | The Soldier must demonstrate engagement proficiency by hitting 70 percent (five of seven) of all presented targets in the time allotted. |

D-81. Table D-55 shows the training event design template for Pistol, Table VI, Qualification, CBRN. Normally, units conduct this event during Table II training for units that have access to approved simulations systems. Units that do not have access to an approved simulator have authorization to conduct this course of fire on a live-fire facility, typically a CPQC. See TC 25-8 for additional information on authorized range facilities.

Table D-55. Training event design template for Pistol, Table VI, Qualification, Chemical, Biological, Radiological, and Nuclear

| <i>Pistol, Table VI, Qualification Chemical, Biological, Radiological, and Nuclear (CBRN)</i> | | | | | | | |
|---|---------------|---------------------------|-------------------------|---------------------------------------|--------------------------|---------------------------------|-----------------|
| EVENT NAME: | QUALIFICATION | ENVIRONMENT: | | LIVE | 1.0 | | |
| WEAPON: | M9, M17, M18 | CONDITIONS: | | LIVE FIRE | | | |
| CATEGORY: | FOUNDATION | PRIMARY FACILITY: | | CPQC | DAYS REQUIRED | | |
| PUBLICATION: | TC 3-23.35 | ALTERNATE FACILITY: | | QTR | | | |
| REQUIRED: | YES | COMPONENT: | AC | RC | 120 SOLDIERS | | |
| EXTERNAL EVAL: | PLATOON | FREQUENCY: | 2 | 1 | | | |
| VALID FOR: | T-X | ANNUAL DAYS TOTAL: | 2 | 1 | THROUGHPUT | | |
| TABLE | | | | | | | |
| | | I | II | III | IV | V | VI |
| | | PMI&E | PLFS | DRILLS | BASIC | PRACTICE | QUAL |
| | | PRQ | PRQ | PRQ | | | REQUIRED |
| WHEN EXECUTED: | | | | | | | T-X |
| CONDEMNATION CRITERIA (CC) | RULE 1 | RULE 2 | RULE 3 | RULE 4 | RULE 5 | RULE 6 | |
| | TIME | KEY LEADER TURNOVER | COMMANDER ASSESSMENT | SUBORDINATE ELEMENT PROFICIENCY | SPECIALTY PROFICIENCY | STAFF SECTION PROFICIENCY | |
| Remarks: Each Soldier assigned an individual weapon <i>must</i> successfully complete Table VI, Qualification, CBRN, as part of their pistol qualifications. It is primarily fired in an authorized simulation system, when available. When a primary or alternate simulation system is not available, the firer is authorized to conduct this event in a live environment, under live-fire conditions. | | | | | | | |
| Note: Table III should be used as concurrent training on Tables IV, V, and VI while Soldiers are awaiting training in a firing order or between day and night phases. | | | | | | | |
| Legend: AC – active component (known as active duty), ARF – automated record fire range, CPQC – automated combat pistol qualification course, EVAL – evaluation, MRF – modified record fire range or similar, PLFS – preliminary live-fire simulation, PMI&E – preliminary marksmanship instruction and evaluation, PRQ – prerequisite, QTR – qualification training range, QUAL – qualification, RC – Reserve Component (known as Reserves), T-X – training event exercise, TC – training circular, TNG DAYS TO QUAL – number of training days remaining on the critical path to weapon’s qualification | | | | | | | |

AMMUNITION

D-82. To effectively plan and forecast for sufficient training ammunition, the unit uses the ammunition requirements listed in table D-56, on page D-50. Units need to identify the total number of firers and should plan for unscheduled firers and necessary retraining by increasing their forecasted training ammunition as appropriate. Firers place these magazines in their magazine pouches. Firers are not authorized staging or pre-positioning magazines for the conduct of Table VI, CBRN training.

Table D-56. Table VI, Qualification, Chemical, Biological, Radiological, and Nuclear ammunition requirements

| <i>Magazine</i> | <i>DODIC</i> | <i>Nomenclature</i> | <i>Quantity</i> | <i>Remarks</i> |
|--|--------------|---|-----------------|---|
| 1 | AC20 | CTG, 9mm F/M17 and M18, military pack full metal jacket (FMJ) | 7 | One round per target presented is required. |
| Legend: CBRN – chemical, biological, radiological, and nuclear, CTG – cartridge, DODIC – Department of Defense identification code, mm – millimeter | | | | |

RANGE FACILITIES

D-83. Units must refer to their installation's range operations SOPs or local training regulation to identify the weapon specific range facilities. Table D-57 shows the Army-standard range facilities specifically designed to support Table VI, Qualification, CBRN training. Units use their RFMSS system for all scheduling.

Table D-57. Pistol Table VI, Qualification, Chemical, Biological, Radiological, and Nuclear authorized range facilities

| <i>Table VI, Qualification, CBRN</i> | <i>Target</i> | <i>Range Facility</i> | |
|---|--|-----------------------|------------|
| | | <i>CPQC</i> | <i>QTR</i> |
| Qualification | E-type, E1, target, silhouette: plastic, polyethylene, kneeling (NSN: 6920-00-071-4780) | P | A |
| Legend: A – alternate, CBRN – chemical, biological, radiological, and nuclear, CPQC – combat pistol qualification course, NSN – national stock number, P – primary, QTR – qualification training range | | | |

D-84. All Soldiers assigned an M9-, M17-, or M18-series pistol on the unit's MAL must execute Table VI, Qualification, CBRN, either virtually or under live-fire conditions, based on authorized simulations availability. Units issue Soldiers specified amounts of ammunition as depicted in table D-56. The leader is the primary instructor and evaluator. The leader must be afforded the opportunity to research, develop, or secure training materials, and train their Soldiers on the critical tasks in a dry environment prior to executing the training in Table VI, Qualification, CBRN.

TARGETRY

D-85. Table VI, Qualification, CBRN training requires E-type targets on the range. The leader must confirm the type and capability of the range's targetry, lifting mechanisms, simulators and identify any unit requirements. During the preparation phase, leaders should be familiar with the targetry used, and the sequence of the firing events. Figure D-4 shows the E-type target used during Table VI, Qualification, CBRN training.



| <p style="text-align: center;">E-1 Target, silhouette: plastic, polyethylene, kneeling NSN 6920-00-071-4780</p> | <p style="text-align: center;">D-1 Target, 3-dimensional: plastic, mannequin, kneeling NSN 6920-01-164-9625</p> |
|--|--|
|  |  |
| <p>Use of the E-1 or D-1 kneeling targets is at the discretion of the installation. Both represent dismounted, kneeling Infantry targets on small arms and maneuver facilities.</p> <p>Use of the F-type or G-2 prone targets is not authorized.</p> | |
| <p>Legend: NSN – national stock number</p> | |

Figure D-4. Table VI, Qualification, CBRN, authorized targets

SCENARIO ENGAGEMENTS

D-86. Targets are presented to the firer in single and double target arrays. Single targets are exposed for 10 seconds. Double target presentations are exposed for 20 seconds. Table D-58, on page D-52, provides the engagement sequence, range to target, and target exposure time requirements. There are no alterations authorized for these engagements.

Table D-58. Pistol, Table VI, Qualification, Chemical, Biological, Radiological, and Nuclear target engagement sequence

| <i>Engagement</i> | <i>Target Type</i> | <i>Range (meters)</i> | <i>Exposure Time (seconds)</i> |
|---|--------------------|-----------------------|--------------------------------|
| 1 | E-type | 7 LEFT | 10 |
| 2 | E-type | 12.5 | 10 |
| 3 | E-type | 23 | 10 |
| 4 | E-type | 31 | 10 |
| 5 | E-type | 10 | 10 |
| 6 | E-type | 10 | 20 |
| | E-type | 12.5 | |
| <p>Note: There is a 2- second delay between target exposures for this engagement sequence.</p> | | | |



CONDUCT OF THE RANGE

D-87. Units instruct Soldiers on the objectives in Table VI, Qualification, CBRN and the importance of the functional elements of the shot process. Units conduct the task in Table VI, Qualification, CBRN in two administrative and six firing tasks. Firers must hit a minimum of five of the seven targets presented (70 percent) to successfully pass this table.

D-88. Soldiers begin the tasks in Table VI, Qualification, CBRN by moving into the firing position at the direction of the tower operator’s administrative commands. Soldiers enter the range and move to their firing points. Once at the firing point, firers assume a standing firing position with pistols in holsters. Soldiers fire from the ready throughout the duration of the course of fire according to the tasks in Table VI, Qualification, CBRN.

D-89. Units use administrative commands to control the flow of the range, movement of personnel, and other command and control purposes. Table D-59 provides an example of the administrative commands for moving a new firing order into position.

Table D-59. Table VI, Chemical, Biological, Radiological, and Nuclear, new firing order conduct of the range example

| <i>New Firing Order, Conduct of the Range</i> | | | |
|---|---|--|--|
|  CBRN | Engagement | Target | Target Type |
| | New Firing Order | N/A | N/A |
| | Rounds per Target | DODIC | Time (Seconds) |
| | N/A | AC20 | NO LIMIT |
| TOWER | | SOLDIER ACTION | |
| CONDUCT OF THE RANGE FIRERS, SECURE YOUR WEAPON AND AMMUNITION ONCE COMPLETE, MOVE TO YOUR FIRING POINT | | Soldiers secure weapon in holster, ammunition in magazines, and move to the designated firing point. | |
| ONCE FIRERS ARE SET AT THEIR FIRING POINT, THE TOWER CONTINUES. | | | |
| CONDUCT OF THE RANGE | FIRERS, CHEMICAL AGENTS HAVE BEEN REPORTED IN YOUR AREA GAS GAS GAS |  | Soldiers don their protective equipment. |
| ONCE ALL FIRERS HAVE COMPLETED DONNING PROTECTIVE GEAR, THE TOWER CONTINUES. | | | |
| Legend: CBRN – chemical, biological, radiological and nuclear; DODIC – Department of Defense identification code, N/A – not applicable | | | |

D-90. As soon as the tower operator confirms all firers are at the appropriate firing point and in the proper mission-oriented protective posture (MOPP) level, the tower operator proceeds to the first engagement. Table VI, Qualification, CBRN consists of six engagements. Table D-60 on page D-54 and table D-61 on page D-55, lists the commands for tasks 1 through 6. Firers are authorized one each seven-round magazine to conduct this event.

Table D-60. Table VI, Qualification, Chemical, Biological, Radiological, and Nuclear, conduct of fire

| Table VI, Qualification, Day Fire, CBRN Engagement 1, Standing, Baseline | | | |
|--|-------------------|--|----------------|
| | Engagement | Target | Target Type |
| | 1 to 6 | E-1 | Point |
| | Rounds per Target | DODIC | Time (Seconds) |
| | 1 | AC20 | 70 |
| TOWER | | SOLDIER ACTION | |
| WEAPONS SAFETY STATUS RED | | FIRERS, SECURE ONE SEVEN-ROUND MAGAZINE MAKE READY | |
| ALERT | | CONTACT | |
| TARGET DESCRIPTION | | MULTIPLE TROOPS | |
| DIRECTION | | FRONT | |
| RANGE | | CLOSE QUARTERS | |
| METHOD | | NEAR TO FAR | |
| CONTROL | | WEAPONS FREE WEAPONS FREE | |
| EXECUTION | | ENGAGE WHEN POSITIVELY IDENTIFIED | |
| | | Soldier acquires targets, prioritizes targets, and engages targets with one round per target. If a malfunction occurs, firer clears the malfunction and continues until the phase is complete. | |
| ONCE ALL FIRERS ARE COMPLETE, TOWER CONTINUES. | | | |
| WEAPONS SAFETY STATUS REMAINS RED | | | |
| Legend: CBRN – chemical, biological, radiological and nuclear; DODIC – Department of Defense identification code, m – meter | | | |

Table D-61. Table VI, Qualification, Chemical, Biological, Radiological, and Nuclear, completed firing order, conduct of the range example

| <i>Completed Firing Order, Conduct of the Range</i> | | | |
|---|--|--|----------------|
| | Engagement | Target | Target Type |
|  CBRN | Completed Firing Order | N/A | N/A |
| | Rounds per Target | DODIC | Time (Seconds) |
| | N/A | N/A | NO LIMIT |
| | TOWER | SOLDIER ACTION | |
| TOWER MUST ASSUME ALL FIRERS WEAPONS SAFETY STATUS IS RED | | | |
| TERMINATION | CEASE FIRE CEASE FIRE | Soldiers stop firing and place weapons on SAFE. | |
| WEAPONS SAFETY STATUS GREEN | GO GREEN GO GREEN ONCE VERIFIED HOLSTER | Soldiers Clear their weapon and wait to be inspected by a lane safety prior to holstering. | |
| ONCE TOWER CONFIRMS ALL WEAPONS ARE GREEN AND CLEAR, TOWER CONTINUES | | | |
| CONDUCT OF THE RANGE | FIRERS ALL CLEAR ALL CLEAR SECURE YOUR DUNNAGE MOVE TO THE ENTRY CONTROL POINT | Firers secure weapon and ammunition dunnage and move to the range's entry control point. | |
| Tower waits for all Soldiers to reach the entry control point (ECP) prior to moving the next firing order into position. | | | |
| Legend: CBRN – chemical, biological, radiological and nuclear; DODIC – Department of Defense identification code, N/A – not applicable | | | |

D-91. A lane safety clears the firers upon their completion of Table VI, Qualification, CBRN training and collecting their dunnage. The RSO or lane safety verifies weapons cleared prior to the Soldier moving from the firing point. Once the lane safety clears all firers, the lane safety communicates the green weapons safety status to the tower operator. The tower operator then issues an administrative command directing the completed Soldiers off the range.

PISTOL, TABLE VI, STAGE 3, NIGHT FIRE

D-92. The purpose of Pistol, Table VI, Qualification, Night Fire is to train the firer to engage targets during periods of limited visibility while wearing night vision goggles. At a minimum, Soldiers are required to fire

this course of fire while wearing individual combat equipment and their assigned night vision device. Targets are placed in a tactical array at close quarter’s distances.

D-93. All Soldier’s assigned a pistol must complete this course of fire as part of their qualification based on their access to primary simulations systems. (See table D-62.)

Table D-62. Table VI, Qualification, Night Fire, execution based on virtual system availability

| <i>Supported / Available System</i> | <i>Authorized As</i> | <i>Environment Training Conducted</i> | |
|---|----------------------|---------------------------------------|-------------------------|
| | | <i>Virtual</i> | <i>Live (Live-Fire)</i> |
| Soldier and squad virtual training system (S / SVT) | Primary | X | |
| Engagement skills trainer (EST) | Alternate | X | |
| None available | None | | X |

D-94. Table D-64 shows the training event design template for Pistol, Table VI, Qualification, Night Fire. This event is normally conducted during Table II for units that have access to approved simulations systems. Units that do not have access to an approved simulator are authorized to conduct this course of fire on a live-fire facility, typically a CPQC. See TC 25-8 for additional information on authorized facilities.

TASK, CONDITIONS, AND STANDARD

D-95. Table D-63 outlines the tasks, conditions, and standards for the conduct of Table VI, Qualification, Night Fire.

Table D-63. Pistol, Table VI, Qualification, Night Fire

| | |
|--------------------|---|
| Task: | Engage and defeat single and multiple threats at varying ranges while stationary during periods of limited visibility using ball ammunition. |
| Conditions: | Given the following: <ul style="list-style-type: none"> • Fully mission capable weapon as assigned on the master authorization list for the unit. • Authorized range facility. • Full-scale, authorized targetry in standard scenario sequences. • Authorized ammunition. • Assigned night vision device |
| Standard: | The Soldier must demonstrate engagement proficiency by hitting 80 percent (4 of 5) of all presented targets in the time allotted. |

Table D-64. Training event design template for Pistol, Table VI, Qualification, Night Fire

| <i>Pistol, Table VI, Qualification Night Fire</i> | | | | | | | |
|--|---------------|---------------------------|-------------------------|---------------------------------------|--------------------------|---------------------------------|-------------|
| EVENT NAME: | QUALIFICATION | ENVIRONMENT: | | LIVE | 1.0 | | |
| WEAPON: | M9, M17, M18 | CONDITIONS: | | LIVE FIRE | | | |
| CATEGORY: | FOUNDATION | PRIMARY FACILITY: | | CPQC | DAYS REQUIRED | | |
| PUBLICATION: | TC 3-23.35 | ALTERNATE FACILITY: | | QTR | | | |
| REQUIRED: | YES | COMPONENT: | AC | RC | 120 SOLDIERS | | |
| EXTERNAL EVAL: | PLATOON | FREQUENCY: | 2 | 1 | | | |
| VALID FOR: | T-X | ANNUAL DAYS TOTAL: | 2 | 1 | THROUGHPUT | | |
| TABLE | | | | | | | |
| | | I | II | III | IV | V | VI |
| | | PMI&E | PLFS | DRILLS | BASIC | PRACTICE | QUAL |
| | | PRQ | PRQ | PRQ | | | REQUIRED |
| WHEN EXECUTED: | | | | | | | T-X |
| CONDEMNATION CRITERIA (CC) | RULE 1 | RULE 2 | RULE 3 | RULE 4 | RULE 5 | RULE 6 | |
| | TIME | KEY LEADER TURNOVER | COMMANDER ASSESSMENT | SUBORDINATE ELEMENT PROFICIENCY | SPECIALTY PROFICIENCY | STAFF SECTION PROFICIENCY | |
| <p>Remarks: Each Soldier assigned an individual weapon <i>must</i> successfully complete Table VI, Qualification, Night Fire, as part of their pistol qualifications. It is conducted in an authorized simulation system, when available. When a primary or alternate simulation system is not available, the firer is authorized to conduct this event in a live environment, under live-fire conditions.</p> | | | | | | | |
| <p>Note: Table III should be used as concurrent training on Tables IV, V, and VI while Soldiers are awaiting training in a firing order or between day and night phases.</p> | | | | | | | |
| <p>Legend: AC – active component (known as active duty), ARF – automated record fire range, CPQC – automated combat pistol qualification course, EVAL – evaluation, MRF – modified record fire range or similar, PLFS – preliminary live-fire simulation, PMI&E – preliminary marksmanship instruction and evaluation, PRQ – prerequisite, QUAL – qualification, QTR – qualification training range, RC – Reserve Component, T-X – training event exercise, TC – training circular, TNG DAYS TO QUAL – number of training days remaining on the critical path to weapon’s qualification</p> | | | | | | | |

AMMUNITION

D-96. To effectively plan and forecast for sufficient training ammunition, the unit uses the ammunition requirements listed in table D-65, on page D-58. Units need to identify the number of firers and should plan for unscheduled firers and necessary retraining by increasing their forecasted training ammunition as appropriate. Firers place these magazines in their magazine pouches. Firers are not authorized staging or pre-positioning magazines for the conduct of Table VI, night fire training.

Table D-65. Table VI, Night Fire ammunition requirements

| <i>Magazine</i> | <i>DODIC</i> | <i>Nomenclature</i> | <i>Quantity</i> | <i>Remarks</i> |
|--|--------------|---|-----------------|--|
| 1 | AC20 | CTG, 9mm F/M17 and M18, military pack full metal jacket (FMJ) | 5 | One round is authorized for each target presented. |
| Legend: CTG – cartridge, DODIC – Department of Defense identification code, mm – millimeter | | | | |

RANGE FACILITIES

D-97. Units must refer to their installation’s range operations SOPs or local training regulation to identify the weapon specific range facilities. Table D-66 shows the Army-standard range facilities designed to support Table VI, Qualification, Night Fire training. Units use their RFMSS system for all scheduling.

Table D-66. Pistol Table VI, Qualification, Night Fire authorized range facilities

| <i>Table VI, Qualification, Night Fire</i> | <i>Target</i> | <i>Range Facility</i> | |
|---|--|-----------------------|------------|
| | | <i>CPQC</i> | <i>QTR</i> |
| Qualification | E-type, E1, target, silhouette: plastic, polyethylene, kneeling, (NSN: 6920-00-071-4780) | P | A |
| Legend: A – alternate, CPQC – combat pistol qualification course, NSN – national stock number, P – primary, QTR – qualification training range | | | |

TARGETRY

D-98. Table VI, Qualification, Night Fire training requires either E-type or D-type targets on the range. The leader must confirm the type and capability of the range’s targetry, lifting mechanisms, and simulators and identify any unit requirements. During the preparation phase, leaders should be familiar with the targetry used, and the sequence of the firing events. Figure D-5 shows the E-type target used during Table VI, Qualification, Night Fire training.



| E-1 Target, silhouette: plastic, polyethylene, kneeling NSN 6920-00-071-4780 | D-1 Target, 3-dimensional: plastic, mannequin, kneeling NSN 6920-01-164-9625 |
|--|---|
|  |  |
| <p>Use of the E-1 or D-1 kneeling targets is at the discretion of the installation. Both represent dismantled, kneeling Infantry targets on small arms and maneuver facilities.</p> <p>Use of the F-type or G-2 prone targets is not authorized.</p> | |
| <p>Legend: NSN – national stock number</p> | |

Figure D-5. E-type target

SCENARIO ENGAGEMENTS

D-99. Targets are presented to the firer in single and double target arrays. Single targets are exposed for 10 seconds. Double target presentations are exposed for 20 seconds. Table D-67 provides the engagement sequence, range to target, and target exposure time requirements. There are no alterations authorized for these engagements.

Table D-67. Pistol Table VI, Qualification, Night Fire target engagement sequence

| Table VI, Qualification, Night Fire, Engagements 1 through 4, Standing | | | |
|--|---------------|---------------------------|------------------------------------|
| Engagement | Target | Range (meters) | Exposure Time (seconds) |
| 1 | E-type | 10 | 10 |
| 2 | E-type | 12.5 | 10 |
| 3 | E-type | 16.5 | 10 |
| 4 | E-type | 7 LEFT | 20 |
| | E-type | 7 RIGHT | |
| <p>Note: There is a 5-second delay between target exposures for this engagement sequence.</p> | | | |

CONDUCT OF THE RANGE

D-100. Soldiers are instructed on the objectives of the task in Table VI, Qualification, Night Fire and the importance of the functional elements of the shot process. Leaders conduct the tasks in Table VI, Qualification, Night Fire in two administrative and four firing tasks. Firers must hit a minimum of three of the five targets presented (60 percent) to successfully pass this table.

D-101. Soldiers begin the tasks in Table VI, night by moving into the firing position with the use of administrative commands from the tower operator. Soldiers enter the range and move to their firing points. Once at the firing point, firers assume a standing firing position with their pistols in their holsters. Soldiers fire from the ready throughout the duration of the course of fire according to Table VI, Qualification, Night Fire.

D-102. Leaders use administrative commands to control the flow of the range, movement of personnel, and other command and control purposes. Table D-68 provides an example of the administrative commands for moving a new firing order into position.

Table D-68. Table VI, Qualification, Night Fire, new firing order, conduct of the range example

| <i>New Firing Order, Conduct of the Range</i> | | | |
|--|--|--|-----------------------|
| NIGHT FIRE | Engagement | Target | Target Type |
| | New Firing Order | N/A | N/A |
| | Rounds per Target | DODIC | Time (Seconds) |
| | N/A | AC20 | NO LIMIT |
| TOWER | | SOLDIER ACTION | |
| FIRERS | | | |
| CONDUCT OF THE RANGE | SECURE YOUR WEAPON AND AMMUNITION ONCE COMPLETE MOVE TO YOUR FIRING POINT | Soldiers secure weapon in holster, ammunition in magazines, and move to the designated firing point. | |
| ONCE ALL FIRERS ARE AT THEIR FIRING POSITIONS, THE TOWER CONTINUES. | | | |
| Legend: DODIC – Department of Defense identification code, N/A – not applicable | | | |

D-103. As soon as the tower confirms all firers are at the appropriate firing point the tower operator proceeds to the next engagement. Table VI, Qualification, Night Fire, has four firing tasks. Table D-69 lists the commands for task 1 through 4. The amount of ammunition required to fire engagement 1 of Table VI, Qualification, Night Fire is one five-round magazine.

Table D-69. Table VI, Qualification, Night Fire engagement 1 through 4

| Table VI, Qualification, Night Fire Engagement 1 through 4 | | | |
|--|--|---|----------------|
| | Engagement | Target | Target Type |
| | 1 to 4 | E-1 | Point |
| | Rounds per Target | DODIC | Time (Seconds) |
| | 1 | AC20 | 50 |
| TOWER | | SOLDIER ACTION | |
| FIRERS, | | | |
| WEAPONS SAFETY STATUS RED | SECURE ONE FIVE-ROUND MAGAZINE | Soldier draws pistol and loads one five-round magazine, ensuring weapon is on SAFE, and remains at the ready. | |
| MAKE READY | | | |
| ALERT | CONTACT | | |
| TARGET DESCRIPTION | MULTIPLE TROOPS | | |
| DIRECTION | FRONT | | |
| RANGE | CLOSE QUARTERS | | |
| METHOD | NEAR TO FAR | | |
| CONTROL | WEAPONS FREE WEAPONS FREE | | |
| EXECUTION | ENGAGE WHEN POSITIVELY IDENTIFIED | Soldier acquires, prioritizes, and engages targets with one round per target. If a malfunction occurs, firer clears the malfunction and continues until the phase is complete. | |
| ONCE ALL FIRERS ARE COMPLETE, TOWER CONTINUES. | | | |
| Legend: DODIC – Department of Defense identification code | | | |

D-104. A lane safety clears the firers upon their completion of Table VI, Qualification, Night Fire training and collecting their dunnage. The lane safety verifies the clearing prior to the Soldier moving from the firing point. Once cleared, the lane safety communicates the WSS to the tower operator and the tower operator issues an administrative command moving the completed Soldiers off the range. Table D-70 is an example of this command.

Table D-70. Table VI, Qualification, Night Fire completed firing order, conduct of the range example

| <i>Completed Firing Order, Conduct of the Range</i> | | | |
|--|---|--|-----------------------|
| NIGHT FIRE | Engagement | Target | Target Type |
| | Completed Firing Order | N/A | N/A |
| | Rounds per Target | DODIC | Time (Seconds) |
| | N/A | N/A | NO LIMIT |
| TOWER | | SOLDIER ACTION | |
| TOWER MUST ASSUME ALL FIRERS WEAPONS SAFETY STATUS IS RED | | | |
| TERMINATION | CEASE FIRE CEASE FIRE | Soldiers stop firing and place weapons on SAFE. | |
| WEAPONS SAFETY STATUS GREEN | GO GREEN GO GREEN ONCE VERIFIED HOLSTER | Soldiers clear their weapon and wait to be inspected by a lane safety prior to holstering. | |
| ONCE ALL FIRERS ARE VERIFIED GREEN, TOWER CONTINUES. | | | |
| CONDUCT OF THE RANGE | FIRERS SECURE YOUR DUNNAGE ONCE COMPLETE, MOVE TO THE ENTRY CONTROL POINT | Firers secure weapon and ammunition dunnage and move to the designated location. | |
| TOWER WAITS FOR ALL SOLDIERS TO REACH THE ENTRY CONTROL POINT PRIOR TO ADVANCING THE NEXT FIRING ORDER TO THE BASELINE. | | | |
| Legend: DODIC – Department of Defense identification code, N/A – not applicable | | | |

PISTOL VALIDATION

D-105. Validation is a commander's option to confirm a rudimentary level of proficiency sufficient to accept reasonable risk by extending an existing QD by six months. The validation event is used in extreme circumstances where the commander must confirm a qualification or certification. These circumstances may arise in garrison and operational environments. See chapter 1, on page 1-21, for detailed information on the use of alternate courses of fire for individual weapons.

TASK, CONDITIONS, AND STANDARDS

D-106. Targets are placed in a tactical array at close quarter's distances. The purpose of the ALT-C is to challenge firers with single stationary targets from the standing, kneeling, and prone firing positions within the effective range of the weapon. Table D-71 outlines the tasks, conditions, and standards for the pistol validation training.

Table D-71. Pistol validation task, conditions, and standard

| | |
|--------------------|--|
| Task: | Validate Soldier's safe use of the M9-, M17-, or M18-series pistol by demonstrating rudimentary engagement skills. |
| Conditions: | Given the following: <ul style="list-style-type: none"> • Fully mission capable weapon, as assigned on the master authorization list for the unit. • Full combat uniform, issued equipment, and protective mask. • Authorized range facility and approved targetry. • Authorized ammunition. |
| Standard: | The Soldier must demonstrate engagement proficiency by effectively hitting 80 percent (8 of 10) from each firing position: standing, kneeling, and prone positions. |

D-107. Table D-72, on page D-64, shows the training event design template for pistol validation. See TC 25-8 for additional information on authorized range facilities.

Table D-72. Training event design template for pistol validation

| <i>Pistol Validation</i> | | | | | | |
|---|---------------|---------------------------|-------------------------|---------------------------------------|--------------------------|---------------------------------|
| <i>Alternate Course of Fire (ALT-C)</i> | | | | | | |
| EVENT NAME: | VALIDATION | ENVIRONMENT: | | LIVE | 1.0 | |
| WEAPON: | M9, M17, M18 | CONDITIONS: | | LIVE FIRE | | |
| CATEGORY: | FOUNDATION | PRIMARY FACILITY: | | Zero | DAYS REQUIRED | |
| PUBLICATION: | TC 3-23.35 | ALTERNATE FACILITY: | | N/A | | |
| REQUIRED: | GO APPROVAL | COMPONENT: | AC | RC | 120 SOLDIERS | |
| EXTERNAL EVAL: | PLATOON | FREQUENCY: | | | | |
| VALID FOR: | QD + 6 | ANNUAL DAYS TOTAL: | | | THROUGHPUT | |
| TABLE | | | | | | |
| | I | II | III | IV | V | VI |
| | PMI&E | PLFS | DRILLS | BASIC | PRACTICE | QUAL |
| | PRQ | PRQ | PRQ | | | VALIDATION |
| WHEN EXECUTED: | | | | | | T-X |
| CONDEMNATION CRITERIA (CC) | RULE 1 | RULE 2 | RULE 3 | RULE 4 | RULE 5 | RULE 6 |
| | TIME | KEY LEADER TURNOVER | COMMANDER ASSESSMENT | SUBORDINATE ELEMENT PROFICIENCY | SPECIALTY PROFICIENCY | STAFF SECTION PROFICIENCY |
| <p>Remarks: Units must have the appropriate approval by their first General Officer (GO) in their chain of command to use any alternate course of fire (ALT-C) for any weapon system.</p> | | | | | | |
| <p>Legend: AC – active component (known as active duty), ARF – automated record fire range, EVAL – evaluation, N/A – not applicable, PLFS – preliminary live-fire simulation, PMI&E – preliminary marksmanship instruction and evaluation, PRQ – prerequisite, QD – qualification duration, QUAL – qualification, RC – Reserve Component (known as Reserves), TC – training circular, T-X – training event exercise, TNG DAYS TO QUAL – number of training days remaining on the critical path to weapon's qualification, Zero – basic 10 meter / 25 meter firing range (zero)</p> | | | | | | |

AMMUNITION

D-108. ALT-C is a static timed event that consists of 3 engagements and 30 rounds. (See table D-73.) Every firer is issued 3 each, 10-round magazines to conduct Pistol, Table VI, Qualification, ALT-C training. Firers place these magazines in their magazine pouches. Staging or pre-positioning magazines is not authorized for the conduct of validation table.

Table D-73. Ammunition requirements by engagement

| <i>Engagement</i> | <i>DODIC</i> | <i>Magazine</i> | <i>Rounds per Magazine</i> |
|--|--------------|-----------------|----------------------------|
| 1 | AC20 | 1 | 10 |
| 2 | AC20 | 1 | 10 |
| 3 | AC20 | 1 | 10 |
| Total Rounds Required: | | | 30 |
| Legend: DODIC – Department of Defense identification code | | | |

RANGE FACILITIES

D-109. Table D-74 shows the Army-standard range facilities designed to support pistol validation. Units must refer to their installation's range operations SOPs or local training regulation to identify the weapon-specific range facilities. Units use their RFMSS system for all scheduling.

Table D-74. Pistol validation authorized range facilities

| <i>Event</i> | <i>Target</i> | <i>Range Facility</i> |
|--|--|-----------------------|
| | | <i>Zero</i> |
| Validation | B1, target, silhouette: bull ring, pistol (NSN: 6920-01-276-6604) | P |
| Legend: NSN – national stock number, P – primary, Zero – basic 10 meter / 25 meter firing range | | |

D-110. All Soldiers assigned an M9-, M17-, or M18-series pistol on the unit's MAL may execute pistol validation when approved by the first general officer in their chain of command. This is NOT a qualification course of fire. Units use this event solely as a risk mitigation tool for the commander to verify basic marksmanship skills of the firer in extreme cases. This does not replace the Army-standard pistol qualification.

TARGETRY

D-111. ALT-C requires the B1 target, silhouette: paper, B-type, M9 pistol 25 meter. This is the only target authorized for the conduct of pistol validation (ALT-C). During the preparation phase, leaders should be familiar with the targetry used, and the firing event sequence. Figure D-6, on page D-66, shows the B1 target used during ALT-C.

| <i>B1 Target, Silhouette: Paper, B-type, Pistol, 25 meter</i> | | |
|--|--------------------------|--|
| Target Type: | B-type (bull's-eye ring) |  |
| Model: | B1 | |
| Construction: | Paper | |
| NSN: | 6920-01-276-6604 | |
| Primary Use: | Pistol, Table VI, ALT-C | |
| Legend: ALT-C – alternate course of fire, NSN – national stock number | | |

Figure D-6. B1 target information

CONDUCT OF THE RANGE

D-112. Leaders instruct Soldiers on the objectives of Table VI, ALT-C and the importance of the functional elements of the shot process. Soldiers conduct ALT-C in two administrative and three firing engagements with an administrative pause between engagements. Firers must hit a minimum of 24 of the 30 rounds fired (80 percent) to successfully validate their existing qualification.

D-113. Soldiers enter the range and move to their firing points 25 meters from the target. Once at the firing point, firers assume a standing firing position with pistols in holsters. The leaders conduct ALT-C training using three stationary engagements from three different firing positions at 25 meters using a B1 target. Leaders fire the task in Pistol, ALT-C from the ready for each engagement. Table D-75 provides the firing positions for each engagement.

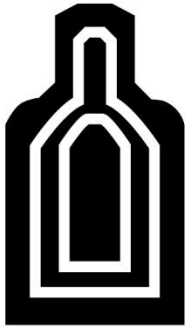
Table D-75. Firing position by engagement

| <i>Engagement</i> | <i>Position / Drill</i> | <i>Time (seconds)</i> | <i>DODIC</i> | <i>Magazine</i> | <i>Rounds per Magazine</i> |
|--|-------------------------|-----------------------|--------------|-----------------|----------------------------|
| 1 | Standing | 35 | AC20 | 1 | 10 |
| | <i>Emergency reload</i> | 10 | | | |
| | <i>Fight down</i> | | | | |
| 2 | Kneeling | 35 | AC20 | 1 | 10 |
| | <i>Emergency reload</i> | 10 | | | |
| | <i>Fight down</i> | | | | |
| 3 | Prone | 35 | AC20 | 1 | 10 |
| Total Time: | | 125 | | | |
| Legend: DODIC – Department of Defense identification code | | | | | |

D-114. Soldiers begin ALT-C training by moving into the firing position with the use of administrative commands from the tower operator. Administrative commands control the flow of the range, movement of personnel, and other command and control purposes. Table D-76, on page D-68, provides an example of the tower commands for moving a new firing order into position.

Table D-76. Alternate Course of Fire, new firing order, conduct of the range example

| <i>New Firing Order, Conduct of the Range</i> | | | |
|---|---|-----------------------|-----------------------|
| | Engagement | Target | Target Type |
| | New Firing Order | N/A | N/A |
| | Rounds per Target | DODIC | Time (Seconds) |
| | N/A | AC20 | NO LIMIT |
| TOWER | | SOLDIER ACTION | |
| CONDUCT OF THE RANGE | <p>FIRERS,</p> <p>HOLSTER YOUR WEAPON</p> <p>SECURE YOUR AMMUNITION</p> <p>ONCE COMPLETE MOVE TO YOUR ASSIGNED FIRING POINT</p> | | |
| <p>Soldiers secure weapon in holster, ammunition in magazines, and move to the designated firing point.</p> | | | |
| TOWER WAITS FOR ALL SOLDIERS TO REACH FIRING POINT PRIOR TO CONTINUING. | | | |
| Legend: DODIC – Department of Defense identification code, m – meter, N/A – not applicable | | | |

D-115. As soon as the tower confirms all firers are at the appropriate firing point, the tower operator proceeds to the next step. ALT-C has three firing engagements. Table D-77 contains the commands for engagement 1. The amount of ammunition required to fire engagement 1 of ALT-C is one, 10-round magazine. (See tables D-78 and D-79, on pages D-70 and D-71.)

Table D-77. Alternate Course of Fire engagement 1, conduct of fire example

| Table VI, ALT-C, Engagement 1, Day, Standing, 1 Magazine (10-rounds) | | | |
|---|--|--|----------------|
| <p>25m LANE 1 BASELINE</p> | Engagement | Target | Target Type |
| | 1 | B1 | Point |
| | Rounds per Target | DODIC | Time (Seconds) |
| | 10 | AC20 | 45 |
| TOWER | | SOLDIER ACTION | |
| WEAPONS SAFETY STATUS RED | MAKE READY | Soldier draws pistol and loads one 10-round magazine, ensuring weapon is on SAFE, and remains at the READY. | |
| ALERT | CONTACT | | |
| TARGET DESCRIPTION | BRAVO ONE | | |
| DIRECTION | FRONT | | |
| RANGE | SHORT RANGE | | |
| METHOD | SLOW FIRE | | |
| CONTROL | WEAPONS FREE WEAPONS FREE | | |
| EXECUTION | ENGAGE UPON POSITIVE IDENTIFICATION | Soldier begins slow firing one 10-round magazine, ensuring the same point of aim for each round. If a malfunction occurs, firer clears the malfunction and continues until the engagement is complete. | |
| TOWER PROVIDES FIRERS 35 SECONDS TO COMPLETE TASK, THEN PROCEEDS | | | |
| CONTROL | WEAPONS HOLD WEAPONS HOLD RELOAD FIGHT DOWN | Note: WEAPONS HOLD is used to ensure firers do not continue to engage the static B1 target until they reload and assume the next firing position. Firers conduct an emergency or tactical reload and move to the kneeling position. | |
| TOWER PROVIDES 10 SECONDS TO RELOAD AND CHANGE POSITION, THEN PROCEEDS | | | |
| WEAPONS SAFETY STATUS REMAINS RED | | | |
| Legend: ALT-C – alternate course of fire, DODIC – Department of Defense identification code, m – meter | | | |

Table D-78. Alternate Course of Fire, engagement 2, conduct of fire example

| Table VI, ALT-C, Engagement 2, Day, Kneeling, 1 Magazine (10-rounds) | | | |
|---|--|---|-----------------------|
| | Engagement | Target | Target Type |
| | 2 | B1 | Point |
| | Rounds per Target | DODIC | Time (Seconds) |
| | 10 | AC20 | 45 |
| TOWER | | SOLDIER ACTION | |
| WEAPONS SAFETY STATUS REMAINS RED | | | |
| ALERT | CONTACT | Soldiers ensure weapon is on SAFE and remain at the READY. | |
| TARGET DESCRIPTION | BRAVO ONE | | |
| DIRECTION | FRONT | | |
| RANGE | SHORT RANGE | | |
| METHOD | SLOW FIRE | | |
| CONTROL | WEAPONS FREE WEAPONS FREE | | |
| EXECUTION | ENGAGE UPON POSITIVE IDENTIFICATION | Soldier begins slow firing one 10-round magazine, ensuring the same point of aim for each round. If a malfunction occurs, firer clears the malfunction and continues until the engagement is complete. | |
| TOWER PROVIDES FIRERS 35 SECONDS TO COMPLETE TASK, THEN PROCEEDS | | | |
| CONTROL | WEAPONS HOLD WEAPONS HOLD | Soldiers conduct an emergency or tactical RELOAD and move to the prone position. | |
| | RELOAD | Note: WEAPONS HOLD is used to ensure firers do not continue to engage the static B1 target until they reload and assume the next firing position. Firers conduct an emergency or tactical reload and move to the prone position. | |
| | FIGHT DOWN | | |
| TOWER WAITS 10 SECONDS FOR RELOAD AND CHANGE OF POSITION, THEN PROCEEDS | | | |
| WEAPONS SAFETY STATUS REMAINS RED | | | |
| Legend: ALT-C – alternate course of fire, DODIC – Department of Defense identification code, m – meter | | | |

Table D-79. Alternate Course of Fire, engagement 3, conduct of fire example

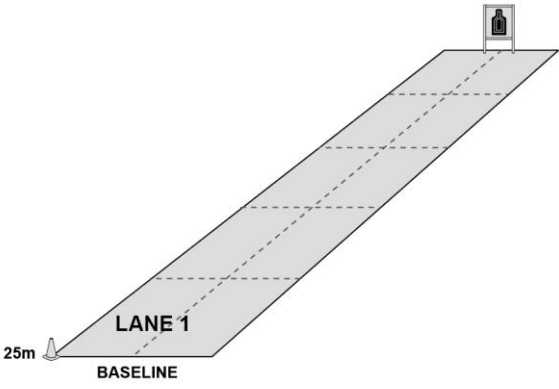
| <i>Table VI, ALT-C, Engagement 3, Day, Prone, 1 Magazine (10-rounds)</i> | | | |
|---|-------------------------------------|--|-----------------------|
|  | Engagement | Target | Target Type |
| | 3 | B1 | Point |
| | Rounds per Target | DODIC | Time (Seconds) |
| | 10 | AC20 | 35 |
| TOWER | | SOLDIER ACTION | |
| WEAPONS SAFETY STATUS REMAINS RED | | | |
| ALERT | CONTACT | Soldiers ensure weapon is on SAFE and remain at the READY. | |
| TARGET DESCRIPTION | BRAVO ONE | | |
| DIRECTION | FRONT | | |
| RANGE | SHORT RANGE | | |
| METHOD | SLOW FIRE | | |
| CONTROL | WEAPONS FREE WEAPONS FREE | | |
| EXECUTION | ENGAGE UPON POSITIVE IDENTIFICATION | Soldier begins slow firing one 10-round magazine, ensuring the same point of aim for each round. If a malfunction occurs, firer clears the malfunction and continues until the engagement is complete. | |
| TOWER AWAITS 35 SECONDS AND THEN PROCEEDS | | | |
| WEAPONS SAFETY STATUS REMAINS RED | | | |
| Legend: ALT-C – alternate course of fire, DODIC – Department of Defense identification code, m – meter | | | |

D-116. Once the firing order is complete, the tower operator directs the firers to a green WSS, and directs policing their firing positions of brass and ammunition. Table D-80 is an example of this command.

Table D-80. Alternate Course of Fire, completed firing order, conduct of the range example

| <i>Completed Firing Order, Conduct of the Range</i> | | | |
|--|---|--|-----------------------|
| FIRING ORDER COMPLETE | Engagement | Target | Target Type |
| | Completed Firing Order | N/A | N/A |
| | Rounds per Target | DODIC | Time (Seconds) |
| | N/A | N/A | NO LIMIT |
| TOWER | SOLDIER ACTION | | |
| WEAPONS SAFETY STATUS IS CURRENTLY RED | | | |
| TERMINATION | CEASE FIRE CEASE FIRE | Soldier stops firing and places the weapon on SAFE. | |
| WEAPONS SAFETY STATUS GREEN | GO GREEN GO GREEN SHOW CLEAR | Soldiers clear their weapon and wait for a lane safety to verify. | |
| ONCE VERIFIED HOLSTER | | | |
| CONDUCT OF THE RANGE | FIRERS SECURE YOUR TARGET AND DUNNAGE ONCE COMPLETE MOVE TO THE ENTRY CONTROL POINT AT THE BASE OF THE TOWER. | Firers secure their target and ammunition dunnage and move to the designated location. | |
| ONCE FIRING ORDER EXITS TO THE ENTRY CONTROL POINT, TOWER MOVES THE NEXT FIRING ORDER TO THE FIRING BASELINE. | | | |
| Legend: DODIC – Department of Defense identification code, N/A – not applicable | | | |

D-117. A lane safety clears the firers upon their completion of ALT-C training and collecting their dunnage. A lane safety verifies the clearing prior to the Soldier moving from their firing point. Once cleared, the lane safety communicates the WSS to the tower operator who issues an administrative command moving the completed Soldiers off the range.

Appendix E

Rifle and Carbine

This appendix describes the Army-standard events for training through qualification of all Soldiers assigned the M16 rifle or M4 carbine. Once this training is successfully completed, Soldiers can progress to higher levels of marksmanship training or certification, and may use the weapon during any collective live-fire training events within the qualification period.

This appendix is an overview of the qualification standards. This appendix is divided into sections, one for each training event within the weapon’s strategy, as well as CBRN, night requirements, and an authorized alternative course of fire. Commanders can use this appendix as a snapshot of the Army’s requirement to achieve and sustain a level of weapons proficiency for their Soldiers who have a rifle and carbine assigned to them. Soldiers assigned multiple weapons and executing the rifle and carbine training strategy must also be qualified on their primary assigned individual weapon and equipment within the past qualification period based on the commanders MAL.

RIFLE AND CARBINE TRAINING STRATEGY

E-1. The standard IWTS format of six tables describes the training events. Each table explains the events with all associated resources required; ranges, simulators, simulations, ammunition, and time, as appropriate. Companies executing the training events apply the eight-step training model, as appropriate.

E-2. Table E-1 shows the rifle and carbine training strategy through qualification. The table information explains the sequence of training events, the days required, and the training time remaining to achieve live-fire proficiency.

Table E-1. Individual weapons training strategy structure

| <i>Rifle and Carbine</i> | <i>Table I, PMI&E</i> | <i>Table II, PLFS</i> | <i>Table III, Drills</i> | <i>Table IV, Basic</i> | <i>Table V, Practice</i> | <i>Table VI, QUAL</i> |
|---|---------------------------|-----------------------|--------------------------|------------------------|--------------------------|-----------------------|
| | | <i>Night</i> | | | | <i>Day</i> |
| | | <i>CBRN</i> | | | | <i>Night*</i> |
| | | | | | | <i>CBRN*</i> |
| | PRQ | PRQ | PRQ | REQUIRED | | REQUIRED |
| Days Required | 0.5 | 0.5 | 0.5 | 1.0 | 1.0 | 1.0 |
| <p>Legend: CBRN – chemical, biological, radiological, and nuclear, PLFS – preliminary live-fire simulation, PMI&E – preliminary marksmanship instruction and evaluation, PRQ – prerequisite, QUAL – qualification *Conducted live-fire when simulator not available</p> | | | | | | |

E-3. Table E-2 illustrates the ammunition required for the rifle and carbine training strategy through qualification. The table includes the associated weapons by LIN and NSN, all training munitions including DDI requirements, and the live-fire training ammunition requirements.

E-4. The numbers displaced in the table replicate how much ammunition each firer is authorized to complete one iteration of each event within the training strategy through qualification. The munitions listed below do not include retraining, cross-training and demonstration munitions, or collective training requirements.

E-5. Training ammunition is not resourced to units with access to an approved simulator system for those tasks. Units with access to approved systems complete the night and CBRN qualification requirements in the authorized system only. Units without access to an approved simulator system conduct the night fire and CBRN qualifications under live-fire conditions at the completion of Table VI, Qualification training (see stage 2, stage 3, and stage 4).

Table E-2. Rifle and carbine individual weapon training strategy ammunition requirements

| <i>DODIC</i> | <i>Munition Type</i> | <i>Table III, DRILLS</i> | <i>Table IV, BASIC</i> | <i>Table V, PRACTICE</i> | <i>Stage 1 Table VI, QUAL</i> | <i>Total</i> |
|---|---|------------------------------|---------------------------------------|-------------------------------|---|--------------|
| AB57 | CTG, 5.56mm, ball, M855A1 EPR | | 45 | 40 | 40 | 125 |
| AB46 | CTG, 5.56mm, single round, DDI, M199A1 | | | 1 | | 1 |
| <i>Additional Requirements for Stage 2, 3, and 4 are authorized only when approved Simulation Systems are NOT Available</i> | | | | | | |
| <i>DODIC</i> | <i>Munition Type</i> | | <i>Stage 2 Day Fire, CBRN</i> | <i>Stage 3 Night Fire</i> | <i>Stage 4 Night Fire, CBRN</i> | <i>Total</i> |
| AB57 | CTG, 5.56mm, ball, M855A1 EPR | | 10 | 10 | 5 | 25 |
| AB74 | CTG, 5.56mm, tracer, M856A1, EPR | | | 10 | 5 | 15 |
| AB46 | CTG, 5.56mm single round, DDI, M199A1 | | 0 | 0 | 0 | 0 |
| <i>Model</i> | <i>LIN / NSN</i> | | <i>Model</i> | <i>LIN / NSN</i> | | |
| M4 | R97234 / 1005-01-231-0973 | | M16A2 | R95035 / 1005-01-128-9936 | | |
| M4A1 | C06935 / 1005-01-382-0953 | | M16A4 | R97175 / 1005-01-383-2872 | | |
| Note. Units are not resourced training ammunition for Table VI, Qualification, CBRN, or Table VI, Qualification, Night, when an authorized simulator system is provided as part of the basis of issue plan. | | | | | | |
| Legend: CBRN – chemical, biological, radiological, and nuclear, CTG – cartridge, DDI – dummy, drilled, inert; DODIC – Department of Defense identification code, EPR – enhanced performance round, LIN – line item number, mm – millimeter, NSN – national stock number, QUAL – qualification course of fire | | | | | | |

RIFLE AND CARBINE, TABLE I, PMI&E

E-6. The PMI&E event is a live-fire prerequisite that Soldiers must complete prior to executing any live-fire event for the rifle and carbine. Rifle and Carbine, Table I, PMI&E training consists of tasks that are critical to the safety of the firer, essential to the operation of the weapon assigned, or key to the effective employment of the weapon system. Leaders use Rifle and Carbine, Table I to test the Soldier's ability to accomplish these critical tasks correctly, effectively, and efficiently. Units conduct all tasks in a garrison environment prior to the live-fire weapons training density.

TASK, CONDITIONS, AND STANDARD

E-7. Units are encouraged to conduct preparatory training prior to Table I training (for example, hip pocket training, sergeant’s time training) to maximize available resources. Units will develop a written test evaluating the functional aspects of the weapon, ammunition, and critical skills articulated in TC 3-22.9. Soldiers must successfully complete Rifle and Carbine, Table I, PMI&E tasks within the training window T-6 through T-week for both active Army and Reserves. (See table E-3.)

Note. Refer to TC 3-20.0 for more information on the training timelines for all live-fire prerequisites. Weapon specific and tactical employment information regarding rifle and carbine is in TC 3-22.9.

E-8. At a minimum, Soldiers assigned an M4- or M16-series weapon are provided instruction and evaluation on the standard PMI&E topics described in TC 3-22.9. Units may add topics to their Table I, requirements, as necessary.

Table E-3. Rifle and Carbine, Table I, Preliminary Marksmanship Instruction and Evaluation

| | |
|--|---|
| Task: | Demonstrate proficiency on the functional aspects of the weapon, ammunition, and critical skills necessary to correctly and safely employ the rifle and carbine. |
| Conditions: | In a garrison environment, given a rifle or carbine as assigned on the master authorization list for the unit. Provided the correct reference to conduct training: <ul style="list-style-type: none"> • TC 3-22.9. • TM 9-1005-319-10. |
| Standard: | The Soldier must successfully pass PMI&E between T-6 And T-week prior to firing any live ammunition by receiving all GOs on demonstrated performance and achieving a passing score of 80 percent or higher on a written test. |
| Legend: PMI&E – preliminary marksmanship instruction and evaluation, TC – training circular, TM – training manual | |

E-9. Table E-4 shows the training event design template for Rifle and Carbine, Table I, PMI&E. Units use the training event design templates to assist in the proper synchronization when developing their UTP.

Table E-4. Training event design template for Rifle and Carbine, Table I

| Rifle and Carbine, Table I, PMI&E | | | | | | |
|--|-----------------|---------------------------|-------------------------|---------------------------------------|--------------------------|---------------------------------|
| EVENT NAME: | PMI&E | ENVIRONMENT: | | LIVE | 0.5 | |
| WEAPON: | M4 / M16 | CONDITIONS: | | HANDS ON | | |
| CATEGORY: | FOUNDATION | PRIMARY FACILITY: | | GARRISON | DAYS REQUIRED | |
| PUBLICATION: | TC 3-22.9 | ALTERNATE FACILITY: | | CLASS | | |
| REQUIRED: | YES | COMPONENT: | AC | RC | 120 SOLDIERS | |
| EXTERNAL EVAL: | OPTIONAL | FREQUENCY: | 2 | 1 | | |
| VALID FOR: | T+6 | ANNUAL DAYS TOTAL: | 1 | 0.5 | THROUGHPUT | |
| TABLE | | | | | | |
| | I | II | III | IV | V | VI |
| | PMI&E | PLFS | DRILLS | BASIC | PRACTICE | QUAL |
| | REQUIRED | | | | | 4.0 |
| WHEN EXECUTED: | T-6 through T-X | | | | | TNG DAYS TO QUAL |
| CONDEMNATION CRITERIA (CC) | RULE 1 | RULE 2 | RULE 3 | RULE 4 | RULE 5 | RULE 6 |
| | TIME | KEY LEADER TURNOVER | COMMANDER ASSESSMENT | SUBORDINATE ELEMENT PROFICIENCY | SPECIALTY PROFICIENCY | STAFF SECTION PROFICIENCY |
| Remarks: Each Soldier assigned an individual weapon must successfully complete Table I, PMI&E, between T-6 and T-X, <i>prior to any live-fire event with the weapon.</i> | | | | | | |
| Note: Table I <i>should</i> be completed prior to any other table to ensure the Soldier understands the proper functioning and immediate action for the weapon. | | | | | | |
| Legend: AC – active component (known as Active Duty), CLASS - classroom, EVAL – evaluation, PLFS – preliminary live-fire simulation, PMI&E – preliminary marksmanship instruction and evaluation, QUAL – qualification, RC – Reserve Component (known as Reserves), T+6 – training week or month plus six, TC – training circular, T-X – training event exercise, TNG DAYS TO QUAL – number of training days remaining on the critical path to weapon's qualification | | | | | | |

TRAINING PLAN

E-10. Table E-5, on page E-6, shows the Rifle and Carbine, Table I, PMI&E training plan's tasks. Soldiers must demonstrate proficiency on these tasks to receive credit. Leaders and trainers must be proficient on these tasks prior to conducting training and testing.

Table E-5. Rifle and Carbine, Table I, Preliminary Marksmanship Instruction and Evaluation training plan

| Reference | Topic or Task |
|--|--|
| TC 3-22.9 | Ammunition identification |
| TC 3-22.9 | Rules of fire arms safety |
| TC 3-22.9 | Weapons safety status |
| TC 3-22.9 | Weapons control status |
| TC 3-22.9 | Cycle of function, rifle and carbine |
| TC 3-20.31-4 | Conduct of fire (fire commands) |
| TC 3-22.9 | Magazine change, rifle and carbine, emergency |
| TC 3-22.9 | Magazine change, rifle and carbine, tactical |
| TC 3-22.9 | Preliminary marksmanship instruction and evaluation (PMI&E), rifle and carbine |
| 071-COM-0032 | Maintain an M16-series rifle / M4-series rifle carbine |
| 071-COM-0029 | Perform a function check on an M16-series rifle / M4-series carbine |
| 071-705-0011 | Mount the M68 close combat optic (CCO) on a M16-series rifle or M4-series carbine |
| 071-705-0005 | Mount the M150 rifle combat optic (RCO) on a M16-series rifle or M4-series carbine |
| 071-705-0015 | Boresight a backup iron sights (BUIS) on a M16A4 rifle or M4-series carbine |
| 071-705-0013 | Boresight the M68 close combat optic (CCO) on a M16-series rifle or M4-series carbine |
| 071-705-0007 | Boresight the M150 rifle combat optic (RCO) on a M16-series rifle or M4-series carbine |
| 071-COM-0031 | Zero an M16-series rifle / M4-series carbine |
| 071-705-0003 | Zero an M68 sight (close combat optic) to a M16-series rifle / M4-series carbine |
| 071-705-0008 | Zero the M150 rifle combat optic (RCO) on a M16-series rifle or M4-series carbine |
| Note: ALL Soldiers assigned a rifle and carbine will conduct PMI&E. Soldiers will conduct maintain and functions check tasks only for the weapon they are assigned. | |
| Legend: COM – common, TC – training circular | |

RIFLE AND CARBINE, TABLE II, PRELIMINARY LIVE-FIRE SIMULATIONS

E-11. The tasks in Table II, PLFS evaluate the Soldier's ability to engage single and multiple stationary targets from multiple stationary supported and unsupported firing positions, during day and limited visibility, and during CBRN conditions in a simulated combat environment. Soldiers are required to complete the simulations training plan prior to executing the Table II simulated qualification course of fire. Table II (see table E-6) is a live-fire prerequisite that Soldiers complete prior to any event using live ammunition (for example, Tables IV, V, and VI).

TASK, CONDITIONS, AND STANDARD

E-12. Units must use the approved primary or alternate simulations to execute Table II tasks for record between T-6 and T-week for the upcoming weapons training density. Units must maintain the Soldiers' training records for 12 months. When conducting live-fire events, units must have the Soldier's Table II training records readily available on the range facility.

Table E-6. Rifle and Carbine, Table II, Preliminary Live-Fire Simulations

| | |
|--------------------|--|
| Task: | Demonstrate proficiency on the functional aspects of the weapon, ammunition, and critical skills necessary to correctly use the M16 rifle or M4 carbine with associated equipment. |
| Conditions: | Given the following: <ul style="list-style-type: none"> • Fully mission capable weapon and equipment as assigned on the master authorization list for the unit. • Full combat uniform, issued equipment, and protective mask (if assigned). • An authorized simulations device with standard training model and rifle or carbine, Table II, Gate to Live Fire (GTLF) event. |
| Standard: | Demonstrate proficiency on select rifle and carbine tasks and successfully complete the GTLF event between T-6 and T-week prior to firing any live ammunition. |

E-13. Table E-7 shows the general training information for planning purposes for the rifle and carbine, Table II. The training event design template provides key training information to develop the UTP for their Soldiers.

Table E-7. Training event design template for rifle and carbine, Table II, Preliminary-Live-Fire Simulations

| <i>Rifle and Carbine, Table II, PLFS</i> | | | | | | |
|--|------------------|---------------------------|-------------------------|---------------------------------------|--------------------------|---------------------------------|
| EVENT NAME: | PLFS | ENVIRONMENT: | | VIRTUAL | 0.5 | |
| WEAPON: | M4 / M16 | CONDITIONS: | | TADSS | | |
| CATEGORY: | FOUNDATION | PRIMARY FACILITY: | | S / SVT | DAYS REQUIRED | |
| PUBLICATION: | TC 3-22.9 | ALTERNATE FACILITY: | | EST | | |
| REQUIRED: | YES | COMPONENT: | AC | RC | 120 SOLDIERS | |
| EXTERNAL EVAL: | OPTIONAL | FREQUENCY: | 2 | 1 | | |
| VALID FOR: | T+6 | ANNUAL DAYS TOTAL: | 1 | 0.5 | THROUGHPUT | |
| | TABLE | | | | | |
| | I | II | III | IV | V | VI |
| | PMI&E | PLFS | DRILLS | BASIC | PRACTICE | QUAL |
| | | REQUIRED | | | | 3.5 |
| WHEN EXECUTED: | T-6 through T-X | | | | | TNG DAYS TO QUAL |
| CONDEMNATION CRITERIA (CC) | RULE 1 | RULE 2 | RULE 3 | RULE 4 | RULE 5 | RULE 6 |
| | TIME | KEY LEADER TURNOVER | COMMANDER ASSESSMENT | SUBORDINATE ELEMENT PROFICIENCY | SPECIALTY PROFICIENCY | STAFF SECTION PROFICIENCY |
| Remarks: Each Soldier assigned an individual weapon must successfully complete Table II, PLFS, between T-6 and T-X, prior to any live-fire event with the weapon. | | | | | | |
| Legend: AC – active component (known as active duty), EST – engagement skills trainer, EVAL – evaluation, PLFS – preliminary live-fire simulation, PMI&E – preliminary marksmanship instruction and evaluation, QUAL – qualification, RC – Reserve Component (known as Reserves), S / SVT – soldier and squad virtual trainer, TADSS – training aids, devices, simulators, and simulations, TC – training circular, T+6 – training week or month plus six, T-X – training event exercise, TNG DAYS TO QUAL – number of training days remaining on the critical path to weapon’s qualification | | | | | | |

SIMULATIONS

E-14. Each Soldier is authorized simulations usage for weapons training and sustainment based on their component. The authorized hours of training are cumulative annually to enable completing all required training prior to the execution of Table II training. Table E-8 shows the annual hours authorized per Soldier by component:

Table E-8. Annual simulations authorizations table

| <i>Simulation Time Authorizations (hours)</i> | |
|---|-----------------|
| <i>Active Army</i> | <i>Reserves</i> |
| 12.0 | 6.0 |

E-15. Table E-9 shows the primary and alternate simulations systems. Primary systems are the preferred method to deliver the appropriate training program to the Soldier. Alternate systems provide the minimum form, fit, and function capabilities to build the firer's skill and experience on basic tasks. The unit determines how to use the simulations hours authorized per Soldier within the fiscal year.

Table E-9. Rifle and Carbine, Table II, Primary and alternate authorized systems

| <i>System</i> | <i>Primary</i> | <i>Alternate</i> | <i>Remarks</i> |
|---|----------------|------------------|---|
| Soldier and Squad Virtual Trainer (S / SVT) | X | | |
| Engagement skills trainer | | X | Serves as a primary training device until S / SVT suite availability and accessibility are established Army-wide. |
| Dry-fire engagement drills | | X | Least preferred method. Commanders should review dry-fire drill tasks and effectiveness prior to authorizing use. |

Note. For any other device or system not listed, the unit should contact the Maneuver Center of Excellence for possible system evaluation or to inquire if an approved training plan is available. Units are not authorized to develop training plans on systems not specifically authorized when authorized systems are available for training.

Individual weapons virtual simulation systems can support no more than five firers per suite at a time. The standard simulations bay is composed of two suites, allowing ten firers to train in a firing order. The unit should develop a rotational plan to accommodate the number of Soldiers training.

TRAINING PLAN

E-16. Soldiers train on their weapon within the simulation system's training plan. For simulation systems without an integrated training plan, operators must select the appropriate scenarios based on the system's IUH.

E-17. The simulations rifle and carbine training plan culminates in the system's GTLF. Units may elect to train additional, advanced tactical engagement scenarios but must conduct grouping practice, CBRN, night fire, and the GTLF exercises at a minimum, as listed in table E-10, on page E-10.

Table E-10. Rifle and carbine simulations training plan

| Aiming Device | Task | Exercise Name | Required GTLF |
|---|-------------|--------------------------------|----------------------|
| Iron Sights | 1 | Grouping and Zeroing | REQ |
| | 2 | Confirmation and Hold-Offs | REQ |
| | 3 | Table V, Practice | REQ |
| | 4 | Table VI, Qualification | GTLF |
| | 5 | CBRN Fire | REQ |
| | 6 | Night Fire | REQ |
| Optics | 7 | Grouping and Zeroing | REQ |
| | 8 | Confirmation and Hold-Offs | REQ |
| | 9 | Table V, Practice | REQ |
| | 10 | Table VI, Qualification | GTLF |
| | 11 | CBRN Fire | REQ |
| | 12 | Night Fire | REQ |
| Legend: CBRN – chemical, biological, radiological, and nuclear, GTLF – gate to live fire, REQ – required | | | |

RIFLE AND CARBINE, TABLE III, DRILLS

E-18. Table III, Drills, is a series of physical actions (drills) that a Soldier completes with their assigned weapon and equipment in a repetitious manner to demonstrate proficiency in weapons handling and movement. Soldiers must complete the tasks in this table prior to any live-fire event including grouping procedures.

TASK, CONDITIONS, AND STANDARD

E-19. Typically, units conduct, Table III training in a round-robin manner where the primary trainer is the team leader, squad leader, or assigned NCO. Table III's task, conditions, and standards are shown in table E-11.

Table E-11. Rifle and Carbine, Table III, Drills, task, conditions, and standard

| | |
|--------------------|--|
| Task: | Demonstrate proficiency on the functional aspects of the weapon, ammunition, and critical skills necessary to correctly use the M16 rifle or M4 carbine with associated assigned equipment. |
| Conditions: | Given the following: <ul style="list-style-type: none"> Fully mission capable, weapon and equipment as assigned on the master authorization list for the unit. Checklist of required actions and time standards found in Training Circular 3-22.9 and associated individual task report described in this section. |
| Standard: | The Soldier successfully demonstrates proficiency by passing weapons handling, manipulation, and movement tasks listed in the training plan between T-6 and T-week prior to firing any live ammunition. |

E-20. Table E-12 shows the general training information for planning purposes for Rifle and Carbine, Table III. The training event design template provides key training information so planners can develop the UTP for their Soldiers.

Table E-12. Training event design template for rifle and carbine, Table III, Drills

| Rifle and Carbine, Table III, Drills | | | | | | | | | | | |
|---|------------------------|---------------------------|-------------------------|---------------------------------------|--------------------------|---------------------------------|--|----------|--|---------------------|--|
| EVENT NAME: | DRILLS | ENVIRONMENT: | | LIVE | 0.5 | | | | | | |
| WEAPON: | M4 / M16 | CONDITIONS: | | HANDS ON | | | | | | | |
| CATEGORY: | FOUNDATION | PRIMARY FACILITY: | | GARRISON | DAYS REQUIRED | | | | | | |
| PUBLICATION: | TC 3-22.9 | ALTERNATE FACILITY: | | TA | | | | | | | |
| REQUIRED: | YES | COMPONENT: | AC | RC | 120 SOLDIERS | | | | | | |
| EXTERNAL EVAL: | FIRST LINE LEADER | FREQUENCY: | 2 | 1 | | | | | | | |
| VALID FOR: | T+6 | ANNUAL DAYS TOTAL: | 1 | 0.5 | THROUGHPUT | | | | | | |
| TABLE | | | | | | | | | | | |
| I | | II | | III | | IV | | V | | VI | |
| PMI&E | | PLFS | | DRILLS | | BASIC | | PRACTICE | | QUAL | |
| | | | | REQUIRED | | | | | | 3.0 | |
| WHEN EXECUTED: | T-6 through T-X or T-X | | | | | | | | | TNG DAYS TO QUAL | |
| CONDEMNATION CRITERIA (CC) | RULE 1 | RULE 2 | RULE 3 | RULE 4 | RULE 5 | RULE 6 | | | | | |
| | TIME | KEY LEADER TURNOVER | COMMANDER ASSESSMENT | SUBORDINATE ELEMENT PROFICIENCY | SPECIALTY PROFICIENCY | STAFF SECTION PROFICIENCY | | | | | |
| <p>Remarks: Each Soldier assigned an individual weapon must successfully complete Table III, between T-6 and T-X, prior to any live-fire event with the weapon. Table III should be used as concurrent training on Tables IV, V, and VI while Soldiers are awaiting training in a firing order or between day and night phases.</p> <p>Legend: AC active component (known as active duty), EVAL – evaluation, PLFS – preliminary live-fire simulation, PMI&E – preliminary marksmanship instruction and evaluation, QUAL – qualification, RC – Reserve Component (known as Reserves), T+6 – training week or month plus six, TA – training area, TC – training circular, T-X – training event exercise, TNG DAYS TO QUAL – number of training days remaining on the critical path to weapon's qualification</p> | | | | | | | | | | | |

TRAINING PLAN

E-21. Table E-13, on page E-12, lists the individual tasks for each of the rifle and carbine Table III drills. The individual task reports for the drills are in a shared folder on AKO. The hyperlink to this folder is in the reference section at the back of this publication.

Table E-13. Rifle and carbine, Table III, Drills individual training plan

| Task | Task Name |
|--|--|
| 1 | Precombat checks |
| 2 | Load and conduct status check |
| 3 | Carry positions |
| 4 | Fight down |
| 5 | Fight up |
| 6 | Go to prone |
| 7* | Transition from primary weapon to secondary weapon |
| 8 | Reload |
| 9 | Clear malfunction |
| 10 | Unload / show clear |
| <p>Note. Where the individual task reports are not available on the Army Training Network, the individual task reports for these drills are in a shared folder on Army Knowledge Online. The hyperlink to this folder is in the reference section at the back of this publication.</p> <p>* This drill is only for Soldiers assigned multiple individual weapons or Soldiers assigned an individual weapon with a special purpose weapon.</p> | |

E-22. Units may add to the drills listed in table E-13, but may not remove any from Table III. Units developing additional drills are encouraged to provide the details of the drill, evaluation process, and timing considerations to the proponent of this publication for possible inclusion into future updates.

RIFLE AND CARBINE, TABLE IV, BASIC

E-23. Units conduct drills listed in Rifle and Carbine, Table IV, Basic with live ammunition on an approved range facility. Table IV is for all firers to evaluate their ability to consistently place shot groups within a designated bullseye target at 25 meters. Units conduct this table only after successful completion of the live-fire prerequisite tables (Tables I, II, and III). During home station training, Soldiers must complete Table IV tasks prior to progressing to any other training event. Units conduct Table IV tasks on an automated record fire range (known as ARF) or other approved facility.

TASK, CONDITIONS, AND STANDARD

E-24. Firers conduct Table IV tasks from the prone supported firing position 25 meters from the targets outlined in this chapter. Table IV tasks reinforce and build upon the skills Soldiers learned in the previous training events. Units conduct Table IV training in four stages: Stage 1, Grouping; Stage 2, Zeroing; Stage 3, Confirmation at True Distance; and Stage 4, Application of Hold-Offs. Table E-14 provides the task, conditions, and standards for Table IV.

Table E-14. Rifle and carbine, Table IV, Basic

| | |
|--------------------|---|
| Task: | Conduct grouping, zeroing, confirmation of zero at distance, and slow fire engagement procedures proficiency with the M4- or M16-series weapon with the primary optic. |
| Conditions: | Given the following: <ul style="list-style-type: none"> • Fully mission capable weapon, magazine pouches, and magazines. • Authorized range facility, full-caliber ammunition, and approved targetry. • Unit selected method of zeroing (as described in Training Circular 3-22.9). |
| Standard: | <p>Grouping – Successfully group by placing four of five rounds in two consecutive five-round shot groups within a 6 minute of angle (MOA) circle (threshold) or 4 MOA (objective) at 25-meters.</p> <p>Zeroing – Successfully place four of five rounds in two consecutive shot groups within the 6 MOA circle (threshold) or 4 MOA (objective) surrounding the appropriate point of impact on the A8 zero target at 25-meters.</p> <p>Confirmation at Distance – After completion of the 25 meter zero, the Soldier must successfully hit a properly presented E-type target with a minimum of four of five (80-percent) shots.</p> <p>Application of Hold-Offs – After completion of confirmation at distance stage the Soldier must successfully hit a properly presented 100 meter E-type target with a minimum of four of five (80-percent) shots then the Soldier must also successfully hit a properly presented 200 meter E-type target with a minimum of four of five (80-percent) shots.</p> |

E-25. Table E-15, on page E-14, shows the training event design template for the Table IV, Basic. Units conduct this event on an authorized live-fire facility, typically an ARF range. See TC 25-8 for additional information on authorized range facilities.

Table E-15. Training event design template for rifle and carbine, Table IV, Basic

| <i>Rifle and Carbine, Table IV, Basic</i> | | | | | | | | | | |
|--|------------|---------------------|---------------------|----------------------|--------|---------------------------------|----------|-----------------------|--|---------------------------|
| EVENT NAME: | BASIC | | ENVIRONMENT: | LIVE | | 1.0 | | | | |
| WEAPON: | M4 / M16 | | CONDITIONS: | LIVE FIRE | | | | | | |
| CATEGORY: | FOUNDATION | | PRIMARY FACILITY: | ARF | | DAYS REQUIRED | | | | |
| PUBLICATION: | TC 3-22.9 | | ALTERNATE FACILITY: | MRF | | | | | | |
| REQUIRED: | YES | | COMPONENT: | AC | RC | 120 SOLDIERS | | | | |
| EXTERNAL EVAL: | COACH | | FREQUENCY: | 2 | 1 | | | | | |
| VALID FOR: | T-X | | ANNUAL DAYS TOTAL: | 2 | 1 | THROUGHPUT | | | | |
| TABLE | | | | | | | | | | |
| | I | | II | | III | | IV | V | | VI |
| | PMI&E | | PLFS | | DRILLS | | BASIC | PRACTICE | | QUAL |
| | PRQ | | PRQ | | PRQ | | REQUIRED | | | 2.0 |
| WHEN EXECUTED: | | | | | | | T-X | | | TNG DAYS TO QUAL |
| CONDEMNATION CRITERIA (CC) | RULE 1 | RULE 2 | | RULE 3 | | RULE 4 | | RULE 5 | | RULE 6 |
| | TIME | KEY LEADER TURNOVER | | COMMANDER ASSESSMENT | | SUBORDINATE ELEMENT PROFICIENCY | | SPECIALTY PROFICIENCY | | STAFF SECTION PROFICIENCY |
| Remarks: Each Soldier assigned an individual weapon must successfully complete Table IV, Basic. | | | | | | | | | | |
| Legend: AC – active component (known as active duty), ARF – automated record fire range, EVAL – evaluation, MRF – modified record fire range or similar, PLFS – preliminary live-fire simulation, PMI&E – preliminary marksmanship instruction and evaluation, PRQ – prerequisite, QUAL – qualification, RC – Reserve Component (known as Reserves), TC – training circular, T-X – training event exercise, TNG DAYS TO QUAL – number of training days remaining on the critical path to weapon’s qualification | | | | | | | | | | |

AMMUNITION

E-26. All Soldiers assigned a rifle or carbine on a unit MAL must complete all four stages of Rifle and Carbine, Table IV prior to advancing to Table V or Table VI training. Units conduct the table tasks to demonstrate the Soldier’s ability to place well-aimed shots at or near the intended point of impact of a target consistently.

E-27. Firers conduct Table IV training based on their primary optic assigned. Firers, who are not assigned the M68, close combat optic (known as CCO) or the M150, rifle combat optic (known as RCO), complete the iron sight tasks only. Firers assigned the M68 or M150 must complete the backup iron sight (known as BUIS) and CCO or RCO grouping and zeroing. Firers with the backup iron sight and optic conduct confirmation at distance and application of hold-offs with the primary aiming device only. Table E-16 shows the optics, the line item number, and the associated national stock numbers that are authorized ammunition for the BUIS and primary optic.

Table E-16. Table IV, Basic, primary optics

| <i>Optic</i> | <i>LIN</i> | <i>NSN</i> | | |
|---|------------|------------------|------------------|------------------|
| BUIS | | 1005-01-484-8000 | | |
| M68, CCO | S60288 | 1240-01-411-1265 | 1240-01-540-3690 | 1240-01-576-6134 |
| M150, RCO | S45729 | 1240-01-557-1897 | | |
| <p>Note. All firers will complete grouping, zeroing, confirmation at distance, and application of hold-offs with primary aiming device.</p> <p>Only firers assigned the M68 CCO are authorized the second iteration of grouping and zeroing ammunition for their BUIS.</p> <p>On weapons assigned the M150, RCO, the BUIS must be removed for use to achieve the appropriate eye relief. No training ammunition is authorized for zeroing the BUIS on weapons assigned the M150.</p> | | | | |
| <p>Legend: BUIS – backup iron sight, CCO – close combat optic, LIN – line item number, NSN – national stock number, RCO – rifle combat optic</p> | | | | |

E-28. To effectively plan and forecast for sufficient training ammunition, the unit should refer to the ammunition requirements listed in table E-17, on page E-16. Units must identify the total number of firers and should plan for unscheduled firers and necessary retraining by increasing their forecasted training ammunition appropriately.

Table E-17. Table IV, Basic, ammunition authorizations

| Optic | Stages | DODIC | Nomenclature | Quantity | Remarks |
|---|----------------------------------|-------|-----------------------------|----------|---|
| Iron sight, CCO, or RCO as the primary optic | Stage 1 Grouping | AB57 | CTG 5.56mm ball, M855A1 EPR | 15 | Three each, five-round shot groups. |
| | Stage 2 Zeroing | AB57 | CTG 5.56mm ball, M855A1 EPR | 15 | Three each, five-round shot groups after grouping exercise complete. |
| | Stage 3 Confirmation at Distance | AB57 | CTG 5.56mm ball, M855A1 EPR | 5 | One each, five-round shot group. |
| | Stage 4 Application of Hold-Offs | AB57 | CTG 5.56mm ball, M855A1 EPR | 10 | One each, five-round shot group for 100 meter target and 200 meter target. |
| CCO BUIS* | Stage 1 Grouping | AB57 | CTG 5.56mm ball, M855A1 EPR | 15 | Three each, five-round shot groups. |
| | Stage 2 Zeroing | AB57 | CTG 5.56mm ball, M855A1 EPR | 15 | Three each, five-round shot groups after grouping exercise complete. |
| | Stage 3 Confirmation at Distance | AB57 | CTG 5.56mm ball, M855A1 EPR | 5 | One each, five-round shot group <i>only after successful zeroing the primary optic.</i> |
| | Stage 4 Application of Hold-Offs | AB57 | CTG 5.56mm ball, M855A1 EPR | 10 | One each, five-round shot group for 100 meter target and 200 meter target. |
| Note. | | | | | |
| * - All firers will complete grouping, zeroing, and confirmation at distance with their primary aiming device. Only firers assigned the M68 close combat optic (CCO) are authorized the second iteration of grouping and zeroing ammunition for the BUIS. | | | | | |
| Legend: BUIS – backup iron sight, CTG – cartridge, DODIC – Department of Defense identification code, EPR – enhanced performance round, mm – millimeter, RCO – rifle combat optic | | | | | |

E-29. The ammunition NCO with a supporting ammunition detail loads the magazines with both training ammunition, as shown in tables E-18 and E-19, for iron sight, BUIS, CCO, and RCO tasks.

Table E-18. Rifle and Carbine, Table IV, ammunition breakdown, iron sights / backup iron sight per firer

| <i>Magazine</i> | <i>Stages</i> | <i>AB57 5.56mm Ball</i> | <i>Total Rounds per Magazine</i> |
|---|---------------------------------|---------------------------------|--------------------------------------|
| 1 | Stage 1 Grouping | 5 each | 5 rounds |
| 2 | Stage 1 Grouping | 5 each | 5 rounds |
| 3 | Stage 1 Grouping | 5 each | 5 rounds |
| 4 | Stage 2 Zero | 5 each | 5 rounds |
| 5 | Stage 2 Zero | 5 each | 5 rounds |
| 6 | Stage 2 Zero | 5 each | 5 rounds |
| 7 | Stage 3 Confirmation | 5 each | 5 rounds |
| 8 | Stage 4 Application of Hold-off | 10 each | 10 rounds |
| Total: | | 45 rounds | 45 rounds |
| Note: When zero confirmation cannot be fired on the scheduled range facility, units should include that task with associated ammunition in their Table V, Practice event. The task is integrated in the Table V scenario, prior to the first Table V engagement. | | | |
| Legend: mm – millimeter | | | |

Table E-19. Rifle and Carbine, Table IV, ammunition breakdown, close combat optic / rifle combat optic per firer

| <i>Magazine</i> | <i>Stages</i> | <i>AB57 5.56mm Ball</i> | <i>Total Rounds per Magazine</i> |
|--------------------------------|---------------------------------|---------------------------------|--------------------------------------|
| 1 | Stage 1 Grouping | 5 each | 5 rounds |
| 2 | Stage 1 Grouping | 5 each | 5 rounds |
| 3 | Stage 1 Grouping | 5 each | 5 rounds |
| 4 | Stage 2 Zero | 5 each | 5 rounds |
| 5 | Stage 2 Zero | 5 each | 5 rounds |
| 6 | Stage 2 Zero | 5 each | 5 rounds |
| 7 | Stage 3 Confirmation | 5 each | 5 rounds |
| 8 | Stage 4 Application of Hold-off | 10 each | 10 rounds |
| Total: | | 45 rounds | 45 rounds |
| Legend: mm – millimeter | | | |

RANGE FACILITIES

E-30. Table E-20 shows the Army-standard range facilities designed to support rifle and carbine, Table IV, Basic training. Units reference their installation’s range operations SOP or local training regulation to identify the weapon specific range facilities on the supporting installation. Units use their RFMSS system for all scheduling.

Table E-20. Rifle and carbine, Table IV, Basic authorized range facilities and targetry

| <i>Table IV, Stages</i> | <i>Range Facility</i> | | | |
|---|-----------------------|------------|------------|-------------|
| | <i>ARF</i> | <i>MRF</i> | <i>QTR</i> | <i>Zero</i> |
| Stage 1 Grouping 25 meters | P | P | P | A |
| Stage 2 Zeroing 25 meters | | | | |
| Stage 3 Confirmation at Distance | P | P | P | N/A |
| Stage 4 Application of Hold-Offs | P | P | P | N/A |
| Legend: A – alternate facility, ARF – automated record fire range, MRF – modified record fire range or similar, N/A – not applicable, P – primary facility, QTR – qualification training range, Zero – basic 10 meter / 25 meter firing range (zero) | | | | |

TARGETRY

E-31. Table IV, Grouping and Zeroing requires a minimum of three targets per firer, placed on a target frame as shown on figure E-1. The targets are placed on a frame with backer board at the 25-meter line. This is a static target presentation and does not use the automated targets on the primary range facility. During the preparation phase, leaders should be familiar with the targetry used, the target frames and their proper emplacement, and the firing sequence of the engagements. Figure E-2, on page E-20, shows the primary targets and their proper positioning on the primary range facility.



| Table IV Stages | Targetry | |
|--|---|---|
| Stage 1, Grouping 25 meters | A8 target zero M4- / M16-series weapons 25-meters zero. Short range and pistol marksmanship target. |  |
| Stage 2, Zeroing 25 meters | | |
| Stage 3, Confirmation at distance and Stage 4, Application of Hold-offs | E-1, target, silhouette: plastic, polyethylene, kneeling |  |
| | D-1 Target, 3-dimensional: plastic, mannequin, kneeling |  |
| Legend: NSN – national stock number | | |

Figure E-1. Rifle and carbine, Table IV, target requirements example

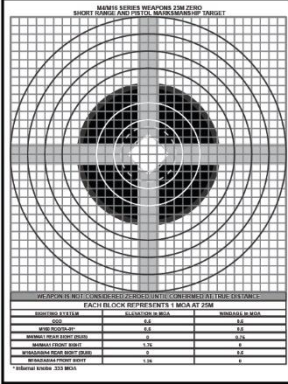
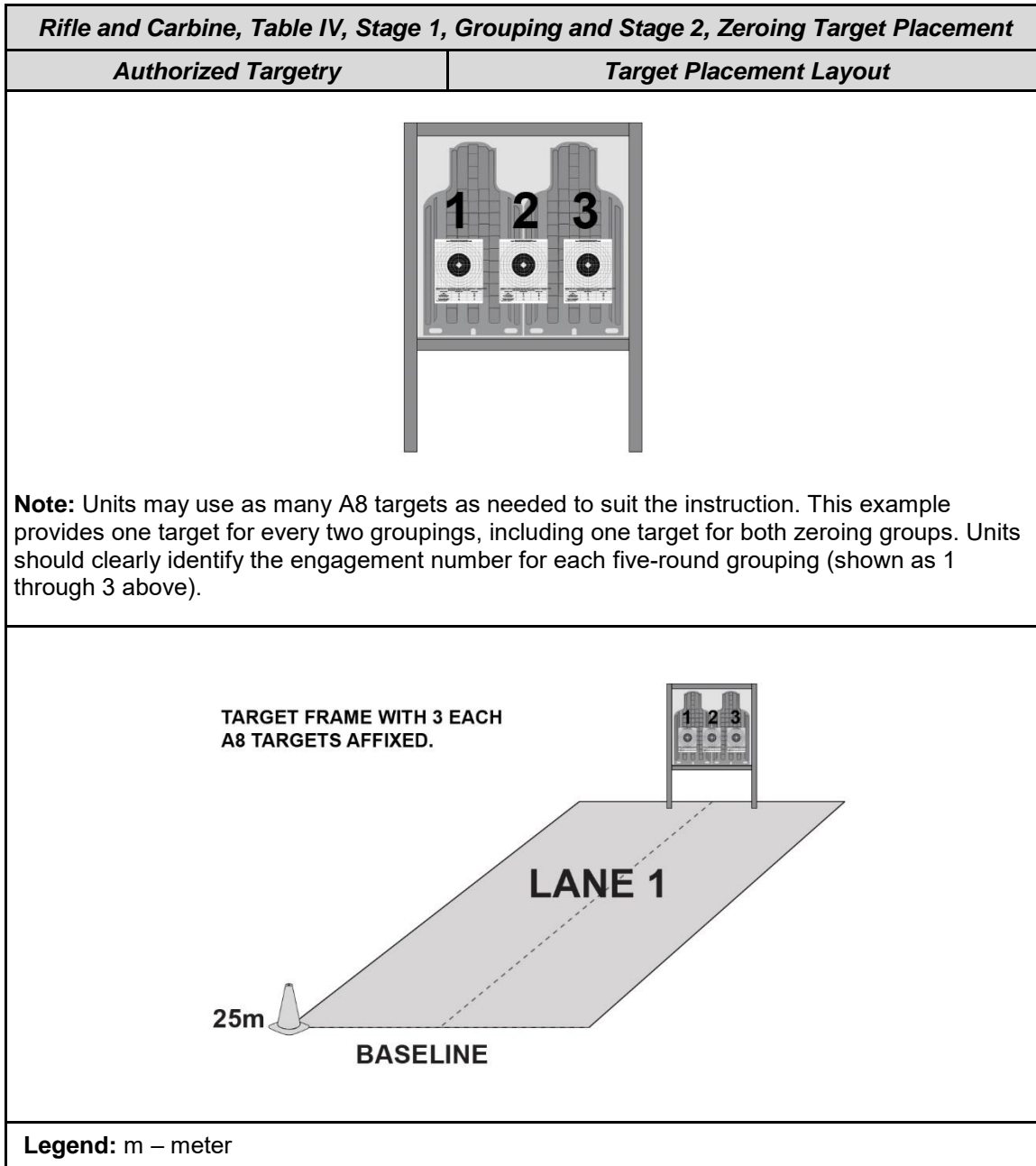

Figure E-2. Rifle and carbine, Table IV, stages 1 and 2, target requirements example

CONDUCT OF THE RANGE

E-32. Leaders teach Soldiers the objectives of grouping and the importance of the functional elements of the shot process (see TC 3-22.9). Units conduct Table IV training using eight separate engagements at targets that are 25 meters from the static firing point, with a zero confirmation target at distance (300-meter standard) and application of hold-offs at the 100 meter and 200-meter targets. Firers use one A8 target for two groupings. Soldiers complete the engagements in the sequence shown in table E-21. The A8 target is the only authorized zero target.

Table E-21. Rifle and carbine, Table IV, firing sequence example

| <i>Sequence / Magazine</i> | <i>AB57 5.56mm Ball</i> | <i>Target Frame</i> | <i>Target Type</i> |
|--------------------------------|-------------------------|-------------------------|--------------------|
| 1 Group 1 | 5 each | 1 | A8 |
| 2 Group 2 | 5 each | 1 | A8 |
| 3 Group 3 | 5 each | 2 | A8 |
| 4 Group 4 | 5 each | 2 | A8 |
| 5 Zero 1 | 5 each | 3 | A8 |
| 6 Zero 2 | 5 each | 3 | A8 |
| 7 Confirm at Distance | 5 each | 300 meter | E-type |
| 8 Application of Hold-Offs | 10 each | 100 meter and 200 meter | E-type |
| Legend: mm - millimeter | | | |

E-33. To complete Table IV training successfully, firers must meet the unit directed standard (threshold or objective) for their iron sight and BUIS and CCO and RCO when assigned. Table E-22, provides each threshold and objective standard for a shot group, grouping exercise, and zeroing. Once zeroing is complete, firers must conduct stages 3 and 4 to complete Table IV.

Table E-22. Shot group, grouping, and zeroing standards

| <i>Type</i> | <i>Standard</i> | | <i>Requirement</i> |
|--|------------------|------------------|--|
| | <i>Threshold</i> | <i>Objective</i> | |
| Shot group | 6 MOA | 4 MOA | Four of five rounds |
| Grouping | 6 MOA | 4 MOA | Two shot groups to standard |
| Begin zeroing | | | Grouping standard met |
| Zero | 6 MOA | 4 MOA | Standard shot group centered at the POA or applicable offset for optic being zeroed. |
| Legend: MOA – minute of angle, POA – point of aim | | | |

E-34. Figure E-3 through E-20, on pages E-23 through page E-40, provide the sequence of the engagements, with a basic example of the standards for a shot group, grouping, and zeroing procedure. This is a guide for the leader. See the appropriate TMs and TC 3-22.9 for detailed instructions.

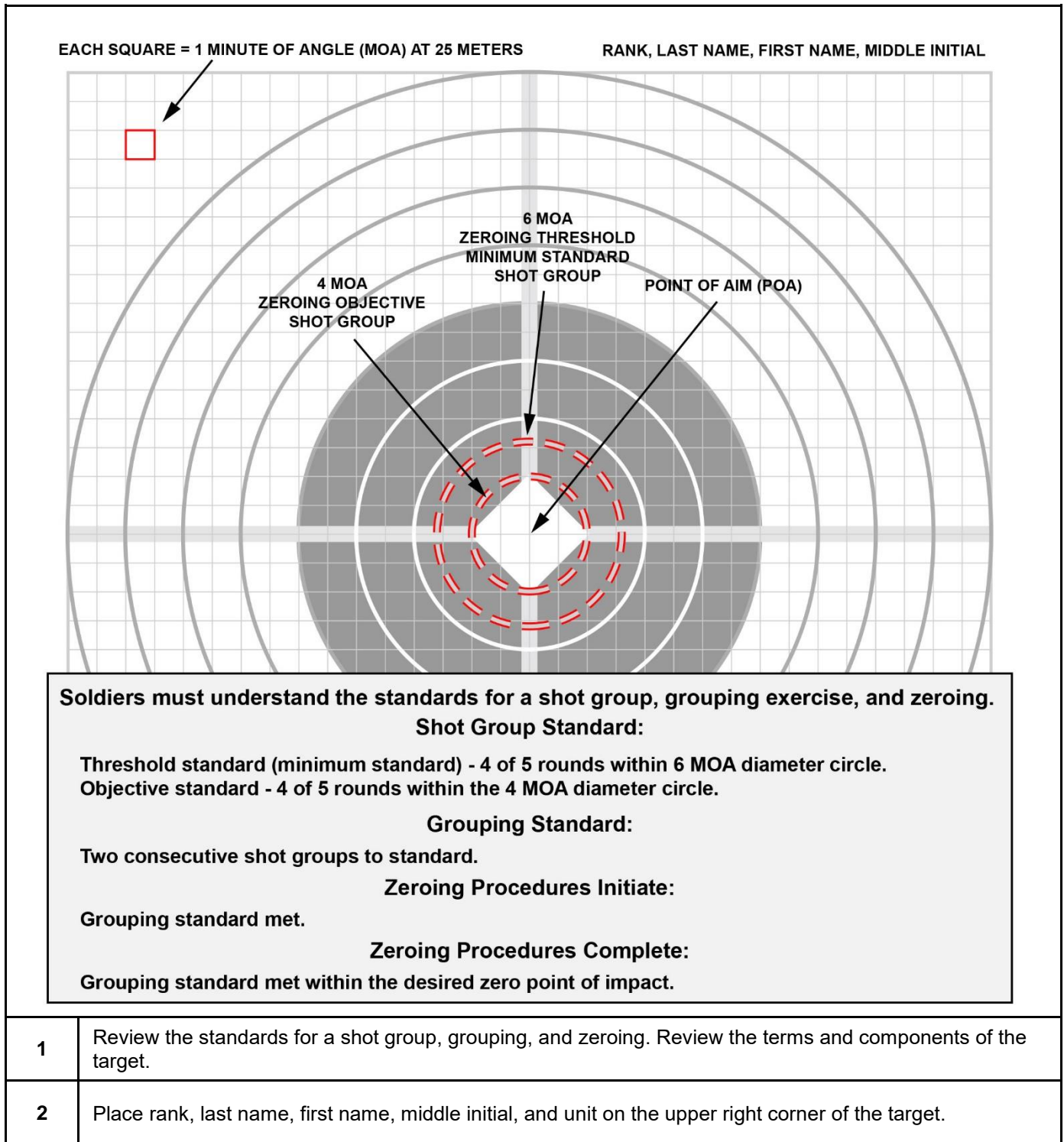

Figure E-3. Rifle and Carbine, Table IV, standards

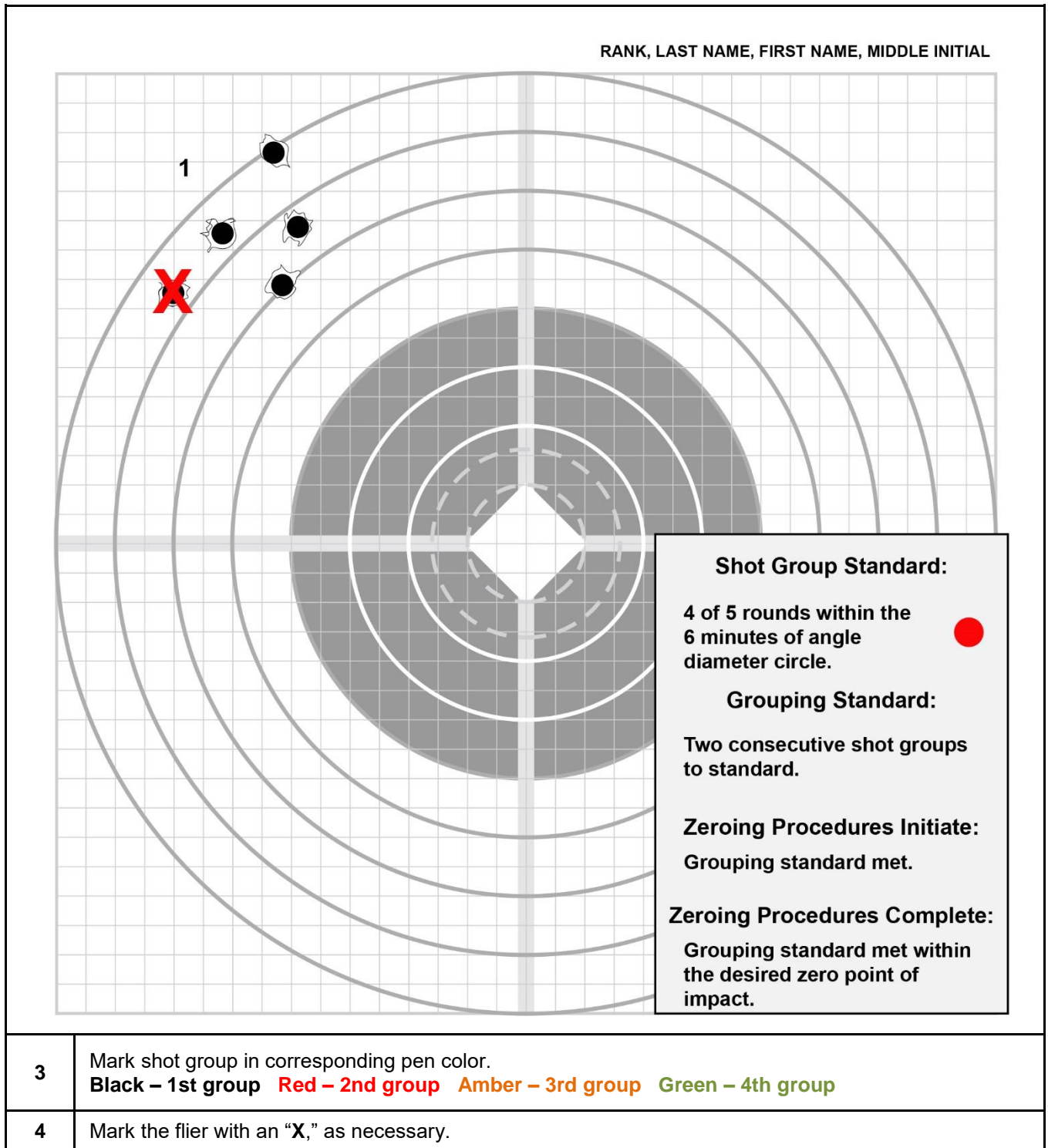

Figure E-4. Rifle and carbine group 1

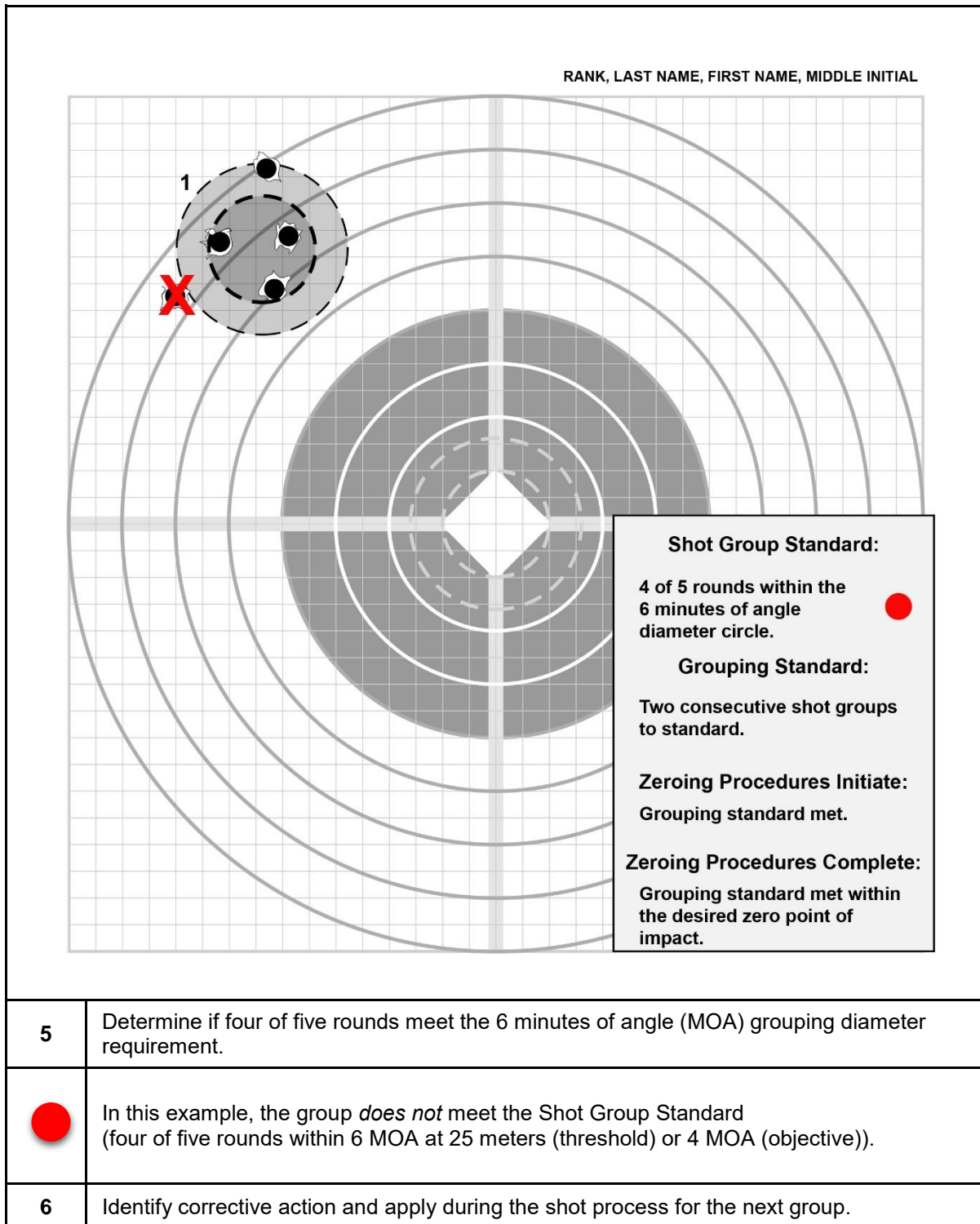

Figure E-5. Rifle and carbine group 1 grouping standard determination

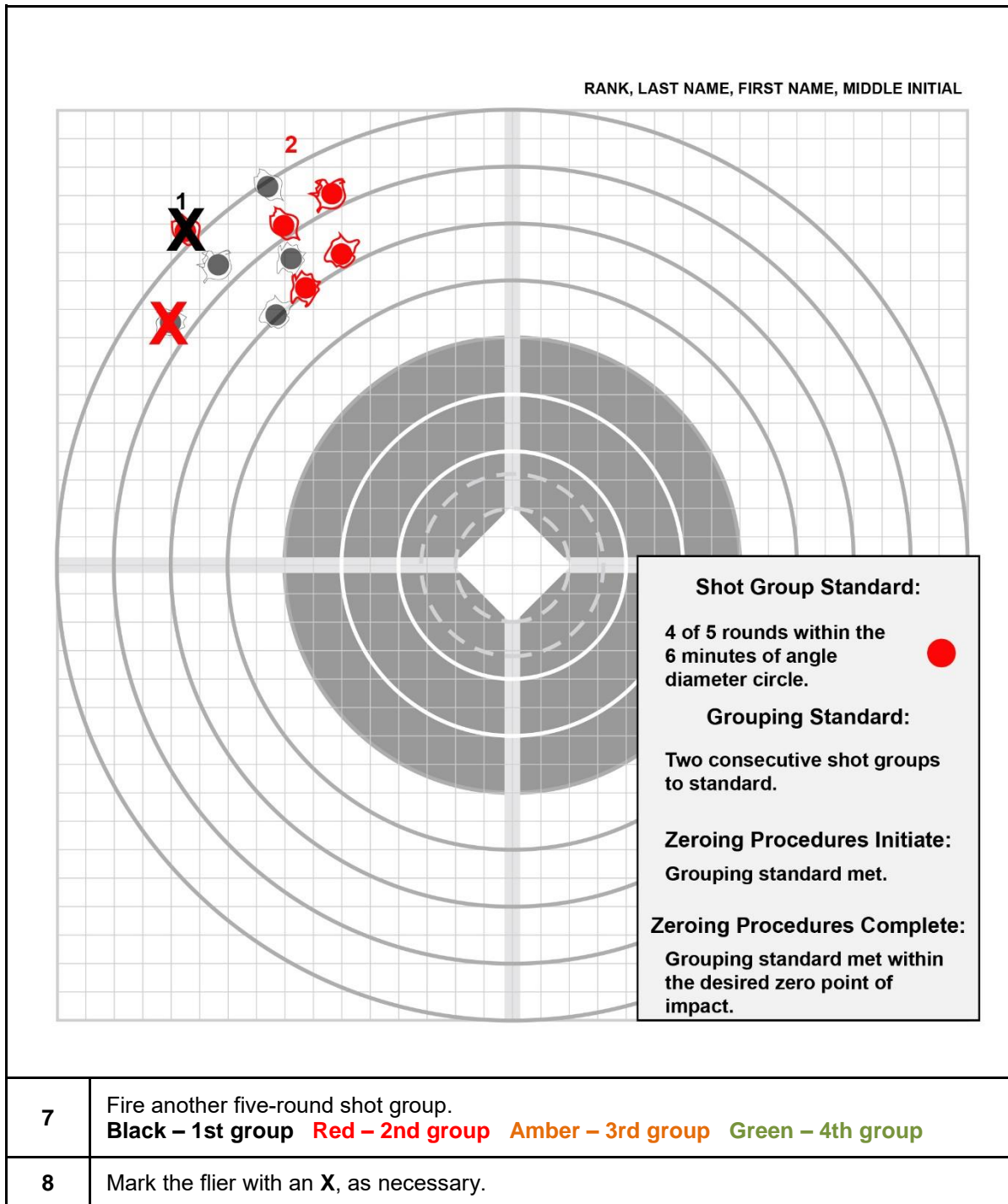

Figure E-6. Rifle and carbine group 2

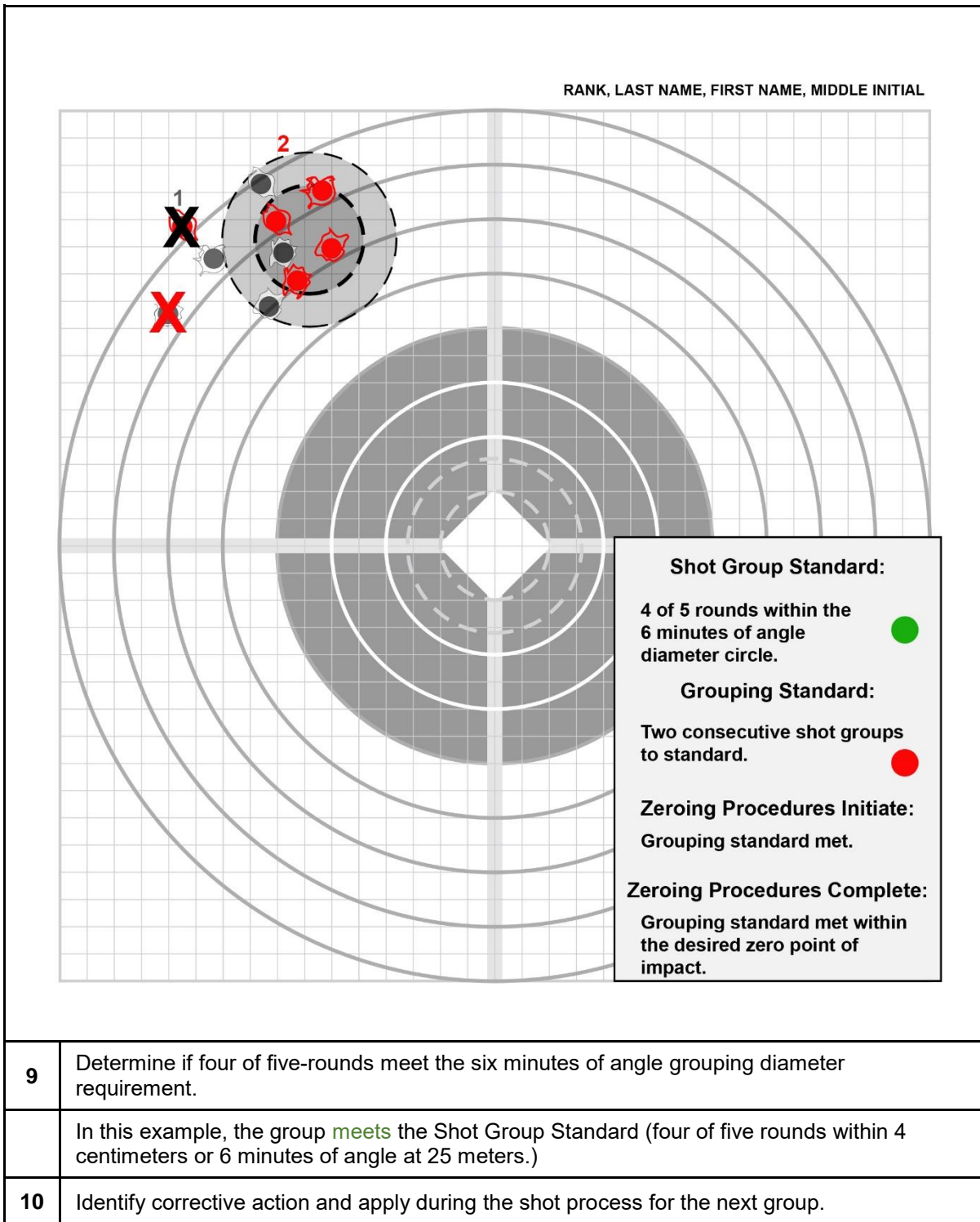

Figure E-7. Rifle and carbine group 2 standard determination

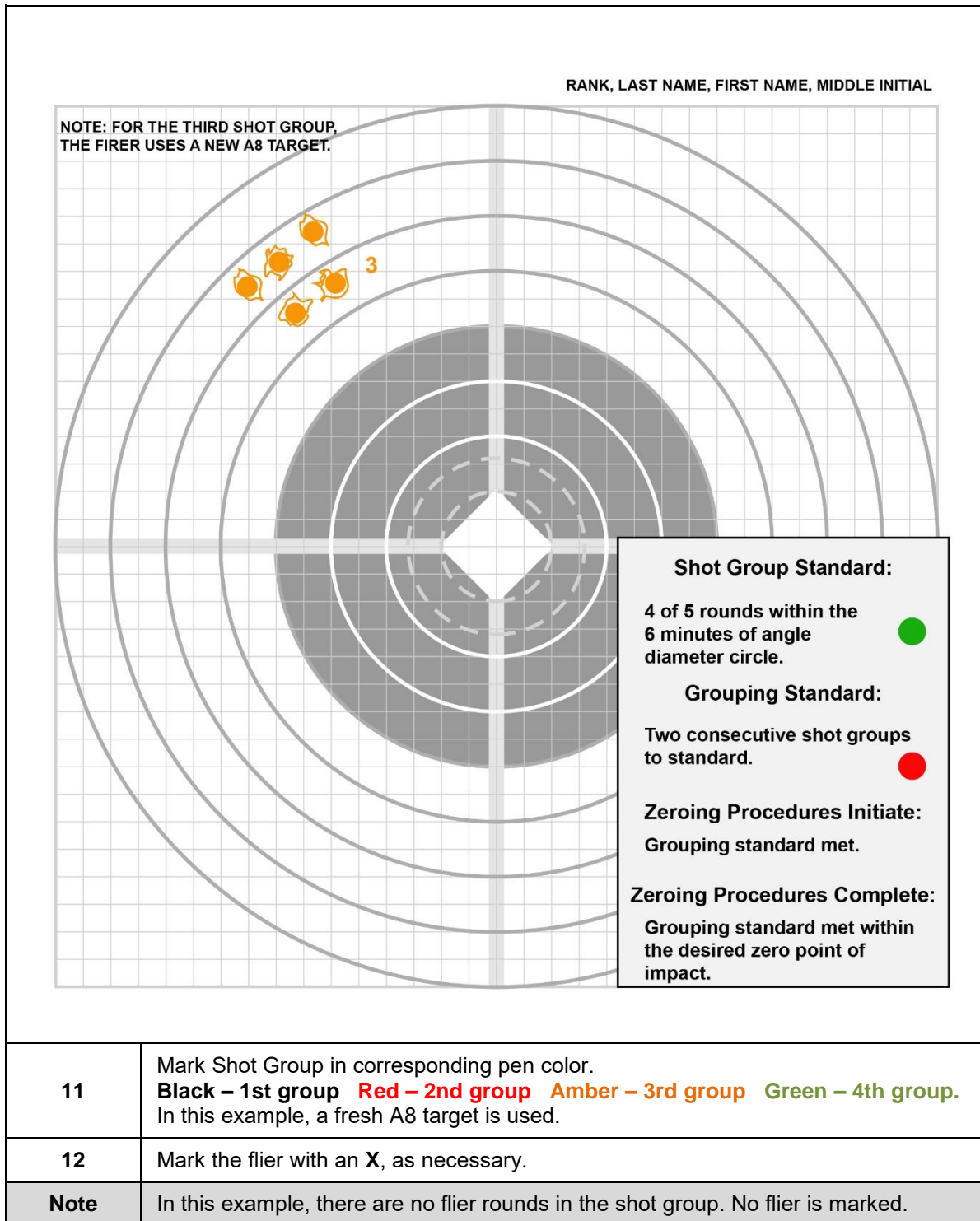

Figure E-8. Rifle and carbine group 3

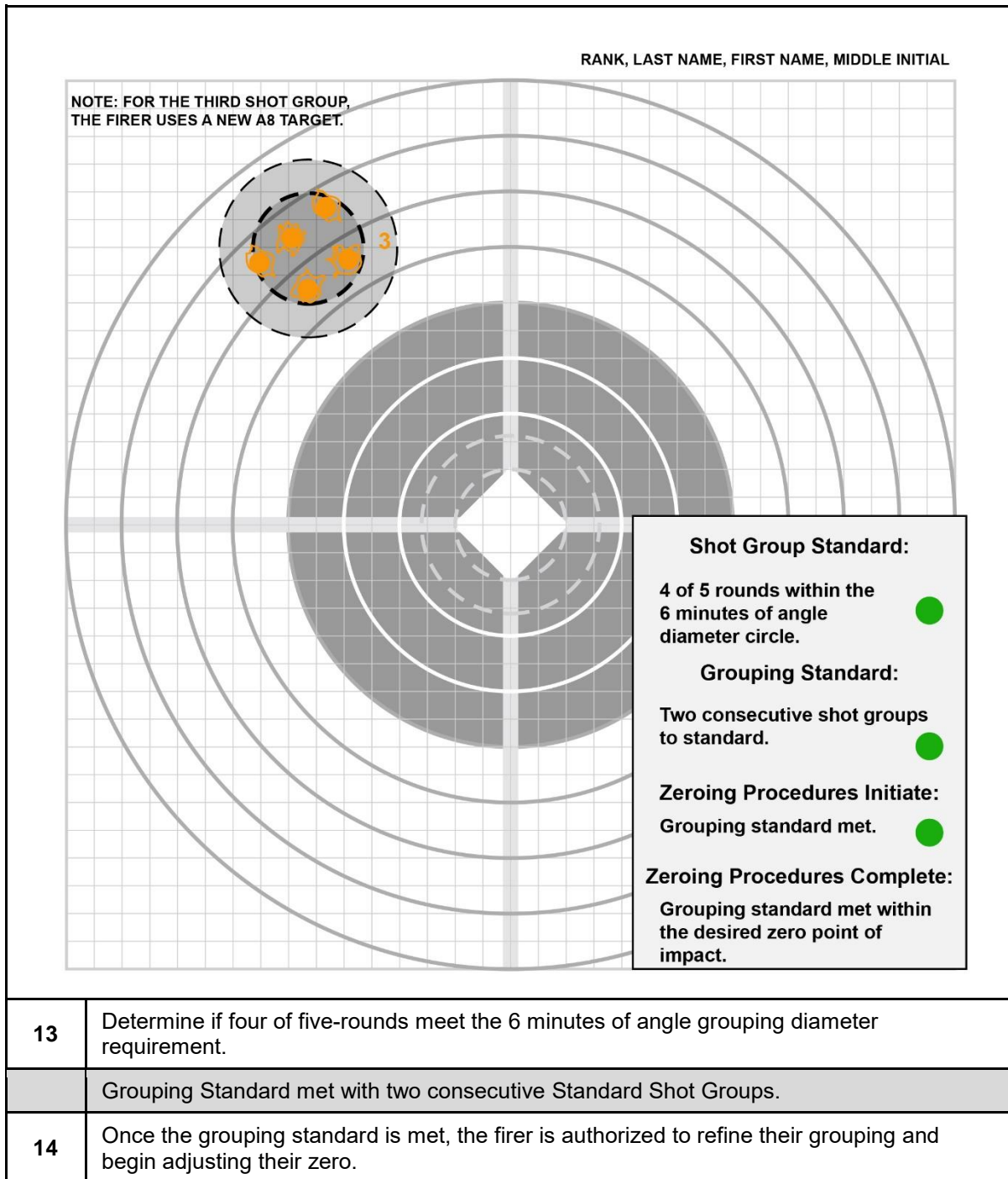

Figure E-9. Rifle and carbine group 3 grouping standard determination

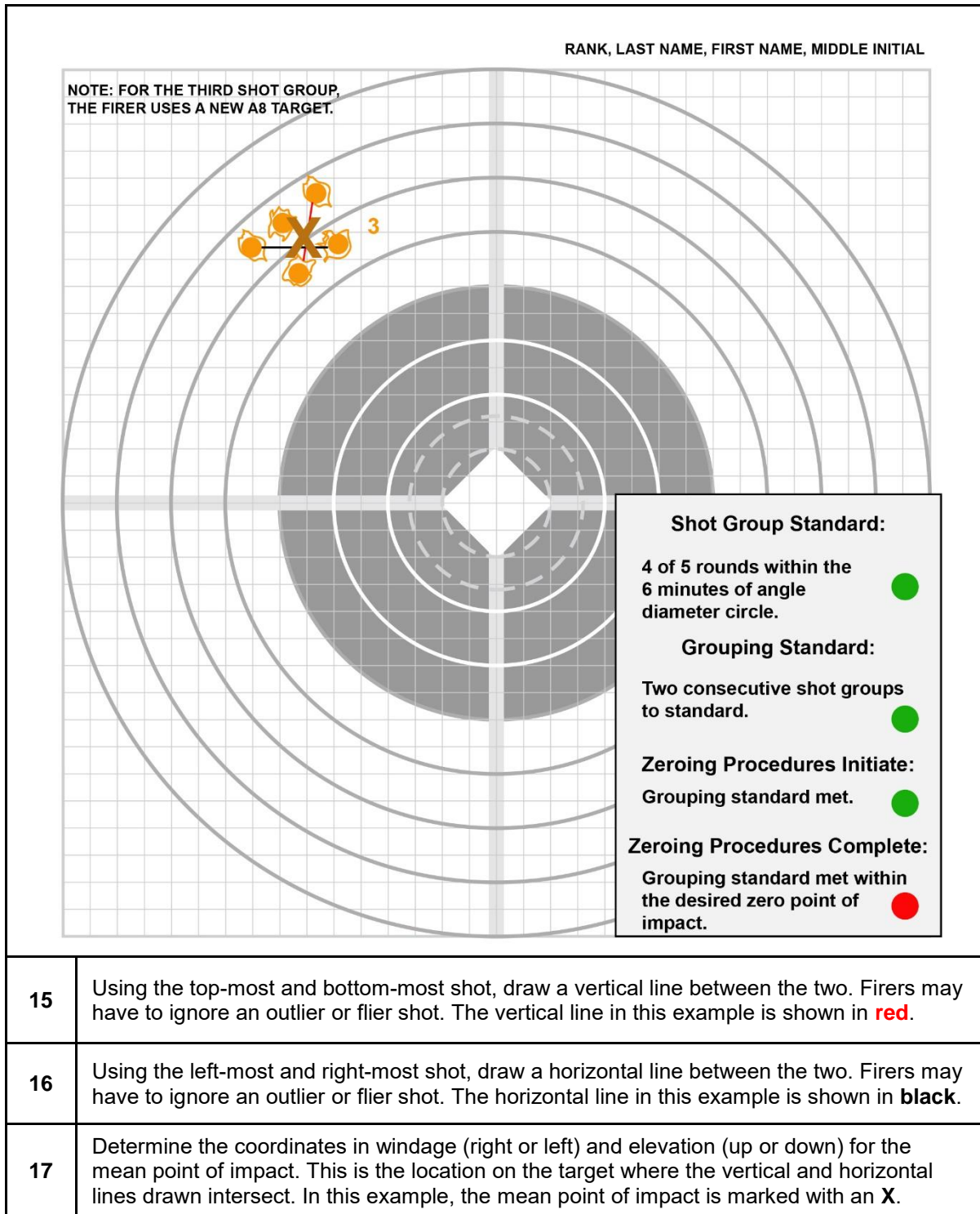

Figure E-10. Rifle and carbine group 3 mean point of impact determination

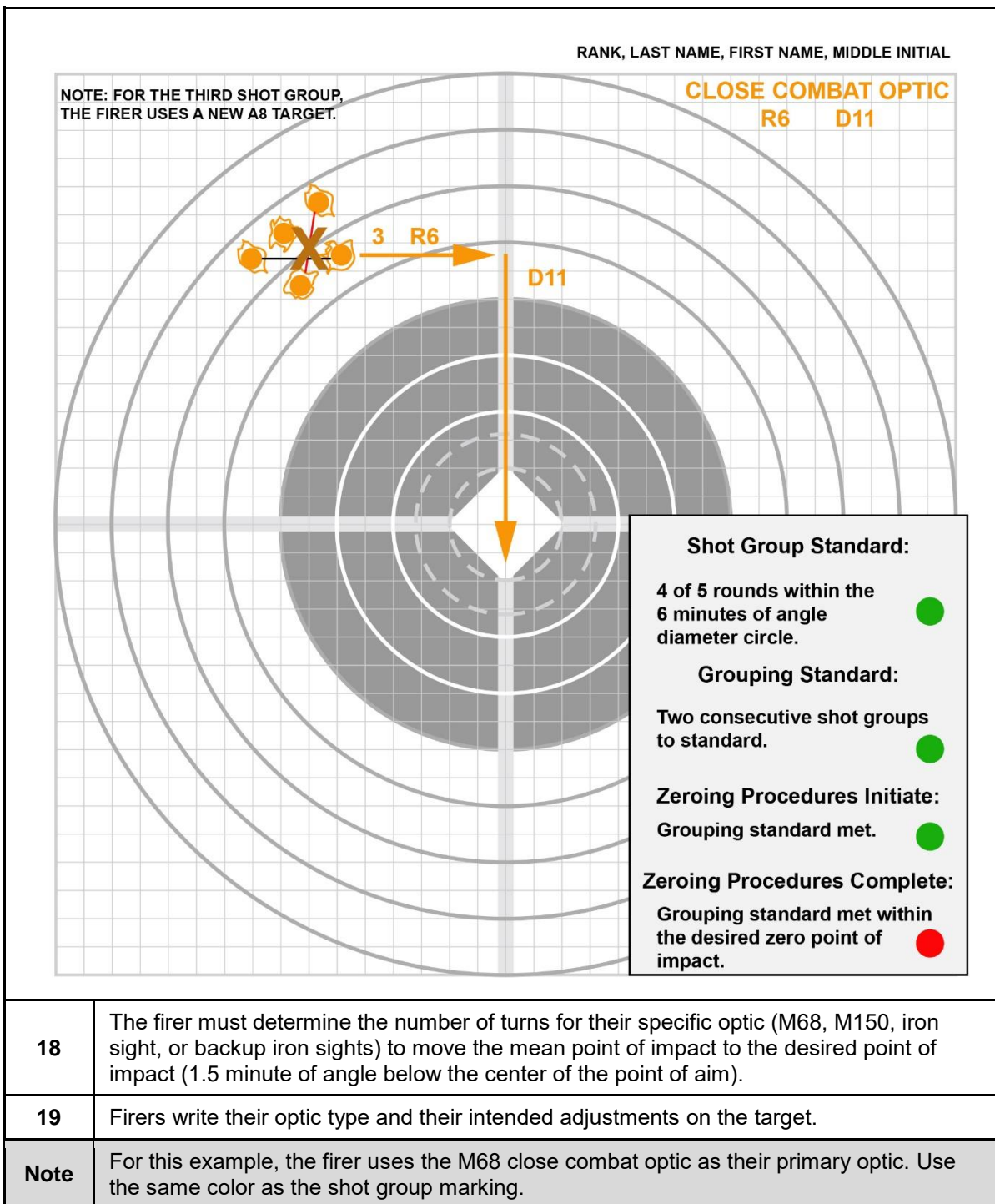

Figure E-11. Rifle and carbine mean point of impact adjustment determination

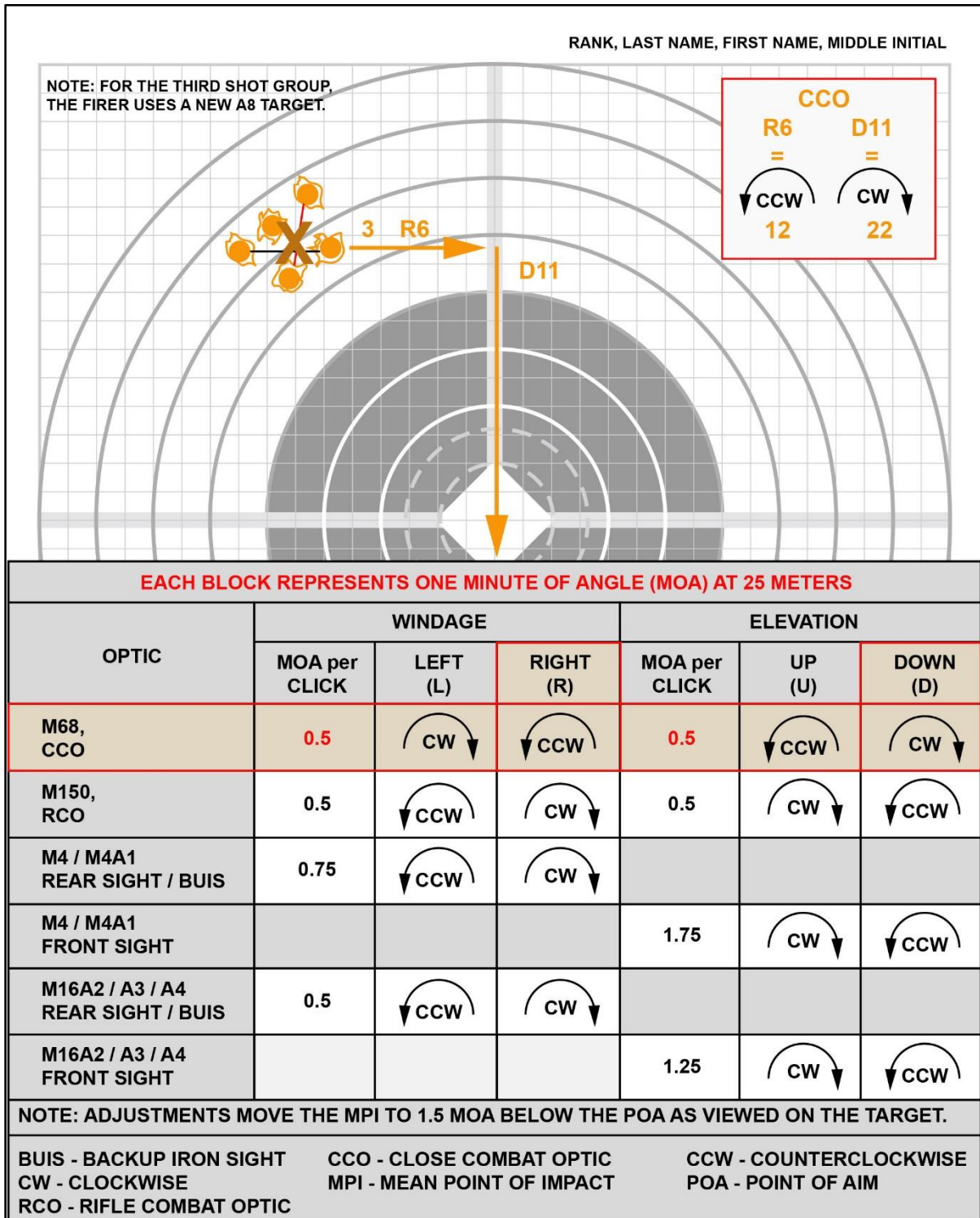

Figure E-12. Rifle and carbine mean point of impact adjustment

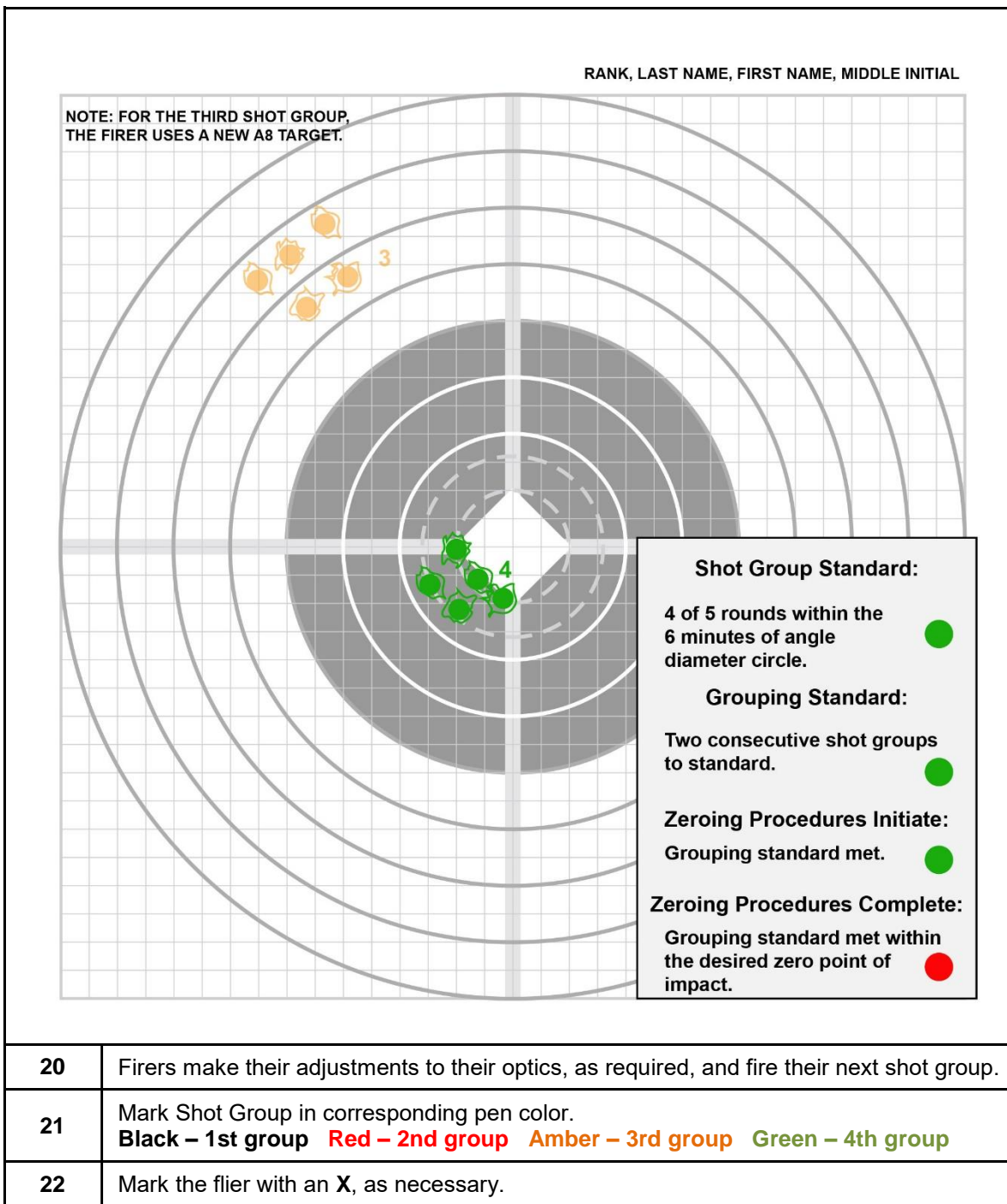

Figure E-13. Rifle and carbine zero group 1

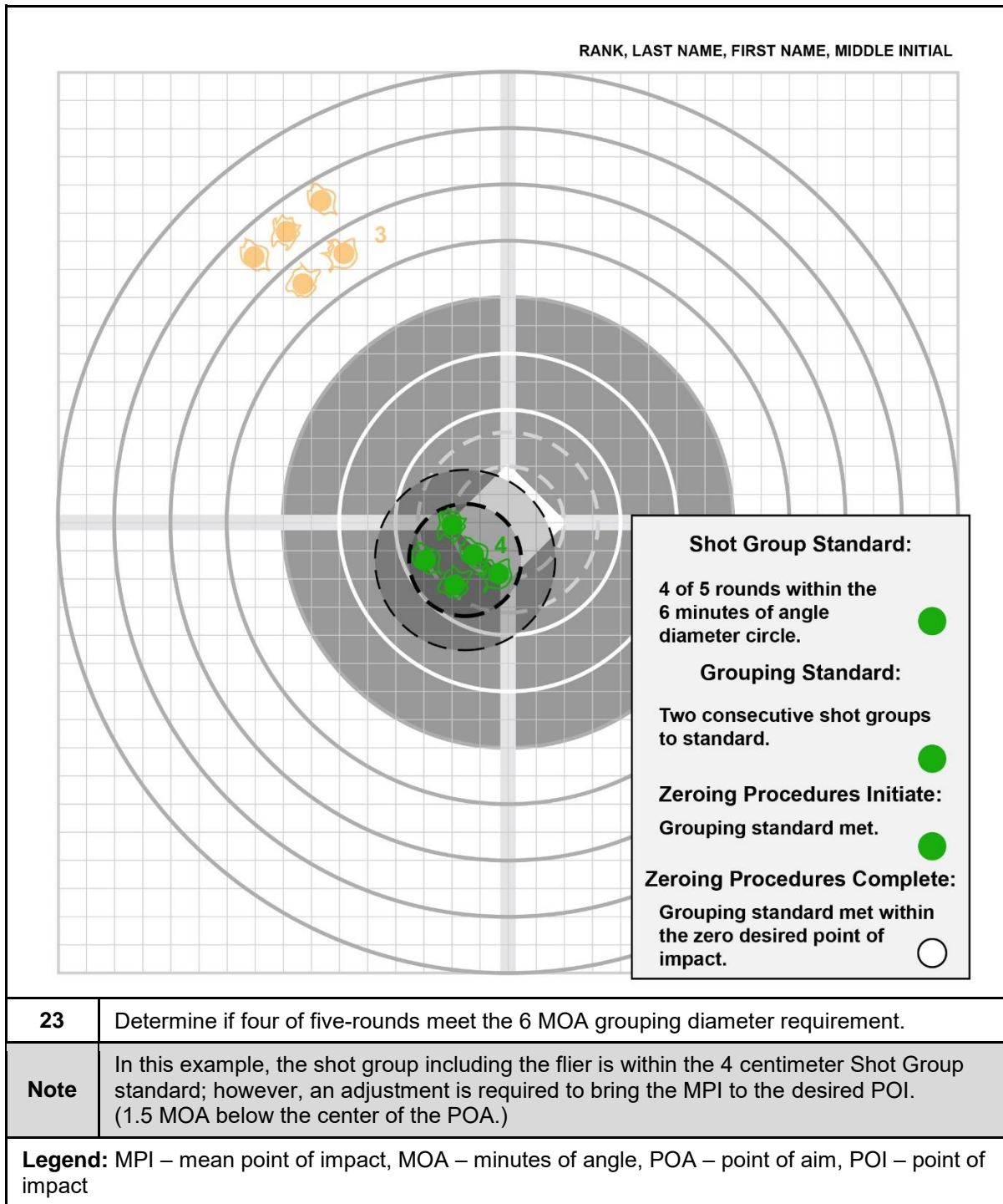

Figure E-14. Rifle and carbine zero group 1 standard determination

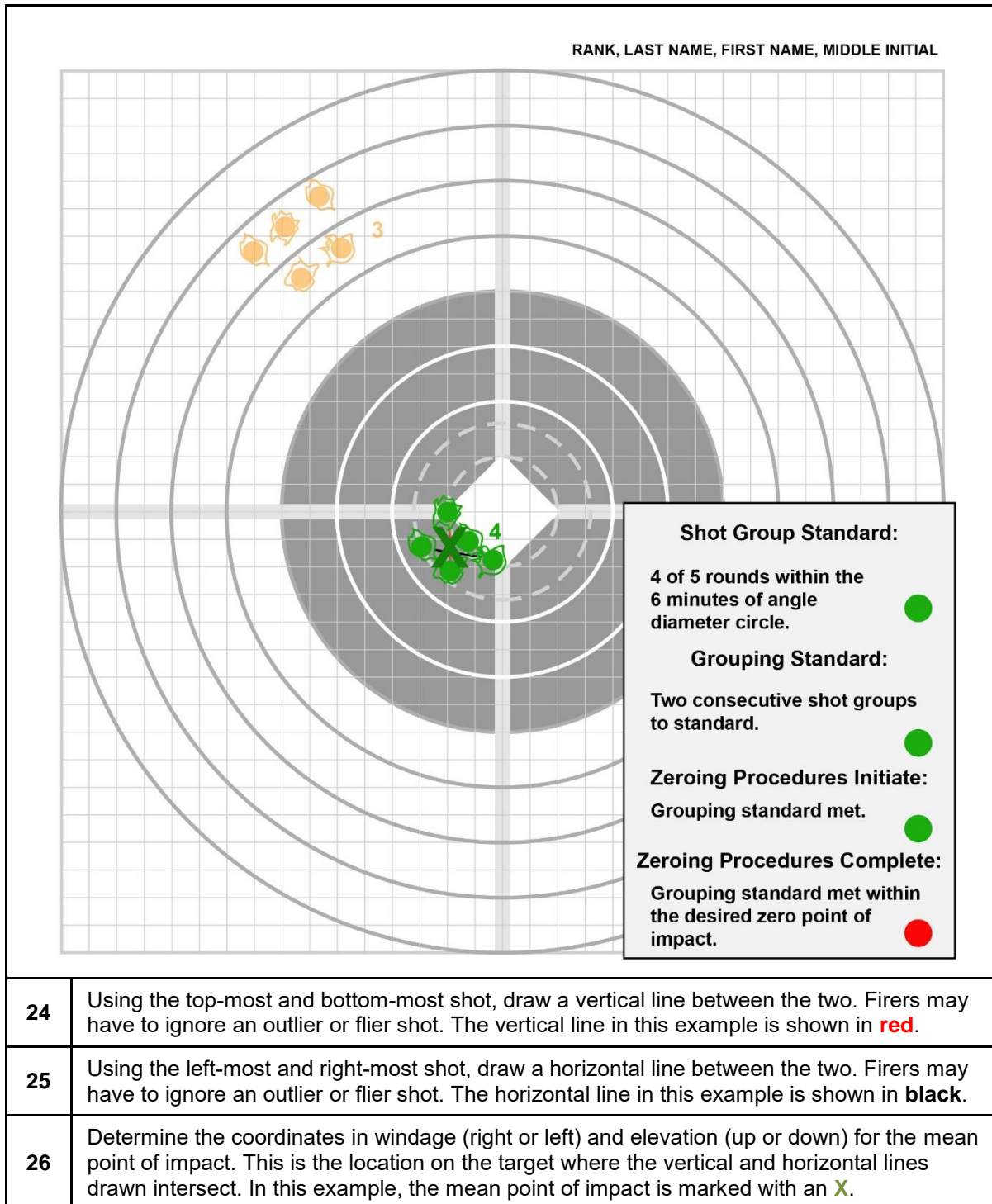

Figure E-15. Rifle and carbine zero group 1 mean point of impact determination

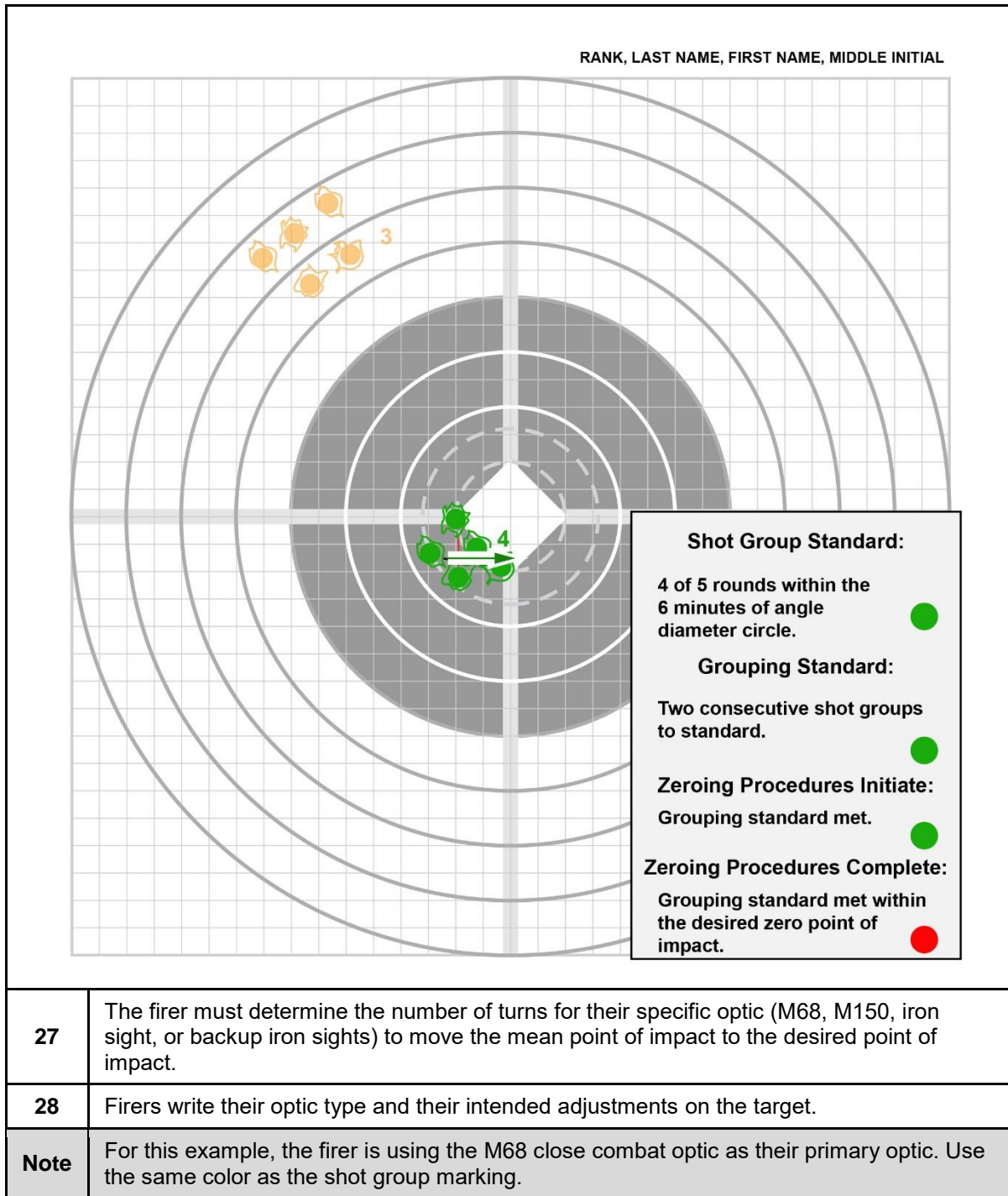

Figure E-16. Rifle and carbine mean point of impact adjustment determination

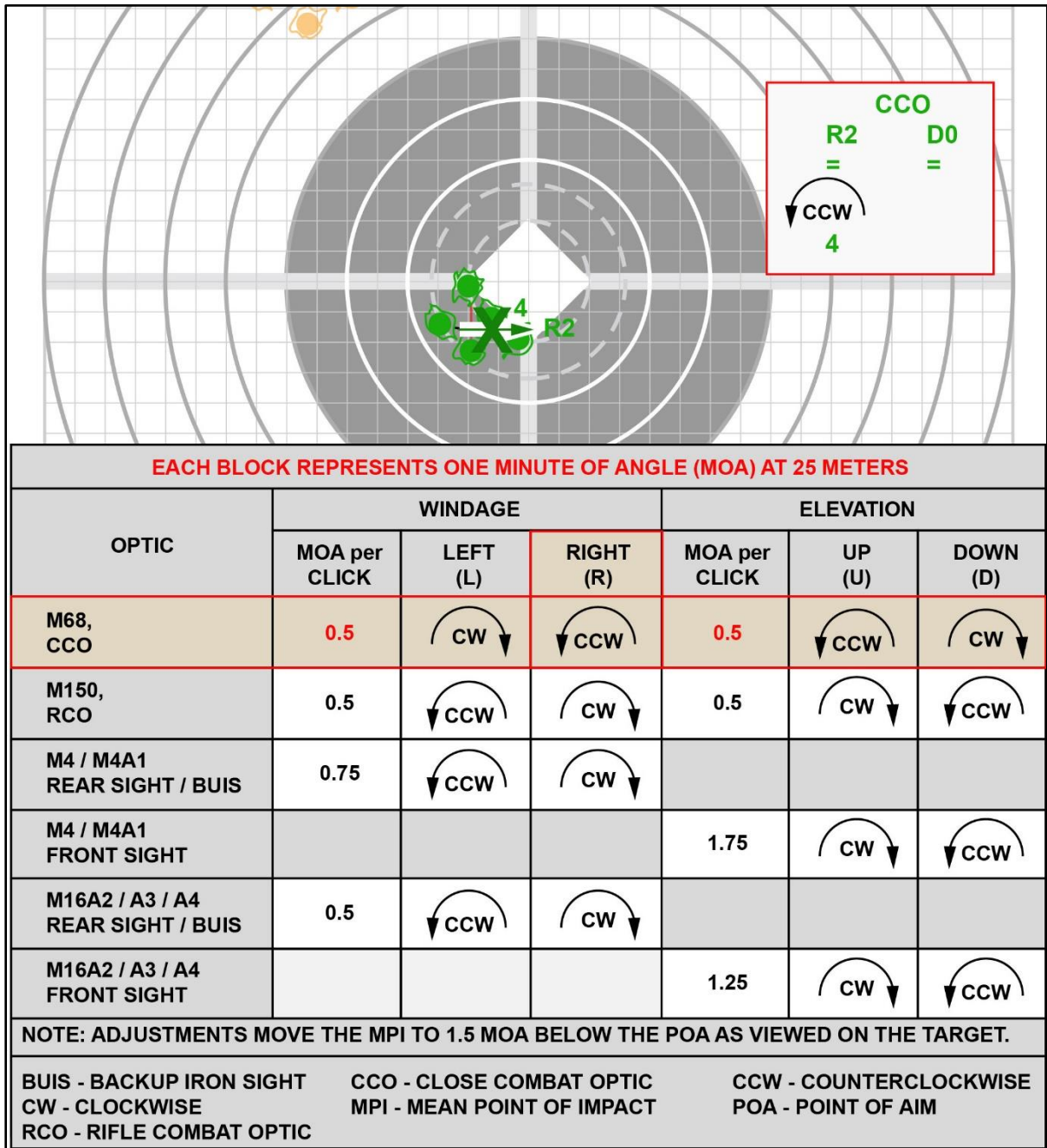

Figure E-17. Rifle and carbine mean point of impact adjustment application

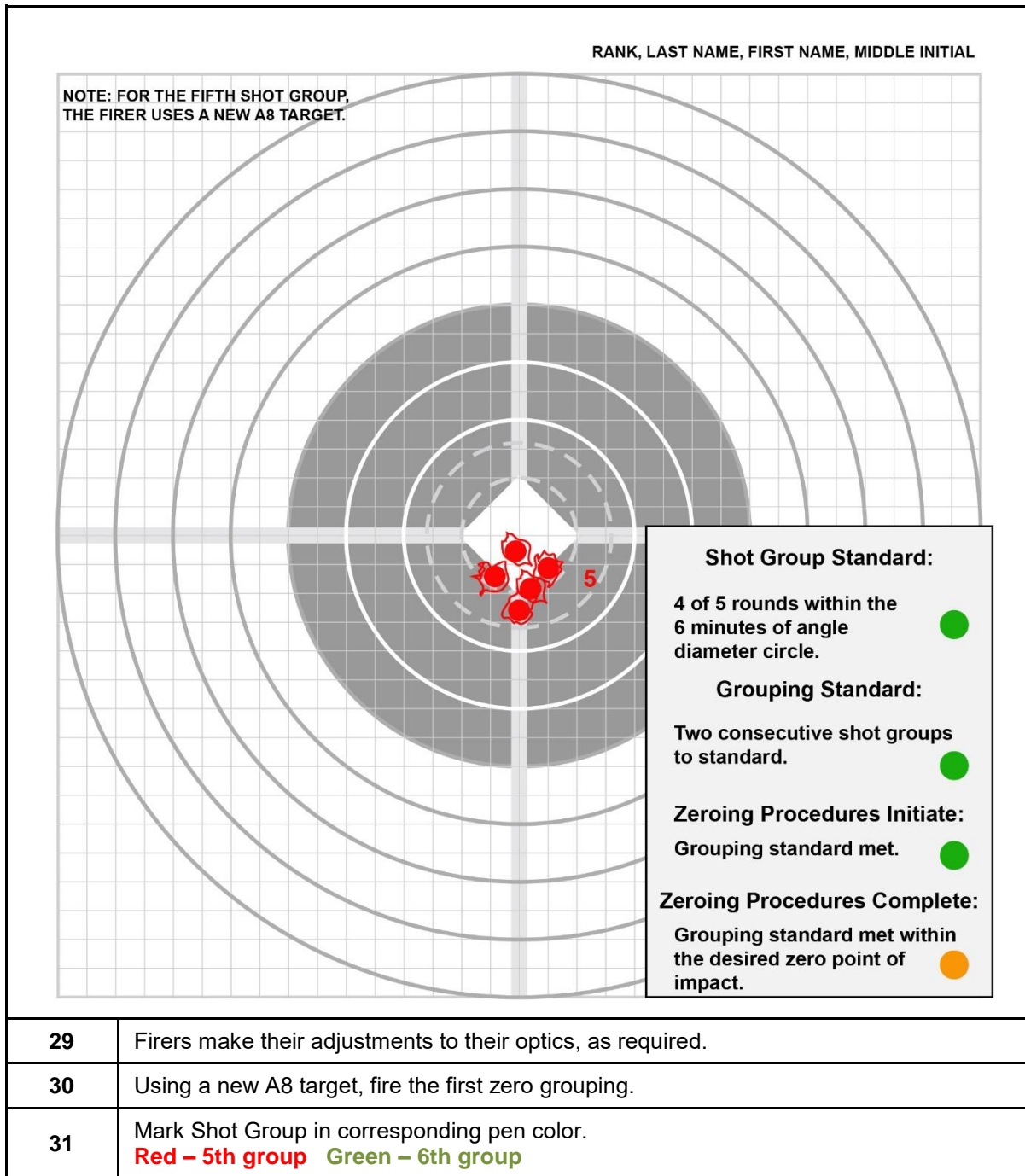

Figure E-18. Rifle and carbine zero group 2

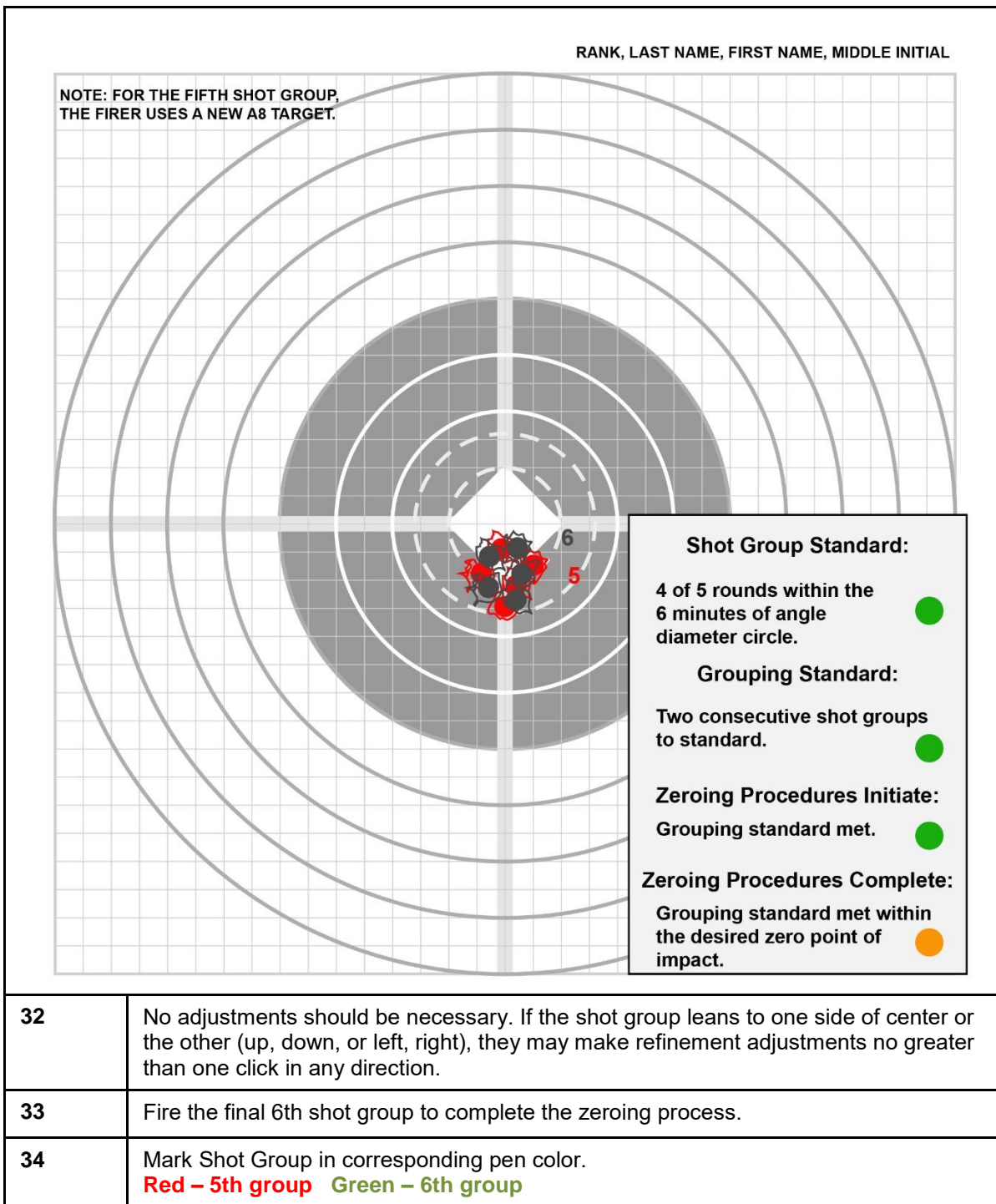

Figure E-19. Rifle and carbine zero group 3

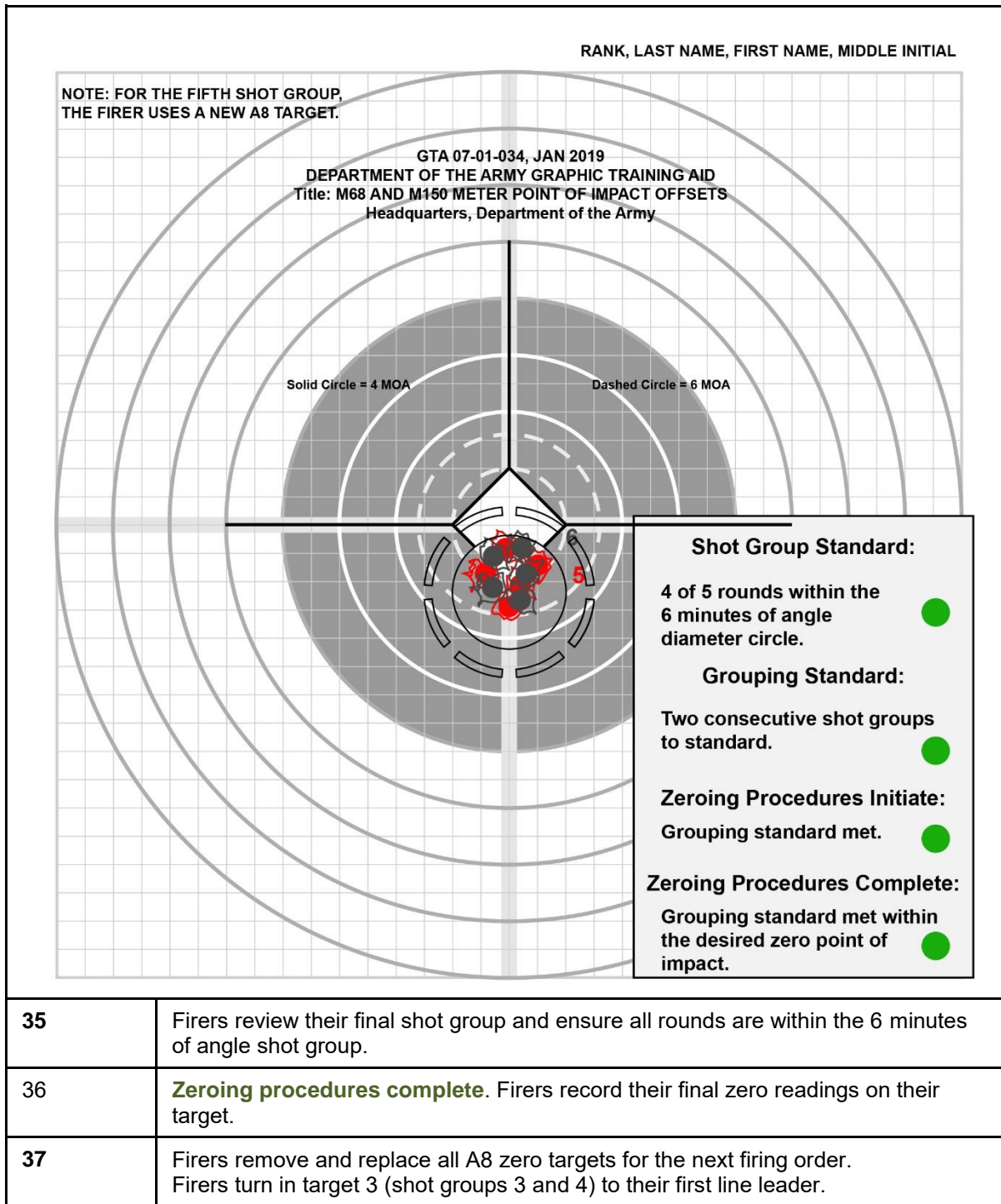
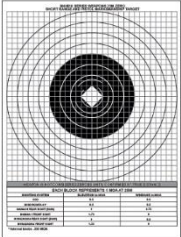
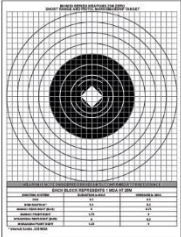
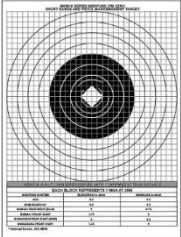

Figure E-20. Rifle and carbine zero standard achieved

E-35. Soldiers begin Table IV training by moving into the firing position following administrative commands from the tower operator. Administrative commands control the flow of the range, movement of personnel, and other command and control purposes. Table E-23 provides an example of the administrative commands for moving a new firing order into position.

E-36. Soldiers enter the range and move to their firing points. Once at the firing point, firers assume a standing firing position with rifle and carbines in a green weapons safety status. Firers fire the tasks in Table IV from the prone, supported position for each group.

Table E-23. Table IV, new firing order, conduct of the range example

| New Firing Order, Conduct of the Range | | | |
|--|---|---|-----------------------|
| 1 | 2 | 3 | |
|  |  |  | Task |
| | | | Target |
| | | | Target Type |
| | | | New Firing Order |
| | | | Rounds per Target |
| | | | DODIC |
| | | | Time (Seconds) |
| | | | N/A |
| | | | AB57 |
| | | | NO LIMIT |
| TOWER | | | SOLDIER ACTION |
| FIRERS ARE IN A GREEN STATUS | | | |
| CONDUCT OF THE RANGE FIRING ORDER (ONE) — SECURE YOUR WEAPON AND AMMUNITION ONCE COMPLETE, MOVE TO YOUR FIRING POINT. Soldiers secure their seven magazines, and move to their designated firing point. | | | |
| FIRERS ARE IN A GREEN STATUS | | | |
| Once all firers are at their FIRING POINT, the tower continues. | | | |
| Legend: DODIC – Department of Defense identification code, N/A – not applicable | | | |

Note. During any engagement when a malfunction occurs, Soldiers must apply immediate action to their weapon then continue the engagement, as appropriate. When immediate or remedial action does not correct the malfunction, Soldiers notify their respective lane safety.

E-37. As soon as the tower operator confirms all firers are at the appropriate firing point, the tower operator initiates the first engagement. Table E-24 lists the commands for the first engagement.

Table E-24. Table IV, engagement 1, first shot group, conduct of fire example

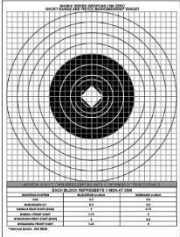
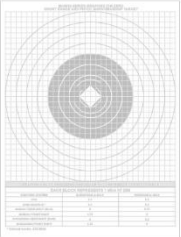
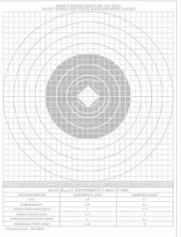
| <i>Table IV, Engagement 1 – First Shot Group</i> | | | | | |
|---|---|---|------------------------------|--|-----------------------|
| 1 | 2 | 3 | Group | Target | Target Type |
|  |  |  | 1 | A8 | Zero / Bull Ring |
| | | | Rounds per Engagement | DODIC | Time (Seconds) |
| | | | 5 | AB57/ AB46 | NO LIMIT |
| TOWER | | | SOLDIER ACTION | | |
| WEAPONS SAFETY STATUS RED | | GO TO PRONE MAKE READY | | Soldier moves to the PRONE supported position, establishes a good firing position, and loads one five-round magazine. | |
| ALERT | | FIRERS | | | |
| TARGET DESCRIPTION | | TARGET ONE | | Soldier acquires the designated A8 target. | |
| DIRECTION | | FRONT | | | |
| RANGE | | CLOSE QUARTERS | | Soldier acquires the target and identifies the target's point of aim (POA). | |
| CONTROL | | FIVE ROUNDS SLOW FIRE WEAPONS FREE WEAPONS FREE | | | |
| EXECUTION | | ENGAGE UPON POSITIVE IDENTIFICATION | | Soldier begins slow firing a five-round shot group, ensuring the same point of aim for each round. | |
| TOWER AWAITS ALL FIRERS TO COMPLETE THE FIVE-ROUND GROUP | | | | | |
| TERMINATION | | CEASE FIRE CEASE FIRE | | The firer's BOLT should be locked to the rear. Tower must assume all weapons are RED. | |
| WEAPONS SAFETY STATUS GREEN | | GO GREEN SHOW CLEAR | | Soldiers clear their weapons, show clear to the lane safety. | |
| Once all firers are complete, the tower directs: MOVE TO THE TARGET AND REVIEW YOUR SHOT GROUP. ONCE COMPLETE, RETURN TO THE FIRING POINT. | | | | | |
| Legend: DODIC – Department of Defense identification code | | | | | |

E-38. Once all firers have completed the first group, the firer and coach analyze the group to determine if improvements to the firer’s shot process are required. They mark the group prior to returning to the firing line. After all firers have returned from downrange the tower operator prepares for engagement 2, shown in table E-25. The tower operator’s initial command initiates the firer to GO TO PRONE and MAKE READY.

Table E-25. Table IV, engagement 2, second shot group, conduct of fire example

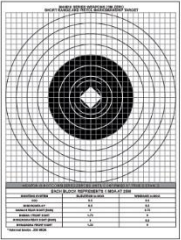
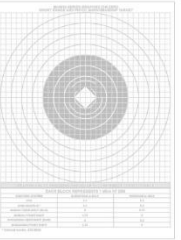
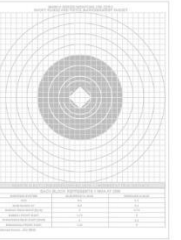
| <i>Table IV, Engagement 2 – Second Shot Group</i> | | | | | |
|---|---|---|--|--------------|-----------------------|
| 1 | 2 | 3 | Group | Target | Target Type |
|  |  |  | 2 | A8 | Zero / Bull Ring |
| | | | Rounds per Engagement | DODIC | Time (Seconds) |
| | | | 5 | AB57/ AB46 | NO LIMIT |
| TOWER | | | SOLDIER ACTION | | |
| WEAPONS SAFETY STATUS RED | | GO TO PRONE MAKE READY | Soldier moves to the PRONE supported position, establishes a good firing position, and loads one five-round magazine. | | |
| ALERT | FIRERS | | | | |
| TARGET DESCRIPTION | TARGET ONE | | Soldier acquires the designated A8 target. | | |
| DIRECTION | FRONT | | | | |
| RANGE | CLOSE QUARTERS | | Soldier acquires the target and identifies the target’s point of aim (POA). | | |
| CONTROL | FIVE ROUNDS SLOW FIRE WEAPONS FREE WEAPONS FREE | | | | |
| EXECUTION | ENGAGE UPON POSITIVE IDENTIFICATION | | Soldier begins slow firing a five-round shot group, ensuring the same point of aim for each round. | | |
| TOWER AWAITS ALL FIRERS TO COMPLETE THE FIVE-ROUND GROUP | | | | | |
| TERMINATION | CEASE FIRE CEASE FIRE | | The firer’s BOLT should be locked to the rear. Tower must assume all weapons are RED. | | |
| WEAPONS SAFETY STATUS GREEN | | GO GREEN SHOW CLEAR | Soldiers clear their weapons, show clear to the lane safety. | | |
| Once all firers are complete, the tower directs: MOVE TO THE TARGET AND REVIEW YOUR SHOT GROUP. ONCE COMPLETE, RETURN TO THE FIRING POINT. | | | | | |
| Legend: DODIC – Department of Defense identification code | | | | | |

E-39. After completing the second group, the firer and coach analyze the group to determine if improvements to the firer’s shot process are required and mark the group. Firers, who successfully demonstrate the ability to group, determine required adjustments and apply them to the aiming device. After all firers have returned to the firing line, the tower operator prepares for engagement 3 (see table E-26).

Table E-26. Table IV, engagement 3, third shot group, conduct of fire example

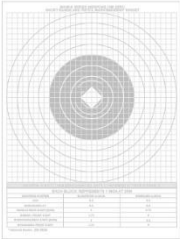
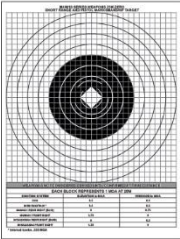
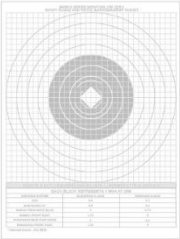
| <i>Table IV, Engagement 3 – Third Shot Group</i> | | | | | |
|---|---|---|------------------------------|--|-----------------------|
| 1 | 2 | 3 | Group | Target | Target Type |
|  |  |  | 3 | A8 | Zero / Bull Ring |
| | | | Rounds per Engagement | DODIC | Time (Seconds) |
| | | | 5 | AB57 | NO LIMIT |
| TOWER | | | SOLDIER ACTION | | |
| WEAPONS SAFETY STATUS RED | | GO TO PRONE MAKE READY | | Soldier moves to the PRONE supported position, establishes a good firing position, and loads one five-round magazine. | |
| ALERT | | FIRERS | | | |
| TARGET DESCRIPTION | | TARGET TWO | | Soldier acquires the designated A8 target. | |
| DIRECTION | | FRONT | | | |
| RANGE | | CLOSE QUARTERS | | | |
| CONTROL | | FIVE ROUNDS SLOW FIRE WEAPONS FREE WEAPONS FREE | | | |
| EXECUTION | | ENGAGE UPON POSITIVE IDENTIFICATION | | Soldier begins slow firing a five-round shot group, ensuring the same point of aim for each round. | |
| TOWER AWAITS ALL FIRERS TO COMPLETE THE FIVE-ROUND GROUP | | | | | |
| TERMINATION | | CEASE FIRE CEASE FIRE | | The firer’s BOLT should be locked to the rear. Tower must assume all weapons are RED. | |
| WEAPONS SAFETY STATUS GREEN | | GO GREEN SHOW CLEAR | | Soldiers clear their weapons, show clear to the lane safety. | |
| Once all firers are complete, the tower directs: MOVE TO THE TARGET AND REVIEW YOUR SHOT GROUP. ONCE COMPLETE, RETURN TO THE FIRING POINT. | | | | | |
| Legend: DODIC – Department of Defense identification code | | | | | |

E-40. Once all firers have completed the third group, annotated the appropriate adjustments on their target, and applied the adjustments to their weapon or optic, the tower operator prepares for engagement 4, shown in table E-27. Leaders should remove Soldiers who have not demonstrated the ability to group from the firing line and direct them to the appropriate area to receive remedial training.

Table E-27. Table IV, engagement 4, zeroing group one, conduct of fire example

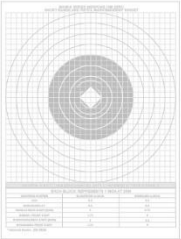
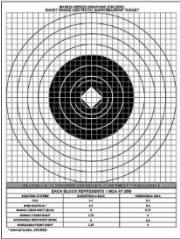
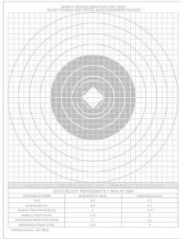
| <i>Table IV, Engagement 4 – Zeroing Group One</i> | | | | | |
|---|---|---|------------------------------|--|-----------------------|
| 1 | 2 | 3 | Group | Target | Target Type |
|  |  |  | 4 | A8 | Zero / Bull Ring |
| | | | Rounds per Engagement | DODIC | Time (Seconds) |
| | | | 5 | AB57 | NO LIMIT |
| TOWER | | | SOLDIER ACTION | | |
| WEAPONS SAFETY STATUS RED | | GO TO PRONE MAKE READY | | Soldier moves to the PRONE supported position, establishes a good firing position, and loads one five-round magazine. | |
| ALERT | | FIRERS | | | |
| TARGET DESCRIPTION | | TARGET TWO | | Soldier acquires the designated A8 target. | |
| DIRECTION | | FRONT | | | |
| RANGE | | CLOSE QUARTERS | | Soldier acquires the target and identifies the target's point of aim (POA). | |
| CONTROL | | FIVE ROUNDS SLOW FIRE WEAPONS FREE WEAPONS FREE | | | |
| EXECUTION | | ENGAGE UPON POSITIVE IDENTIFICATION | | Soldier begins slow firing a five-round shot group, ensuring the same point of aim for each round. | |
| TOWER AWAITS ALL FIRERS TO COMPLETE THE FIVE-ROUND GROUP | | | | | |
| TERMINATION | | CEASE FIRE CEASE FIRE | | The firer's BOLT should be locked to the rear. Tower must assume all weapons are RED. | |
| WEAPONS SAFETY STATUS GREEN | | GO GREEN SHOW CLEAR | | Soldiers clear their weapons, show clear to the lane safety. | |
| Once all firers are complete, the tower directs: MOVE TO THE TARGET AND REVIEW YOUR SHOT GROUP. ONCE COMPLETE, RETURN TO THE FIRING POINT. | | | | | |
| Legend: DODIC – Department of Defense identification code | | | | | |

E-41. Once all firers have completed the first zeroing group, annotated the appropriate adjustments on their targets, and applied the adjustments to their weapons or optics, the tower operator prepares for engagement 5, shown in table E-28.

Table E-28. Table IV, engagement 5, zeroing group two, conduct of fire example

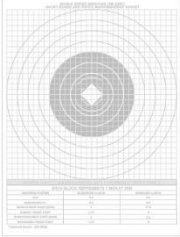
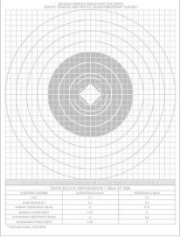
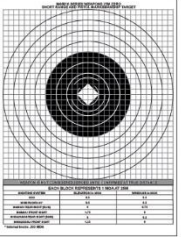
| <i>Table IV, Engagement 5 – Zeroing Group Two</i> | | | | | |
|---|---|---|--|--------|------------------|
| 1 | 2 | 3 | Zeroing Group | Target | Target Type |
|  |  |  | 1 | A8 | Zero / Bull Ring |
| | | | Rounds per Engagement | DODIC | Time (Seconds) |
| | | | 5 | AB57 | NO LIMIT |
| TOWER | | | SOLDIER ACTION | | |
| WEAPONS SAFETY STATUS RED | | GO TO PRONE MAKE READY | Soldier moves to the PRONE supported position, establishes a good firing position, and loads one five-round magazine. | | |
| ALERT | FIRERS | | | | |
| TARGET DESCRIPTION | TARGET THREE | | Soldier acquires the designated A8 target. | | |
| DIRECTION | FRONT | | | | |
| RANGE | CLOSE QUARTERS | | Soldier acquires the target and identifies the target's point of aim (POA). | | |
| CONTROL | FIVE ROUNDS SLOW FIRE WEAPONS FREE WEAPONS FREE | | | | |
| EXECUTION | ENGAGE UPON POSITIVE IDENTIFICATION | | Soldier begins slow firing a five-round shot group, ensuring the same point of aim for each round. | | |
| TOWER AWAITS ALL FIRERS TO COMPLETE THE FIVE-ROUND GROUP | | | | | |
| TERMINATION | CEASE FIRE CEASE FIRE | | The firer's BOLT should be locked to the rear. Tower must assume all weapons are RED. | | |
| WEAPONS SAFETY STATUS GREEN | GO GREEN SHOW CLEAR | | Soldiers clear their weapons, show clear to the lane safety. | | |
| Once all firers are complete, the tower directs: MOVE TO THE TARGET AND REVIEW YOUR SHOT GROUP. ONCE COMPLETE, RETURN TO THE FIRING POINT. | | | | | |
| Legend: DODIC – Department of Defense identification code | | | | | |

E-42. Once all firers have completed zeroing group two, annotated the appropriate adjustments on their targets, and applied the adjustments to their weapons or optics, the tower operator prepares for engagement 6, shown in table E-29. The tower operator’s initial command initiates the firer to GO TO PRONE and MAKE READY.

Table E-29. Table IV, engagement 6, zeroing group three, conduct of fire example

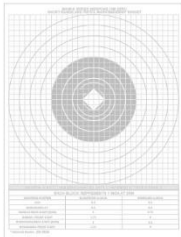
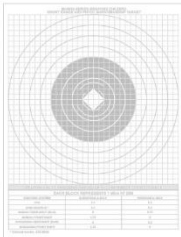
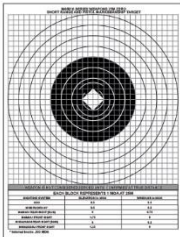
| <i>Table IV, Engagement 6 – Zeroing Group Three</i> | | | | | | | | | | | |
|---|--|--|---|--|--|--|--|--|-----------------------|--------|------------------|
| 1 | | | 2 | | | 3 | | | Zeroing Group | Target | Target Type |
|  | | |  | | |  | | | 2 | A8 | Zero / Bull Ring |
| | | | | | | | | | Rounds per Engagement | DODIC | Time (Seconds) |
| | | | | | | | | | 5 | AB57 | NO LIMIT |
| TOWER | | | | | | SOLDIER ACTION | | | | | |
| WEAPONS SAFETY STATUS RED | | | GO TO PRONE MAKE READY | | | Soldier moves to the PRONE supported position, establishes a good firing position, and loads one five-round magazine. | | | | | |
| ALERT | | | FIRERS | | | | | | | | |
| TARGET DESCRIPTION | | | TARGET THREE | | | Soldier acquires the designated A8 target. | | | | | |
| DIRECTION | | | FRONT | | | | | | | | |
| RANGE | | | CLOSE QUARTERS | | | Soldier acquires the target and identifies the target’s point of aim (POA). | | | | | |
| CONTROL | | | FIVE ROUNDS SLOW FIRE WEAPONS FREE WEAPONS FREE | | | | | | | | |
| EXECUTION | | | ENGAGE UPON POSITIVE IDENTIFICATION | | | Soldier begins slow firing a five-round shot group, ensuring the same point of aim for each round. | | | | | |
| TOWER AWAITS ALL FIRERS TO COMPLETE THE FIVE-ROUND GROUP | | | | | | | | | | | |
| TERMINATION | | | CEASE FIRE CEASE FIRE | | | The firer’s BOLT should be locked to the rear. Tower must assume all weapons are RED. | | | | | |
| WEAPONS SAFETY STATUS GREEN | | | GO GREEN SHOW CLEAR | | | Soldiers clear their weapons, show clear to the lane safety. | | | | | |
| Once all firers are complete, the tower directs: MOVE TO THE TARGET, REVIEW YOUR SHOT GROUP, REMOVE TARGETS AND REPLACE WITH FRESH TARGETS. ONCE COMPLETE, RETURN TO THE FIRING POINT. | | | | | | | | | | | |
| Legend: DODIC – Department of Defense identification code | | | | | | | | | | | |

E-43. Once all firers have recovered their targets and placed fresh A8 targets on the target frame, firers collect their brass, ammunition, and magazines from their firing positions after which the lane safety clears them. Once complete, the lane safety communicates the WSS to the tower operator and the tower operator issues an administrative command moving the Soldiers off the range.

E-44. The tower operator may direct certain firers to remain on the firing point, as necessary. Those firers include Soldiers assigned both a BUIS and CCO or RCO, and who still need to zero the second aiming device. Those Soldiers require additional ammunition to complete the requisite tasks.

E-45. During the range reconnaissance, the unit determines if the 25-meter target frame interferes with the firer's ability to acquire and engage the zero confirmation target. Where the 25-meter target frame presents a line-of-sight issue to the zero confirmation target, units should bypass the confirmation process. When the zero confirmation target cannot be safely or effectively used with the 25-meter target frame emplaced, units conduct confirmation at distance (one each, five-round magazine) by—

- Completing all firing orders through grouping and zeroing tasks, then removing the target frames from the range while in a cold or dry status.
- Completing stage 3 confirmation at distance and stage 4 application of hold-offs prior to conducting Table V (when using a separate facility).

E-46. Table E-30 and Table E-31, on page E-50, provides the conduct of fire for stage 3 and stage 4. All firers must have completed making adjustments to their aiming devices and recorded their final zero information for their weapon and optic prior to confirming at distance or applying hold-offs to the 100-meter and 200 -meter target. All weapons are initially in a green status.

Table E-30. Table IV, engagement 7, confirmation of distance, conduct of fire example

| Table IV, Engagement 7 – Zero Confirmation at Distance | | | |
|---|--|--|-------------------------------------|
|  <p>300 meter (Unit may select different zero range based on their SOP, TTP, or mission requirements).</p> | Zero Confirmation | Target | Target Type |
| | 1 | E-1 or D-1 | Silhouette, kneeling (hit-bob mode) |
| | Rounds per Engagement | DODIC | Time (Seconds) |
| | 5 | AB57 | NO LIMIT |
| TOWER | | SOLDIER ACTION | |
| WEAPONS SAFETY STATUS RED | GO TO PRONE MAKE READY | Soldier moves to the PRONE supported position, establishes a good firing position, and loads one five-round magazine. | |
| ALERT | FIRERS | | |
| TARGET DESCRIPTION | TROOP | Soldier acquires the zero confirmation target. | |
| DIRECTION | FRONT | | |
| RANGE | THREE-HUNDRED | Soldier acquires the target and identifies the target's center of visible mass (known as CoVM). | |
| CONTROL | FIVE ROUNDS SLOW FIRE WEAPONS FREE WEAPONS FREE | | |
| EXECUTION | ENGAGE UPON POSITIVE IDENTIFICATION | Soldier begins slow firing a five-round shot group, ensuring the same point of aim for each round. | |
| ONCE ALL FIRERS ARE COMPLETE WITH THE FIVE-ROUND CONFIRMATION AT DISTANCE: | | | |
| TERMINATION | CEASE FIRE CEASE FIRE | The firer's BOLT should be locked to the rear. Tower must assume all weapons are RED. | |
| WEAPONS SAFETY STATUS GREEN | GO GREEN SHOW CLEAR | Soldiers clear their weapons, show clear to the lane safety. | |
| Firer's should achieve four of five hits to successfully complete confirmation at distance. The tower should identify any firer that has not met the confirmation standard and move those Soldiers to the retraining location. | | | |
| Legend: DODIC – Department of Defense identification code, SOP – standard operating procedure, TTP – tactics, techniques, and procedures, | | | |

E-47. Once all firers have completed stage 3, they remain in place and await further instructions from the tower operator. The tower operator instructs them to reload and prepare for stage 4. Table E-31 shows an example of the conduct of fire for Table IV, stage 4.

Table E-31. Table IV, engagement 8, application of hold-offs, conduct of fire example

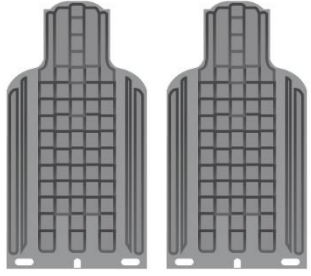
| <i>Table IV, Engagement 8 – Application of Hold-Offs</i> | | | |
|---|--|---|-------------------------------------|
|  <p>100 and 200 meter</p> | Application of Hold-Offs | Target | Target Type |
| | 1 | E-1 or D-1 | Silhouette, kneeling (hit-bob mode) |
| | Rounds per Engagement | DODIC | Time (Seconds) |
| | 10 | AB57 | 55 |
| TOWER | | SOLDIER ACTION | |
| WEAPONS SAFETY STATUS RED | MAKE READY | Soldier remains in the PRONE supported position, establishes a good firing position, and loads one 10-round magazine. | |
| ALERT | FIRERS | | |
| TARGET DESCRIPTION | TROOPS | Soldier acquires the 100 meter target. | |
| DIRECTION | FRONT | | |
| RANGE | ONE-HUNDRED AND TWO HUNDRED | Soldier acquires the target and identifies the target's center of visible mass (known as CoVM). | |
| CONTROL | FIVE ROUNDS SLOW FIRE WEAPONS FREE WEAPONS FREE | | |
| EXECUTION | ENGAGE UPON POSITIVE IDENTIFICATION | Soldier begins slow firing a five-round shot group, applying the appropriate hold-off at the 100 meter target and again at the 200 meter target. | |
| ONCE ALL FIRERS ARE COMPLETE WITH THE 10-ROUND APPLICATION OF HOLD-OFF: | | | |
| TERMINATION | CEASE FIRE CEASE FIRE | The firer's BOLT should be locked to the rear. Tower must assume all weapons are RED. | |
| WEAPONS SAFETY STATUS GREEN | GO GREEN SHOW CLEAR | Soldiers clear their weapons, show clear to the lane safety. | |
| Firer's should achieve 4 of 5 hits on each target to successfully complete application of hold-offs. The tower should identify any firer that has not met the standard and move those Soldiers to the retraining location. | | | |
| Legend: DODIC – Department of Defense identification code, SOP – standard operating procedure, TTP – tactics, techniques, and procedures, | | | |

E-48. Once all firers have been verified green by the lane safety, the tower operator directs the firing order off the baseline. The tower operator must identify Soldiers who have failed to achieve the confirmation at distance standard (4 of 5 hits at zeroing distance) and move those Soldiers to a predetermined retraining location.

E-49. Table E-32 provides a generic example of the conduct of the range instructions to change firing orders. All firers on the range are in a green status.

Table E-32. Table IV, completed firing order, conduct of the range example

| <i>Completed Firing Order, Conduct of the Range</i> | | | |
|---|--|--|----------------|
| FIRING ORDER COMPLETE | Task | Target | Target Type |
| | Completed Firing Order | N/A | N/A |
| | Rounds per Target | DODIC | Time (Seconds) |
| | N/A | N/A | NO LIMIT |
| TOWER | | SOLDIER ACTION | |
| FIRERS ARE IN A GREEN STATUS | | | |
| CONDUCT OF THE RANGE | SECURE YOUR DUNNAGE, MAGAZINES, AND AMMUNITION ONCE SET, MOVE TO THE BASELINE ENTRY CONTROL POINT | Firers secure weapon and ammunition dunnage and move to the designated location. | |
| ONCE ALL FIRERS HAVE EXITED THROUGH THE BASELINE ENTRY CONTROL POINT, THE TOWER DIRECTS THE MOVEMENT OF THE NEXT FIRING ORDER. | | | |
| Legend: DODIC – Department of Defense identification code, N/A – not applicable | | | |

E-50. Leaders review the shot groups with their Soldiers and collect their grouping and zeroing targets for an AAR and verification of zeroing data. Leaders should maintain a record of the zeroing information, and review the targets for any firer errors during the shot process.

E-51. The tower operator records the completion of the firing order in the tower log and includes the number of Soldiers trained. This information is tabulated at the end of the firing day to change the firing status of the range to a cold and dry status with range operations.

RIFLE AND CARBINE, TABLE V, PRACTICE

E-52. Table V, Practice, is a practice table to use in preparation for the qualification course of fire. Table V tasks challenge firers with single and multiple stationary targets between 50- and 300-meters, from the prone unsupported, prone supported, kneeling supported, and standing supported firing positions. Leaders use Table V to train the firer to engage single and multiple targets placed in a tactical array using their primary optic and to apply the functional elements of the shot process. In a timed scenario, the firer experiences and learns target prioritization and weapons manipulation. This event is purposely more rigorous than the qualification event where the targets are presented in a rapid tempo. The time to transition between firing

positions and tactical reloading are reduced during this event. The practice event induces periodic weapon malfunctions using DDI munitions in the firers' magazines in a random fashion. Table V occurs on an ARF or comparable range facility.

TASK, CONDITIONS, AND STANDARD

E-53. Table E-33 outlines the tasks, conditions, and standards for Table V training. The firer conducting the event should know the tasks, conditions, and standards and should explain them during the range briefing conduct.

Table E-33. Rifle and Carbine, Table V, Practice

| | |
|--------------------|---|
| Task: | Engage and defeat single and multiple threats at varying ranges from supported or unsupported standing, kneeling, and prone firing positions, during day and limited visibility conditions using ball ammunition. |
| Conditions: | Given the following: <ul style="list-style-type: none"> • Fully mission capable weapon as assigned on the master authorization list for the unit. • Full combat uniform, issued equipment, and protective mask. • Authorized range facility. • Full-scale, approved targetry in standard scenario engagement sequences. • Authorized ammunition. |
| Standard: | Demonstrate engagement proficiency by hitting 70 percent (28 of 40) of all presented targets in the time allotted. |

E-54. Table E-34 shows the training event design template for Rifle and Carbine, Table V, Practice. Leaders conduct this event on an authorized live-fire facility, typically an ARF or comparable range facility. See TC 25-8 for additional information on authorized range facilities.

Table E-34. Training event design template for Rifle and Carbine, Table V, Practice

| <i>Rifle and Carbine, Table V, Practice</i> | | | | | | | |
|--|---------------|---------------------------|-------------------------|---------------------------------------|--------------------------|---------------------------------|---------------------|
| EVENT NAME: | PRACTICE | ENVIRONMENT: | | LIVE | 1.0 | | |
| WEAPON: | M4 / M16 | CONDITIONS: | | LIVE FIRE | | | |
| CATEGORY: | FOUNDATION | PRIMARY FACILITY: | | ARF | DAYS REQUIRED | | |
| PUBLICATION: | TC 3-22.9 | ALTERNATE FACILITY: | | QTR | | | |
| REQUIRED: | OPT | COMPONENT: | AC | RC | 120 SOLDIERS | | |
| RECORD: | DA Form 7801 | FREQUENCY: | 2 | 1 | | | |
| VALID FOR: | T-X | ANNUAL DAYS TOTAL: | 2 | 1 | THROUGHPUT | | |
| TABLE | | | | | | | |
| | | I | II | III | IV | V | VI |
| | | PMI&E | PLFS | DRILLS | BASIC | PRACTICE | QUAL |
| | | PRQ | PRQ | PRQ | | | 1.0 |
| WHEN EXECUTED: | | | | | | T-X | TNG DAYS TO QUAL |
| CONDEMNATION CRITERIA (CC) | RULE 1 | RULE 2 | RULE 3 | RULE 4 | RULE 5 | RULE 6 | |
| | TIME | KEY LEADER TURNOVER | COMMANDER ASSESSMENT | SUBORDINATE ELEMENT PROFICIENCY | SPECIALTY PROFICIENCY | STAFF SECTION PROFICIENCY | |
| Remarks: Each Soldier assigned an individual weapon <i>should</i> successfully complete Table V, Practice, to gain experience with and confidence in their weapon, aiming devices, and skill. | | | | | | | |
| Legend: AC – active component (known as active duty), ARF – automated record fire range or similar, DA – Department of the Army, OPT – optional, PLFS – preliminary live-fire simulation, PMI&E – preliminary marksmanship instruction and evaluation, PRQ – prerequisite, QTR – qualification training range, QUAL – qualification, RC – Reserve Component (known as Reserves), TC – training circular, T-X – training event exercise, TNG DAYS TO QUAL – number of training days remaining on the critical path to weapon's qualification | | | | | | | |

AMMUNITION

E-55. All Soldiers assigned a rifle or carbine on a unit MAL should complete the tasks listed in Rifle and Carbine, Table V, Practice prior to advancing to Table VI, Qualification tasks. Leaders conduct this event to demonstrate the Soldier's proficiency to employ a rifle or carbine during a close quarters fight prior to conducting the qualification course of fire, Table VI.

E-56. To effectively plan and forecast for sufficient training ammunition, the unit uses the ammunition requirements listed in table E-35, on page E-54. Units need to identify the number of firers and should plan for unscheduled firers and necessary retraining by increasing their forecasted training, as appropriate.

Table E-35. Rifle and Carbine, Table V, Practice ammunition requirements

| <i>Training Event</i> | <i>DODIC</i> | <i>Nomenclature</i> | <i>Quantity</i> | <i>Remarks</i> |
|--|--------------|--|-----------------|--|
| Table IV, Stage 3 Confirmation at Distance | AB57 | CTG, 5.56mm, ball, M855A1 EPR | 5 | Conducted prior to Table V on the ARF or comparable facility when range restrictions or line- of-sight issues prevent completion of the task during Table IV. |
| Table IV, Stage 4 Application of Hold- Offs | AB57 | CTG, 5.56mm, ball, M855A1 EPR | 10 | Conducted prior to Table V on the ARF or comparable facility when range restrictions or line- of-sight issues prevent completion of the task during Table IV. |
| Note. Table IV, Stages 3 and 4 must be completed before Table V, Stage 1. | | | | |
| Table V, Stage 1 Practice | AB57 | CTG, 5.56mm, ball, M855A1 EPR | 40 | One round per target is required. |
| | AB46 | CTG, 5.56mm, single round, DDI), M199A1 | 1 | Used to reinforce clearing malfunctions and to identify recoil anticipation. |
| Legend: ARF – automated record fire range, CTG – cartridge, DDI – dummy, drilled, inert; DODIC – Department of Defense identification code, EPR – enhanced performance round, mm – millimeter | | | | |

E-57. Table V is an automated timed event that consists of four live-fire phases. Leaders issue every firer ammunition as shown in table E-36 to conduct the event to standard. Firers place these magazines in their magazine pouches. Staging or pre-positioning magazines is not authorized for the conduct of Table V training.

Table E-36. Rifle and Carbine, Table V, Practice ammunition breakdown

| <i>Phase</i> | <i>Sequence / Magazine</i> | <i>AB57 5.56mm, Ball</i> | <i>AB46 5.56mm, DDI</i> | <i>Magazine Total Rounds</i> |
|---|--------------------------------|------------------------------|-----------------------------|----------------------------------|
| Prone, unsupported | 1 | 10 each | 1 round random | 10 rounds |
| Prone, supported | 2 | 10 each | | 10 rounds |
| Kneeling, supported | 3 | 10 each | | 10 rounds |
| Standing, supported | 4 | 10 each | | 10 rounds |
| Note: Units will place one single DDI AB46 round into one of the firers' four magazines. The DDI rounds may not be the first or last rounds loaded in that magazine. | | | | |
| In lieu of DDI ammunition, units may use expended cartridges. Blank ammunition is NOT authorized on a live fire range. | | | | |
| Legend: DDI – dummy, drilled, inert; mm – millimeter | | | | |

RANGE FACILITIES

E-58. Table E-37 shows the Army-standard range facilities specifically designed to support rifle and carbine, Table V, Practice. Units must refer to their installation's range operations SOPs or local training regulation to identify the weapon-specific range facilities. Units use their RFMSS system for all scheduling.

Table E-37. Rifle and Carbine, Table V, Practice authorized range facilities

| <i>Table V</i> | <i>Targetry</i> | <i>Range Facility</i> | |
|--|---|-----------------------|------------|
| | | <i>ARF</i> | <i>QTR</i> |
| Practice | E-type, E1, target, silhouette: plastic, polyethylene, kneeling (NSN: 6920-00-071-4780) F-type, F-1, target, silhouette: plastic, polyethylene, prone (NSN 6920-00-071-4589) | P | A |
| | D-type, D1, target, silhouette: plastic, mannequin, kneeling (NSN 6920-01-164-9625) D-type, D-2, target, 3-Dimensional: plastic, mannequin, prone (NSN 6920-01-387-6397) | P | A |
| Legend: A – alternate, ARF- automated record fire range, NSN – national stock number, P – primary, QTR – qualification training range | | | |

TARGETRY

E-59. Table V tasks require silhouette targetry, either E-type, F-type, or D-type targets on the range. Leaders must confirm the type and capability of the range’s targetry, lifting mechanisms, and simulators. They must also identify any unit requirements. During the preparation phase, leaders should be familiar with the targetry used and the sequence of the firing events. Figure E-21 shows the authorized targetry used during Table V training.





| | |
|---|---|
| <p>E-1 Target, silhouette: plastic, polyethylene, kneeling NSN 6920-00-071-4780</p> | <p>D-1 Target, 3-dimensional: plastic, mannequin, kneeling NSN 6920-01-164-9625</p> |
|  |  |
| <p>F-1 Target, silhouette: plastic, polyethylene, prone NSN 6920-00-071-4589</p> | <p>D-2 Target, 3-dimensional: plastic, mannequin, prone NSN 6920-01-387-6397</p> |
|  <p>Prone targets are used only on the 50-meter RIGHT emplacement.</p> |  <p>Prone targets are used only on the 50-meter RIGHT emplacement.</p> |
| <p>Notes:</p> <p>Use of the E-1 or D-1 kneeling targets is at the discretion of the installation. Both represent dismounted, kneeling Infantry targets on small arms and maneuver facilities.</p> <p>Use F-1 or D-2 on the right 50-meter target emplacement only.</p> <p>Use of the G-2 prone target is not authorized.</p> | |
| <p>Legend: NSN – national stock number</p> | |

Figure E-21. Table V, authorized target types

SCENARIO ENGAGEMENTS

E-60. Targets are presented to the firer in single and multiple target arrays. Targets are presented so that 90-percent of the target is clearly visible to the firer from the expected or planned firing position. Targets are exposed to the firer based on the number of targets presented during the engagement as follows:

- Single target engagements are exposed for 3 seconds.
- Double target engagements are exposed for 5 seconds.
- Triple target engagements are exposed for 12 seconds.
- Quadruple target engagements are exposed for 16 seconds.

E-61. There is a 2-second delay between each engagement. After each phase (prone unsupported, prone supported, kneeling supported, and standing supported), there is an 8-second transition delay, which provides the firer time to conduct an emergency reload and assume the next specified position. Table E-38 shows the scenario engagement sequence for Table V training.

Table E-38. Rifle and carbine, Table V, Practice, engagement sequence

| <i>Table V, Practice, Engagements 1 through 5, React to Contact, Transition to Prone, Unsupported</i> | | | |
|---|--------------------|---------------|----------------------|
| Engagement | Target Type | Range | Exposure Time |
| 1 | F-type | 50 m RIGHT | 3 sec |
| 2 | E-type | 100 m | 3 sec |
| 3 | E-type | 150 m | 3 sec |
| 4 | E-type | 50 m LEFT | 12 sec |
| | E-type | 150 m | |
| | E-type | 200 m | |
| 5 | E-type | 150 m | 16 sec |
| | E-type | 200 m | |
| | E-type | 250 m | |
| | E-type | 300 m | |
| Prone, Unsupported, Time per Firing Order Total | | | 56 sec |
| <p>Note: There is a 5-second delay between the first and second engagement to allow the Soldier to go to prone. There is a 2-second delay between all other engagements in this table. An 8-second delay time is incorporated at the end of engagement 5 to facilitate magazine and firing position changes.</p> | | | |
| <p>Legend: m – meters; sec – seconds</p> | | | |

Table E-38. Rifle and Carbine, Table V, Practice Engagement sequence (continued)

| <i>Table V, Practice, Engagements 6 through 10, Prone, Supported</i> | | | |
|--|--------------------|--------------|----------------------|
| <i>Engagement</i> | <i>Target Type</i> | <i>Range</i> | <i>Exposure Time</i> |
| 6 | E-type | 100 m | 3 sec |
| 7 | E-type | 150 m | 5 sec |
| | E-type | 300 m | |
| 8 | E-type | 200 m | 5 sec |
| | E-type | 300 m | |
| 9 | E-type | 250 m | 5 sec |
| | E-type | 300 m | |
| 10 | E-type | 150 m | 12 sec |
| | E-type | 250 m | |
| | E-type | 300 m | |
| Prone, Supported, Time per Firing Order Total | | | 46 sec |
| Note: There is a 2-second delay between all engagements. An 8-second delay time is incorporated at the end of engagement 10 to facilitate magazine and firing position changes. | | | |
| Legend: m – meters; sec – seconds | | | |

Table E-38. Rifle and Carbine, Table V, Practice engagement sequence (continued)

| <i>Table V, Practice, Engagements 11 through 14, Kneeling, Supported</i> | | | |
|--|--------------------|---------------|----------------------|
| <i>Engagement</i> | <i>Target Type</i> | <i>Range</i> | <i>Exposure Time</i> |
| 11 | E-type | 50 m LEFT | 12 sec |
| | E-type | 100 m | |
| | E-type | 200 m | |
| 12 | F-type | 50 m RIGHT | 5 sec |
| | E-type | 200 m | |
| 13 | E-type | 150 m | 5 sec |
| | E-type | 250 m | |
| 14 | E-type | 100 m | 12 sec |
| | E-type | 150 m | |
| | E-type | 200 m | |
| Kneeling, Supported, Time per Firing Order Total | | | 48 sec |
| Note: There is a 2-second delay between all engagements. An 8-second delay time is incorporated at the end of engagement 14 to facilitate magazine and firing position changes. | | | |
| Legend: m – meters; sec – seconds | | | |

Table E-38. Rifle and Carbine, Table V, Practice engagement sequence (continued)

| <i>Table V, Practice, Engagements 15 through 18, Standing, Supported</i> | | | |
|--|--------------------|---------------|----------------------|
| <i>Engagement</i> | <i>Target Type</i> | <i>Range</i> | <i>Exposure Time</i> |
| 15 | E-type | 50 m LEFT | 5 sec |
| | E-type | 100 m | |
| 16 | E-type | 200 m | 5 sec |
| | E-type | 250 m | |
| 17 | F-type | 50 m RIGHT | 12 sec |
| | E-type | 100 m | |
| | E-type | 150 m | |
| 18 | E-type | 100 m | 12 sec |
| | E-type | 200 m | |
| | E-type | 250 m | |
| Standing, Supported, Time per Firing Order Total | | | 40 sec |
| Note: There is a 2-second delay between all engagements. | | | |
| Legend: m – meters; sec – seconds | | | |

E-62. Table E-39 provides the Table V, Practice, throughput schedule. Units use this table as a guide. The table portrays the overall efficiency of the range facility when conducting the training event. The table provides the overall throughput timetable based on the time the unit requires to remove one firing order from the firing positions and move the next firing order forward.

E-63. Three general movement schedules are available to assist firing order placements on the range, 2 minutes, 5 minutes, and 10 minutes. The more proficient a unit is at operating a small arms range facility, the greater the firer throughput on the facility. This schedule does not include time required for retraining, refire, or firers who have persistent problems using a reticle.

Table E-39. Rifle and Carbine, Table V, Practice, throughput time schedule

| <i>Phase</i> | <i>Time to Execute</i> | <i>Remarks</i> | | | |
|--|---|---|---------------|--|----------------|
| Prone, Unsupported | 0:56 seconds | Includes 2-seconds between engagements and 8-seconds transition to next phase. | | | |
| Prone, Supported | 0:46 seconds | | | | |
| Kneeling, Supported | 0:48 seconds | | | | |
| Standing, Supported | 0:40 seconds | Includes 2-seconds between engagements. | | | |
| Total Time Per Firing Order | 3:10 minutes | Does not include administrative time to move firing order to or from their respective firing positions. | | | |
| <i>Total Number of Firing Orders</i> | <i>Table V Execution with Administration Time Between Firing Orders</i> | | | <i>Total Firer Throughput based on Range Configuration</i> | |
| | <i>2 min</i> | <i>5 min</i> | <i>10 min</i> | <i>16 Lane</i> | <i>32 Lane</i> |
| 2 | 11 min | 17 min | 27 min | 32 | 64 |
| 3 | 16 min | 25 min | 40 min | 48 | 96 |
| 4 | 21 min | 33 min | 53 min | 64 | 128 |
| 5 | 26 min | 41 min | 1 hr 6 min | 80 | 160 |
| 6 | 32 min | 50 min | 1 hr 20 min | 96 | 192 |
| 7 | 37 min | 58 min | 1 hr 33 min | 112 | 224 |
| 8 | 42 min | 1 hr 6 min | 1 hr 46 min | 128 | 256 |
| 9 | 47 min | 1 hr 14 min | 1 hr 59 min | 144 | 288 |
| 10 | 53 min | 1 hr 23 min | 2 hrs 13 min | 160 | 320 |
| 11 | 58 min | 1 hr 31 min | 2 hrs 26 min | 176 | 352 |
| 12 | 1 hr 3 min | 1 hr 39 min | 2 hrs 39 min | 192 | 384 |
| 13 | 1 hr 8 min | 1 hr 47 min | 2 hrs 52 min | 208 | 416 |
| 14 | 1 hr 14 min | 1 hr 56 min | 3 hrs 6 min | 224 | 448 |
| 15 | 1 hr 19 min | 2 hrs 4 min | 3 hrs 19 min | 240 | 480 |
| 16 | 1 hr 24 min | 2 hrs 12 min | 3 hrs 32 min | 256 | 512 |
| 17 | 1 hr 29 min | 2 hrs 20 min | 3 hrs 45 min | 272 | 544 |
| 18 | 1 hr 35 min | 2 hrs 29 min | 3 hrs 59 min | 288 | 576 |
| 19 | 1 hr 40 min | 2 hrs 37 min | 4 hrs 12 min | 304 | 608 |
| 20 | 1 hr 45 min | 2 hrs 45 min | 4 hrs 25 min | 320 | 640 |
| Legend: hr – hour; hrs – hours, min – minutes | | | | | |

CONDUCT OF THE RANGE

E-64. Leaders instruct Soldiers on the objectives of the tasks in Table V and the importance of the functional elements of the shot process. Table V contains 18 firing tasks with an administrative pause programmed at the end of each phase to facilitate emergency reloading and changing positions.

E-65. Soldiers enter the range and move to their firing points. Once at the firing point, firers assume a standing firing position with rifle and carbines in a green status. Firers fire Table V from the ready at varying firing positions throughout the duration of the course of fire, where—

- Tasks 1 through 5 are fired from the prone, unsupported firing position.
- Tasks 6 through 10 are fired from the prone, supported firing position.
- Tasks 11 through 14 are fired from the kneeling, supported firing position.
- Tasks 15 through 18 are fired from the standing, supported firing position.

E-66. Firers must hit a minimum of 28 of the 40 targets presented (70 percent) to successfully pass the event. It is not required for Soldiers to complete this table successfully before conducting Table VI tasks. This event is purposefully more rigorous than the qualification event where the targets are presented in a rapid tempo, and the time to transition between firing positions and tactical reloading are reduced. This practice event induces periodic weapon malfunctions using DDI munitions into the firers’ magazines in a random fashion. The leader annotates the official record of training on DA Form 7801.

E-67. Soldiers begin Table V training by moving into the firing position following administrative commands from the tower operator. The tower operator uses administrative commands to control the flow of the range, movement of personnel, and other command and control purposes. Table E-40 is an example of the administrative commands for moving a new firing order into position.

Table E-40. Table V, new firing order, conduct of the range example

| <i>New Firing Order, Conduct of the Range</i> | | | |
|--|---|---|-----------------------|
| PRACTICE | Task | Target | Target Type |
| | New Firing Order | N/A | N/A |
| | Rounds per Target | DODIC | Time (Seconds) |
| | N/A | AB57 AB46 | NO LIMIT |
| TOWER | | SOLDIER ACTION | |
| CONDUCT OF THE RANGE | SECURE YOUR AMMUNITION AND MOVE TO YOUR FIRING POINT | Soldiers secure their weapon in a GREEN status, their training ammunition in four magazines, and move to the designated firing point. | |
| Once all firers are complete, conduct of the range continues. | | | |
| Legend: DODIC – Department of Defense identification code, N/A – not applicable | | | |

E-68. If the unit cannot complete the zero confirmation task during Table IV training, the unit must provide one each, five-round magazine to each firer. The firing order conducts the confirm zero at distance task prior to beginning Table V tasks. This may be done sequentially (recommended) or the unit may conduct all required zero confirmations prior to initiating Table V training.

E-69. Units can use table E-41 to complete the confirmation at distance task. Firers must have one five-round magazine to conduct the event. Firers are in a green status at their assigned firing point.

Table E-41. Table IV, engagement 7, confirmation at distance, conduct of fire example

| <i>Table IV, Engagement 7 – Zero Confirmation at Distance</i> | | | |
|---|--|--|---------------------------------|
|  <p>300 meter (Unit may select different zero range based on their SOP, TTP, or mission requirements).</p> | Zero | Target | Target Type |
| | 1 | E-1 or D-1 | Silhouette, kneeling (bob-mode) |
| | Rounds per Engagement | DODIC | Time (Seconds) |
| | 5 | AB57 | NO LIMIT |
| TOWER | SOLDIER ACTION | | |
| WEAPONS SAFETY STATUS RED | GO TO PRONE MAKE READY | Soldier moves to the PRONE supported position, establishes a good firing position, and loads one five-round magazine. | |
| ALERT | FIRERS | | |
| TARGET DESCRIPTION | TROOP | Soldier acquires the zero confirmation target. | |
| DIRECTION | FRONT | | |
| RANGE | THREE-HUNDRED | Soldier acquires the target and identifies the target's center of visible mass (known as CoVM). | |
| CONTROL | FIVE ROUNDS SLOW FIRE WEAPONS FREE WEAPONS FREE | | |
| EXECUTION | ENGAGE UPON POSITIVE IDENTIFICATION | Soldier begins slow firing a five-round shot group, ensuring the same point of aim for each round. | |
| ONCE ALL FIRERS ARE COMPLETE WITH THE FIVE-ROUND CONFIRMATION AT DISTANCE: | | | |
| TERMINATION | CEASE FIRE CEASE FIRE | The firer's BOLT should be locked to the rear. Tower must assume all weapons are RED. | |
| WEAPONS SAFETY STATUS GREEN | GO GREEN SHOW CLEAR | Soldiers clear their weapons, show clear to the lane safety. | |
| Firer's should achieve four of five hits at distance to successfully complete confirmation at distance. The tower should identify any firer that has not met the confirmation standard and move those Soldiers to retraining location. | | | |
| Legend: DODIC – Department of Defense identification code, SOP – standard operating procedure, TTP – tactics, techniques, and procedures | | | |

E-70. Once all firers have completed stage 3, they remain in place and await further instructions from the tower operator. The tower operator instructs them to reload and prepare for stage 4. Table E-42 shows the conduct of fire example for Table IV, stage 4.

Table E-42. Table IV, engagement 8, application of hold-offs, conduct of fire example

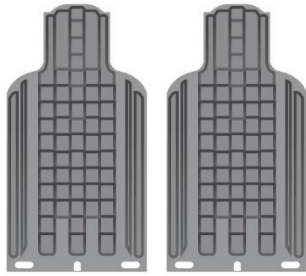
| <i>Table IV, Engagement 8 – Application of Hold-Offs</i> | | | |
|--|--|---|---------------------------------|
|  <p>100 and 200 meter</p> | Stage | Target | Target Type |
| | 4 | E-1 or D-1 | Silhouette, kneeling (bob-mode) |
| | Rounds per Engagement | DODIC | Time (Seconds) |
| 10 | AB57 | 55 | |
| TOWER | | SOLDIER ACTION | |
| WEAPONS SAFETY STATUS RED | MAKE READY | Soldier remains in the PRONE supported position, establishes a good firing position, and loads one 10-round magazine. | |
| ALERT | FIRERS | | |
| TARGET DESCRIPTION | TROOPS | Soldier acquires the 100 meter target. | |
| DIRECTION | FRONT | | |
| RANGE | ONE-HUNDRED AND TWO HUNDRED | Soldier acquires the target and identifies the target's center of visible mass (known as CoVM). | |
| CONTROL | FIVE ROUNDS SLOW FIRE WEAPONS FREE WEAPONS FREE | | |
| EXECUTION | ENGAGE UPON POSITIVE IDENTIFICATION | Soldier begins slow firing a five-round shot group, applying the appropriate hold-off at the 100 meter target and again at the 200 meter target. | |
| ONCE ALL FIRERS ARE COMPLETE WITH THE 10-ROUND APPLICATION OF HOLD-OFFS | | | |
| TERMINATION | CEASE FIRE CEASE FIRE | The firer's BOLT should be locked to the rear. Tower must assume all weapons are RED. | |
| WEAPONS SAFETY STATUS GREEN | GO GREEN SHOW CLEAR | Soldiers clear their weapons, show clear to the lane safety. | |
| Firer's should achieve four of five hits at distance to successfully complete application of hold-offs. The tower should identify any firer that has not met the standard and move those Soldiers to retraining location. | | | |
| Legend: DODIC – Department of Defense identification code, SOP – standard operating procedure, TTP – tactics, techniques, and procedures | | | |

E-71. The following engagement sequence guide initiates the Table V tasks scenario. Tables E-43 through E-46, on pages E-65 through E-68, are the engagement sequences with a generic conduct of fire process for the tower operator.

Table E-43. Table V, engagement 1 through 5, conduct of fire example

| Engagement 1 through 5 – Day, Prone, Unsupported | | | |
|---|--------------------------|--|-----------------------|
| | Engagement | Target | Target Type |
| | 1 through 5 | E-1 F-1 | Point |
| | Rounds | DODIC | Time (Seconds) |
| | 1 magazine 11 rounds* | AB57 (10) AB46 (1)* | 56 |
| TOWER | | SOLDIER ACTION | |
| WEAPONS SAFETY STATUS RED | | MAKE READY | |
| ALERT | | CONTACT | |
| TARGET DESCRIPTION | | TROOPS | |
| DIRECTION | | FRONT | |
| RANGE | | MID-RANGE | |
| METHOD | | NEAR TO FAR | |
| CONTROL | | WEAPONS FREE WEAPONS FREE | |
| EXECUTION | | ENGAGE UPON POSITIVE IDENTIFICATION | |
| Soldier moves the weapon from SAFE to FIRE, and begins the target acquisition process. | | | |
| Soldier engages the first target from the STANDING UNSUPPORTED firing position then goes to the PRONE UNSUPPORTED firing position. Soldier acquires, prioritizes, and engages targets with one round per target. | | | |
| TOWER AWAITS COMPLETION OF ENGAGEMENT 5 THEN PROCEEDS IMMEDIATELY | | | |
| WEAPONS SAFETY STATUS REMAINS RED | | | |
| <p>Note: There is a 5-second delay between the first and second engagement to allow the Soldier to go to prone. There is a 2-second delay between all other engagements in this table. There is an 8-second delay at the end of the phase to support changing the magazine and changing the firing position.</p> <p>* DDI is randomly placed in one of the four magazines.</p> | | | |
| <p>Legend: DDI – drilled, dummy, inert, DODIC – Department of Defense identification code, m – meter</p> | | | |

Table E-44 Table V, engagement 6 through 10, conduct of fire example

| <i>Engagement 6 through 10 – Day, Prone, Supported</i> | | | |
|--|---|--|-----------------------|
| | Engagement | Target | Target Type |
| | 6 through 10 | E-1 | Point |
| | Rounds | DODIC | Time (Seconds) |
| | 1 magazine, 11 rounds* | AB57 (10) AB46 (1)* | 46 |
| TOWER | | SOLDIER ACTION | |
| WEAPONS SAFETY STATUS RED | <i>Although the firer's bolt should be locked to the rear, the tower must treat all weapons as if in a RED status</i> | Soldier remains in the PRONE position, at the READY and may RELOAD or await instructions. | |
| CONTROL | GO TO PRONE SUPPORTED RELOAD | The Soldier conducts an emergency RELOAD and establishes a PRONE, SUPPORTED position and prepares to engage. | |
| TOWER AWAITS THE END OF THE 8-SECOND TRANSITION THEN PROCEEDS | | | |
| WEAPONS SAFETY STATUS REMAINS RED | | | |
| EXECUTION | ENGAGE UPON POSITIVE IDENTIFICATION | Soldier acquires, prioritizes, and engages targets with one round per target. | |
| TOWER AWAITS COMPLETION OF ENGAGEMENT 10 THEN PROCEEDS IMMEDIATELY | | | |
| WEAPONS SAFETY STATUS REMAINS RED | | | |
| <p>Note: There is a 2-second delay between all engagements. There is an 8-second delay at the end of the phase to support changing the magazine and changing the firing position. * DDI is randomly placed in one of the four magazines.</p> | | | |
| <p>Legend: DDI - drilled, dummy, inert, DODIC – Department of Defense identification code, m – meter</p> | | | |

Table E-45. Table V, engagement 11 through 14, conduct of fire example

| <i>Engagement 11 through 14 – Kneeling, Supported</i> | | | |
|--|--|--|---|
| | Engagement | Target | Target Type |
| | 11 through 14 | E-1 F-1 | Point |
| | Rounds | DODIC | Time (Seconds) |
| | 1 magazine, 11 rounds* | AB57 (10) AB46 (1)* | 48 |
| TOWER | | SOLDIER ACTION | |
| WEAPONS SAFETY STATUS RED | <i>Although the firer's bolt should be locked to the rear, the tower must treat all weapons as if in a RED status.</i> | | Soldier remains at the READY and may RELOAD or await instructions. |
| CONTROL | RELOAD FIGHT UP | The Soldier conducts an emergency RELOAD and assumes the KNEELING, SUPPORTED position. | |
| TOWER AWAITS THE END OF THE 8-SECOND TRANSITION THEN PROCEEDS | | | |
| WEAPONS SAFETY STATUS REMAINS RED | | | |
| EXECUTION | ENGAGE UPON POSITIVE IDENTIFICATION | Soldier acquires, prioritizes, and engages targets with one round per target. | |
| TOWER AWAITS COMPLETION OF ENGAGEMENT 14 THEN PROCEEDS | | | |
| WEAPONS SAFETY STATUS REMAINS RED | | | |
| <p>Note: There is a 2-second delay between all engagements. There is an 8-second delay at the end of the phase to support changing the magazine and changing the firing position. * DDI is randomly placed in one of the four magazines.</p> | | | |
| <p>Legend: DDI – drilled, dummy, inert, DODIC – Department of Defense identification code, m – meter</p> | | | |

Table E-46. Table V, engagement 15 through 18, conduct of fire example

| <i>Engagement 15 through 18 – Standing, Supported</i> | | | |
|---|--|--|---|
| | Engagement | Target | Target Type |
| | 15 through 18 | E-1 F-1 | Point |
| | Rounds | DODIC | Time (Seconds) |
| | 1 magazine, 11 rounds* | AB57 (10) AB46 (1)* | 40 |
| TOWER | | SOLDIER ACTION | |
| WEAPONS SAFETY STATUS RED | <i>Although the firer's bolt should be locked to the rear, the tower must treat all weapons as if in a RED status.</i> | | Soldier remains at the READY and may RELOAD or await instructions. |
| CONTROL | RELOAD FIGHT UP | The Soldier conducts an emergency RELOAD and assumes the STANDING, SUPPORTED position. | |
| TOWER AWAITS THE END OF THE 8-SECOND TRANSITION THEN PROCEEDS | | | |
| WEAPONS SAFETY STATUS REMAINS RED | | | |
| EXECUTION | ENGAGE UPON POSITIVE IDENTIFICATION | Soldier acquires, prioritizes, and engages targets with one round per target. | |
| TOWER AWAITS COMPLETION OF ENGAGEMENT 18 THEN PROCEEDS | | | |
| WEAPONS SAFETY STATUS REMAINS RED | | | |
| <p>Note: There is a 2-second delay between all engagements. This completes the day firing phase for Table V training. There are no alibis authorized. Any remaining ammunition is returned to the ammunition issue point for redistribution. * DDI is randomly placed in one of the four magazines.</p> | | | |
| <p>Legend: DDI – drilled, dummy, inert, DODIC – Department of Defense identification code, m – meter</p> | | | |

E-72. A lane safety clears the firers upon their completion of Table V and collecting their dunnage. A lane safety verifies the clearing prior to the Soldiers moving from their firing point. Once the lane safety clears all Soldiers, the lane safety communicates the WSS to the tower operator and the tower operator issues an administrative command to move the completed Soldiers off the range. Table E-47 has an example of this command, also.

Table E-47. Table V, completed firing order, conduct of the range example

| Firing Order Complete | | | |
|---|--|--|----------------|
| FIRING ORDER COMPLETE | Task | Target | Target Type |
| | Completed Firing Order | N/A | N/A |
| | Rounds per Target | DODIC | Time (Seconds) |
| | N/A | N/A | NO LIMIT |
| TOWER | | SOLDIER ACTION | |
| TOWER MUST ASSUME ALL FIRERS' WEAPON SAFETY STATUS IS RED | | | |
| TERMINATION | CEASE FIRE CEASE FIRE | Soldiers stop firing and place weapons on SAFE. | |
| WEAPONS SAFETY STATUS GREEN | GO GREEN GO GREEN ONCE VERIFIED BY THE RSO, SECURE WEAPON | Soldiers clear their weapon and wait to be inspected by a lane safety. | |
| CONDUCT OF THE RANGE | FIRERS SECURE YOUR DUNNAGE MOVE TO THE BASELINE. | Firers secure weapon, DDI, and ammunition dunnage and move to the designated location. | |
| Once all firers return to the baseline, tower directs the firing order off the range. | | | |
| Legend: DDI – drilled, dummy, inert, DODIC – Department of Defense identification code, N/A – not applicable, RSO – range safety officer | | | |

E-73. As soon as the lane safety clears the completed firing order, the tower operator moves a new firing order into position and the process repeats itself until all firers have successfully completed Table V, Practice event. The tower operator moves all identified firers who require retraining to the appropriate concurrent training location.

RIFLE AND CARBINE, TABLE VI, QUALIFICATION

E-74. Leaders use Table VI, Qualification, demonstrate the firer’s proficiency at common engagement and tactical skills. Table VI tasks challenge firers with single and multiple stationary targets between 50 and 300 meters from the prone unsupported, prone supported, kneeling supported, and standing supported firing positions. Table VI tasks evaluate the firer’s ability to engage single and multiple targets placed in a tactical array using their primary optic and applying the functional elements of the shot process. In a timed scenario, the firer demonstrates target prioritization and weapons manipulation. Table VI occurs on an ARF or comparable range facility.

TASK, CONDITIONS, AND STANDARD

E-75. Table E-48 outlines the task, conditions, and standard for the conduct of Table VI tasks. The firer conducting the event should know the task, conditions, and standards and should explain them during the conduct of the range briefing.

Table E-48. Rifle and Carbine, Table VI, Qualification task, conditions, and standard

| | |
|---|--|
| Task: | Engage and defeat single and multiple threats at varying ranges from supported and unsupported standing, kneeling, and prone firing positions, during day and limited visibility conditions using ball ammunition. |
| Conditions: | <p>Given the following:</p> <ul style="list-style-type: none"> • Fully mission capable weapon as assigned on the master authorization list for the unit. • Full combat uniform, issued equipment, and protective mask. • Authorized range facility. • Authorized simulator system (Day Fire, CBRN; Night Fire and Night Fire, CBRN). • Full-scale, approved targetry in standard scenario engagement sequences. • Authorized ammunition. |
| Standard: | <p>Demonstrate engagement proficiency by stage, such that:</p> <ul style="list-style-type: none"> • Stage 1 – Day Fire – hit 57.5 percent (23 of 40) of all presented targets in the time allotted. • Stage 2 – Day Fire, CBRN – receive a GO by successfully hitting 70-percent (7 of 10) of targets presented while operating in a notional chemical environment. • Stage 3 – Night Fire – receive a GO by successfully hitting 70-percent (14 of 20) of targets presented during limited visibility conditions. • Stage 4 – Night Fire, CBRN – receive a GO by successfully hitting 70-percent (7 of 10) of targets presented while operating in a notional chemical environment. |
| <p>Note. Units supported by an authorized simulation system conduct Day Fire, CBRN (Stage 2), Night Fire (Stage 3), and Night Fire, CBRN (Stage 4) portions of Table VI in their simulated system.</p> <p>Units that do not have an assigned authorized simulator system complete stage 2 through 4, live, under live-fire conditions, at the end of Stage 1, Day, Unlimited Visibility.</p> | |
| <p>Legend: CBRN – chemical, biological, radiological, and nuclear</p> | |

E-76. Table E-49 shows the training event design template for Rifle and Carbine, Table VI, Qualification. Units conduct this event on an authorized live-fire facility, typically an ARF or comparable range facility. See TC 25-8 for additional information on authorized range facilities.

Table E-49. Training event design template for Rifle and Carbine, Table VI, Qualification

| <i>Rifle and Carbine, Table VI, Qualification Live-Fire Proficiency Gate</i> | | | | | | | |
|--|---------------|------------------------|-------------------------|---------------------------------------|--------------------------|---------------------------------|-------------|
| EVENT NAME: | QUALIFICATION | ENVIRONMENT: | | LIVE | 1.0 | | |
| WEAPON: | M4 / M16 | CONDITIONS: | | LIVE FIRE | | | |
| CATEGORY: | FOUNDATION | PRIMARY FACILITY: | | ARF | DAYS REQUIRED | | |
| PUBLICATION: | TC 3-22.9 | ALTERNATE FACILITY: | | QTR | | | |
| REQUIRED: | YES | COMPONENT: | AC | RC | 120 SOLDIERS | | |
| RECORD: | DA Form 7801 | FREQUENCY: | 2 | 1 | | | |
| VALID FOR: | 12 MONTHS | ANNUAL DAYS TOTAL: | 2 | 1 | THROUGHPUT | | |
| TABLE | | | | | | | |
| | | I | II | III | IV | V | VI |
| | | PMI&E | PLFS | DRILLS | BASIC | PRACTICE | QUAL |
| | | PRQ | PRQ | PRQ | | | REQUIRED |
| WHEN EXECUTED: | | | | | | | T-X |
| CONDEMNATION CRITERIA (CC) | RULE 1 | RULE 2 | RULE 3 | RULE 4 | RULE 5 | RULE 6 | |
| | TIME | KEY LEADER TURNOVER | COMMANDER ASSESSMENT | SUBORDINATE ELEMENT PROFICIENCY | SPECIALTY PROFICIENCY | STAFF SECTION PROFICIENCY | |
| <p>Remarks: Each Soldier assigned an individual weapon <i>must</i> successfully complete Table VI, Qualification tasks to meet their live-fire proficiency gate. The live-fire proficiency gate is required for any Soldier to participate in <i>any collective live-fire event</i>.</p> | | | | | | | |
| <p>Note: Table III tasks should be used as concurrent training on Tables IV, V, and VI while Soldiers are awaiting training in a firing order or between day and night phases.</p> | | | | | | | |
| <p>Legend: AC – active component (known as active duty), ARF – automated record fire range, DA – Department of the Army, PLFS – preliminary live-fire simulation, PMI&E – preliminary marksmanship instruction and evaluation, PRQ – prerequisite, QTR – qualification training range, QUAL – qualification, RC – Reserve Component (known as Reserves), TC – training circular, T-X – training event exercise,</p> | | | | | | | |

E-77. Due to the varying training environments required for Soldiers to demonstrate proficiency with their weapons, this course of fire is conducted in stages. Units that have access to an approved simulations system complete stage 2, stage 3, and stage 4 in that system. Only units without access to an approved simulator system receive the training ammunition to conduct all stages as live-fire scenarios during qualification. The stages are conditions based as described in table E-50.

Table E-50. Stage descriptions, Rifle and Carbine, Table VI, Qualification

| Stage | Conditions | Virtual | Live | Remarks |
|--|-------------------|----------------|-------------|--|
| Stage 1 | Day Fire | N/A | P | All Soldiers complete stage 1 live under live-fire conditions. |
| Stage 2 | Day Fire, CBRN | P | A | Completed after stage 1. |
| Stage 3 | Night Fire | P | A | Completed after stage 2. |
| Stage 4 | Night Fire, CBRN | P | A | Completed after stage 3. |
| Note: No firer may use virtual systems to complete Stage 1, Rifle and Carbine, Table VI, Qualification. | | | | |
| Legend: A – authorized only when no approved simulator system is available to the unit, CBRN – chemical, biological, radiological, and nuclear, P – primary method of execution, NA – not applicable. | | | | |

AMMUNITION

E-78. All Soldiers assigned a rifle or carbine on a unit MAL must complete Rifle and Carbine, Table VI, Qualification training. Soldiers conduct this event to demonstrate their proficiency to employ a rifle or carbine against mid-range threats.

E-79. To effectively plan and forecast for sufficient training ammunition, the unit uses the ammunition requirements listed in table E-51. Units identify the total number of firers and should plan for unscheduled firers and necessary retraining by increasing their forecasted training as appropriate.

Table E-51. Rifle and Carbine, Table VI, Qualification ammunition requirements

| Stage | Event | DODIC | Nomenclature | QTY | Remarks |
|---|--------------------------|-------|----------------------------------|-----|---|
| Table IV, Stage 3 | Confirmation at Distance | AB57 | CTG, 5.56mm, ball, M855A1 EPR | 5 | Conducted prior to Table VI on the ARF or comparable facility when range restrictions or line-of-sight issues prevent completion of the task during Table IV. |
| Table IV, Stage 4 | Application of Hold-Offs | AB57 | CTG, 5.56mm, ball, M855A1 EPR | 10 | Conducted prior to Table VI on the ARF or comparable facility when range restrictions or line-of-sight issues prevent completion of the task during Table IV. |
| Note. Table IV, Stages 3 and 4 must be completed before Table VI, Stage 1. | | | | | |
| Stage 1 | Day Fire | AB57 | CTG, 5.56mm, ball, M855A1 EPR | 40 | One round per target is required. |
| Stage 2 | Day Fire, CBRN | AB57 | CTG, 5.56mm, ball, M855A1 EPR | 10 | When authorized simulator system is available, no rounds are authorized. One round per target is required when live fire authorized. |
| Stage 3 | Night Fire | AB57 | CTG, 5.56mm, ball, M855A1 EPR | 10 | |
| | | AB74 | CTG, 5.56mm, tracer, M856A1, EPR | 10 | |
| Stage 4 | Night Fire, CBRN | AB57 | CTG, 5.56mm, ball, M855A1 EPR | 5 | |
| | | AB74 | CTG, 5.56mm, tracer, M856A1, EPR | 5 | |
| Legend: ARF – automated record fire range, CBRN – chemical, biological, radiological, and nuclear, CTG – cartridge, DODIC – Department of Defense identification code, EPR – enhanced performance round, mm – millimeter; QTY – quantity | | | | | |

E-80. Table VI is an automated timed event of four, live-fire phases. Leaders issue ammunition to every firer as shown in table E-52, on page E-74, to conduct the event to standard. Firers place these magazines in their magazine pouches. Staging or pre-positioning magazines is not authorized for the conduct of Table VI training.

Table E-52. Rifle and Carbine, Table VI, Qualification ammunition breakdown

| <i>Stage</i> | <i>Event</i> | <i>Phase</i> | <i>Sequence Magazine</i> | <i>AB57 5.56mm Ball</i> | <i>AB74 5.56mm Tracer</i> | <i>Magazine Total Rounds</i> |
|---|-------------------------|-----------------------|--------------------------|-------------------------|---------------------------|------------------------------|
| Stage 1 | Day Fire | Prone, unsupported | 1 | 10 each | | 10 rounds |
| | | Prone, supported | 2 | 10 each | | 10 rounds |
| | | Kneeling, supported | 3 | 10 each | | 10 rounds |
| | | Standing, supported | 4 | 10 each | | 10 rounds |
| Stage 2 | Day Fire, CBRN | Standing, unsupported | 5 | 10 each | | 10 rounds |
| Stage 3 | Night Fire | Kneeling, supported | 1 | 5 each | 5 each | 10 rounds |
| | | Standing, supported | 2 | 5 each | 5 each | 10 rounds |
| Stage 4 | Night Fire, CBRN | Standing, unsupported | 3 | 5 each | 5 each | 10 rounds |
| <p>Note: The DDI rounds may not be used during stage 1, day fire, of Table VI, Qualification.</p> <p>Stages 2, 3, and 4 are conducted live under live-fire conditions only when authorized (an approved simulator system is unavailable.)</p> <p>Legend: CBRN – chemical, biological, radiological, and nuclear; DDI – dummy, drilled, inert; mm – millimeter</p> | | | | | | |

RANGE FACILITIES

E-81. Table E-53 shows the Army-standard range facilities specifically designed to support the tasks listed in Rifle and Carbine, Table VI, Qualification. Units must refer to their installation's range operations SOPs or local training regulation to identify the weapon-specific range facilities. Units will use their RFMSS system for all scheduling.

Table E-53. Rifle and Carbine, Table VI, Qualification authorized range facilities

| <i>Table VI</i> | <i>Targetry</i> | <i>Range Facility</i> | |
|--|---|-----------------------|------------|
| | | <i>ARF</i> | <i>QTR</i> |
| Qualification | E-type, E1, target, silhouette: plastic, polyethylene, kneeling (NSN: 6920-00-071-4780) F-type, F-1, target, silhouette: plastic, polyethylene, prone (NSN 6920-00-071-4589) | P | A |
| | D-type, D1, target, silhouette: plastic, mannequin, kneeling (NSN 6920-01-164-9625) D-type, D-2, target, 3-Dimensional: plastic, mannequin, prone (NSN 6920-01-387-6397) | P | A |
| Legend: A – alternate, ARF- automated record fire range, NSN – national stock number, P – primary, QTR – qualification training range | | | |

TARGETRY

E-82. Table VI tasks require silhouette targetry, either E-type, F-type, or D-type targets on the range. The leader must confirm the type and capability of the range’s targetry, lifting mechanisms, simulators, and identify any unit requirements. During the preparation phase, leaders should be familiar with the targetry and the sequence of the firing events. Figure E-22 shows the authorized targetry used with Table VI.





| | |
|--|--|
| <p align="center">E-1 Target, silhouette: plastic, polyethylene, kneeling NSN 6920-00-071-4780</p> | <p align="center">D-1 Target, 3-dimensional: plastic, mannequin, kneeling NSN 6920-01-164-9625</p> |
|  |  |
| <p align="center">F-1 Target, silhouette: plastic, polyethylene, prone NSN 6920-00-071-4589</p> | <p align="center">D-2 Target, 3-dimensional: plastic, mannequin, prone NSN 6920-01-387-6397</p> |
|  <p align="center">Prone targets are used only on the 50-meter RIGHT emplacement.</p> |  <p align="center">Prone targets are used only on the 50-meter RIGHT emplacement.</p> |
| <p>Notes:</p> <p>Use of E-1 or D-1 kneeling targets is at the discretion of the installation. Both represent dismounted, kneeling Infantry targets on small arms and maneuver facilities.</p> <p>Use F-1 or D-2 on the right 50-meter target emplacement only.</p> <p>Use of G-2 prone targets is not authorized.</p> | |
| <p>Legend: NSN – national stock number</p> | |

Figure E-22. Table VI, authorized target types

STAGE 1 – DAY FIRE

E-83. Stage 1, Day Fire is a required event as part of rifle and carbine qualification. (See table E-53.) Leaders use stage 1 to evaluate the firer's ability to engage targets at varying ranges from common firing positions. At a minimum, Soldiers are required to fire this course of fire while wearing individual combat equipment. All Soldiers assigned a rifle and carbine must complete this course of fire as part of their qualification.

AMMUNITION

E-84. To effectively plan and forecast for sufficient training ammunition, the unit uses the ammunition requirements listed in table E-54 and table E-55. Units need to identify the total number of firers and should plan for unscheduled firers and necessary retraining by increasing their forecasted training ammunition, as appropriate.

Table E-54. Stage 1, Day Fire, ammunition requirements

| <i>Stage 1</i> | <i>DODIC</i> | <i>Nomenclature</i> | <i>Quantity</i> | <i>Remarks</i> |
|----------------|--------------|-------------------------------|-----------------|--|
| Day Fire | AB57 | CTG, 5.56mm, BALL, M855A1 EPR | 40 | 1 round is authorized for each target presented. |

Legend: CTG – cartridge, DODIC – Department of Defense identification code, EPR – enhanced performance round, mm – millimeter

Table E-55. Rifle and Carbine, Table VI, Qualification, Stage 1, Day Fire, ammunition breakdown

| <i>Stage 1</i> | <i>Phase</i> | <i>Sequence Magazine</i> | <i>AB57 5.56mm Ball</i> | <i>Magazine Total Rounds</i> |
|----------------|---------------------|--------------------------|-------------------------|------------------------------|
| Day Fire | Prone, unsupported | 1 | 10 each | 10 rounds |
| | Prone, supported | 2 | 10 each | 10 rounds |
| | Kneeling, supported | 3 | 10 each | 10 rounds |
| | Standing, supported | 4 | 10 each | 10 rounds |

Legend: mm – millimeter

SCENARIO ENGAGEMENTS

E-85. Targets are presented to the firer in single and multiple target arrays. Targets are presented such that 90 percent of the target is clearly visible to the firer from the expected or planned firing position. Targets are exposed to the firer based on the number of targets presented during the engagement as follows:

- Single target engagements are exposed for 5-seconds.
- Double target engagements are exposed for 8-seconds.
- Triple target engagements are exposed for 12-seconds.
- Quadruple target engagements are exposed for 16-seconds.

E-86. There is a 3-second delay between each engagement. After each phase (prone unsupported, prone supported, kneeling supported, and standing supported), there is a 10-second transition delay providing the firer time to conduct an emergency reload and assume the next specified position. Table E-56 shows the scenario engagement sequence for Table VI.

Table E-56. Rifle and Carbine Table VI, Qualification, Stage 1, Day Fire, engagement sequence

| <i>Table VI, Qualification, Engagements 1 through 5, React to Contact, Transition to Prone, Unsupported</i> | | | |
|---|--------------------|---------------|----------------------|
| Engagement | Target Type | Range | Exposure Time |
| 1 | F-type | 50 m RIGHT | 5 sec |
| 2 | E-type | 100 m | 5 sec |
| 3 | E-type | 150 m | 5 sec |
| 4 | E-type | 50 m LEFT | 12 sec |
| | E-type | 150 m | |
| | E-type | 200 m | |
| 5 | E-type | 150 m | 16 sec |
| | E-type | 200 m | |
| | E-type | 250 m | |
| | E-type | 300 m | |
| Prone, Unsupported, Time per Firing Order Total | | | 67 sec |
| <p>Note: There is a 5-second delay between the first and second engagement to allow the Soldier to go to prone. There is a 3-second delay between all other engagements in this table. A 10-second delay time is incorporated at the end of engagement 5 to facilitate reload and firing position changes.</p> | | | |
| <p>Legend: m – meters; sec – seconds</p> | | | |

Table E-56. Rifle and Carbine, Table VI, Qualification, Stage 1, Day Fire, engagement sequence (continued)

| <i>Table VI, Qualification, Engagements 6 through 10, Prone, Supported</i> | | | |
|--|--------------------|--------------|----------------------|
| <i>Engagement</i> | <i>Target Type</i> | <i>Range</i> | <i>Exposure Time</i> |
| 6 | E-type | 100 m | 5 sec |
| 7 | E-type | 150 m | 8 sec |
| | E-type | 300 m | |
| 8 | E-type | 200 m | 8 sec |
| | E-type | 300 m | |
| 9 | E-type | 250 m | 8 sec |
| | E-type | 300 m | |
| 10 | E-type | 150 m | 12 sec |
| | E-type | 250 m | |
| | E-type | 300 m | |
| Prone, Supported, Time per Firing Order Total | | | 63 sec |
| Note: There is a 3-second delay between all engagements. A 10-second delay time is incorporated at the end of engagement 10 to facilitate reload and firing position changes. | | | |
| Legend: m – meters; sec – seconds | | | |

Table E-56. Rifle and Carbine, Table VI, Qualification, engagement sequence (continued)

| <i>Table VI, Qualification, Engagements 11 through 14, Kneeling, Supported</i> | | | |
|---|--------------------|---------------|----------------------|
| <i>Engagement</i> | <i>Target Type</i> | <i>Range</i> | <i>Exposure Time</i> |
| 11 | E-type | 50 m LEFT | 12 sec |
| | E-type | 100 m | |
| | E-type | 200 m | |
| 12 | F-type | 50 m RIGHT | 8 sec |
| | E-type | 200 m | |
| 13 | E-type | 150 m | 8 sec |
| | E-type | 250 m | |
| 14 | E-type | 100 m | 12 sec |
| | E-type | 150 m | |
| | E-type | 200 m | |
| Kneeling, Supported, Time per Firing Order Total | | | 59 sec |
| <p>Note: There is a 3-second delay between all engagements. A 10-second delay time is incorporated at the end of engagement 14 to facilitate reload and firing position changes.</p> | | | |
| <p>Legend: m – meters; sec – seconds</p> | | | |

Table E-56. Rifle and Carbine, Table VI, Qualification, engagement sequence (continued)

| <i>Table VI, Qualification, Engagements 15 through 18, Standing, Supported</i> | | | |
|--|--------------------|---------------|----------------------|
| Engagement | Target Type | Range | Exposure Time |
| 15 | E-type | 50 m LEFT | 8 sec |
| | E-type | 100 m | |
| 16 | E-type | 200 m | 8 sec |
| | E-type | 250 m | |
| 17 | F-type | 50 m RIGHT | 12 sec |
| | E-type | 100 m | |
| | E-type | 150 m | |
| 18 | E-type | 100 m | 12 sec |
| | E-type | 200 m | |
| | E-type | 250 m | |
| Standing, Supported, Time per Firing Order Total | | | 49 sec |
| Note: There is a 3-second delay between all engagements. | | | |
| Legend: m – meters; sec – seconds | | | |

E-87. Units use throughput schedules as a guide to portray the overall efficiency of the range facility when conducting the training event. The throughput schedule provides the overall throughput timetable, based on the time the unit requires to remove one firing order from the firing positions and move the next firing order forward. Table E-57, on page E-82, provides the Table VI, Qualification, Stage 1, Day Fire throughput schedule. Table E-58, on page E-83, provides the throughput schedule for completing stage 1 and stage 2 events sequentially.

E-88. Three general movement schedules are available to assist firing order placements on the range, 2 minutes, 5 minutes, and 10 minutes. The more proficient a unit is at operating a small arms range facility, the greater the firer throughput on the facility. This schedule does not include time required for retraining, refires, or firers who have persistent problems using a reticle.

Table E-57. Stage 1, Day Fire, throughput time schedule

| <i>Phase</i> | <i>Time to Execute</i> | | <i>Remarks</i> | | |
|--|--|--------------|--|--|----------------|
| Prone, Unsupported | 1:07 minute | | Includes a 5 second delay between the first and second engagement and 3 seconds between all other engagements with 10 seconds transition between phases. | | |
| Prone, Supported | 1:03 minute | | | | |
| Kneeling, Supported | 0:59 seconds | | | | |
| Standing, Supported | 0:49 seconds | | Includes 3 seconds between engagements. | | |
| Total Time Per Firing Order | 3:58 minutes | | Does not include administrative time to move firing order to or from their respective firing positions. | | |
| <i>Total Number of Firing Orders</i> | <i>Table VI Execution with Administration Time Between Firing Orders</i> | | | <i>Total Firer Throughput based on Range Configuration</i> | |
| | <i>2 min</i> | <i>5 min</i> | <i>10 min</i> | <i>16 Lane</i> | <i>32 Lane</i> |
| 2 | 12 min | 18 min | 28 min | 32 | 64 |
| 3 | 18 min | 27 min | 42 min | 48 | 96 |
| 4 | 24 min | 36 min | 56 min | 64 | 128 |
| 5 | 30 min | 45 min | 1 hr 10 min | 80 | 160 |
| 6 | 36 min | 54 min | 1 hr 24 min | 96 | 192 |
| 7 | 42 min | 1 hr 3 min | 1 hr 38 min | 112 | 224 |
| 8 | 48 min | 1 hr 12 min | 1 hr 52 min | 128 | 256 |
| 9 | 54 min | 1 hr 21 min | 2 hrs 6 min | 144 | 288 |
| 10 | 60 min | 1 hr 30 min | 2 hrs 20 min | 160 | 320 |
| 11 | 1 hr 6 min | 1 hr 39 min | 2 hrs 34 min | 176 | 352 |
| 12 | 1 hr 12 min | 1 hr 48 min | 2 hrs 48 min | 192 | 384 |
| 13 | 1 hr 18 min | 1 hr 57 min | 3 hrs 2 min | 208 | 416 |
| 14 | 1 hr 24 min | 2 hrs 6 min | 3 hrs 16 min | 224 | 448 |
| 15 | 1 hr 30 min | 2 hrs 15 min | 3 hrs 30 min | 240 | 480 |
| 16 | 1 hr 35 min | 2 hrs 23 min | 3 hrs 43 min | 256 | 512 |
| 17 | 1 hr 41 min | 2 hrs 32 min | 3 hrs 57 min | 272 | 544 |
| 18 | 1 hr 47 min | 2 hrs 41 min | 4 hrs 11 min | 288 | 576 |
| 19 | 1 hr 53 min | 2 hrs 50 min | 4 hrs 25 min | 304 | 608 |
| 20 | 1 hr 59 min | 2 hrs 59 min | 4 hrs 39 min | 320 | 640 |
| Legend: hr – hour; hrs – hours, min – minutes | | | | | |

Table E-58. Stage 1, Day Fire, and Stage 2, Day Fire, Chemical, Biological, Radiological, and Nuclear throughput time schedule

| <i>Phase</i> | <i>Time to Execute</i> | | | <i>Remarks</i> | |
|--|--|--------------|---------------|---|----------------|
| Stage 1 Day Fire | 3:58 minutes | | | Includes 3 seconds between engagements and 10 seconds transition to next phase. | |
| Stage 2 Day Fire, CBRN Standing, unsupported | 2:02 minutes | | | Includes 1 minute transition to chemical protective posture and magazine change. | |
| Total time per firing order | 6:00 minutes | | | Does not include administrative time to move firing order to or from their respective firing positions. | |
| <i>Total Number of Firing Orders</i> | <i>Table VI Execution with Administration Time Between Firing Orders</i> | | | <i>Total Firer Throughput based on Range Configuration</i> | |
| | <i>2 min</i> | <i>5 min</i> | <i>10 min</i> | <i>16 Lane</i> | <i>32 Lane</i> |
| 2 | 16 min | 22 min | 32 min | 32 | 64 |
| 3 | 25 min | 34 min | 49 min | 48 | 96 |
| 4 | 33 min | 45 min | 1 hr 5 min | 64 | 128 |
| 5 | 41 min | 56 min | 1 hr 21 min | 80 | 160 |
| 6 | 49 min | 1 hr 7 min | 1 hr 37 min | 96 | 192 |
| 7 | 57 min | 1 hr 18 min | 1 hr 53 min | 112 | 224 |
| 8 | 1 hr 5 min | 1 hr 29 min | 2 hrs 9 min | 128 | 256 |
| 9 | 1 hr 14 min | 1 hr 41 min | 2 hrs 26 min | 144 | 288 |
| 10 | 1 hr 22 min | 1 hr 52 min | 2 hrs 42 min | 160 | 320 |
| 11 | 1 hr 30 min | 2 hrs 3 min | 2 hrs 58 min | 176 | 352 |
| 12 | 1 hr 38 min | 2 hrs 14 min | 3 hrs 14 min | 192 | 384 |
| 13 | 1 hr 46 min | 2 hrs 25 min | 3 hrs 30 min | 208 | 416 |
| 14 | 1 hr 54 min | 2 hrs 36 min | 3 hrs 46 min | 224 | 448 |
| 15 | 2 hrs 3 min | 2 hrs 48 min | 4 hrs 3 min | 240 | 480 |
| 16 | 2 hrs 11 min | 2 hrs 59 min | 4 hrs 19 min | 256 | 512 |
| 17 | 2 hrs 19 min | 3 hrs 10 min | 4 hrs 35 min | 272 | 544 |
| 18 | 2 hrs 27 min | 3 hrs 21 min | 4 hrs 51 min | 288 | 576 |
| 19 | 2 hrs 35 min | 3 hrs 32 min | 5 hrs 7 min | 304 | 608 |
| 20 | 2 hrs 43 min | 3 hrs 43 min | 5 hrs 23 min | 320 | 640 |
| Legend: CBRN – chemical, biological, radiological, and nuclear, hr – hour; hrs – hours, min – minutes | | | | | |

CONDUCT OF THE RANGE

E-89. Leaders instruct Soldiers on the objectives of Table VI tasks and the importance of the functional elements of the shot process. Table VI contains 18 firing tasks with an administrative pause programmed at the end of each phase to facilitate emergency reloading and changing positions.

E-90. Soldiers enter the range and move to their firing points. Once at the firing point, firers assume a standing firing position with rifle and carbines in a green status. Soldiers fire Table VI tasks from the ready at varying firing positions throughout the duration of the course of fires in the following manner:

- Tasks 1 through 5 are fired from the prone, unsupported firing position.
- Tasks 6 through 10 are fired from the prone, supported firing position.
- Tasks 11 through 14 are fired from the kneeling, supported firing position.
- Tasks 15 through 18 are fired from the standing, supported firing position.

E-91. Firers must hit a minimum of 23 of the 40 targets presented (57.5 percent) to successfully pass the event. All firers must also complete Table VI, Qualification, CBRN and Table VI, Qualification, Night tasks either in simulation (primary) or during live-fire (when authorized simulator systems are unavailable) as part of their overall rifle or carbine qualification. Leaders annotate the official record on DA Form 7801.

E-92. Soldiers begin Table VI tasks by moving into the firing position following administrative commands from the tower operator. The tower operator uses administrative commands to control the flow of the range, movement of personnel, and other command and control purposes. Table E-59 illustrates the administrative commands for moving a new firing order into position.

Table E-59. Table VI, new firing order, conduct of the range example

| <i>New Firing Order, Conduct of the Range</i> | | | |
|--|---|---|-----------------------|
| PRACTICE | Task | Target | Target Type |
| | New Firing Order | N/A | N/A |
| | Rounds per Target | DODIC | Time (Seconds) |
| | N/A | AB57 | NO LIMIT |
| TOWER | SOLDIER ACTION | | |
| CONDUCT OF THE RANGE | SECURE YOUR AMMUNITION AND MOVE TO YOUR FIRING POINT | Soldiers secure their weapon in a GREEN status, their training ammunition in four magazines, and move to the designated firing point. | |
| Once all firers are complete, conduct of the range continues. | | | |
| Legend: DODIC – Department of Defense identification code, N/A – not applicable | | | |

E-93. If the unit cannot complete the zero confirmation task during Table IV training, the unit must provide one five-round magazine to each firer. The firing order conducts the confirm zero at distance task prior to beginning Table VI tasks. This may be done sequentially (recommended), or the unit may conduct all required zero confirmations prior to initiating Table VI.

E-94. Units can use the following guide (table E-60) to complete the confirmation at distance task. Firers must have one five-round magazine to conduct the event. Firers are in a green status at their assigned firing point.

Table E-60. Table IV, engagement 7, confirmation at distance, conduct of fire example

| <i>Table IV, Engagement 7 – Zero Confirmation at Distance</i> | | | |
|---|--|---|---------------------------------------|
|  <p>300 meter (Unit may select different zero range based on their SOP, TTP, or mission requirements).</p> | Zero | Target | Target Type |
| | 1 | E-1 or D-1 | Silhouette, kneeling (bob-mode) |
| | Rounds per Engagement | DODIC | Time (Seconds) |
| | 5 | AB57 | NO LIMIT |
| TOWER | | SOLDIER ACTION | |
| WEAPONS SAFETY STATUS RED | GO TO PRONE MAKE READY | Soldier moves to the PRONE supported position, establishes a good firing position and loads one five-round magazine. | |
| ALERT | FIRERS | | |
| TARGET DESCRIPTION | TROOP | Soldier acquires the zero confirmation target. | |
| DIRECTION | FRONT | | |
| RANGE | THREE-HUNDRED | Soldier acquires the target and identifies the target's center of visible mass (known as CoVM). | |
| CONTROL | FIVE ROUNDS SLOW FIRE WEAPONS FREE WEAPONS FREE | | |
| EXECUTION | ENGAGE UPON POSITIVE IDENTIFICATION | Soldier begins slow firing a five-round shot group, ensuring the same point of aim for each round. | |
| ONCE ALL FIRERS ARE COMPLETE WITH THE FIVE-ROUND CONFIRMATION AT DISTANCE: | | | |
| TERMINATION | CEASE FIRE CEASE FIRE | The firer's BOLT should be locked to the rear. Tower must assume all weapons are RED. | |
| WEAPONS SAFETY STATUS GREEN | GO GREEN SHOW CLEAR | Soldiers clear their weapons, show clear to the lane safety. | |
| Firer's should achieve four of five hits at distance to successfully complete confirmation at distance. The tower should identify any firer that has not met the confirmation standard and move those Soldiers to retraining location. | | | |
| Legend: DODIC – Department of Defense identification code, SOP – standard operating procedure, TTP – tactics, techniques, and procedures | | | |

E-95. Once all firers have completed stage 3, they remain in place and await further instructions from the tower operator. The tower operator instructs them to reload and prepare for stage 4. Table E-41 shows a conduct of fire example for Table IV, Stage 4 training. Table E-61 shows an example of the conduct of fire for Table IV, Stage 4.

Table E-61. Table IV, engagement 8, application of hold-offs, conduct of fire example

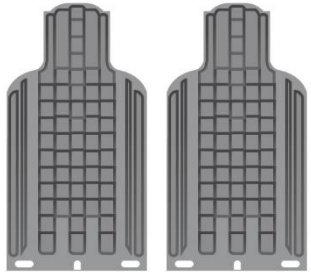
| <i>Table IV, Engagement 8 – Application of Hold-Offs</i> | | | |
|--|--|--|---------------------------------|
|  <p>100 and 200 meter</p> | Stage | Target | Target Type |
| | 4 | E-1 or D-1 | Silhouette, kneeling (bob-mode) |
| | Rounds per Engagement | DODIC | Time (Seconds) |
| | 10 | AB57 | 55 |
| TOWER | | SOLDIER ACTION | |
| WEAPONS SAFETY STATUS RED | MAKE READY | Soldier remains in the PRONE supported position, establishes a good firing position, and loads one 10-round magazine. | |
| ALERT | FIRERS | | |
| TARGET DESCRIPTION | TROOPS | Soldier acquires the 100 meter target. | |
| DIRECTION | FRONT | | |
| RANGE | ONE-HUNDRED AND TWO HUNDRED | Soldier acquires the target and identifies the target's center of visible mass (known as CoVM). | |
| CONTROL | FIVE ROUNDS SLOW FIRE WEAPONS FREE WEAPONS FREE | | |
| EXECUTION | ENGAGE UPON POSITIVE IDENTIFICATION | Soldier begins slow firing a five-round shot group, applying the appropriate hold-off at the 100 meter target and again at the 200 meter target. | |
| ONCE ALL FIRERS ARE COMPLETE WITH THE 10-ROUND APPLICATION OF HOLD-OFFS | | | |
| TERMINATION | CEASE FIRE CEASE FIRE | The firer's BOLT should be locked to the rear. Tower must assume all weapons are RED. | |
| WEAPONS SAFETY STATUS GREEN | GO GREEN SHOW CLEAR | Soldiers clear their weapons, show clear to the lane safety. | |
| Firer's should achieve four of five hits at distance to successfully complete application of hold-offs. The tower should identify any firer that has not met the standard and move those Soldiers to retraining location. | | | |
| Legend: DODIC – Department of Defense identification code, SOP – standard operating procedure, TTP – tactics, techniques, and procedures | | | |

E-96. The following engagement sequence guide initiates the Table VI scenario. Tables E-62 through E-65, on pages E-87 through E-90, provide the engagement sequence with a generic conduct of fire process for the tower operator.

Table E-62. Table VI, engagement 1 through 5, conduct of fire example

| <i>Engagement 1 through 5 – Day, Prone, Unsupported</i> | | | |
|---|-------------------------|-------------------------------------|-----------------------|
| | Engagement | Target | Target Type |
| | 1 through 5 | E-1 F-1 | Point |
| | Rounds | DODIC | Time (Seconds) |
| | 1 magazine 10 rounds | AB57 | 67 |
| TOWER | | SOLDIER ACTION | |
| WEAPONS SAFETY STATUS RED | | MAKE READY | |
| ALERT | | FIRERS | |
| TARGET DESCRIPTION | | TROOPS | |
| DIRECTION | | FRONT | |
| RANGE | | MID-RANGE | |
| METHOD | | NEAR TO FAR | |
| CONTROL | | WEAPONS FREE WEAPONS FREE | |
| EXECUTION | | ENGAGE UPON POSITIVE IDENTIFICATION | |
| Soldier assumes a STANDING UNSUPPORTED firing position and loads one 10-round magazine. | | | |
| Soldier moves the weapon from SAFE to FIRE, and begins the target acquisition process. | | | |
| Soldier engages the first target from the STANDING UNSUPPORTED firing position then goes to the PRONE UNSUPPORTED firing position. Soldier acquires, prioritizes, and engages targets with one round per target. | | | |
| TOWER AWAITS COMPLETION OF ENGAGEMENT 5 THEN PROCEEDS IMMEDIATELY | | | |
| WEAPONS SAFETY STATUS REMAINS RED | | | |
| <p>Note: There is a 5-second delay between the first and second engagement to allow the Soldier to go to prone. There is a 3-second delay between all other engagements in this table. There is a 10-second delay at the end of the phase to support changing the magazine and changing the firing position.</p> | | | |
| <p>Legend: DODIC – Department of Defense identification code</p> | | | |

Table E-63. Table VI, engagement 6 through 10, conduct of fire example

| <i>Engagement 6 through 10 – Day, Prone, Supported</i> | | | |
|---|---|--|-----------------------|
| | Engagement | Target | Target Type |
| | 6 through 10 | E-1 | Point |
| | Rounds | DODIC | Time (Seconds) |
| | 1 magazine, 10 rounds | AB57 | 63 |
| TOWER | | SOLDIER ACTION | |
| WEAPONS SAFETY STATUS RED | <i>Although the firer's bolt should be locked to the rear, the tower must treat all weapons as if in a RED status</i> | Soldier remains in the PRONE position, at the READY and may RELOAD or await instructions. | |
| CONTROL | GO TO PRONE SUPPORTED RELOAD | The Soldier conducts an emergency RELOAD and establishes a PRONE, SUPPORTED position and prepares to engage. | |
| TOWER AWAITS THE END OF THE 10-SECOND TRANSITION THEN PROCEEDS | | | |
| WEAPONS SAFETY STATUS REMAINS RED | | | |
| EXECUTION | ENGAGE UPON POSITIVE IDENTIFICATION | Soldier acquires, prioritizes, and engages targets with one round per target. | |
| TOWER AWAITS COMPLETION OF ENGAGEMENT 10 THEN PROCEEDS IMMEDIATELY | | | |
| WEAPONS SAFETY STATUS REMAINS RED | | | |
| Note: There is a 3-second delay between all engagements. There is a 10-second delay at the end of the phase to support changing the magazine and changing the firing position. | | | |
| Legend: DODIC – Department of Defense identification code | | | |

Table E-64. Table VI, engagement 11 through 14, conduct of fire example

| <i>Engagement 11 through 14 – Kneeling, Supported</i> | | | |
|---|--|--|-----------------------|
| | Engagement | Target | Target Type |
| | 11 through 14 | E-1 F-1 | Point |
| | Rounds | DODIC | Time (Seconds) |
| | 1 magazine, 10 rounds | AB57 | 59 |
| TOWER | | SOLDIER ACTION | |
| WEAPONS SAFETY STATUS RED | <i>Although the firer's bolt should be locked to the rear, the tower must treat all weapons as if in a RED status.</i> | Soldier remains at the READY and may RELOAD or await instructions. | |
| CONTROL | RELOAD FIGHT UP | The Soldier conducts an emergency RELOAD and assumes the KNEELING, SUPPORTED position. | |
| TOWER AWAITS THE END OF THE 10-SECOND TRANSITION THEN PROCEEDS | | | |
| WEAPONS SAFETY STATUS REMAINS RED | | | |
| EXECUTION | ENGAGE UPON POSITIVE IDENTIFICATION | Soldier acquires, prioritizes, and engages targets with one round per target. | |
| TOWER AWAITS COMPLETION OF ENGAGEMENT 14 THEN PROCEEDS | | | |
| WEAPONS SAFETY STATUS REMAINS RED | | | |
| Note: There is a 3-second delay between all engagements. There is a 10-second delay at the end of the phase to support changing the magazine and changing the firing position. | | | |
| Legend: DODIC – Department of Defense identification code | | | |

Table E-65. Table VI, engagement 15 through 18, conduct of fire example

| <i>Engagement 15 through 18 – Standing, Supported</i> | | | |
|--|--|--|---|
| | Engagement | Target | Target Type |
| | 15 through 18 | E-1 F-1 | Point |
| | Rounds | DODIC | Time (Seconds) |
| | 1 magazine, 10 rounds | AB57 | 49 |
| TOWER | | SOLDIER ACTION | |
| WEAPONS SAFETY STATUS RED | <i>Although the firer's bolt should be locked to the rear, the tower must treat all weapons as if in a RED status.</i> | | Soldier remains at the READY and may RELOAD or await instructions. |
| CONTROL | RELOAD FIGHT UP | The Soldier conducts an emergency RELOAD and assumes the STANDING, SUPPORTED position. | |
| TOWER AWAITS THE END OF THE 10-SECOND TRANSITION THEN PROCEEDS | | | |
| WEAPONS SAFETY STATUS REMAINS RED | | | |
| EXECUTION | ENGAGE UPON POSITIVE IDENTIFICATION | Soldier acquires, prioritizes, and engages targets with one round per target. | |
| TOWER AWAITS COMPLETION OF ENGAGEMENT 18 THEN PROCEEDS | | | |
| WEAPONS SAFETY STATUS REMAINS RED | | | |
| <p>Note: There is a 3-second delay between all engagements. This completes the day firing phase for Table VI. <i>There are no alibis authorized.</i> Any remaining ammunition is returned to the ammunition issue point for redistribution.</p> | | | |
| <p>Legend: DODIC – Department of Defense identification code</p> | | | |

E-97. A lane safety clears the firers upon their completion of Table VI tasks and collecting their dunnage. A lane safety verifies the clearing prior to the Soldiers moving from their firing point. Once the lane safety clears all Soldiers, the lane safety communicates the WSS to the tower operator and the tower operator issues an administrative command to move the completed Soldiers off the range. Table E-66 is an example of this command.

Table E-66. Table VI, completed firing order, conduct of the range example

| <i>Firing Order Complete</i> | | | |
|--|--|--|----------------|
| FIRING ORDER COMPLETE | Task | Target | Target Type |
| | Completed Firing Order | N/A | N/A |
| | Rounds per Target | DODIC | Time (Seconds) |
| | N/A | N/A | NO LIMIT |
| TOWER | | SOLDIER ACTION | |
| TOWER MUST ASSUME ALL FIRERS' WEAPON SAFETY STATUS ARE RED | | | |
| TERMINATION | CEASE FIRE CEASE FIRE | Soldiers stop firing and place weapons on SAFE. | |
| WEAPONS SAFETY STATUS GREEN | GO GREEN GO GREEN ONCE VERIFIED BY THE RSO, SECURE WEAPON | Soldiers clear their weapon and wait to be inspected by a lane safety. | |
| CONDUCT OF THE RANGE | FIRERS SECURE YOUR DUNNAGE MOVE TO THE BASELINE. | Firers secure weapon and ammunition dunnage and move to the designated location. | |
| Once all firers return to the baseline, tower directs the firing order off the range. | | | |
| Legend: DODIC – Department of Defense identification code, N/A – not applicable, RSO – range safety officer | | | |

E-98. As soon as the completed firing order is clear, a new firing order can be moved into position and the process is repeated until all firers have successfully completed Table VI, Qualification. Any identified firers who require retraining are moved to the appropriate concurrent training location.

STAGE 2 – DAY FIRE, CHEMICAL, BIOLOGICAL, RADIOLOGICAL, AND NUCLEAR

E-99. Stage 2, Day Fire, CBRN is a required event as part of rifle and carbine qualification. It is designed to train and evaluate the firer’s ability to engage targets while operating with individual chemical protective equipment. At a minimum, Soldiers are required to fire this course of fire while wearing individual combat equipment and a protective mask with hood. All Soldiers assigned a rifle or carbine must complete this course of fire as part of their qualification based on their access to primary simulations systems (See table E-67, on page E-92.)

Table E-67. Stage 2, Day Fire, Chemical, Biological, Radiological, and Nuclear, training environment requirement

| <i>Supported / Available System</i> | <i>Authorized As</i> | <i>Qualification Environment Required</i> | |
|---|----------------------|---|-------------------------|
| | | <i>Virtual</i> | <i>Live (Live-Fire)</i> |
| Soldier and squad virtual training system (S / SVT) | Primary | X | |
| Engagement skills trainer (EST) | Alternate | X | |
| None available | Live-Fire | | X |

E-100. All firers that have access to an authorized primary or alternate simulation system are not authorized training ammunition to conduct this event in a live environment under live-fire conditions. Units that have secured resources may use the live-fire CBRN qualification for record.

E-101. Stage 2 is only for units that do not have access to an authorized simulator system based on the system’s basis of issue plan. Failure to coordinate for the appropriate system or failure to conduct the CBRN qualification in a designated and authorized system does not authorize the use of training ammunition for this event.

AMMUNITION

E-102. To effectively plan and forecast for sufficient training ammunition, the unit will use the ammunition requirements listed in table E-68. Units need to identify the total number of firers and should plan for unscheduled firers and necessary retraining by increasing their forecasted training ammunition as appropriate. Firers place these magazines in their magazine pouches. Staging or pre-positioning magazines is not authorized for the conduct of Table VI, CBRN, Day tasks.

Table E-68. Stage 2, Day Fire, Chemical, Biological, Radiological, and Nuclear, ammunition requirements

| <i>Stage 2</i> | <i>DODIC</i> | <i>Nomenclature</i> | <i>Quantity</i> | <i>Remarks</i> |
|--|--------------|-------------------------------|-----------------|--|
| Day Fire, CBRN | AB57 | CTG, 5.56mm, ball, M855A1 EPR | 10 | One round is authorized for each target presented. |
| Legend: CBRN – chemical, biological, radiological, and nuclear, CTG – cartridge, DODIC – Department of Defense identification code, EPR – enhanced performance round, mm – millimeter | | | | |

SCENARIO ENGAGEMENTS

E-103. Targets are presented to the firer in single and multiple target arrays. Targets are presented such that 90-percent of the target is clearly visible to the firer from the expected or planned firing position. Targets are exposed to the firer based on the number of targets presented during the engagement as follows:

- Single target engagements are exposed for 5 seconds.
- Double target engagements are exposed for 8 seconds.

E-104. There is a 3-second delay during day fire between each engagement. Table E-69 shows the scenario engagement sequence for CBRN qualification. The leader annotates the official record of training on DA Form 7801.

Table E-69. Stage 2, Day Fire, Chemical, Biological, Radiological, and Nuclear, target engagement sequence

| <i>Stage 2, Day Fire, CBRN, Standing, Unsupported</i> | | | |
|---|--------------------|---------------|----------------------|
| <i>Engagement</i> | <i>Target Type</i> | <i>Range</i> | <i>Exposure Time</i> |
| 1 | F-type | 50 m RIGHT | 5 sec |
| 2 | E-type | 100 m | 8 sec |
| | E-type | 50 m LEFT | |
| 3 | F-type | 50 m RIGHT | 8 sec |
| | E-type | 150 m | |
| 4 | E-type | 200 m | 5 sec |
| 5 | E-type | 100 m | 5 sec |
| 6 | E-type | 150 m | 5 sec |
| 7 | F-type | 50 m RIGHT | 8 sec |
| | E-type | 50 m LEFT | |
| Standing, Unsupported, Time per Firing Order Total | | | 62 sec |
| Note: There is a 3 second delay between all engagements. | | | |
| Legend: CBRN – chemical, biological, radiological, and nuclear; m – meters; sec – seconds | | | |

E-105. Table E-70, on page E-94, provides the stage 2, day fire, CBRN throughput schedule. Table E-69 is a guide for units. The table portrays the overall efficiency of the range facility when conducting the training event. Table E-70 provides the overall throughput timetable based on the time the unit requires to remove one firing order from the firing positions and move the next firing order forward.

E-106. Three general movement schedules are available to administer firing order placements on the range, 2 minutes, 5 minutes, and 10 minutes. The more proficient a unit is at operating a small arms range facility, the greater the firer throughput on the facility. This schedule does not include time required for retraining, refires, or firers who have persistent problems using a reticle.

Table E-70. Stage 2, Day Fire, Chemical, Biological, Radiological, and Nuclear throughput time schedule



| Stage | | Time to Execute | | | Remarks | |
|--|--|------------------------|---------------|--|---|--|
| Stage 2, Day, CBRN, standing, unsupported | | 1:02 minute | | | Includes 3 seconds between engagements. | |
| Total Time Per Firing Order | | 1:02 minute | | | Does not include administrative time to move firing order to or from their respective firing positions. | |
| Total Number of Firing Orders | Table VI Execution With Administration Time Between Firing Orders | | | Total Firer Throughput Based on Range Configuration | | |
| | 2 min | 5 min | 10 min | 16 Lane | 32 Lane | |
| 2 | 6 min | 12 min | 22 min | 32 | 64 | |
| 3 | 10 min | 19 min | 34 min | 48 | 96 | |
| 4 | 13 min | 25 min | 45 min | 64 | 128 | |
| 5 | 16 min | 31 min | 56 min | 80 | 160 | |
| 6 | 19 min | 37 min | 1 hr 7 min | 96 | 192 | |
| 7 | 22 min | 43 min | 1 hr 18 min | 112 | 224 | |
| 8 | 26 min | 50 min | 1 hr 30 min | 128 | 256 | |
| 9 | 29 min | 56 min | 1 hr 41 min | 144 | 288 | |
| 10 | 32 min | 1 hr 2 min | 1 hr 52 min | 160 | 320 | |
| 11 | 35 min | 1 hr 8 min | 2 hrs 3 min | 176 | 352 | |
| 12 | 38 min | 1 hr 14 min | 2 hrs 14 min | 192 | 384 | |
| 13 | 42 min | 1 hr 21 min | 2 hrs 26 min | 208 | 416 | |
| 14 | 45 min | 1 hr 27 min | 2 hrs 37 min | 224 | 448 | |
| 15 | 48 min | 1 hr 33 min | 2 hrs 48 min | 240 | 480 | |
| 16 | 51 min | 1 hr 39 min | 2 hrs 59 min | 256 | 512 | |
| 17 | 54 min | 1 hr 45 min | 3 hrs 10 min | 272 | 544 | |
| 18 | 58 min | 1 hr 52 min | 3 hrs 22 min | 288 | 576 | |
| 19 | 1 hr 1 min | 1 hr 58 min | 3 hrs 33 min | 304 | 608 | |
| 20 | 1 hr 4 min | 2 hrs 4 min | 3 hrs 44 min | 320 | 640 | |
| Legend: CBRN – chemical, biological, radiological, and nuclear, hr – hour; hrs – hours, min – minutes | | | | | | |

CONDUCT OF THE RANGE

E-107. Leaders instruct Soldiers on the objectives of day fire, CBRN and the importance of the functional elements of the shot process. Units conduct the elements of Table VI, Qualification, Day Fire, CBRN in a single scenario, containing single and double threat presentations. Firers must hit a minimum of 7 of the 10 targets presented (70-percent) to successfully pass this table (receive a GO).

E-108. Soldiers begin day fire, CBRN by moving into the firing position following administrative commands from the tower operator. Soldiers enter the range and move to their firing points. Once at the firing point, firers assume a standing, unsupported firing position. Firers fire the tasks from the ready throughout the duration of the course of fire in Table VI, Qualification, Day Fire, CBRN. Table E-71 is an example of the administrative commands for moving a new firing order into position.

Table E-71. Stage 2, Day Fire, Chemical, Biological, Radiological, and Nuclear, new firing order, conduct of the range example

| <i>New Firing Order, Conduct of the Range</i> | | | | |
|--|------------|--|-------------|----------------|
|  CBRN | Engagement | Target | Target Type | |
| | | New Firing Order | N/A | N/A |
| | | Rounds per Target | DODIC | Time (Seconds) |
| | | N/A | AB57 | NO LIMIT |
| TOWER | | SOLDIER ACTION | | |
| CONDUCT OF THE RANGE FIRERS, SECURE YOUR WEAPON AND AMMUNITION ONCE COMPLETE, MOVE TO YOUR FIRING POINT | | Soldiers secure their weapon, ammunition, and chemical protective mask and move to the designated firing point. | | |
| ONCE FIRERS ARE SET AT THEIR FIRING POINT, THE TOWER CONTINUES. | | | | |
| CONDUCT OF THE RANGE FIRERS, CHEMICAL AGENTS HAVE BEEN REPORTED IN YOUR AREA GAS GAS GAS | |  Soldiers don their protective equipment. | | |
| ONCE ALL FIRERS HAVE COMPLETED DONNING PROTECTIVE GEAR, THE TOWER CONTINUES. | | | | |
| Legend: CBRN – chemical, biological, radiological, and nuclear, DODIC – Department of Defense identification code, N/A – not applicable | | | | |

E-109. Once the tower operator confirms all firers are at the appropriate firing point and in the proper MOPP level, the tower operator proceeds to the first engagement. Table VI, Qualification, CBRN, has ten engagements that use two, 10-round magazines. Table E-72 and Table E-73 on page E-97 provides the commands for tasks 1 through 7.

Table E-72. Stage 2, Day Fire, Chemical, Biological, Radiological, and Nuclear, conduct of fire

| <i>Stage 2, Day Fire, CBRN, Standing, Unsupported</i> | | | |
|--|--------------------------|---|-----------------------|
| | Engagement | Target | Target Type |
| | 1 to 7 | E-1 F-1 | Point |
| | Rounds per Target | DODIC | Time (Seconds) |
| | 1 | AB57 (10) | 62 |
| TOWER | | SOLDIER ACTION | |
| WEAPONS SAFETY STATUS RED | | FIRERS MAKE READY | |
| ALERT | | CONTACT | |
| TARGET DESCRIPTION | | | |
| DIRECTION | | MULTIPLE TROOPS | |
| RANGE | | FRONT | |
| METHOD | | MID-RANGE | |
| CONTROL | | NEAR TO FAR | |
| WEAPONS FREE WEAPONS FREE | | Soldier moves the weapon from SAFE to FIRE, and begins the target acquisition process. | |
| EXECUTION | | Soldier acquires targets, prioritizes targets, and engages targets with one round per target. | |
| ENGAGE WHEN POSITIVELY IDENTIFIED | | | |
| ONCE ALL FIRERS ARE COMPLETE, TOWER CONTINUES. | | | |
| WEAPONS SAFETY STATUS REMAINS RED | | | |
| Note: There is a 3-second delay between all engagements. | | | |
| Legend: CBRN – chemical, biological, radiological, and nuclear, DODIC – Department of Defense identification code | | | |

Table E-73. Stage 2, Day Fire, Chemical, Biological, Radiological, and Nuclear, completed firing order, conduct of the range example

| Completed Firing Order, Conduct of the Range | | | |
|--|--|--|-----------------------|
|  CBRN | Engagement | Target | Target Type |
| | Completed Firing Order | N/A | N/A |
| | Rounds per Target | DODIC | Time (Seconds) |
| | N/A | N/A | NO LIMIT |
| TOWER | SOLDIER ACTION | | |
| TOWER MUST ASSUME ALL FIRERS WEAPONS SAFETY STATUS IS RED | | | |
| TERMINATION | CEASE FIRE CEASE FIRE | Soldiers stop firing and place weapons on SAFE. | |
| WEAPONS SAFETY STATUS GREEN | GO GREEN GO GREEN | Soldiers clear their weapon and wait to be inspected by a lane safety. | |
| ONCE TOWER CONFIRMS ALL WEAPONS ARE GREEN AND CLEAR, TOWER CONTINUES | | | |
| CONDUCT OF THE RANGE | ALL CLEAR ALL CLEAR SECURE YOUR DUNNAGE MOVE TO THE ENTRY CONTROL POINT | Firers unmask, secure their weapon, ammunition, and dunnage. Once complete, they move to the range's entry control point. | |
| Tower waits for all Soldiers to reach the entry control point (ECP) prior to moving the next firing order into position. | | | |
| Legend: CBRN – chemical, biological, radiological, and nuclear, DODIC – Department of Defense identification code, N/A – not applicable | | | |

E-110. A lane safety clears the firers upon their completion of stage 2, day fire, CBRN and collecting their dunnage from the firing position. The RSO or lane safety verifies weapons cleared prior to the Soldier moving from their firing point. Once the lane safety clears all Soldiers, the lane safety communicates the green weapons safety status to the tower operator. The tower operator then issues an administrative command directing the completed Soldiers to move off the range.

STAGE 3 – NIGHT FIRE

E-111. Stage 3, Rifle and Carbine, Table VI, Qualification, Night Fire trains the firer to engage targets during periods of limited visibility while wearing night vision goggles. At a minimum, Soldiers are required to fire this course of fire while wearing individual combat equipment and their assigned night vision device. Targets are placed in a tactical array at close quarter's distances.

E-112. All Soldier's assigned a rifle or carbine must complete this course of fire as part of their qualification based on their access to primary simulations systems. (See table E-74, on page E-98.)

Table E-74. Rifle and Carbine, Table VI, Qualification, Night Fire, execution based on virtual system availability

| <i>Supported / Available System</i> | <i>Authorized As</i> | <i>Environment Training Conducted</i> | |
|---|----------------------|---------------------------------------|-------------------------|
| | | <i>Virtual</i> | <i>Live (Live-Fire)</i> |
| Soldier and squad virtual training system (S / SVT) | Primary | X | |
| Engagement skills trainer (EST) | Alternate | X | |
| None available | None | | X |

AMMUNITION

E-113. To effectively plan and forecast for sufficient training ammunition, the unit uses the ammunition requirements listed in tables E-75 and E-76. Units need to identify the total number of firers and should plan for unscheduled firers and necessary retraining by increasing their forecasted training ammunition as appropriate. Firers place these magazines in their magazine pouches. Staging or pre-positioning magazines is not authorized for the conduct of Table VI, Night Fire.

Table E-75. Rifle and Carbine, Table VI, Night Fire ammunition requirements

| <i>Training Event</i> | <i>DODIC</i> | <i>Nomenclature</i> | <i>Quantity</i> | <i>Remarks</i> |
|--|--------------|----------------------------------|-----------------|--|
| Qualification, Night Fire | AB57 | CTG, 5.56mm, ball, M855A1 EPR | 10 | One round is authorized for each target presented. |
| | AB74 | CTG, 5.56mm, tracer, M856A1, EPR | 10 | |
| Legend: CTG – cartridge, DODIC – Department of Defense identification code, EPR – enhanced performance round, mm – millimeter | | | | |

Table E-76. Rifle and Carbine, Table VI, Qualification, Night Fire, ammunition breakdown

| <i>Phase</i> | <i>Sequence / Magazine</i> | <i>AB57 5.56mm, Ball</i> | <i>AB74 5.56mm Tracer</i> | <i>Magazine Total Rounds</i> |
|--|----------------------------|--------------------------|---------------------------|------------------------------|
| Kneeling, supported | 1 | 5 each | 5 each | 10 rounds |
| Kneeling, supported | 2 | 5 each | 5 each | 10 rounds |
| Note: Both magazines contain 5 each AB57 and 5-each AB74 tracer rounds. | | | | |
| Legend: mm - millimeter | | | | |

SCENARIO ENGAGEMENTS

E-114. Targets are presented to the firer in single and multiple target arrays. Targets are presented such that 90 percent of the target is clearly visible to the firer from the expected or planned firing position. Targets are exposed to the firer based on the number of targets presented during the engagement as follows:

- Single target engagements are exposed for 8 seconds.
- Double target engagements are exposed for 12 seconds.
- Triple target engagements are exposed for 16 seconds.

E-115. There is a 5-second delay between each engagement. After the initial phase, there is a 15-second transition delay providing the firer with the time to conduct an emergency reload and make ready. Table E-77 shows the scenario engagement sequence for night fire qualification.

Table E-77. Stage 3, Night Fire, target engagement sequence

| <i>Rifle and Carbine, Table VI, Qualification, Stage 3, Night Fire, Kneeling, Supported</i> | | | |
|--|--------------------|---------------|----------------------|
| <i>Engagement</i> | <i>Target Type</i> | <i>Range</i> | <i>Exposure Time</i> |
| 1 | F-type | 50 m RIGHT | 8 sec |
| 2 | E-type | 50 m LEFT | 8 sec |
| 3 | F-type | 50 m RIGHT | 8 sec |
| 4 | E-type | 50 m LEFT | 12 sec |
| | E-type | 100 m | |
| 5 | E-type | 50 m LEFT | 12 sec |
| | E-type | 100 m | |
| 6 | F-type | 50 m RIGHT | 16 sec |
| | E-type | 50 m LEFT | |
| | E-type | 100 m | |
| Prone, Unsupported, Time per Firing Order Total | | | 104 seconds |
| Note: There is a 5-second delay between all engagements. A 15 second delay time is incorporated at the end of engagement 6 to facilitate magazine changes. | | | |
| Legend: m – meters; sec – seconds | | | |

Table E-77. Stage 3, Night Fire, target engagement sequence (continued)

| <i>Rifle and Carbine, Table VI, Qualification, Stage 3, Night Fire, Kneeling, Supported, continued</i> | | | |
|--|--------------------|---------------|----------------------|
| Engagement | Target Type | Range | Exposure Time |
| 7 | F-type | 50 m RIGHT | 12 sec |
| | E-type | 50 m LEFT | |
| 8 | E-type | 50 m LEFT | 12 sec |
| | E-type | 100 m | |
| 9 | F-type | 50 m RIGHT | 16 sec |
| | E-type | 50 m LEFT | |
| | E-type | 100 m | |
| 10 | F-type | 50 m RIGHT | 16 sec |
| | E-type | 50 m LEFT | |
| | E-type | 100 m | |
| Prone, Unsupported, Time per Firing Order Total | | | 71 seconds |
| Note: There is a 5-second delay between all engagements. | | | |
| Legend: m – meters; sec – seconds | | | |

E-116. Table E-78 is the Table VI, Qualification, Night Fire throughput schedule. Table E-78 is a guide for units. The table portrays the overall efficiency of the range facility when conducting the training event. Table E-78 provides the overall throughput timetable based on the time the unit requires to remove one firing order from the firing positions and move the next firing order forward.

E-117. Three general movement schedules are available to administer firing order placements on the range, 2 minutes, 5 minutes, and 10 minutes. The more proficient a unit is at operating a small arms range facility, the greater the firer throughput on the facility. The schedule does not include time required for retraining, refires, or firers who have persistent problems using a reticle.

Table E-78. Stage 3, Night Fire and Stage 4, Night Fire, Chemical, Biological, Radiological, and Nuclear throughput time schedule

| <i>Phase</i> | <i>Time to Execute</i> | | | <i>Remarks</i> | |
|---|--|--------------|---------------|---|----------------|
| Stage 3, Night Fire, kneeling, supported | 1:44 minute | | | Includes 5 seconds between engagements and 15 seconds transition to next phase. | |
| Stage 3, Night Fire, kneeling, supported | 1:11 minute | | | | |
| Stage 4, Night Fire, CBRN, standing, unsupported | 2:08 minute | | | Includes 1 minute transition to CBRN. | |
| Total Time Per Firing Order | 5:03 minutes | | | Does not include administrative time to move firing order to or from their respective firing positions. | |
| <i>Total Number of Firing Orders</i> | <i>Night Fire Execution With Administration Time Between Firing Orders</i> | | | <i>Total Firer Throughput Based on Range Configuration</i> | |
| | <i>2 min</i> | <i>5 min</i> | <i>10 min</i> | <i>16 Lane</i> | <i>32 Lane</i> |
| 2 | 14 min | 20 min | 30 min | 32 | 64 |
| 3 | 21 min | 30 min | 45 min | 48 | 96 |
| 4 | 28 min | 40 min | 1 hr 0 min | 64 | 128 |
| 5 | 35 min | 50 min | 1 hr 15 min | 80 | 160 |
| 6 | 42 min | 1 hr 0 min | 1 hr 30 min | 96 | 192 |
| 7 | 49 min | 1 hr 10 min | 1 hr 45 min | 112 | 224 |
| 8 | 56 min | 1 hr 20 min | 2 hrs 0 min | 128 | 256 |
| 9 | 1 hr 3 min | 1 hr 30 min | 2 hrs 15 min | 144 | 288 |
| 10 | 1 hr 11 min | 1 hr 41 min | 2 hrs 31 min | 160 | 320 |
| 11 | 1 hr 18 min | 1 hr 51 min | 2 hrs 46 min | 176 | 352 |
| 12 | 1 hr 25 min | 2 hrs 1 min | 3 hrs 1 min | 192 | 384 |
| 13 | 1 hr 32 min | 2 hrs 11 min | 3 hrs 16 min | 208 | 416 |
| 14 | 1 hr 39 min | 2 hrs 21 min | 3 hrs 31 min | 224 | 448 |
| 15 | 1 hr 46 min | 2 hrs 31 min | 3 hrs 46 min | 240 | 480 |
| 16 | 1 hr 53 min | 2 hrs 41 min | 4 hrs 1 min | 256 | 512 |
| 17 | 1 hr 60 min | 2 hrs 51 min | 4 hrs 16 min | 272 | 544 |
| 18 | 2 hrs 7 min | 3 hrs 1 min | 4 hrs 31 min | 288 | 576 |
| 19 | 2 hrs 14 min | 3 hrs 11 min | 4 hrs 46 min | 304 | 608 |
| 20 | 2 hrs 21 min | 3 hrs 21 min | 5 hrs 1 min | 320 | 640 |
| Note: This throughput schedule includes Stage 4, Night Fire, CBRN, for planning purposes to capture the full night fire requirement. | | | | | |
| Legend: CBRN – chemical, biological, radiological and nuclear; hr – hour; hrs – hours, min – minutes | | | | | |

CONDUCT OF THE RANGE

E-118. Leaders instruct Soldiers instructed on the objectives of stage 3, night fire and the importance of the functional elements of the shot process. Units conduct Table VI, Qualification, Stage 3, Night Fire tasks in two administrative and 10 firing tasks. Firers must hit a minimum of 14 of the 20 targets presented (70 percent) to successfully pass.

E-119. Soldiers begin Table VI, Night by moving into the firing position following administrative commands from the tower operator. Soldiers enter the range and move to their firing points. Once the Soldiers are at the firing point, they assume a standing firing position with rifles or carbines in a green status. Soldiers fire from the ready throughout the duration of the course of fire according to Table VI, Qualification, Night Fire tasks.

E-120. The tower operator uses administrative commands to control the flow of the range, movement of personnel, and other command and control purposes. Table E-79 provides an example of the administrative commands for moving a new firing order into position.

Table E-79. Stage 3, Night Fire, new firing order, conduct of the range example

| <i>New Firing Order, Conduct of the Range</i> | | | |
|--|---|---|-----------------------|
| NIGHT FIRE | Engagement | Target | Target Type |
| | New Firing Order | N/A | N/A |
| | Rounds per Target | DODIC | Time (Seconds) |
| | N/A | AB57 AB74 | NO LIMIT |
| TOWER | | SOLDIER ACTION | |
| FIRERS | | | |
| CONDUCT OF THE RANGE | SECURE YOUR WEAPON AND AMMUNITION | Soldiers secure their weapon, ammunition, and night vision equipment and move to the designated firing point. | |
| | ONCE COMPLETE MOVE TO YOUR FIRING POINT | | |
| ONCE ALL FIRERS ARE AT THEIR FIRING POSITIONS, THE TOWER CONTINUES. | | | |
| Legend: DODIC – Department of Defense identification code, N/A – not applicable | | | |

E-121. As soon as the tower confirms all firers are at the appropriate firing point, the tower operator proceeds to the next engagement. Table VI, Qualification, Stage 3, Night Fire, has ten firing tasks. Table E-80 lists the commands for tasks 1 through 10. The amount of ammunition that is required to fire engagement 1 through 10 of Table VI, Qualification, Night Fire tasks is two, 10-round magazines.

Table E-80. Stage 3, Night Fire engagement 1 through 6

| <i>Stage 3, Night Fire, Kneeling, Supported</i> | | | |
|--|--|--|-----------------------|
| | Engagement | Target | Target Type |
| | 1 to 6 | E-1 F-1 | Point |
| | Rounds per Target | DODIC | Time (Minutes) |
| | 1 | AB57 (5) AB74 (5) | 1:44 |
| TOWER | | SOLDIER ACTION | |
| FIRERS, | | | |
| WEAPONS SAFETY STATUS RED | SECURE ONE TEN-ROUND MAGAZINE | Soldier assumes the kneeling supported firing position, loads one 10-round magazine, ensures the weapon is on SAFE, and remains at the READY. | |
| | MAKE READY | | |
| ALERT | CONTACT | | |
| TARGET DESCRIPTION | MULTIPLE TROOPS | | |
| DIRECTION | FRONT | | |
| RANGE | MID-RANGE | | |
| METHOD | NEAR TO FAR | | |
| CONTROL | WEAPONS FREE WEAPONS FREE | Soldier moves the weapon from SAFE to FIRE, and begins the target acquisition process. | |
| EXECUTION | ENGAGE WHEN POSITIVELY IDENTIFIED | Soldier acquires, prioritizes, and engages targets with one round per target. | |
| ONCE ALL FIRERS ARE COMPLETE, TOWER CONTINUES. | | | |
| Note: There is a 5-second delay between all engagements. There is a 15-second delay at the end of the phase to support changing the magazine. | | | |
| Legend: DODIC – Department of Defense identification | | | |

Table E-80. Stage 3, Night Fire, conduct of fire (continued)

| Stage 3, Night Fire, Kneeling, Supported | | | |
|---|---|--|----------------|
| | Engagement | Target | Target Type |
| | 8 to 10 | E-1 F-1 | Point |
| | Rounds per Target | DODIC | Time (Minutes) |
| | 1 | AB57 (5) AB74 (5) | 1:11 |
| TOWER | | SOLDIER ACTION | |
| WEAPONS SAFETY STATUS RED | <i>Although the firer's bolt should be locked to the rear, the tower must treat all weapons as if in a RED status</i> | Soldier remains in the KNEELING, SUPPORTED position at the READY and may RELOAD or await instruction. | |
| CONTROL | RELOAD | The Soldier conducts an emergency RELOAD and prepares to engage. | |
| TOWER AWAITS THE END OF THE 15-SECOND TRANSITION THEN PROCEEDS | | | |
| WEAPONS SAFETY STATUS REMAINS RED | | | |
| EXECUTION | ENGAGE WHEN POSITIVELY IDENTIFIED | Soldier acquires targets, prioritizes targets, and engages targets with one round per target. | |
| ONCE ALL FIRERS ARE COMPLETE, TOWER CONTINUES. | | | |
| WEAPONS SAFETY STATUS REMAINS RED | | | |
| Note: There is a 5-second delay between all engagements. | | | |
| Legend: DODIC – Department of Defense identification code | | | |

E-122. Upon completion of Table VI, Qualification, Stage 3, Night Fire tasks and collecting their dunnage, a lane safety verifies that firers are cleared prior to moving from the firing point. Once all Soldiers have cleared, the lane safety communicates the WSS to the tower operator and the tower operator issues an administrative command moving the Soldiers off the range. Table E-81 is an example of this command.

Table E-81. Stage 3, Night Fire, completed firing order, conduct of the range example

| <i>Completed Firing Order, Conduct of the Range</i> | | | |
|--|---|---|----------------|
| NIGHT FIRE | Engagement | Target | Target Type |
| | Completed Firing Order | N/A | N/A |
| | Rounds per Target | DODIC | Time (Seconds) |
| | N/A | N/A | NO LIMIT |
| TOWER | | SOLDIER ACTION | |
| ALL FIRERS WEAPONS SAFETY STATUS IS RED | | | |
| TERMINATION | CEASE FIRE CEASE FIRE | Soldiers stop firing and place weapons on SAFE. | |
| WEAPONS SAFETY STATUS GREEN | GO GREEN GO GREEN ONCE VERIFIED SECURE WEAPON | Soldiers clear their weapon and wait to be inspected by a lane safety. | |
| ONCE ALL FIRERS ARE VERIFIED GREEN, TOWER CONTINUES. | | | |
| CONDUCT OF THE RANGE | FIRERS SECURE YOUR DUNNAGE ONCE COMPLETE, PREPARE FOR CONTINUING OPERATIONS | Firers secure weapon, ammunition dunnage, and then prepare for continuing operations. | |
| TOWER WAITS FOR ALL SOLDIERS TO REACH THE ENTRY CONTROL POINT PRIOR TO ADVANCING THE NEXT FIRING ORDER TO THE BASELINE. | | | |
| Legend: DODIC – Department of Defense identification code, N/A – not applicable | | | |

STAGE 4 – NIGHT FIRE, CHEMICAL, BIOLOGICAL, RADIOLOGICAL, AND NUCLEAR

E-123. Stage 4, Night Fire, CBRN is a required event as part of rifle and carbine qualification. The purpose of the stage 4 event is to train and evaluate the firer's ability to engage targets while operating with individual chemical protective equipment. At a minimum, Soldiers are required to fire this course of fire while wearing individual combat equipment and a protective mask with hood. All Soldiers assigned a rifle or carbine must complete this course of fire as part of their qualification based on their access to primary simulation systems (see table E-82).

Table E-82. Stage 4, Day Fire, Chemical, Biological, Radiological, and Nuclear, training environment requirement

| Supported / Available System | Authorized As | Qualification Environment Required | |
|---|---------------|------------------------------------|------------------|
| | | Virtual | Live (Live-Fire) |
| Soldier and squad virtual training system (S / SVT) | Primary | X | |
| Engagement skills trainer (EST) | Alternate | X | |
| None Available | Live-Fire | | X |

E-124. All firers who have access to an authorized primary or alternate simulation system are not authorized training ammunition to conduct this event in a live environment under live-fire conditions. Units that have secured resources may use the live-fire CBRN qualification for record.

E-125. Stage 4 is only for units that do not have access to an authorized simulator system based on the system's basis of issue plan. Failure to coordinate for the appropriate system or failure to conduct the CBRN qualification using a designated and authorized system does not authorize the use of training ammunition for this event.

AMMUNITION

E-126. To effectively plan and forecast for sufficient training ammunition, the unit uses the ammunition requirements listed in table E-83 and table E-84. Units need to identify the total number of firers. Units should plan for unscheduled firers and necessary retraining by increasing their forecasted training ammunition, as appropriate. Firers place these magazines in their magazine pouches. Staging or pre-positioning magazines is not authorized for the conduct of Table VI, CBRN, Night tasks.

Table E-83. Stage 4, Rifle and Carbine, Table VI, Night Fire, Chemical, Biological, Radiological, and Nuclear ammunition requirements

| Stage 4 | DODIC | Nomenclature | Quantity | Remarks |
|--|-------|---------------------------------|----------|--|
| Night Fire, CBRN | AB57 | CTG, 5.56mm, ball, M855A1 EPR | 5 | One round is authorized for each target presented. |
| | AB74 | CTG, 5.56mm, tracer, M855A1 EPR | 5 | One round is authorized for each target presented. |
| Legend: CBRN – chemical, biological, radiological, and nuclear; CTG – cartridge, DODIC – Department of Defense identification code, EPR – enhanced performance round, mm - millimeter | | | | |

Table E-84. Stage 4, Night Fire, Chemical, Biological, Radiological, and Nuclear ammunition breakdown

| <i>Phase</i> | <i>Sequence / Magazine</i> | <i>AB57 5.56mm, Ball</i> | <i>AB74 5.56mm, Tracer</i> | <i>Magazine Total Rounds</i> |
|--------------------------------|----------------------------|------------------------------|------------------------------------|----------------------------------|
| Standing, unsupported | 1 | 5 each | 5 each | 10 rounds |
| Legend: mm – millimeter | | | | |

SCENARIO ENGAGEMENTS

E-127. Targets are presented to the firer in single and multiple target arrays. Targets are presented so that 90-percent of the target is clearly visible to the firer from the expected or planned firing position. Targets are exposed to the firer based on the number of targets presented during the engagement as follows:

- Single target engagements are exposed for 8 seconds.
- Double target engagements are exposed for 12 seconds.
- Triple target engagements are exposed for 16 seconds.

E-128. There is a 5-second delay at night between each engagement. Table E-85, on page E-108, shows the scenario engagement sequence for CBRN qualification. The leader annotates the official record of training on DA Form 7801.

Table E-85. Stage 4, Night Fire, Chemical, Biological, Radiological, and Nuclear target engagement sequence

| <i>Stage 4, Night Fire, CBRN, Standing, Unsupported</i> | | | |
|--|--------------------|--------------|----------------------|
| <i>Engagement</i> | <i>Target Type</i> | <i>Range</i> | <i>Exposure Time</i> |
| CBRN Night 1 | F-type | 50 m RIGHT | 8 sec |
| CBRN Night 2 | E-type | 50 m LEFT | 8 sec |
| CBRN Night 3 | E-type | 100 m | 8 sec |
| CBRN Night 4 | F-type | 50 m RIGHT | 12 sec |
| | E-type | 50 m LEFT | |
| CBRN Night 5 | E-type | 50 m LEFT | 12 sec |
| | E-type | 100 m | |
| CBRN Night 6 | F-type | 50 m RIGHT | 16 sec |
| | E-type | 50 m LEFT | |
| | E-type | 100 m | |
| Standing, Unsupported, Time per Firing Order Total | | | 89 sec |
| <p>Note: There is a 5-second delay between all engagements. These engagements are done <i>after</i> Stage 3, Table VI, Qualification, Night Fire engagements.</p> | | | |
| <p>Legend: CBRN – chemical, biological, radiological, and nuclear, m – meters; sec – seconds</p> | | | |

E-129. Table E-86 provides the Table VI, Qualification, CBRN throughput schedule. Units use Table VI, Qualification as a guide. The table portrays the overall efficiency of the range facility when conducting the training event. The table provides the overall throughput timetable, based on the time the unit requires to remove one firing order from the firing positions and move the next firing order forward.

E-130. Three general movement schedules are available to assist firing order placements on the range, 2 minutes, 5 minutes, and 10 minutes. The more proficient a unit is at operating a small-arms range facility, the greater the firer throughput on the facility. This schedule does not include time required for retraining, refires, or firers who have persistent problems using a reticle.

Table E-86. Stage 4, Night Fire, Chemical, Biological, Radiological, and Nuclear throughput time schedule

| <i>Phase</i> | <i>Time to Execute</i> | | | <i>Remarks</i> | |
|---|--|--------------|---------------|---|----------------|
| Stage 4, Night Fire, CBRN, standing, unsupported | 2:29 minute | | | Includes 1 minute transition to CBRN. | |
| Total Time Per Firing Order | 5:24 minutes | | | Does not include administrative time to move firing order to or from their respective firing positions. | |
| <i>Total Number of Firing Orders</i> | <i>Night Fire Execution With Administration Time Between Firing Orders</i> | | | <i>Total Firer Throughput Based on Range Configuration</i> | |
| | <i>2 min</i> | <i>5 min</i> | <i>10 min</i> | <i>16 Lane</i> | <i>32 Lane</i> |
| 2 | 14 min | 20 min | 30 min | 32 | 64 |
| 3 | 21 min | 30 min | 45 min | 48 | 96 |
| 4 | 28 min | 40 min | 1 hr 0 min | 64 | 128 |
| 5 | 35 min | 50 min | 1 hr 15 min | 80 | 160 |
| 6 | 42 min | 1 hr 0 min | 1 hr 30 min | 96 | 192 |
| 7 | 49 min | 1 hr 10 min | 1 hr 45 min | 112 | 224 |
| 8 | 56 min | 1 hr 20 min | 2 hrs 0 min | 128 | 256 |
| 9 | 1 hr 3 min | 1 hr 30 min | 2 hrs 15 min | 144 | 288 |
| 10 | 1 hr 11 min | 1 hr 41 min | 2 hrs 31 min | 160 | 320 |
| 11 | 1 hr 18 min | 1 hr 51 min | 2 hrs 46 min | 176 | 352 |
| 12 | 1 hr 25 min | 2 hrs 1 min | 3 hrs 1 min | 192 | 384 |
| 13 | 1 hr 32 min | 2 hrs 11 min | 3 hrs 16 min | 208 | 416 |
| 14 | 1 hr 39 min | 2 hrs 21 min | 3 hrs 31 min | 224 | 448 |
| 15 | 1 hr 46 min | 2 hrs 31 min | 3 hrs 46 min | 240 | 480 |
| 16 | 1 hr 53 min | 2 hrs 41 min | 4 hrs 1 min | 256 | 512 |
| 17 | 1 hr 60 min | 2 hrs 51 min | 4 hrs 16 min | 272 | 544 |
| 18 | 2 hrs 7 min | 3 hrs 1 min | 4 hrs 31 min | 288 | 576 |
| 19 | 2 hrs 14 min | 3 hrs 11 min | 4 hrs 46 min | 304 | 608 |
| 20 | 2 hrs 21 min | 3 hrs 21 min | 5 hrs 1 min | 320 | 640 |
| Note: This throughput schedule includes stage 4, night fire, CBRN, for planning purposes to capture the full night fire requirement. | | | | | |
| Legend: CBRN – chemical, biological, radiological and nuclear; hr – hour; hrs – hours, min – minutes | | | | | |

CONDUCT OF THE RANGE

E-131. Leaders instruct Soldiers on the objectives of Table VI, Qualification, CBRN and the importance of the functional elements of the shot process. Leaders conduct Table VI, Qualification, CBRN in two scenarios containing single, double, triple, and quadruple threat presentations. Firers must hit a minimum of 7 of the 10 targets presented (70 percent) to successfully pass.

E-132. Soldiers begin Table VI, Qualification, CBRN by moving into the firing position following administrative commands from the tower operator. Soldiers enter the range and move to their firing points. Once at the firing point, firers assume a standing, unsupported firing position. Firers fire the tasks in Table VI, Qualification, CBRN from the ready throughout the duration of the course of fire. Table E-87 provides an example of the administrative commands for moving a new firing order into position.

Table E-87. Stage 4, Night Fire, Chemical, Biological, Radiological, and Nuclear, new firing order, conduct of the range example



| <i>New Firing Order, Conduct of the Range</i> | | | |
|---|---|--|-----------------------|
|  CBRN | Engagement | Target | Target Type |
| | New Firing Order | N/A | N/A |
| | Rounds per Target | DODIC | Time (Seconds) |
| | N/A | AB57 / AB74 | NO LIMIT |
| TOWER | SOLDIER ACTION | | |
| ONCE FIRERS COMPLETE THE NIGHT FIRE ENGAGEMENTS, THE TOWER CONTINUES. | | | |
| CONDUCT OF THE RANGE | FIRERS, CHEMICAL AGENTS HAVE BEEN REPORTED IN YOUR AREA GAS GAS GAS |  Soldiers don their protective equipment. | |
| ONCE ALL FIRERS HAVE COMPLETED DONNING PROTECTIVE GEAR, THE TOWER CONTINUES. | | | |
| Legend: CBRN – chemical, biological, radiological and nuclear; DODIC – Department of Defense identification code, N/A – not applicable | | | |

Table E-87. Stage 4, Night Fire, Chemical, Biological, Radiological, and Nuclear, conduct of fire, (continued)

| Stage 4, Night Fire, CBRN, Standing, Unsupported | | | |
|---|--|---|----------------|
| | Engagement | Target | Target Type |
| | 8 to 10 | E-1 F-1 | Point |
| | Rounds per Target | DODIC | Time (Seconds) |
| 1 | AB57 (5) AB74 (5) | 68 | |
| TOWER | | SOLDIER ACTION | |
| WEAPONS SAFETY STATUS RED <i>Although the firer's bolt should be locked to the rear, the tower must treat all weapons as if in a RED status</i> | | Soldier remains in the STANDING, UNSUPPORTED position at the READY and may RELOAD or await instruction. | |
| CONTROL | RELOAD | The Soldier conducts an emergency RELOAD and returns to the READY, STANDING, UNSUPPORTED position and prepares to engage. | |
| WEAPONS SAFETY STATUS REMAINS RED | | | |
| EXECUTION | ENGAGE WHEN POSITIVELY IDENTIFIED | Soldier acquires targets, prioritizes targets, and engages targets with one round per target. | |
| ONCE ALL FIRERS ARE COMPLETE, TOWER CONTINUES. | | | |
| WEAPONS SAFETY STATUS REMAINS RED | | | |
| Note: There is a 5-second delay between all engagements. | | | |
| Legend: CBRN – chemical, biological, radiological, and nuclear, DODIC – Department of Defense identification code | | | |

E-133. Upon the Soldiers' completion of stage 4, night fire, CBRN and collecting their dunnage, DDI, and magazines, a lane safety verifies the clearing prior to the firers moving from their firing point. Once the lane safety clears all Soldiers, the lane safety communicates the WSS to the tower operator and the tower operator issues an administrative command to move the Soldiers off the range. Table E-88 is an example of this command.

Table E-88. Stage 4, Night Fire, Chemical, Biological, Radiological, and Nuclear, completed firing order, conduct of the range example

| <i>Completed Firing Order, Conduct of the Range</i> | | | |
|--|--|--|-----------------------|
|  <p style="text-align: center;">CBRN</p> | Engagement | Target | Target Type |
| | Completed Firing Order | N/A | N/A |
| | Rounds per Target | DODIC | Time (Seconds) |
| | N/A | N/A | NO LIMIT |
| TOWER | | SOLDIER ACTION | |
| TOWER MUST ASSUME ALL FIRERS WEAPONS SAFETY STATUS IS RED | | | |
| TERMINATION | CEASE FIRE CEASE FIRE | Soldiers stop firing and place weapons on SAFE. | |
| WEAPONS SAFETY STATUS GREEN | GO GREEN GO GREEN | Soldiers clear their weapon and wait to be inspected by a lane safety. | |
| ONCE TOWER CONFIRMS ALL WEAPONS ARE GREEN AND CLEAR, TOWER CONTINUES | | | |
| CONDUCT OF THE RANGE | ALL CLEAR ALL CLEAR SECURE YOUR DUNNAGE MOVE TO THE ENTRY CONTROL POINT | Firers unmask, secure their weapon, ammunition, and dunnage. Once complete, they move to the range's entry control point. | |
| Tower waits for all Soldiers to reach the entry control point (ECP) prior to moving the next firing order into position. | | | |
| Legend: CBRN – chemical, biological, radiological, and nuclear, DODIC – Department of Defense identification code, N/A – not applicable | | | |

RIFLE AND CARBINE, VALIDATION

E-134. Validation is a commander's option to confirm a rudimentary level of proficiency sufficient to accept reasonable risk by extending an existing QD by six months. The validation event is used in extreme circumstances where the commander confirms a qualification or certification. These circumstances may arise in garrison and operational environments. See chapter 1, on page 1-21, for detailed information on the use of alternate courses of fire for individual weapons.

TASK, CONDITIONS, AND STANDARDS

E-135. Targets are placed in a tactical array at close quarter's distances. The ALT-C challenges firers with single stationary targets from the standing, kneeling, and prone firing positions within the effective range of the weapon. Table E-89 outlines the tasks, conditions, and standards for the conduct of rifle and carbine validation.

Table E-89. Rifle and Carbine Validation, task, conditions, and standard

| | |
|--------------------|--|
| Task: | Validate Soldier's safe use of the M16 rifle or M4 carbine by demonstrating rudimentary engagement skills. |
| Conditions: | <p>Given the following:</p> <ul style="list-style-type: none"> • Fully mission capable weapon, as assigned on the master authorization list for the unit. • Full combat uniform, issued equipment, and protective mask. • Authorized range facility and approved targetry. • Authorized ammunition. |
| Standard: | <p>For firers to receive a GO validating their existing qualification, they must:</p> <ul style="list-style-type: none"> • Place 75-percent (three of four) rounds in the six minutes of angle circle on each individual silhouette during the basic slow fire phase in the time allotted. • Place 75-percent (three of four) rounds in each individual silhouette during the intermediate, rapid fire phase in the time allotted. <p>Failure to achieve either standard during the basic or intermediate phase condemns the firer's existing qualification.</p> |

E-136. Table E-90, on page E-114, shows the training event design template for rifle and carbine validation. See TC 25-8 for additional information about authorized range facilities.

Table E-90. Training event design template for Rifle and Carbine Validation

| <i>Rifle and Carbine Validation Alternate Course of Fire (ALT-C)</i> | | | | | | |
|---|-------------|---------------------------|-------------------------|---------------------------------------|--------------------------|---------------------------------|
| EVENT NAME: | VALIDATION | ENVIRONMENT: | | LIVE | 1.0 | |
| WEAPON: | M4 / M16 | CONDITIONS: | | LIVE FIRE | | |
| CATEGORY: | FOUNDATION | PRIMARY FACILITY: | | Zero | DAYS REQUIRED | |
| PUBLICATION: | TC 3-22.9 | ALTERNATE FACILITY: | | N/A | | |
| REQUIRED: | GO APPROVAL | COMPONENT: | AC | RC | 120 SOLDIERS | |
| EXTERNAL EVAL: | PLATOON | FREQUENCY: | | | | |
| VALID FOR: | QD + 6 | ANNUAL DAYS TOTAL: | | | THROUGHPUT | |
| TABLE | | | | | | |
| | I | II | III | IV | V | VI |
| | PMI&E | PLFS | DRILLS | BASIC | PRACTICE | QUAL |
| | PRQ | PRQ | PRQ | | | VALIDATION |
| WHEN EXECUTED: | | | | | | T-X |
| CONDEMNATION CRITERIA (CC) | RULE 1 | RULE 2 | RULE 3 | RULE 4 | RULE 5 | RULE 6 |
| | TIME | KEY LEADER TURNOVER | COMMANDER ASSESSMENT | SUBORDINATE ELEMENT PROFICIENCY | SPECIALTY PROFICIENCY | STAFF SECTION PROFICIENCY |
| Remarks: Units must have the appropriate approval by their first General Officer (GO) in their chain of command to use any alternate course of fire (ALT-C) for any weapon system. | | | | | | |
| Legend: AC – active component (known as active duty), EVAL – evaluation, GO – General Officer, N/A – not applicable, PLFS – preliminary live-fire simulation, PMI&E – preliminary marksmanship instruction and evaluation, PRQ – prerequisite, QUAL – qualification, QD – qualification duration, RC – Reserve Component (known as Reserves), TC – training circular, T-X – training event exercise, TNG DAYS TO QUAL – number of training days remaining on the critical path to weapon’s qualification, Zero – basic 10 meter / 25 meter firing range (zero) | | | | | | |

AMMUNITION

E-137. ALT-C is a static, timed event of all tasks listed in Rifle and Carbine, Table V and VI. Soldiers complete all tasks sequentially as described later in this section. (See table E-91.)

Table E-91. Rifle and Carbine, Table V, Practice ammunition requirements

| Phase | DODIC | Nomenclature | Quantity | Remarks |
|---|-------|--|----------|--|
| Basic | AB57 | CTG, 5.56mm, ball, M855A1 EPR | 40 | One round per silhouette, per firing position. |
| | AB46 | CTG, 5.56mm, single round, DDI, M199A1 | 1 | Used to reinforce clearing malfunctions and to identify recoil anticipation. |
| Intermediate | AB57 | CTG, 5.56mm, ball, M855A1 EPR | 40 | One round per silhouette, per firing position. |
| | AB46 | CTG, 5.56mm, single round, DDI, M199A1 | 1 | Used to reinforce clearing malfunctions and to identify recoil anticipation. |
| Legend: CTG – cartridge, DDI – dummy, drilled, inert, DODIC – Department of Defense identification code, EPR – enhanced performance round, mm – millimeter | | | | |

E-138. Validation is a timed event of two progressive, live-fire phases that requires the firers to use their primary optic. Firers progress through the basic phase at the four firing positions, followed by execution of the intermediate phase using the four firing positions. Leaders issue every firer ammunition as shown in table E-92 to conduct the event to standard. Firers place these magazines in their magazine pouches. Staging or pre-positioning magazines is not authorized for the conduct of the validation table training.

Table E-92. Rifle and Carbine, Validation ammunition breakdown

| Phase | Position | Sequence / Magazine | AB57 5.56mm Ball | AB46 5.56mm DDI | Magazine Total Rounds |
|--|---------------------|---------------------|------------------|-----------------|-----------------------|
| Basic | Prone, Unsupported | 1 | 10 each | | 10 rounds |
| | Prone, Supported | 2 | 10 each | 1 each | 11 rounds |
| | Kneeling, Supported | 3 | 10 each | | 10 rounds |
| | Standing, Supported | 4 | 10 each | | 10 rounds |
| Intermediate | Prone, Unsupported | 5 | 10 each | | 10 rounds |
| | Prone, Supported | 6 | 10 each | 1 each | 11 rounds |
| | Kneeling, Supported | 7 | 10 each | | 10 rounds |
| | Standing, Supported | 8 | 10 each | | 10 rounds |
| Note: The 11-round magazines includes 10 each AB57 and one each AB46 randomly placed DDI. The DDI rounds <i>may not be the first or last rounds loaded</i> into the magazine. | | | | | |
| Legend: DDI – dummy, drilled, inert; mm – millimeter | | | | | |

RANGE FACILITIES

E-139. Table E-93 shows the Army-standard range facilities specifically designed to support rifle and carbine validation. Units must refer to their installation’s range operations SOPs or local training regulation to identify the weapon specific range facilities. Units use their RFMSS system for all scheduling.

Table E-93. Rifle and Carbine Validation authorized range facilities

| <i>Event</i> | <i>Target</i> | <i>Range Facility</i> |
|--|--|-----------------------|
| | | <i>Zero</i> |
| Validation | C-4, C-type, target, silhouette (NSN: 6920-01-167-1398) | P |
| Legend: NSN – national stock number, P – primary, Zero – basic 10 meter / 25 meter firing range | | |

E-140. All Soldiers assigned an M16 rifle or M4 carbine on the unit’s MAL may execute rifle and carbine validation when approved by the first general officer in their chain of command. This is NOT a qualification course of fire. The commander uses this event solely to verify basic marksmanship skills of the firer as a risk mitigation tool in extreme cases. This event does not replace the Army-standard rifle and carbine qualification.

TARGETRY

E-141. ALT-C requires the C4 target, silhouette: paper, 25 meter, alternate course “C,” record fire, M16-series. This is the only target authorized for the conduct of rifle and carbine validation (ALT-C). During the preparation phase, leaders should be familiar with the targetry used, and the sequence of the firing events. Figure E-23 shows the C4 target used during ALT-C.

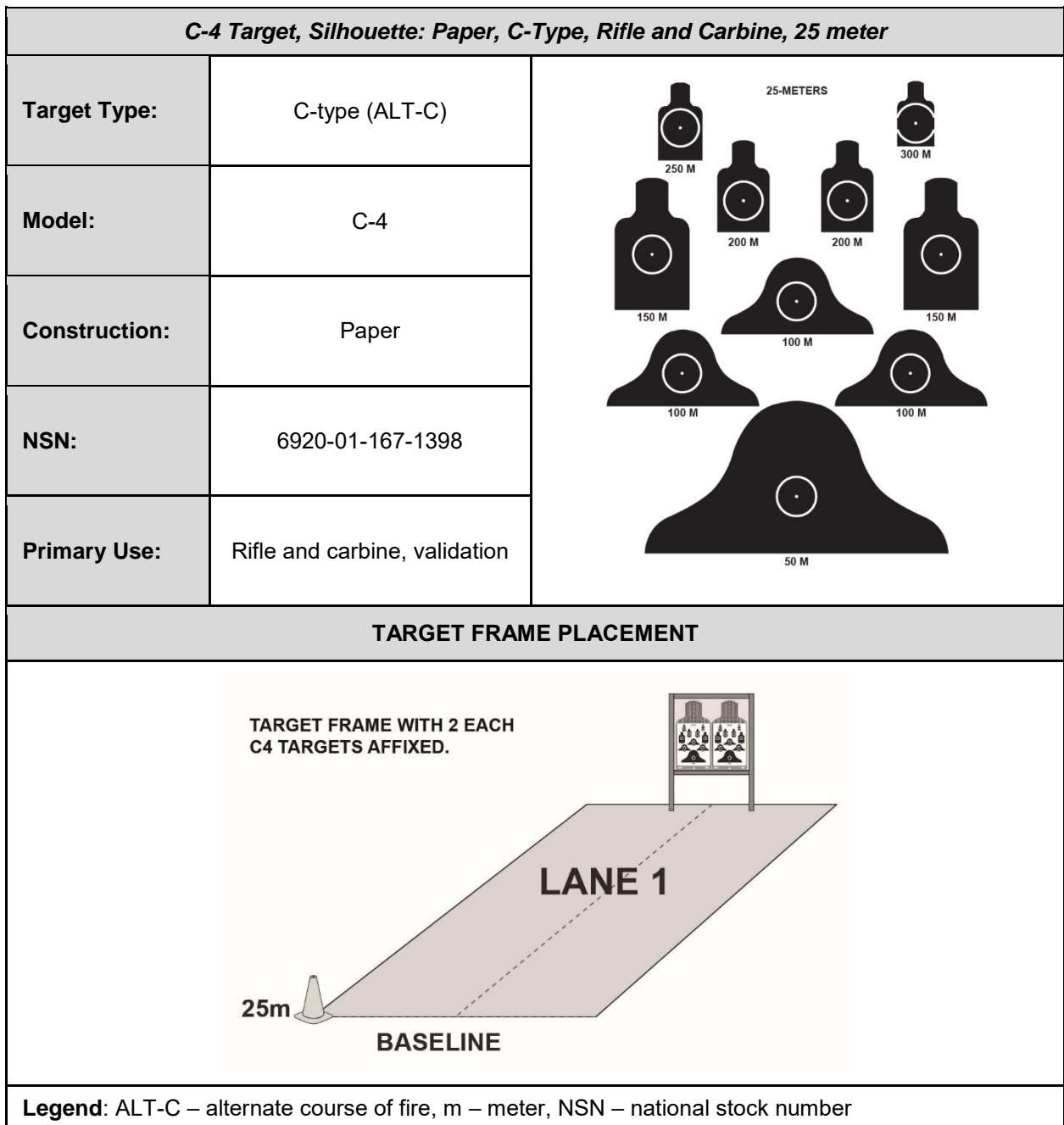

Figure E-23. Rifle and carbine, validation target information and placement

SCENARIO ENGAGEMENTS

E-142. Targets are static to the firer. Each scenario begins with an audible cue from the tower operator, typically using a shot-timer. Firers must execute the engagements as directed by the tower operator in a specific, timed sequence. This is to ensure the firers demonstrate the appropriate skills with their weapon using their primary optic and have the requisite firing techniques by firing position. The engagement sequence follows the following guidelines:

- Validation, basic engagement—
 - Eight seconds are provided to make ready.
 - Prone, unsupported, slow fire – engage each silhouette on the left C-4 target with one round within one minute (six seconds per target).
 - Ten seconds are provided to RELOAD and change position.
 - Prone, supported, slow fire – engage each silhouette on the left C-4 target with one round within one minute (six seconds per target).
 - Ten seconds are provided to RELOAD and change position.
 - Kneeling, supported, slow fire – engage each silhouette on the left C-4 target with one round within one minute (six seconds per target).
 - Ten seconds are provided to RELOAD and change position.
 - Standing, supported, slow fire – engage each silhouette on the left C-4 target with one round within one minute (six seconds per target).
 - Ten seconds are provided to RELOAD and change position.
- Validation, intermediate engagements—
 - Prone, unsupported, rapid fire – engage each silhouette on the right C-4 target with one round within 30 seconds (three seconds per target).
 - Six seconds are provided to RELOAD and change position.
 - Prone, supported, rapid fire – engage each silhouette on the right C-4 target with one round within 30 seconds (three seconds per target).
 - Six seconds are provided to RELOAD and change position.
 - Kneeling, supported, rapid fire – engage each silhouette on the right C-4 target with one round within 30 seconds (three seconds per target).
 - Six seconds are provided to RELOAD and change position.
 - Standing, supported, rapid fire – engage each silhouette on the right C-4 target with one round within 30 seconds (three seconds per target).

E-143. After each phase (prone unsupported, prone supported, kneeling supported, and standing supported), there is a 6 to 10-second transition delay giving the firer time to conduct an emergency reload and assume the next specified position. Table E-94 shows the scenario engagement sequence.

Table E-94. Rifle and Carbine Validation engagement sequence

| <i>Rifle and Carbine Validation Engagement Sequence</i> | | | | | |
|---|----------------------------------|-----------------|------------------------|--------------------------|------------------------|
| <i>Sequence</i> | <i>Engagement</i> | <i>Magazine</i> | <i>Time Per Target</i> | <i>Time Per Sequence</i> | <i>Transition Time</i> |
| | BASIC PHASE MAKE READY | | | | 10 sec |
| 1 | Prone, Unsupported | 10-round | 6 sec | 1 minute | 10 sec |
| 2 | Prone, Supported | 11-round | 6 sec | 1 minute | 10 sec |
| 3 | Kneeling, Supported | 10-round | 6 sec | 1 minute | 10 sec |
| 4 | Standing, Supported | 10-round | 6 sec | 1 minute | 10 sec |
| | INTERMEDIATE PHASE MAKE READY | | | | 10 sec |
| 5 | Prone, Unsupported | 10-round | 3 sec | 30 sec | 6 sec |
| 6 | Prone, Supported | 11-round | 3 sec | 30 sec | 6 sec |
| 7 | Kneeling, supported | 10-round | 3 sec | 30 sec | 6 sec |
| 8 | Standing, Supported | 10-round | 3 sec | 30 sec | 6 sec |
| | Time per Firing Order Total | | | 7:24 minutes | |
| Legend: sec – seconds | | | | | |

E-144. Table E-95, on page E-120, is the rifle and carbine validation throughput schedule. Units use the schedule as a guide of the overall efficiency of the range facility when conducting the training event. The schedule provides the overall throughput timetable, based on the time the unit requires to remove one firing order from the firing positions and move the next firing order forward.

E-145. Three general movement schedules are available to administer firing order placements on the range, 2 minutes, 5 minutes, and 10 minutes. The more proficient a unit is at operating a small arms range facility, the greater the firer throughput on the facility. This schedule does not include time required for retraining, refires, or firers who have persistent problems using a reticle.

Table E-95. Rifle and Carbine, Table V, Practice throughput time schedule

| <i>Phase</i> | <i>Time to Execute</i> | | | <i>Remarks</i> | |
|--|---|--------------|---------------|---|----------------|
| Slow Fire | 4:50 minutes | | | Static firing does not have a timing sequence between engagements. | |
| Rapid Fire | 2:34 minutes | | | | |
| Total Time Per Firing Order | 7:24 minutes | | | Does not include administrative time to move firing order to or from their respective firing positions. | |
| <i>Total Number of Firing Orders</i> | <i>Table V Execution With Administration Time Between Firing Orders</i> | | | <i>Total Firer Throughput Based on Range Configuration</i> | |
| | <i>2 min</i> | <i>5 min</i> | <i>10 min</i> | <i>16 Lane</i> | <i>32 Lane</i> |
| 2 | 19 min | 25 min | 35 min | 32 | 64 |
| 3 | 28 min | 37 min | 52 min | 48 | 96 |
| 4 | 38 min | 50 min | 1 hr 10 min | 64 | 128 |
| 5 | 47 min | 1 hr 2 min | 1 hr 27 min | 80 | 160 |
| 6 | 56 min | 1 hr 14 min | 1 hr 44 min | 96 | 192 |
| 7 | 1 hr 6 min | 1 hr 27 min | 2 hrs 2 min | 112 | 224 |
| 8 | 1 hr 15 min | 1 hr 39 min | 2 hrs 19 min | 128 | 256 |
| 9 | 1 hr 25 min | 1 hr 52 min | 2 hrs 37 min | 144 | 288 |
| 10 | 1 hr 34 min | 2 hrs 4 min | 2 hrs 54 min | 160 | 320 |
| 11 | 1 hr 43 min | 2 hrs 16 min | 3 hrs 11 min | 176 | 352 |
| 12 | 1 hr 53 min | 2 hrs 29 min | 3 hrs 29 min | 192 | 384 |
| 13 | 2 hrs 2 min | 2 hrs 41 min | 3 hrs 46 min | 208 | 416 |
| 14 | 2 hrs 12 min | 2 hrs 54 min | 4 hrs 4 min | 224 | 448 |
| 15 | 2 hrs 21 min | 3 hrs 6 min | 4 hrs 21 min | 240 | 480 |
| 16 | 2 hrs 30 min | 3 hrs 18 min | 4 hrs 38 min | 256 | 512 |
| 17 | 2 hrs 40 min | 3 hrs 31 min | 4 hrs 56 min | 272 | 544 |
| 18 | 2 hrs 49 min | 3 hrs 43 min | 5 hrs 13 min | 288 | 576 |
| 19 | 2 hrs 59 min | 3 hrs 56 min | 5 hrs 31 min | 304 | 608 |
| 20 | 3 hrs 8 min | 4 hrs 8 min | 5 hrs 48 min | 320 | 640 |
| Legend: hr – hour; hrs – hours, min – minutes | | | | | |

CONDUCT OF THE RANGE

E-146. Leaders instruct Soldiers on the objectives of rifle and carbine validation, and the importance of the functional elements of the shot process. Validation is conducted in two phases—basic slow fire and intermediate rapid fire. Within those phases, firers engage 10 silhouettes from four different firing positions—prone unsupported, prone supported, kneeling supported, and standing supported.

E-147. Firers must achieve 75 percent (3 of 4) hits within the 4-centimeter circle on each silhouette during the slow fire phase, and 75 percent (3 of 4) on each silhouette during the rapid fire phase to earn a GO. The GO indicates the firer validated their existing qualification successfully, and extends their existing QD by six months.

E-148. Soldiers begin ALT-C by moving into the firing position following administrative commands from the tower operator. Administrative commands control the flow of the range, movement of personnel, and other command and control purposes. Table E-96 provides an example of the tower commands for moving a new firing order into position.

Table E-96. Alternate Course of Fire, new firing order, conduct of the range example

| New Firing Order, Conduct of the Range | | | |
|---|---|--|-----------------------|
| | Engagement | Target | Target Type |
| | New Firing Order | N/A | N/A |
| | Rounds per Target | DODIC | Time (Seconds) |
| | N/A | AB57 / AB46 | NO LIMIT |
| TOWER | | SOLDIER ACTION | |
| CONDUCT OF THE RANGE | SECURE YOUR AMMUNITION AND MOVE TO YOUR FIRING POINT | Soldiers secure their weapon in a GREEN status, their training ammunition in four magazines, and move to the designated firing point. | |
| TOWER WAITS FOR ALL SOLDIERS TO REACH FIRING POINT PRIOR TO CONTINUING. | | | |
| Legend: ALT-C – alternate course of fire, DODIC – Department of Defense identification code, m – meter, N/A – not applicable | | | |

E-149. As soon as the tower confirms all firers are at the appropriate firing point, the tower operator proceeds to the next step. Rifle and carbine validation (ALT-C) has eight firing engagements. Table E-97, on page E-122, lists the commands for engagement 1; table E-98, on page E-123, lists the commands for engagement 2. Table E-99, on page E-124, lists the commands for engagement 3; table E-100, on page E-125, lists the commands for engagement 4; table E-101, on page E-126, lists the commands for 5; table E-102, on page E-127, lists the commands for engagement 6; table E-103, page E-128, lists the commands for engagement 7; table E-104, on page E-129, lists the commands for engagement 8. Firers use one magazine containing 10 rounds for each engagement.

Table E-97. Rifle and Carbine Validation, engagement 1, conduct of fire example

| <i>Rifle and Carbine Validation, Engagement 1, Slow Fire Prone Unsupported</i> | | |
|--|---|--|
|  <p>CHARLIE FOUR LEFT</p> |  <p>CHARLIE FOUR RIGHT</p> | Engagement |
| | | 1 |
| | | Target |
| | | C-4 |
| | | Target Type |
| | | Static Silhouettes |
| | | Rounds per Silhouette |
| | | DODIC |
| | | Time (Minutes) |
| | | 1 |
| | | AB57 (10) |
| | | 1:18 |
| TOWER | | SOLDIER ACTION |
| WEAPONS SAFETY STATUS RED | GO TO PRONE MAKE READY | Soldier moves to the PRONE UNSUPPORTED position, establishes a good firing position, and loads one 10-round magazine. |
| ALERT | FIRERS | |
| TARGET DESCRIPTION | CHARLIE FOUR LEFT | |
| DIRECTION | FRONT | |
| RANGE | SHORT RANGE | |
| METHOD | SLOW FIRE | |
| CONTROL | ONE ROUND PER SILHOUETTE WEAPONS FREE WEAPONS FREE | |
| EXECUTION | ENGAGE UPON POSITIVE IDENTIFICATION | Soldier begins slow firing one 10-round magazine, ensuring the same point of aim for each round. |
| TOWER PROVIDES FIRERS 60 SECONDS TO COMPLETE TASK, THEN PROCEEDS | | |
| CONTROL | WEAPONS HOLD WEAPONS HOLD RELOAD GO TO PRONE SUPPORTED | Note: WEAPONS HOLD is used to ensure firers do not continue to engage the static C-4 target until they reload and assume the next firing position. Firers conduct an emergency or tactical reload and move to the PRONE SUPPORTED position. |
| TOWER PROVIDES 10 SECONDS TO RELOAD AND CHANGE POSITION, THEN PROCEEDS | | |
| WEAPONS SAFETY STATUS REMAINS RED | | |
| Legend: DODIC – Department of Defense identification code, m – meter | | |

Table E-98. Rifle and Carbine Validation, engagement 2, conduct of fire example

| <i>Rifle and Carbine Validation, Engagement 2, Slow Fire Prone, Supported</i> | | |
|---|---|---|
|  |  | |
| CHARLIE FOUR LEFT | CHARLIE FOUR RIGHT | |
| | | Engagement |
| | | 2 |
| | | Target |
| | | C-4 |
| | | Target Type |
| | | Static Silhouettes |
| | | Rounds per Silhouette |
| | | DODIC |
| | | AB57 (10) AB46 (1) |
| | | Time (Minutes) |
| | | 1:10 |
| TOWER | | SOLDIER ACTION |
| WEAPONS SAFETY STATUS RED | | |
| ALERT | FIRERS | |
| TARGET DESCRIPTION | CHARLIE FOUR LEFT | |
| DIRECTION | FRONT | |
| RANGE | SHORT RANGE | |
| METHOD | SLOW FIRE | |
| CONTROL | ONE ROUND PER SILHOUETTE | |
| | WEAPONS FREE WEAPONS FREE | |
| EXECUTION | ENGAGE UPON POSITIVE IDENTIFICATION | Soldier begins slow firing one 10-round magazine, ensuring the same point of aim for each round. |
| TOWER PROVIDES FIRERS 60 SECONDS TO COMPLETE TASK, THEN PROCEEDS | | |
| CONTROL | WEAPONS HOLD WEAPONS HOLD RELOAD FIGHT UP | Note: WEAPONS HOLD is used to ensure firers do not continue to engage the static C-4 target until they reload and assume the next firing position. Firers conduct an emergency or tactical reload and move to the KNEELING SUPPORTED position. |
| TOWER PROVIDES 10 SECONDS TO RELOAD AND CHANGE POSITION, THEN PROCEEDS | | |
| WEAPONS SAFETY STATUS REMAINS RED | | |
| Legend: DODIC – Department of Defense identification code, m – meter | | |

Table E-99. Rifle and Carbine Validation, engagement 3, conduct of fire example

| <i>Rifle and Carbine Validation, Engagement 3, Slow Fire Kneeling, Supported</i> | | | |
|--|-------------------------------------|--|--------------------|
|  <p>CHARLIE FOUR LEFT</p> <p>CHARLIE FOUR RIGHT</p> | Engagement | Target | Target Type |
| | 3 | C-4 | Static Silhouettes |
| | Rounds per Silhouette | DODIC | Time (Minutes) |
| | 1 | AB57 (10) | 1:10 |
| TOWER | | SOLDIER ACTION | |
| WEAPONS SAFETY STATUS RED | | | |
| ALERT | FIRERS | | |
| TARGET DESCRIPTION | CHARLIE FOUR LEFT | | |
| DIRECTION | FRONT | | |
| RANGE | SHORT RANGE | | |
| METHOD | SLOW FIRE | | |
| CONTROL | ONE ROUND PER SILHOUETTE | | |
| | WEAPONS FREE WEAPONS FREE | | |
| EXECUTION | ENGAGE UPON POSITIVE IDENTIFICATION | Soldier begins slow firing one 10-round magazine, ensuring the same point of aim for each round. | |
| TOWER PROVIDES FIRERS 60 SECONDS TO COMPLETE TASK, THEN PROCEEDS | | | |
| CONTROL | WEAPONS HOLD WEAPONS HOLD | | |
| | RELOAD | | |
| | FIGHT UP | | |
| TOWER PROVIDES 10 SECONDS TO RELOAD AND CHANGE POSITION, THEN PROCEEDS | | | |
| WEAPONS SAFETY STATUS REMAINS RED | | | |
| Legend: DODIC – Department of Defense identification code, m – meter | | | |

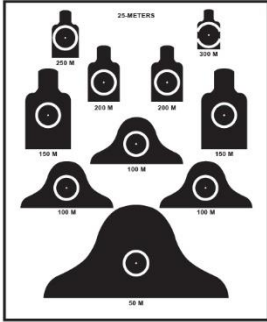
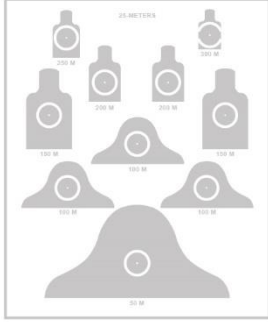
Table E-100. Rifle and Carbine Validation, engagement 4, conduct of fire example

| <i>Rifle and Carbine Validation, Engagement 4, Slow Fire Standing, Supported</i> | | |
|--|---|--|
|  <p>CHARLIE FOUR LEFT</p> <p>CHARLIE FOUR RIGHT</p> | Engagement | Target |
| | 4 | C-4 |
| | Rounds per Silhouette | DODIC |
| | 1 | AB57 (10) |
| | | Time (Minutes) |
| | | 1:10 |
| TOWER | | SOLDIER ACTION |
| WEAPONS SAFETY STATUS RED | | |
| ALERT | FIRERS | |
| TARGET DESCRIPTION | CHARLIE FOUR LEFT | |
| DIRECTION | FRONT | |
| RANGE | SHORT RANGE | |
| METHOD | SLOW FIRE | |
| CONTROL | ONE ROUND PER SILHOUETTE | |
| | WEAPONS FREE WEAPONS FREE | |
| EXECUTION | ENGAGE UPON POSITIVE IDENTIFICATION | Soldier begins slow firing one 10-round magazine, ensuring the same point of aim for each round. |
| TOWER PROVIDES FIRERS 60 SECONDS TO COMPLETE TASK, THEN PROCEEDS | | |
| CONTROL | WEAPONS HOLD WEAPONS HOLD RELOAD GO TO PRONE UNSUPPORTED | Note: WEAPONS HOLD is used to ensure firers do not continue to engage the static C-4 target until they reload and assume the next firing position. Firers conduct an emergency or tactical reload and move to the PRONE UNSUPPORTED position. |
| TOWER PROVIDES 10 SECONDS TO RELOAD AND CHANGE POSITION, THEN PROCEEDS | | |
| WEAPONS SAFETY STATUS REMAINS RED | | |
| Legend: DODIC – Department of Defense identification code, m – meter | | |

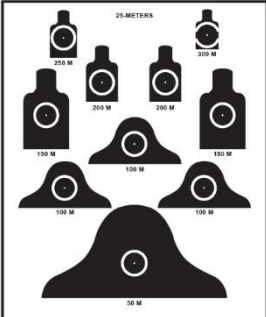
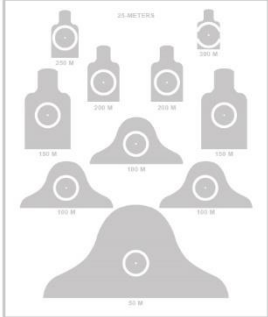
Table E-101. Rifle and Carbine Validation, engagement 5, conduct of fire example

| Rifle and Carbine Validation, Engagement 5, Rapid Fire, Prone, Unsupported | | | | | | | | | | | | | | |
|--|---|--|------------|-------------|-------------|---|-----|--------------------|-----------------------|-------|----------------|---|-----------|------|
|  <p>CHARLIE FOUR LEFT</p> |  <p>CHARLIE FOUR RIGHT</p> | <table border="1"> <tr> <th>Engagement</th> <th>Target</th> <th>Target Type</th> </tr> <tr> <td>5</td> <td>C-4</td> <td>Static Silhouettes</td> </tr> <tr> <th>Rounds per Silhouette</th> <th>DODIC</th> <th>Time (Minutes)</th> </tr> <tr> <td>1</td> <td>AB57 (10)</td> <td>0:36</td> </tr> </table> | Engagement | Target | Target Type | 5 | C-4 | Static Silhouettes | Rounds per Silhouette | DODIC | Time (Minutes) | 1 | AB57 (10) | 0:36 |
| | | Engagement | Target | Target Type | | | | | | | | | | |
| 5 | C-4 | Static Silhouettes | | | | | | | | | | | | |
| Rounds per Silhouette | DODIC | Time (Minutes) | | | | | | | | | | | | |
| 1 | AB57 (10) | 0:36 | | | | | | | | | | | | |
| TOWER | | SOLDIER ACTION | | | | | | | | | | | | |
| WEAPONS SAFETY STATUS RED | | | | | | | | | | | | | | |
| ALERT | FIRERS | | | | | | | | | | | | | |
| TARGET DESCRIPTION | CHARLIE FOUR RIGHT | | | | | | | | | | | | | |
| DIRECTION | FRONT | | | | | | | | | | | | | |
| RANGE | SHORT RANGE | | | | | | | | | | | | | |
| METHOD | RAPID FIRE | | | | | | | | | | | | | |
| CONTROL | ONE ROUND PER SILHOUETTE | | | | | | | | | | | | | |
| CONTROL | WEAPONS FREE WEAPONS FREE | | | | | | | | | | | | | |
| EXECUTION | ENGAGE UPON POSITIVE IDENTIFICATION | Soldier begins slow firing one 10-round magazine, ensuring the same point of aim for each round. | | | | | | | | | | | | |
| TOWER PROVIDES FIRERS 30 SECONDS TO COMPLETE TASK, THEN PROCEEDS | | | | | | | | | | | | | | |
| CONTROL | WEAPONS HOLD WEAPONS HOLD RELOAD GO TO PRONE SUPPORTED | Note: WEAPONS HOLD is used to ensure firers do not continue to engage the static C-4 target until they reload and assume the next firing position. Firers conduct an emergency or tactical reload and move to the PRONE SUPPORTED position. | | | | | | | | | | | | |
| TOWER PROVIDES SIX SECONDS TO RELOAD AND CHANGE POSITION, THEN PROCEEDS | | | | | | | | | | | | | | |
| WEAPONS SAFETY STATUS REMAINS RED | | | | | | | | | | | | | | |
| Legend: DODIC – Department of Defense identification code, m – meter | | | | | | | | | | | | | | |

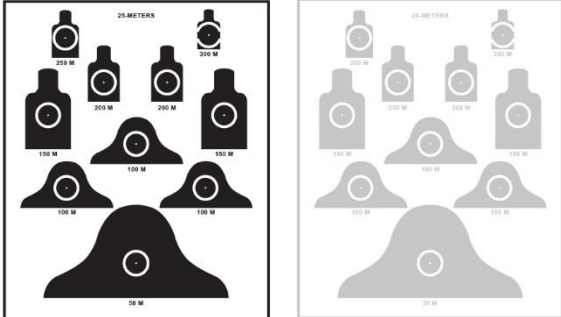
Table E-102. Rifle and Carbine Validation, engagement 6, conduct of fire example

| <i>Rifle and Carbine Validation, Engagement 6, Rapid Fire, Prone, Supported</i> | | |
|--|---|---|
|  <p>CHARLIE FOUR LEFT</p> |  <p>CHARLIE FOUR RIGHT</p> | Engagement |
| | | 6 |
| | | Target |
| | | C-4 |
| | | Target Type |
| | | Static Silhouettes |
| | | Rounds per Silhouette |
| | | DODIC |
| | | Time (Minutes) |
| | | 1 |
| | | AB57 (10) AB46 (1) |
| | | 0:36 |
| TOWER | | SOLDIER ACTION |
| WEAPONS SAFETY STATUS RED | | |
| ALERT | FIRERS | |
| TARGET DESCRIPTION | CHARLIE FOUR RIGHT | |
| DIRECTION | FRONT | |
| RANGE | SHORT RANGE | |
| METHOD | RAPID FIRE | |
| CONTROL | ONE ROUND PER SILHOUETTE | |
| | WEAPONS FREE WEAPONS FREE | |
| EXECUTION | ENGAGE UPON POSITIVE IDENTIFICATION | Soldier begins slow firing one 10-round magazine, ensuring the same point of aim for each round. |
| TOWER PROVIDES FIRERS 30 SECONDS TO COMPLETE TASK, THEN PROCEEDS | | |
| CONTROL | WEAPONS HOLD WEAPONS HOLD RELOAD FIGHT UP | Note: WEAPONS HOLD is used to ensure firers do not continue to engage the static C-4 target until they reload and assume the next firing position. Firers conduct an emergency or tactical reload and move to the KNEELING SUPPORTED position. |
| TOWER PROVIDES SIX SECONDS TO RELOAD AND CHANGE POSITION, THEN PROCEEDS | | |
| WEAPONS SAFETY STATUS REMAINS RED | | |
| Legend: DODIC – Department of Defense identification code, m – meter | | |

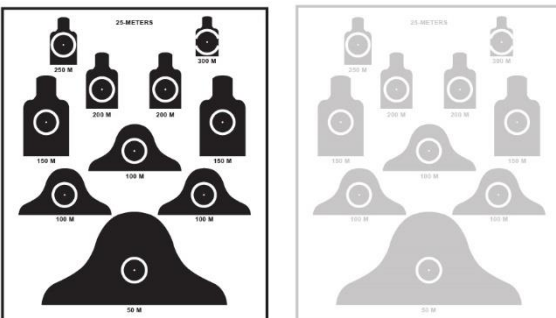
Table E-103. Rifle and Carbine Validation, engagement 7, conduct of fire example

| <i>Rifle and Carbine Validation, Engagement 7, Rapid Fire, Kneeling, Supported</i> | | | | |
|--|---|---|-----------|--------------------|
|  <p>CHARLIE FOUR LEFT</p> |  <p>CHARLIE FOUR RIGHT</p> | Engagement | Target | Target Type |
| | | 7 | C-4 | Static Silhouettes |
| | | Rounds per Silhouette | DODIC | Time (Minutes) |
| | | 1 | AB57 (10) | 0:36 |
| TOWER | | SOLDIER ACTION | | |
| WEAPONS SAFETY STATUS RED | | | | |
| ALERT | FIRERS | | | |
| TARGET DESCRIPTION | CHARLIE FOUR RIGHT | | | |
| DIRECTION | FRONT | | | |
| RANGE | SHORT RANGE | | | |
| METHOD | RAPID FIRE | | | |
| CONTROL | ONE ROUND PER SILHOUETTE | | | |
| | WEAPONS FREE WEAPONS FREE | | | |
| EXECUTION | ENGAGE UPON POSITIVE IDENTIFICATION | Soldier begins slow firing one 10-round magazine, ensuring the same point of aim for each round. | | |
| TOWER PROVIDES FIRERS 30 SECONDS TO COMPLETE TASK, THEN PROCEEDS | | | | |
| CONTROL | WEAPONS HOLD WEAPONS HOLD | Note: WEAPONS HOLD is used to ensure firers do not continue to engage the static C-4 target until they reload and assume the next firing position. Firers conduct an emergency or tactical reload and move to the STANDING SUPPORTED position. | | |
| | RELOAD FIGHT UP | | | |
| TOWER PROVIDES SIX SECONDS TO RELOAD AND CHANGE POSITION, THEN PROCEEDS | | | | |
| WEAPONS SAFETY STATUS REMAINS RED | | | | |
| Legend: DODIC – Department of Defense identification code, m – meter | | | | |

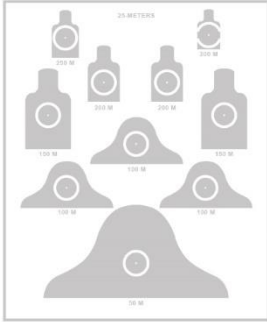
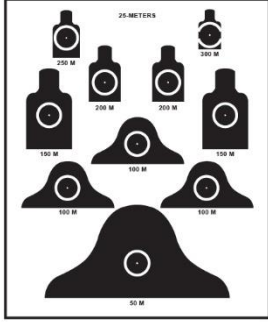
Table E-104. Rifle and Carbine Validation, engagement 8, conduct of fire example

| <i>Rifle and Carbine Validation, Engagement 8, Rapid Fire, Standing, Supported</i> | | | |
|--|-------------------------------------|--|--------------------|
|  <p>CHARLIE FOUR LEFT</p> <p>CHARLIE FOUR RIGHT</p> | Engagement | Target | Target Type |
| | 8 | C-4 | Static Silhouettes |
| | Rounds per Silhouette | DODIC | Time (Minutes) |
| | 1 | AB57 (10) | 0:30 |
| TOWER | | SOLDIER ACTION | |
| WEAPONS SAFETY STATUS RED | | | |
| ALERT | FIRERS | | |
| TARGET DESCRIPTION | CHARLIE FOUR RIGHT | | |
| DIRECTION | FRONT | | |
| RANGE | SHORT RANGE | | |
| METHOD | RAPID FIRE | | |
| CONTROL | ONE ROUND PER SILHOUETTE | | |
| | WEAPONS FREE WEAPONS FREE | | |
| EXECUTION | ENGAGE UPON POSITIVE IDENTIFICATION | Soldier begins slow firing one 10-round magazine, ensuring the same point of aim for each round. | |
| TOWER PROVIDES FIRERS 30 SECONDS TO COMPLETE TASK, THEN PROCEEDS | | | |
| CONTROL | WEAPONS HOLD WEAPONS HOLD | | |
| WEAPONS SAFETY STATUS REMAINS RED | | | |
| Legend: DODIC – Department of Defense identification code, m – meter | | | |

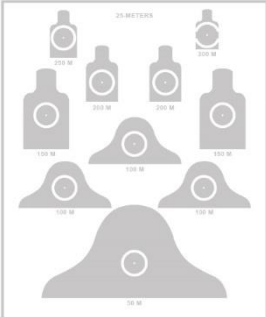
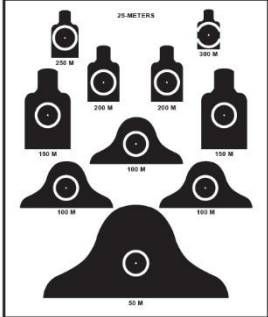
E-150. Once the firing order is complete, the tower operator directs the firers to a green weapons safety status. They also direct Soldiers to police their firing positions for brass and ammunition. Table E-105 lists an example of this command.

Table E-105. Alternate course of fire, completed firing order, conduct of the range example

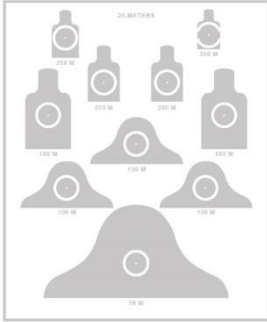
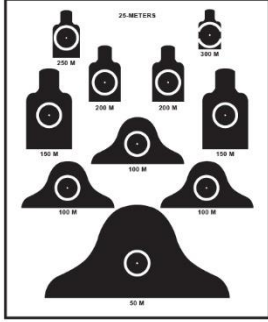
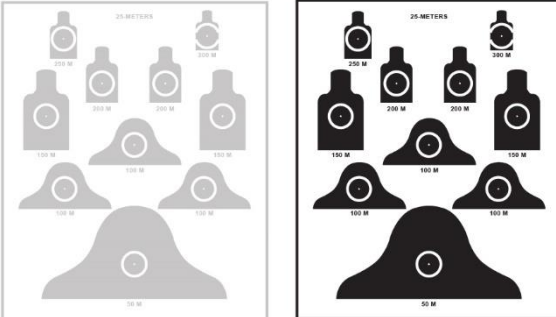
| <i>Completed Firing Order, Conduct of the Range</i> | | | |
|---|---|---|-----------------------|
| FIRING ORDER COMPLETE | Engagement | Target | Target Type |
| | Completed Firing Order | N/A | N/A |
| | Rounds per Target | DODIC | Time (Seconds) |
| | N/A | N/A | NO LIMIT |
| TOWER | SOLDIER ACTION | | |
| WEAPONS SAFETY STATUS IS CURRENTLY RED | | | |
| TERMINATION | CEASE FIRE CEASE FIRE | Soldier stops firing and places the weapon on SAFE. | |
| WEAPONS SAFETY STATUS GREEN | GO GREEN GO GREEN ONCE VERIFIED BY THE RSO, SECURE WEAPON | Soldiers clear their weapon and wait to be inspected by a lane safety. | |
| CONDUCT OF THE RANGE | FIRERS SECURE YOUR TARGET AND DUNNAGE ONCE COMPLETE MOVE TO THE ENTRY CONTROL POINT AT THE BASE OF THE TOWER. | Firers secure their targets, ammunition dunnage, and DDI, then move to the designated location. | |
| ONCE FIRING ORDER EXITS TO THE ENTRY CONTROL POINT, TOWER MOVES THE NEXT FIRING ORDER TO THE FIRING BASELINE. | | | |
| Legend: DDI – dummy, drilled, inert; DODIC – Department of Defense identification code, N/A – not applicable, RSO – range safety officer | | | |

E-151. A lane safety clears the firers upon their completion of ALT-C and collecting their dunnage. A lane safety verifies the clearing prior to the Soldiers moving from their firing point. Once the lane safety clears all Soldiers, the lane safety communicates the WSS to the tower operator and the tower operator issues an administrative command moving the Soldiers off the range.

Appendix F

Automatic Rifle

This appendix describes the Army-standard events for training through qualification of all Soldiers assigned the M249 automatic rifle. Once successfully completed, Soldiers can progress to higher levels of marksmanship training or certification, and may use the weapon during any collective live-fire training events within the qualification period.

This appendix provides an overview of the qualification standards. This appendix is divided into sections, one for each training event within the weapon’s strategy, as well as CBRN, night requirements, and an authorized ALT-C. Commanders can use this appendix as a snapshot of the Army’s requirement to achieve and sustain a level of weapons proficiency for their Soldiers who have an automatic rifle assigned to them. Soldiers assigned multiple weapons and executing the automatic rifle training strategy must be qualified on their primary assigned individual weapon and equipment within the past qualification period based on the commanders MAL.

AUTOMATIC RIFLE TRAINING STRATEGY

F-1. The standard IWTS format of six tables describes the training events. Each table explains the events with all associated resources required; ranges, simulators, simulations, ammunition, and time, as appropriate. Companies executing the training events apply the eight-step training model, as appropriate.

F-2. Table F-1 shows the automatic rifle training strategy through qualification. The table explains the sequence of training events, the days required, and the training time remaining to achieve live-fire proficiency.

Table F-1. Individual weapons training strategy structure

| | <i>Table I, PMI&E</i> | <i>Table II, PLFS</i> | <i>Table III, Drills</i> | <i>Table IV, Basic</i> | <i>Table V, Practice</i> | <i>Table VI, QUAL</i> |
|--|-------------------------------|---------------------------|------------------------------|----------------------------|------------------------------|---------------------------|
| Rifle and Carbine | | <i>Night</i> | | | | <i>Day</i> |
| | | <i>CBRN</i> | | | | <i>Night*</i> |
| | | | | | | <i>CBRN*</i> |
| | PRQ | PRQ | PRQ | REQUIRED | | REQUIRED |
| Days Required | 0.5 | 1.0 | 0.5 | 1.0 | 1.0 | 1.0 |
| <p>Legend: * - Conducted live-fire when simulator not available, CBRN – chemical, biological, radiological, nuclear, PLFS – preliminary live-fire simulation, PRQ – prerequisite, PMI&E – preliminary marksmanship instruction and evaluation, QUAL – qualification</p> | | | | | | |

F-3. Table F-2, on page F-2, illustrates ammunition required for the automatic rifle training strategy through qualification. The table includes the associated weapons by LIN and NSN, all training munitions including DDI requirements, and the live-fire training ammunition requirements.

F-4. The numbers replicate how much ammunition the unit authorizes to each firer to complete one complete iteration of each event within the training strategy through qualification. The munitions listed below do not include any retraining, cross-training, demonstration munitions, or collective training requirements.

F-5. Training ammunition is not resourced to units with access to an approved simulator system for those tasks. Units with access to approved systems complete the night and CBRN qualification requirements in the authorized system only. Units without access to an approved simulator system conduct the night fire and CBRN qualifications under live-fire conditions at the completion of Table VI, Qualification training (see stage 2, stage 3, and stage 4).

Table F-2. Automatic rifle individual weapon training strategy ammunition requirements

| <i>DODIC</i> | <i>Munition Type</i> | <i>Table III, Drills</i> | <i>Table IV, Basic</i> | <i>Table V, Practice</i> | <i>Stage 1 Table VI, QUAL</i> | <i>Total</i> |
|---|--|--------------------------|-------------------------------|---------------------------|---------------------------------|--------------|
| AB57 | CTG, 5.56mm, ball, single round, M855A1 EPR | | 35 | 50 | | 85 |
| AB56 | CTG, 5.56mm, ball, linked, M855A1 | | | 150 | 200 | 350 |
| <i>DODIC</i> | <i>Munition Type</i> | | <i>Stage 2 Day Fire, CBRN</i> | <i>Stage 3 Night Fire</i> | <i>Stage 4 Night Fire, CBRN</i> | <i>Total</i> |
| AB56 | CTG, 5.56mm, ball, linked, M855A1 | | 50 | | 50 | 100 |
| AB73 | CTG, 5.56mm, 4 ball, 1 tracer, 4:1 linked, EPR | | | 100 | | 100 |
| <i>Model</i> | <i>LIN / NSN</i> | <i>Model</i> | | <i>LIN / NSN</i> | | |
| M249AR | M09009 / 1005-01-127-7510 | | | | | |
| Note. Units are not resourced training ammunition for Table VI, Qualification, CBRN, or Table VI, Qualification, Night, when an authorized simulator system is provided as part of the basis of issue plan. | | | | | | |
| Legend: AR – automatic rifle, CBRN – chemical, biological, radiological, and nuclear, CTG – cartridge, DDI – dummy, drilled, inert, DODIC – Department of Defense identification code, EPR – enhanced performance round, LIN – line item number, mm – millimeter, NSN – national stock number, QUAL – qualification course of fire | | | | | | |

AUTOMATIC RIFLE, TABLE I, PRELIMINARY MARKSMANSHIP INSTRUCTION AND EVALUATION

F-6. The PMI&E event is a live-fire prerequisite that Soldiers must complete prior to executing any live-fire event for the automatic rifle. Automatic Rifle, Table I, PMI&E lists tasks that are critical to the safety of the firer, essential to the operation of the weapon assigned, or key to effectively employing the weapon system. Leaders use Automatic Rifle, Table I to test the Soldier’s ability to accomplish these critical tasks correctly, effectively, and efficiently. Units conduct all tasks in a garrison environment prior to the live-fire weapons training density.

TASKS, CONDITIONS, AND STANDARD

F-7. Units are encouraged to conduct preparatory training prior to Table I training (for example, hip pocket training, STT.) to maximize available resources. Units will develop a written test evaluating the functional aspects of the weapon, ammunition, and critical skills articulated in TC 3-22.249. Soldiers must successfully complete Automatic Rifle, Table I, PMI&E tasks within the training window T-6 through T-week for active Army and Reserves. (See table F-3.)

Note. Refer to TC 3-20.0 for more information on the training timelines for all live-fire prerequisites. Weapon specific and tactical employment information regarding automatic rifle is in TC 3-22.249.

F-8. At a minimum, Soldiers assigned an M249AR are provided instruction and evaluation on the standard PMI&E topics described in TC 3-22.249. Units may add topics to their Table I requirements, as necessary.

Table F-3. Automatic Rifle, Table I, Preliminary Marksmanship Instruction and Evaluation

| | |
|---|---|
| Task: | Demonstrate proficiency on the functional aspects of the weapon, optics, thermals, ammunition, and critical skills necessary to correctly and safely employ the M249 series weapon. |
| Conditions: | In a garrison environment, given an automatic rifle as assigned on the master authorization list for the unit. Provided the correct reference to conduct training: <ul style="list-style-type: none"> • TC 3-22.249. • TM 9-1005-201-10. |
| Standard: | The Soldier must successfully pass PMI&E between T-6 and T-week prior to firing any live ammunition by receiving all GOs on demonstrated performance and achieving a passing score of 80 percent or higher on a written test. |
| Legend: mm – millimeter, PMI&E – preliminary marksmanship instruction and evaluation, TC – training circular, TM – training manual | |

F-9. Table F-4, on page F-4, shows the training event design template for the Automatic Rifle, Table I, PMI&E. Units use the training event design templates to assist in the proper synchronization when developing their UTP.

Table F-4. Training event design template for Automatic Rifle, Table I

| Automatic Rifle, Table I, PMI&E | | | | | | |
|---|------------------|---------------------------|-------------------------|---------------------------------------|--------------------------|---------------------------------|
| EVENT NAME: | PMI&E | ENVIRONMENT: | | LIVE | 0.5 | |
| WEAPON: | M249AR | CONDITIONS: | | HANDS ON | | |
| CATEGORY: | PREREQUISITE | PRIMARY FACILITY: | | GARRISON | DAYS REQUIRED | |
| PUBLICATION: | TC 3-22.249 | ALTERNATE FACILITY: | | CLASS | | |
| REQUIRED: | YES | COMPONENT: | AC | RC | 60 SOLDIERS | |
| EXTERNAL EVAL: | OPTIONAL | FREQUENCY: | 2 | 1 | | |
| VALID FOR: | T+6 | ANNUAL DAYS TOTAL: | 1 | 0.5 | THROUGHPUT | |
| | TABLE | | | | | |
| | I | II | III | IV | V | VI |
| | PMI&E | PLFS | DRILLS | BASIC | PRACTICE | QUAL |
| | REQUIRED | | | | | 4.0 |
| WHEN EXECUTED: | T-6 through T-X | | | | | TNG DAYS TO QUAL |
| CONDEMNATION CRITERIA (CC) | RULE 1 | RULE 2 | RULE 3 | RULE 4 | RULE 5 | RULE 6 |
| | TIME | KEY LEADER TURNOVER | COMMANDER ASSESSMENT | SUBORDINATE ELEMENT PROFICIENCY | SPECIALTY PROFICIENCY | STAFF SECTION PROFICIENCY |
| <p>Remarks: Each Soldier assigned an individual weapon must successfully complete Table I, PMI&E, between T-6 and T-X, <i>prior to any live-fire event with the weapon.</i></p> | | | | | | |
| <p>Note: Table I <i>should</i> be completed prior to any other table to ensure the Soldier understands the proper functioning and immediate action for the weapon.</p> | | | | | | |
| <p>Legend: AC – active component (known as active duty), AR – automatic rifle, CLASS - classroom, EVAL – evaluation, PLFS – preliminary live-fire simulation, PMI&E – preliminary marksmanship instruction and evaluation, QUAL – qualification, RC – Reserve Component (known as Reserves), STT – sergeant’s time training, T+6 – training week or month plus six, TC – training circular, T-X – training event exercise, TNG DAYS TO QUAL – number of training days remaining on the critical path to weapon’s qualification</p> | | | | | | |

TRAINING PLAN

F-10. Table F-5 shows the Automatic Rifle, Table I, PMI&E training plan's tasks the Soldier demonstrates proficiency on to receive credit. Leaders and trainers must be proficient on these tasks prior to conducting training and testing.

Table F-5. Automatic Rifle, Table I, Preliminary Marksmanship Instruction and Evaluation training plan

| Reference | Topic or Task |
|---|--|
| TC 3-22.249 | Ammunition identification |
| TC 3-22.249 | Rules of fire arms safety |
| TC 3-22.249 | Weapons safety status |
| TC 3-22.249 | Weapons control status |
| TC 3-22.249 | Cycle of function, automatic rifle |
| TC 3-20.31-4 | Conduct of fire (fire commands) |
| TC 3-22.249 | Reload ammunition, automatic rifle, emergency |
| TC 3-22.249 | Reload ammunition, automatic rifle, tactical |
| TC 3-22.249 | Preliminary marksmanship instruction and evaluation (PMI&E), automatic rifle |
| 071-COM-4026 | Perform a function check on an M249 machine gun |
| 071-COM-4027 | Load an M249 machine gun |
| 071-COM-4028 | Unload an M249 machine gun |
| 071-COM-4029 | Correct malfunctions of an M249 machine gun |
| 071-COM-4025 | Maintain an M249 machine gun |
| 071-COM-4030 | Zero an M249 machine gun |
| Appropriate Technical Manual I | Mount, optic / pointer / illuminator / sensor |
| | Boresight / align optic / pointer / illuminator / sensor |
| | Zero optic / pointer / illuminator / sensor |
| | Dismount optic / pointer / illuminator / sensor |
| Note: ALL Soldiers assigned an automatic rifle will conduct PMI&E. Leaders must include the appropriate mount, boresight / align, zero, and dismounting procedures for any assigned equipment. | |
| Legend: COM – common; TC – training circular | |

AUTOMATIC RIFLE, TABLE II, PRELIMINARY LIVE-FIRE SIMULATIONS

F-11. The tasks in Table II, PLFS evaluate the Soldier's ability to engage single and multiple stationary targets from multiple stationary supported and unsupported firing positions, during day and limited visibility, and during CBRN conditions in a simulated combat environment. Soldiers are required to complete the simulations training plan prior to executing the Table II simulated qualification course of fire. The Table II task (see table F-6) is a live-fire prerequisite that Soldiers complete prior to any event using live ammunition (Tables IV, V, and VI, for example).

TASKS, CONDITIONS, AND STANDARD

F-12. Units must use the approved primary or alternate simulations to execute Table II elements for record between T-6 and T-week for the upcoming weapons training density. Units must maintain the Soldiers' training records for 12 months. When conducting live-fire events, units must have the Soldier's Table II training records readily available on the range facility.

Table F-6. Automatic Rifle, Table II, Preliminary-Live-Fire Simulations

| | |
|--------------------|--|
| Task: | Demonstrate proficiency on the functional aspects of the weapon, ammunition, and critical skills necessary to correctly use the M249 automatic rifle with associated equipment. |
| Conditions: | <p>Given the following:</p> <ul style="list-style-type: none"> • Fully mission capable weapon and equipment as assigned on the master authorization list for the unit. • Full combat uniform, issued equipment, and protective mask. • An authorized simulations device with standard training model and Automatic Rifle, Table II, Gate to Live Fire (GTLF) event. |
| Standard: | The Soldier must successfully complete the grouping and zeroing, known distance, practice, GTLF, chemical, biological, radiological, and nuclear, and unassisted night fire events with all assigned attachments between T-6 and T-week prior to firing any live ammunition. |

F-13. Table F-7 shows the general training information for planning purposes for the Automatic Rifle, Table II. The training event design template provides key training information to develop the UTP for their Soldiers.

Table F-7. Training event design template for Automatic Rifle, Table II, Preliminary-Live-Fire Simulations

| <i>Automatic Rifle, Table II, PLFS</i> | | | | | | |
|---|------------------|---------------------|----------------------|---------------------------------|-----------------------|---------------------------|
| EVENT NAME: | PLFS | ENVIRONMENT: | | VIRTUAL | 1.0 | |
| WEAPON: | M249AR | CONDITIONS: | | TADSS | | |
| CATEGORY: | PREREQUISITE | PRIMARY FACILITY: | | S/SVT | DAYS REQUIRED | |
| PUBLICATION: | TC 3-22.249 | ALTERNATE FACILITY: | | EST | | |
| REQUIRED: | YES | COMPONENT: | AC | RC | 60 SOLDIERS | |
| EXTERNAL EVAL: | OPTIONAL | FREQUENCY: | 2 | 1 | | |
| VALID FOR: | T+6 | ANNUAL DAYS TOTAL: | 1 | 0.5 | THROUGHPUT | |
| TABLE | | | | | | |
| | I | II | III | IV | V | VI |
| | PMI&E | PLFS | DRILLS | BASIC | PRACTICE | QUAL |
| | | REQUIRED | | | | 3.5 |
| WHEN EXECUTED: | T-6 through T-X | | | | | TNG DAYS TO QUAL |
| CONDEMNATION CRITERIA (CC) | RULE 1 | RULE 2 | RULE 3 | RULE 4 | RULE 5 | RULE 6 |
| | TIME | KEY LEADER TURNOVER | COMMANDER ASSESSMENT | SUBORDINATE ELEMENT PROFICIENCY | SPECIALTY PROFICIENCY | STAFF SECTION PROFICIENCY |
| <p>Remarks: Each Soldier assigned an individual weapon must successfully complete Table II, PLFS, between T-6 and T-X, prior to any live-fire event with the weapon.</p> | | | | | | |
| <p>Legend: AC – active component (known as active duty), AR – automatic rifle, EST – engagement skills trainer, EVAL – evaluation, PLFS – preliminary live-fire simulation, PMI&E – preliminary marksmanship instruction and evaluation, QUAL – qualification, RC – Reserve Component (known as Reserves), S/SVT – soldier and squad virtual trainer, T+6 – training week or month plus six, TADSS – training aids, devices, simulators, and simulations, TC – training circular, T-X – training event exercise, TNG DAYS TO QUAL – number of training days remaining on the critical path to weapon's qualification</p> | | | | | | |

SIMULATIONS

F-14. Each Soldier is authorized simulations usage for weapons training and sustainment based on their component. The authorized hours of training are cumulative annually to enable completing all required training prior to the execution of Table II training. Table F-8 shows the annual hours authorized per Soldier by component:

Table F-8. Annual simulations authorizations table

| <i>Simulation Time Authorizations (hours)</i> | |
|---|-----------------|
| <i>Active Army</i> | <i>Reserves</i> |
| 12.0 | 6.0 |

F-15. Table F-9 lists the primary and alternate simulations systems. Primary systems are the preferred method to deliver the appropriate training program to the Soldier. Alternate systems provide the minimum form, fit, and function capabilities to build the firer’s skill and experience on basic tasks. The unit determines how to use the simulations hours authorized per Soldier within the fiscal year.

Table F-9. Automatic Rifle, Table II, primary and alternate authorized systems

| <i>System</i> | <i>Primary</i> | <i>Alternate</i> | <i>Remarks</i> |
|---|----------------|------------------|---|
| Soldier and squad virtual trainer (S / SVT) | X | | |
| Engagement skills trainer (EST) | | X | Serves as a primary training device until S / SVT suite availability and accessibility are established Army-wide. |
| Dry-fire engagement drills | | X | Least preferred method. Commanders should review dry-fire drill tasks and effectiveness prior to authorizing use. |

Notes. For any other device or system not listed, the unit should contact the Maneuver Center of Excellence for possible system evaluation or to inquire if an approved training plan is available. Units are not authorized to develop training plans on systems not specifically authorized when authorized systems are available for training.

Individual weapons virtual simulation systems can support no more than two light machine gun firers per suite at a time. The standard simulations bay is composed of two suites, allowing four firers to train in a firing order. The unit should develop a rotational plan to accommodate the total number of Soldiers training.

TRAINING PLAN

F-16. Soldiers train on their weapon within the simulation system’s training plan. For simulation systems without an integrated training plan, operators must select the appropriate scenarios based on the system’s IUH.

F-17. The simulations automatic rifle training plan culminates in the system's GTLF. Units may elect to train additional advanced tactical engagement scenarios, but must conduct grouping, zeroing, confirmation at distance, application of hold-offs, practice, CBRN, night fire, and the GTLF exercises at a minimum, as listed in table F-10.

Table F-10. Automatic rifle simulations training plan

| <i>Aiming Device</i> | <i>Task</i> | <i>Exercise Name</i> | <i>Required GTLF</i> |
|---|-------------|---|----------------------|
| Iron Sights | 1 | Grouping and Zeroing | REQ |
| | 2 | Confirmation at Distance and Application of Hold-Offs | REQ |
| | 3 | Table V, Practice | REQ |
| | 4 | Table VI, Qualification | GTFLF |
| | 5 | CBRN Fire | REQ |
| | 6 | Night Fire | REQ |
| Optics | 7 | Grouping and Zeroing | REQ |
| | 8 | Confirmation at Distance and Application of Hold-Offs | REQ |
| | 9 | Table V, Practice | REQ |
| | 10 | Table VI, Qualification | GTFLF |
| | 11 | CBRN Fire | REQ |
| | 12 | Night Fire | REQ |
| Advanced Engagement Techniques | 13 | Short Range Engagements | OPT |
| | 14 | Medium Range Engagements | OPT |
| | 15 | Grazing Fire | OPT |
| | 16 | Plunging Fire | OPT |
| | 17 | Linear Target Arrays | OPT |
| Note: When thermal optics are not integrated into the approved simulations system, units should conduct dry exercises for concurrent training on Table V and Table VI with thermal optics. | | | |
| Legend: CBRN – chemical, biological, radiological, and nuclear; GTLF – gate to live fire; OPT – optional; REQ – required | | | |

AUTOMATIC RIFLE, TABLE III, DRILLS

F-18. Table III, Drills, lists a series of physical actions (drills) that a Soldier completes with their assigned weapon and equipment in a repetitious manner to demonstrate proficiency in weapons handling and movement. Soldiers must complete the task in this table prior to any live-fire event, including grouping procedures.

TASKS, CONDITIONS, AND STANDARD

F-19. Typically, units conduct Table III in a round-robin manner where the primary trainer is the team leader, squad leader, or assigned NCO. Table F-11 illustrates Table III's task, conditions, and standards.

Table F-11. Automatic Rifle, Table III, Drills, task, conditions, and standards

| | |
|--------------------|---|
| Task: | Demonstrate proficiency on the functional aspects of the weapon, ammunition, and critical skills necessary to correctly use the M249 automatic rifle with assigned equipment and attachments. |
| Conditions: | Given the following: <ul style="list-style-type: none"> • Fully mission capable, weapon and equipment as assigned on the master authorization list for the unit. • Checklist of required actions and time standards found in Training Circular 3-22.249 and associated individual task reports described in this section. |
| Standard: | The Soldier successfully demonstrates proficiency by passing weapons handling, manipulation, and movement tasks listed in the training plan between T-6 and T-week prior to firing any live ammunition. |

F-20. Table F-12 shows the general training information for planning purposes for Automatic Rifle, Table III, Drills. The training event design template provides key training information to develop the UTP for their Soldiers.

Table F-12. Training event design template for Automatic Rifle, Table III, Drills

| Automatic Rifle, Table III, Drills | | | | | | | |
|---|-------------------|---------------------|----------------------|---------------------------------|-----------------------|---------------------------|------------------|
| EVENT NAME: | DRILLS | | ENVIRONMENT: | | LIVE | 0.5 | |
| WEAPON: | M249AR | | CONDITIONS: | | HANDS ON | | |
| CATEGORY: | PREREQUISITE | | PRIMARY FACILITY: | | GARRISON | DAYS REQUIRED | |
| PUBLICATION: | TC 3-22.249 | | ALTERNATE FACILITY: | | TA | | |
| REQUIRED: | YES | | COMPONENT: | AC | RC | 60 SOLDIERS | |
| EXTERNAL EVAL: | FIRST LINE LEADER | | FREQUENCY: | 2 | 1 | | |
| VALID FOR: | T+6 | | ANNUAL DAYS TOTAL: | 1 | 0.5 | THROUGHPUT | |
| TABLE | | | | | | | |
| | | I | II | III | IV | V | VI |
| | | PMI&E | PLFS | DRILLS | BASIC | PRACTICE | QUAL |
| | | | | REQUIRED | | | 3.0 |
| WHEN EXECUTED: | T-6 through T-X | | | | | | TNG DAYS TO QUAL |
| CONDEMNATION CRITERIA (CC) | RULE 1 | RULE 2 | RULE 3 | RULE 4 | RULE 5 | RULE 6 | |
| | TIME | KEY LEADER TURNOVER | COMMANDER ASSESSMENT | SUBORDINATE ELEMENT PROFICIENCY | SPECIALTY PROFICIENCY | STAFF SECTION PROFICIENCY | |
| <p>Remarks: Each Soldier assigned an individual weapon must successfully complete Table III, between T-6 and T-X, prior to any live-fire event with the weapon. Table III should be used as concurrent training on Tables IV, V, and VI while Soldiers are awaiting training in a firing order or between day and night phases.</p> <p>Legend: AC – active component (known as active duty), AR – automatic rifle, EVAL – evaluation, PLFS – preliminary live-fire simulation, PMI&E – preliminary marksmanship instruction and evaluation, QUAL – qualification, RC – Reserve Component (known as Reserves), T+6 – training week or month plus six, TA – training area, TC – training circular, T-X – training event exercise, TNG DAYS TO QUAL – number of training days remaining on the critical path to weapon's qualification</p> | | | | | | | |

TRAINING PLAN

F-21. Table F-13, on page F-12, lists the individual tasks for each of these drills. The individual task reports for the drills are in a shared folder on AKO. The hyperlink to this folder is in the reference section at the back of this publication.

Table F-13. Automatic Rifle, Table III, Drills individual training plan

| Task | Task Name |
|--|--|
| 1 | Precombat checks |
| 2 | Load and conduct status check |
| 3 | Carry positions |
| 4 | Fight down |
| 5 | Fight up |
| 6 | Go to prone |
| 7* | Transition from primary weapon to secondary weapon |
| 8 | Reload |
| 9 | Clear malfunction |
| 10 | Unload / show clear |
| 11 | Barrel change |
| <p>Note. Where the individual task reports are not available on the Army Training Network, the individual task reports for these drills are in a shared folder on Army Knowledge Online. The hyperlink to this folder is in the reference section at the back of this publication.</p> <p>* This drill is only for Soldiers assigned multiple individual weapons or Soldiers assigned an individual weapon with a special purpose weapon.</p> | |

F-22. Units may add to the drills listed in table F-13, but may not remove any from Table III. Units developing additional drills are encouraged to provide the details of the drill, evaluation process, and timing considerations to the proponent of this publication for possible inclusion into future updates.

AUTOMATIC RIFLE, TABLE IV, BASIC

F-23. Units conduct Automatic Rifle, Table IV, Basic, which consists of four stages with live ammunition on an approved range facility. Leaders use Table IV for all firers to evaluate their ability to consistently place shot groups in a designated diameter circle on a target at 25 meters, followed by confirming the zero is acceptable at true distance and then applying hold-offs at 100 and 200 meters. Units conduct the tasks in this table only after successful completion of the live-fire prerequisite tables (Tables I, II, and III). During home station training, Soldiers must complete Table IV tasks prior to progressing to any other training event. Units conduct Table IV tasks on an ARF or other approved facility.

TASK, CONDITIONS, AND STANDARD

F-24. Firers conduct Table IV tasks from the prone supported firing position 25 meters from the targets outlined in this chapter. Table IV tasks reinforce and build upon the skills Soldiers learned in the previous training events. Table F-14 provides the task, conditions, and standards for Table IV.

Table F-14. Automatic Rifle, Table IV, Basic

| | |
|---|---|
| Task: | Conduct grouping, zeroing, confirmation of zero at distance, using slow-fire engagement procedures with the M249 automatic rifle (AR) with the primary optic. |
| Conditions: | Given the following: <ul style="list-style-type: none"> • Fully mission capable weapon, ammunition pouches, and magazines. • Authorized range facility, full-caliber ammunition, and approved targetry. • Unit selected method of zeroing (as described in Training Circular 3-22.249). |
| Standard: | <p>Grouping – Successfully group by placing four of five rounds in two consecutive five-round shot groups within a 6 minute of angle (MOA) circle (threshold) or 4 MOA (objective) at 25-meters.</p> <p>Zeroing – Successfully place four of five rounds in two consecutive shot groups within the 6 MOA circle (threshold) or 4 MOA (objective) surrounding the appropriate point of impact on the A8 zero target at 25-meters.</p> <p>Confirmation at Distance – after completion of the 25-meter zero, the Soldier must successfully hit a properly presented E-type target with a minimum of four of five (80-percent) shots.</p> <p>Application of Hold-Offs – After completion of confirmation at distance stage the Soldier must successfully hit a properly presented 100 meter E-type target with a minimum of four of five (80-percent) shots then the Soldier must also successfully hit a properly presented 200 meter E-type target with a minimum of four of five (80-percent) shots.</p> |
| Note. The M249AR grouping and zeroing tasks will use individually loaded single round magazines rather than belted ammunition to ensure the tightest shot group is achieved. | |

F-25. Table F-15, on page F-14, shows the training event design template for the Table IV, Basic. Units conduct this event on an authorized live-fire facility, typically an ARF. See TC 25-8 for additional information on authorized range facilities.

Table F-15. Training event design template for Automatic Rifle, Table IV, Basic

| <i>Automatic Rifle, Table IV, Basic</i> | | | | | | |
|--|-------------|---------------------------|-------------------------|---------------------------------------|--------------------------|---------------------------------|
| EVENT NAME: | BASIC | | ENVIRONMENT: | LIVE | | 1.0 |
| WEAPON: | M249AR | | CONDITIONS: | LIVE FIRE | | |
| CATEGORY: | REQUIRED | | PRIMARY FACILITY: | ARF | | DAYS REQUIRED |
| PUBLICATION: | TC 3-22.249 | | ALTERNATE FACILITY: | QTR | | |
| REQUIRED: | YES | | COMPONENT: | AC | RC | 120 SOLDIERS |
| EXTERNAL EVAL: | COACH | | FREQUENCY: | 2 | 1 | |
| VALID FOR: | T-X | | ANNUAL DAYS TOTAL: | 2 | 1 | THROUGHPUT |
| TABLE | | | | | | |
| | I | II | III | IV | V | VI |
| | PMI&E | PLFS | DRILLS | BASIC | PRACTICE | QUAL |
| | PRQ | PRQ | PRQ | REQUIRED | | 2.0 |
| WHEN EXECUTED: | | | | T-X | | TNG DAYS TO QUAL |
| CONDEMNATION CRITERIA (CC) | RULE 1 | RULE 2 | RULE 3 | RULE 4 | RULE 5 | RULE 6 |
| | TIME | KEY LEADER TURNOVER | COMMANDER ASSESSMENT | SUBORDINATE ELEMENT PROFICIENCY | SPECIALTY PROFICIENCY | STAFF SECTION PROFICIENCY |
| Remarks: Each Soldier assigned an individual weapon must successfully complete Table IV, Basic. | | | | | | |
| Legend: AC – active component (known as active duty), ARF – automated record fire range, AR – automatic rifle, EVAL – evaluation, MRF – modified record fire range or similar, PLFS – preliminary live-fire simulation, PMI&E – preliminary marksmanship instruction and evaluation, PRQ – prerequisite, QTR – qualification training range, QUAL – qualification, RC – Reserve Component (known as Reserves), TC – training circular, T-X – training event exercise, TNG DAYS TO QUAL – number of training days remaining on the critical path to weapon’s qualification | | | | | | |

AMMUNITION

F-26. All Soldiers assigned an automatic rifle on a unit MAL must complete all four stages listed in Automatic Rifle, Table IV prior to advancing to Table V or Table VI. Units conduct tasks in this table to demonstrate the Soldier’s ability to place well-aimed shots at or near the intended point of impact of a target consistently.

F-27. Firers conduct Table IV tasks based on their primary optic assigned. Firers that are not assigned an optic complete only the four stages of this table with iron sight. For those firers assigned an optic, they must complete the backup iron sight and optic grouping and zeroing. Firers with the iron sight and optic will conduct confirmation at distance with the primary aiming device only. Table F-16 shows the optics, the line item number, and associated NSNs that are authorized ammunition for the iron sight and the primary optic.

Table F-16. Table IV, Basic, primary optics

| Optic | LIN | NSN | | |
|--|--------|------------------|------------------|------------------|
| Iron Sights | | | | |
| M68, CCO | S60288 | 1240-01-411-1265 | 1240-01-540-3690 | 1240-01-576-6134 |
| M150, RCO | S45729 | 1240-01-557-1897 | | |
| M145, MGO | | 1240-01-411-6350 | | |
| <p>Note. All firers will complete grouping, zeroing, confirmation at distance, and application of hold-offs with primary aiming device.</p> <p>M68, COMP 2, NSN 1240-01-411-1265, may not be used on the M249AR.</p> <p>Authorized M249AR optics – M145, MGO</p> <p>Legend: AR – automatic rifle, CCO – close combat optic, LIN – line item number, MGO – machine gun optic, M145, RCO – rifle combat optic, NSN – national stock number</p> | | | | |

F-28. To effectively plan and forecast for sufficient training ammunition, the unit should refer to the ammunition requirements listed in table F-17. Units must identify the total number of firers and should plan for unscheduled firers and necessary retraining by increasing their forecasted training ammunition appropriately.

Table F-17. Table IV, Basic, ammunition authorizations

| Optic | Training Event | DODIC | Nomenclature | Quantity | Remarks |
|--|----------------------------------|-------|-----------------------------|----------|--|
| Iron sights or primary aiming device | Stage 1 Grouping | AB57 | CTG 5.56mm ball, M855A1 EPR | 15 | Three each, 5-round shot groups. |
| | Stage 2 Zeroing | AB57 | CTG 5.56mm ball, M855A1 EPR | 15 | Three each, 5-round shot groups after grouping exercise complete. |
| | Stage 3 Confirmation at Distance | AB57 | CTG 5.56mm ball, M855A1 EPR | 5 | One each, 5-round shot group <i>only after successful zeroing the primary optic.</i> |
| | Stage 4 Application of Hold-Offs | AB57 | CTG 5.56mm ball, M855A1 EPR | 10 | One each, 5-round shot group for 100 meter target and 200 meter target. |
| <p>Note. All firers will complete grouping, zeroing, for both iron sight and primary optic. Firers will conduct confirmation at distance and application of hold-offs with their primary aiming device only.</p> <p>There are no dummy, drilled, inert (DDI) authorized for training during Table IV for the M249AR. Reloading from belted munitions to magazine to belted munitions is completed during Table V and Table VI.</p> <p>Legend: AR – automatic rifle, CTG – cartridge, DODIC – Department of Defense identification code, EPR – enhanced performance round, mm – millimeter,</p> | | | | | |

F-29. The ammunition NCO with a supporting detail (ammunition detail) loads the magazines for the firers. Units may issue each firer clips of ammunition that they load individually for grouping, zeroing, confirmation at distance, and application of hold-offs. The grouping and zeroing engagements use five magazines loaded with one round each. Firers should be given time to load their five magazines between engagements. (See table F-18.)

Table F-18. Automatic Rifle, Table IV, ammunition breakdown per firer

| <i>Engagement Sequence</i> | <i>Exercise</i> | <i>AB57 5.56mm EPR, Ball Single Round</i> | <i>Total Rounds</i> |
|--|--------------------------|---|---------------------|
| 1 | Grouping | 5 each | 5 rounds |
| 2 | Grouping | 5 each | 5 rounds |
| 3 | Grouping | 5 each | 5 rounds |
| 4 | Zero | 5 each | 5 rounds |
| 5 | Zero | 5 each | 5 rounds |
| 6 | Zero | 5 each | 5 rounds |
| 7 | Confirmation | 5 each | 5 rounds |
| 8 | Application of Hold-offs | 10 each | 10 rounds |
| | Total: | 45 rounds | 45 rounds |
| <p>Note: When zero confirmation cannot be fired on the scheduled range facility, units should include that task with associated ammunition in their Table V, Practice event. The task is integrated into the Table V scenario, prior to the first Table V engagement.</p> | | | |
| <p>Legend: EPR – enhanced performance round; mm – millimeter</p> | | | |

RANGE FACILITIES

F-30. Table F-19 shows the Army-standard range facilities designed to support Automatic Rifle, Table IV, Basic (Grouping). Units reference their installation’s range operations SOPs or local training regulation to identify the weapon-specific range facilities on the supporting installation. Units use their RFMSS system for all scheduling.

Table F-19. Automatic Rifle Table IV, Basic (Grouping) authorized range facilities and targetry

| Table IV Exercise | Range Facility | | | |
|---|----------------|-----|-----|------|
| | ARF | MRF | QTR | Zero |
| Grouping 25 meters | P | P | P | A |
| Zeroing 25 meters | | | | |
| Confirmation at Distance | P | P | P | N/A |
| Application of Hold- Offs | | | | |
| Legend: A – alternate facility, ARF – automated record fire range, MRF – modified record fire range, N/A – not applicable, NSN – national stock number, P – primary facility, QTR – automated qualification training range, Zero – basic 10 meter / 25 meter firing range (zero) | | | | |

TARGETRY

F-31. Table IV, grouping and zeroing requires a minimum of three targets per firer, placed on a target frame as shown on figure F-1, on page F-18. The targets are placed on a frame with backer board at the 25-meter line. This is a static target presentation and does not use the automated targets on the primary range facility (ARF). During the preparation phase, leaders should be familiar with the targetry used, the target frames and their proper emplacement, and the firing sequence of the engagements. Figure F-2, on page F-19, shows the primary targets and their proper positioning on the primary range facility.

Note. The A8 target was designed with MOA corrections. The M249 AR (LIN M09009) iron sight adjustments are graduated in milradians and not MOA.



| Table IV Exercise | Targetry | |
|--|--|--|
| Grouping 25 meters | A8, target zero M4- / M16-series weapons 25 meter zero. Short range and pistol marksmanship target. |  |
| Zeroing 25 meters | | |
| Confirmation at distance | E-1, target, silhouette: plastic, polyethylene, kneeling NSN 6920-00-071-4780 |  |
| | D-1, target, 3-dimensional: plastic, mannequin, kneeling NSN 6920-01-164-9625 |  |
| Legend: NSN – national stock number, zero – basic 10 meter / 25 meter firing range (zero) | | |

Figure F-1. Automatic rifle, Table IV, target requirements example

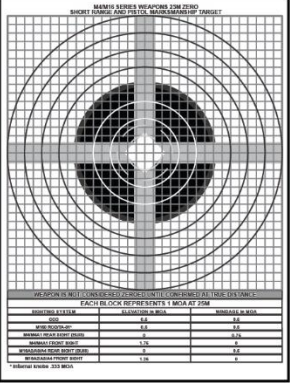
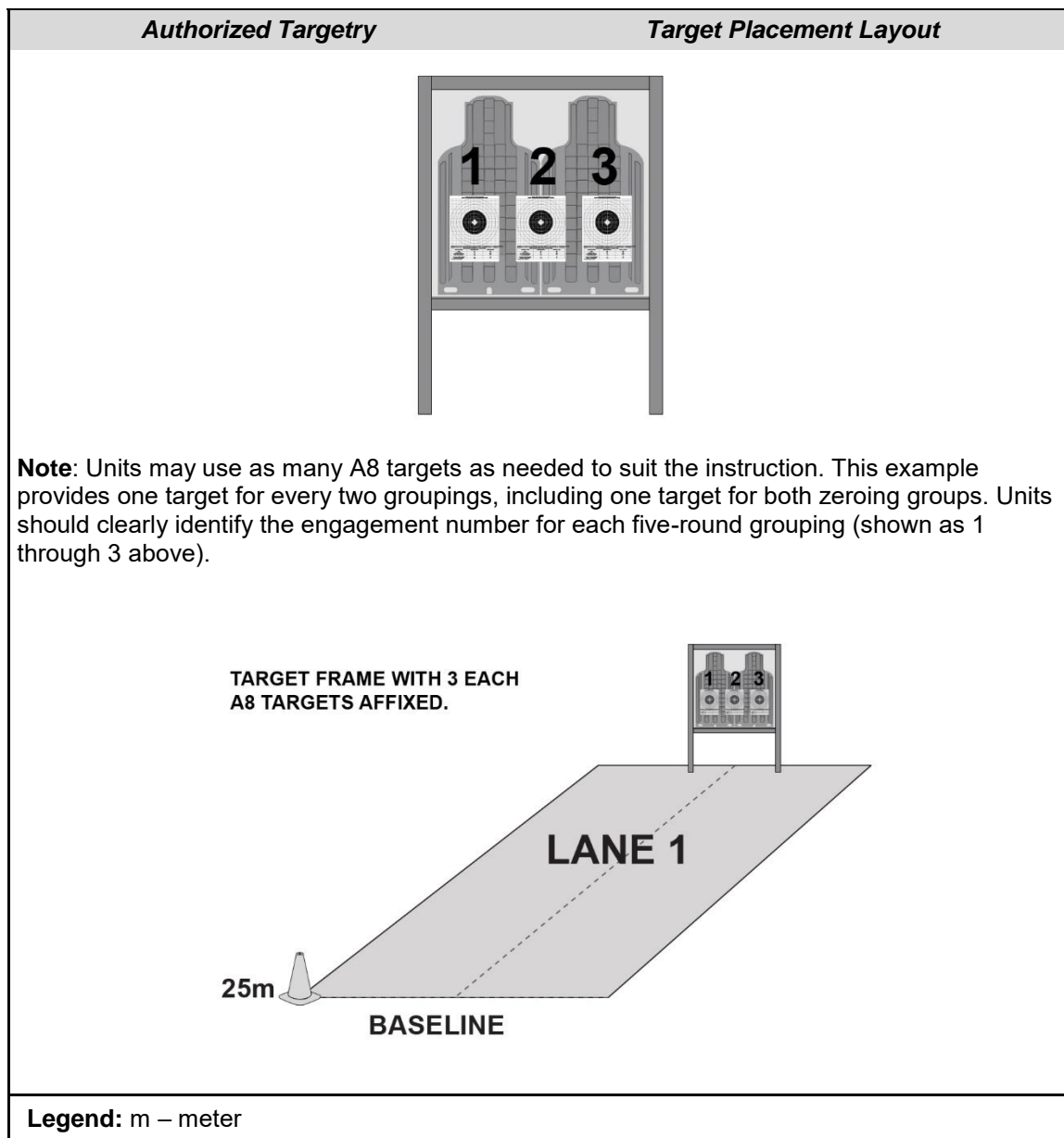

Figure F-2. Automatic rifle, Table IV, target requirements example

CONDUCT OF THE RANGE

F-32. Leaders instruct Soldiers on the objectives of grouping and the importance of the functional elements of the shot process (see TC 3-22.249). Units conduct the sequence in Table IV using eight separate engagements at targets 25-meters from the static firing point, with a zero confirmation target at distance (300 meter standard), and two targets one placed at 100 meters and one placed at 200 meters for the firer to apply hold-offs. Firers use one A-8 target for every two groupings. Soldiers complete the engagements in the sequence shown in table F-20, on page F-20.

Table F-20. Automatic Rifle, Table IV, firing sequence example

| <i>Sequence / Magazine</i> | <i>AB57 5.56mm Ball</i> | <i>Target Frame</i> | <i>Target Type</i> |
|---|-------------------------|-------------------------|--------------------|
| 1 Group 1 | 5 each | 1 | A8 |
| 2 Group 2 | 5 each | 1 | A8 |
| 3 Group 3 | 5 each | 2 | A8 |
| 4 Group 4 | 5 each | 2 | A8 |
| 5 Zero 1 | 5 each | 3 | A8 |
| 6 Zero 2 | 5 each | 3 | A8 |
| 7 Confirm at distance | 5 each | 300 meter | E-type |
| 8 Application of hold-offs | 10 each | 100 meter and 200 meter | E-type |
| <p>Note. All Table IV tasks will require five each magazines loaded with one single round. Units may choose to issue 45 rounds to each firer who will manually load the magazines. This ensures the firer builds the tightest shot group, removes trigger control errors from the firing tasks, and has the opportunity to refine their zero at true distance and apply hold-offs, as appropriate.</p> <p>Legend: mm - millimeter</p> | | | |

F-33. To successfully complete Table IV tasks, firers must meet the unit directed standard (threshold or objective) for their iron sight and optic when assigned. Table F-21 provides each threshold and objective standard for a shot group, grouping exercise, and zeroing.

Table F-21. Shot group, grouping, and zeroing standards

| <i>Type</i> | <i>Standard</i> | | <i>Requirement</i> |
|--|------------------|------------------|--|
| | Threshold | Objective | |
| Shot group | 6 MOA | 4 MOA | Four of five rounds (80-percent) |
| Grouping | 6 MOA | 4 MOA | Two shot groups to standard |
| Begin zeroing | | | Grouping standard met |
| Zero | 6 MOA | 4 MOA | Standard shot group centered at the POA. |
| Legend: MOA – minute of angle, POA – point of aim | | | |

F-34. Figures F-3 through F-20, on pages F-22 to F-39, provide the sequence of the engagements, with a basic example of the standards for a shot group, grouping, and zeroing procedure. This is a guide for the leader. See the appropriate TMs and TC 3-22.249 for detailed instructions.

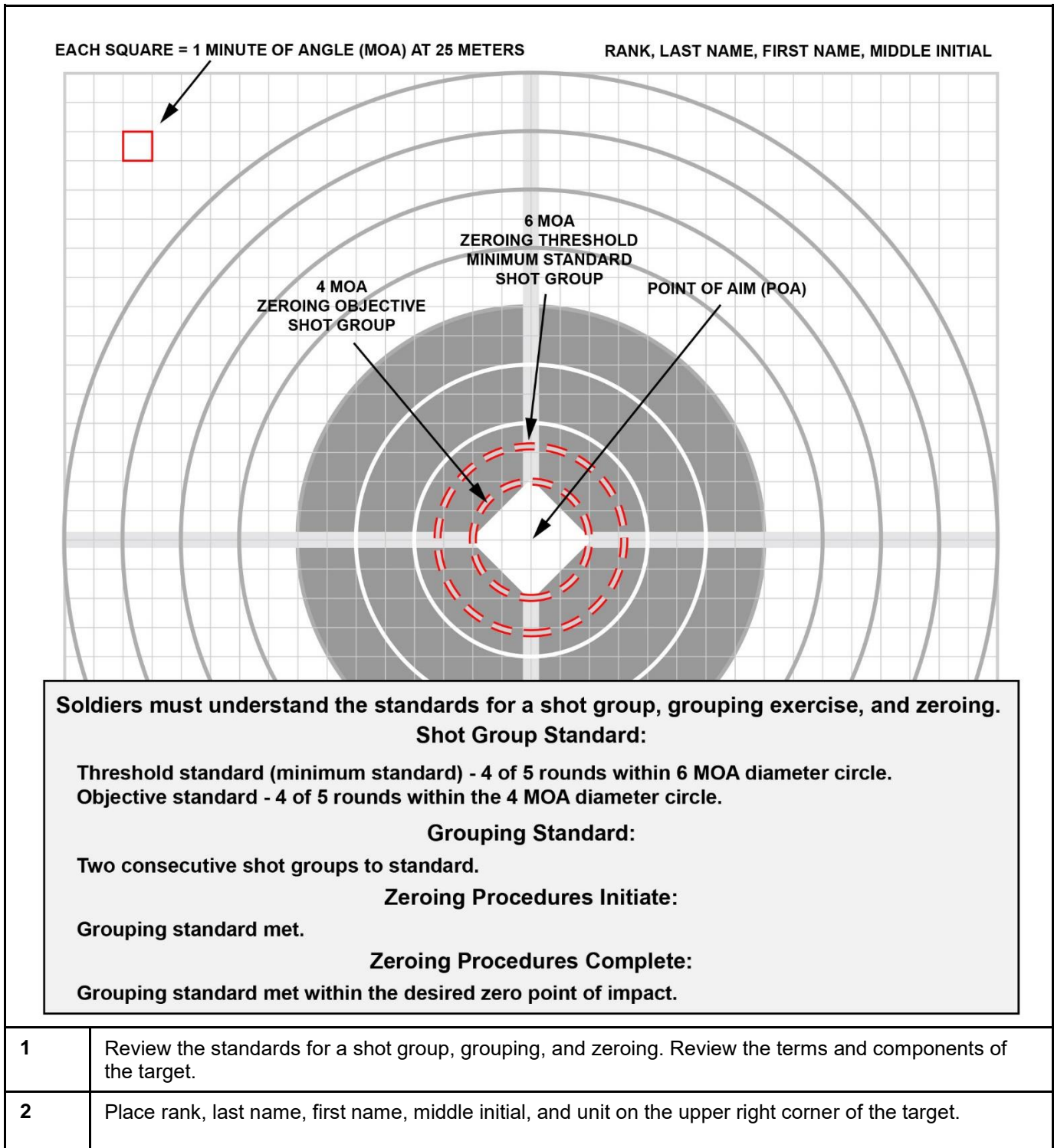

Figure F-3. Automatic rifle, Table IV standards

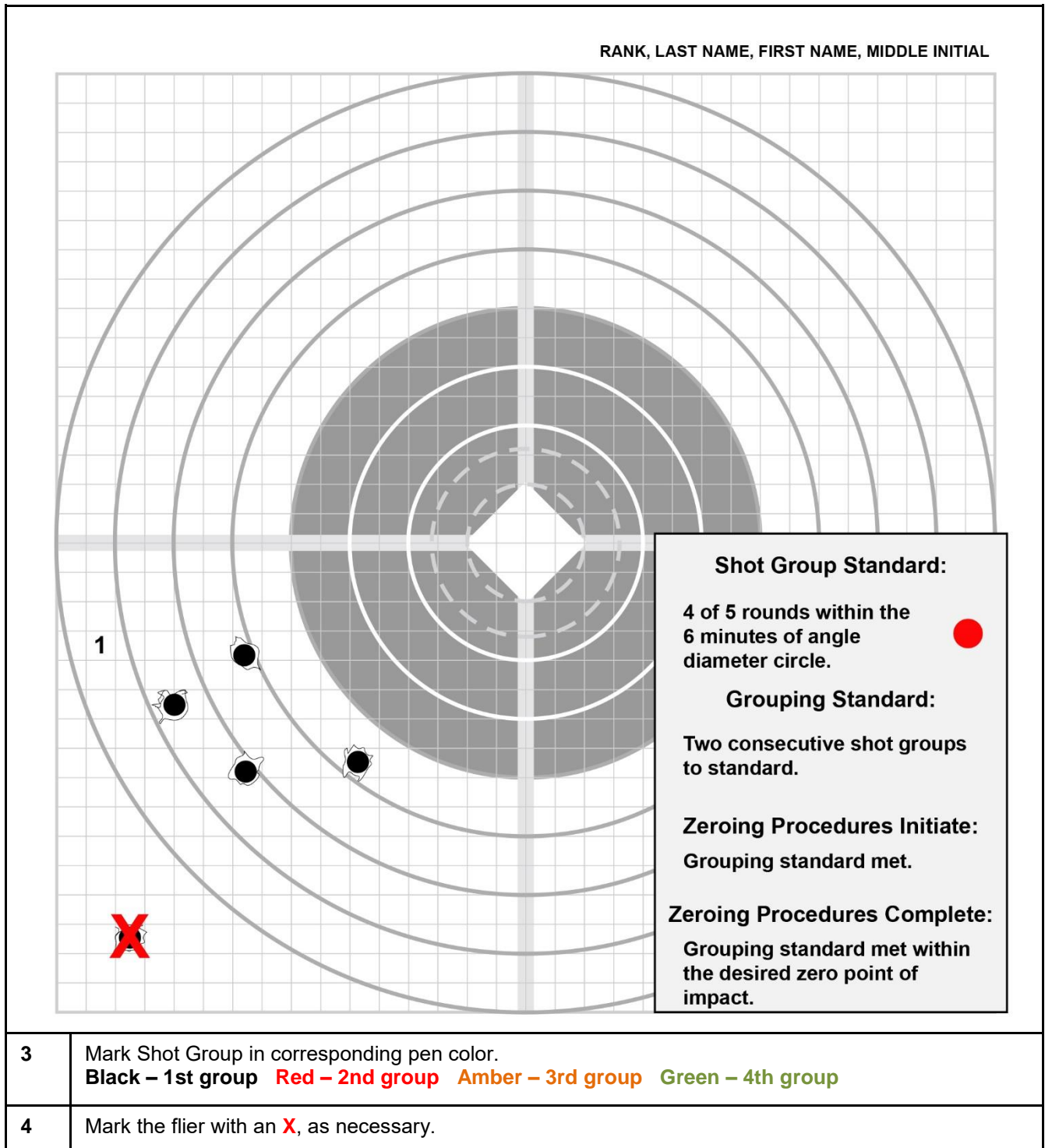

Figure F-4. Automatic rifle, group 1

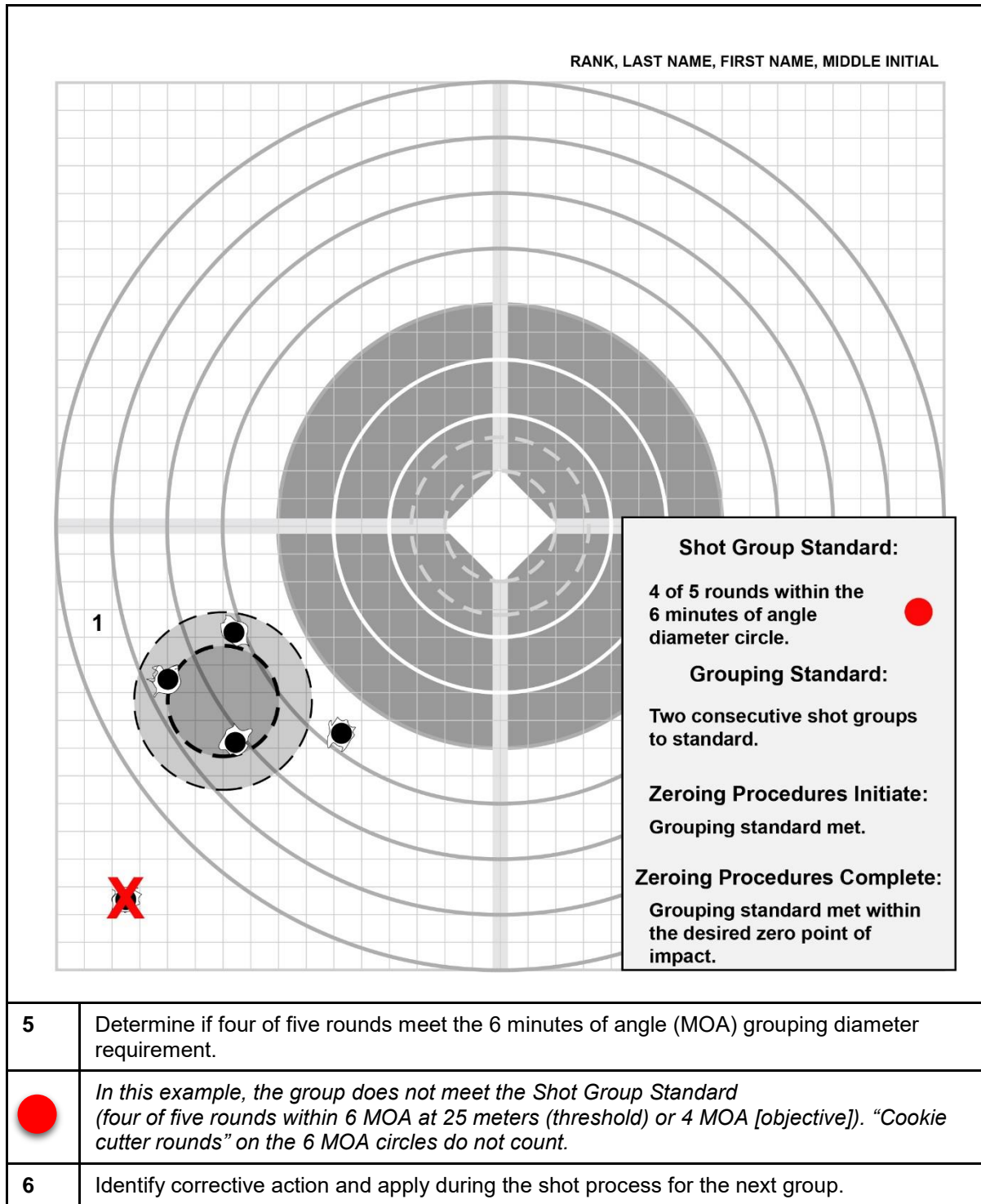

Figure F-5. Automatic rifle group 1 grouping standard determination

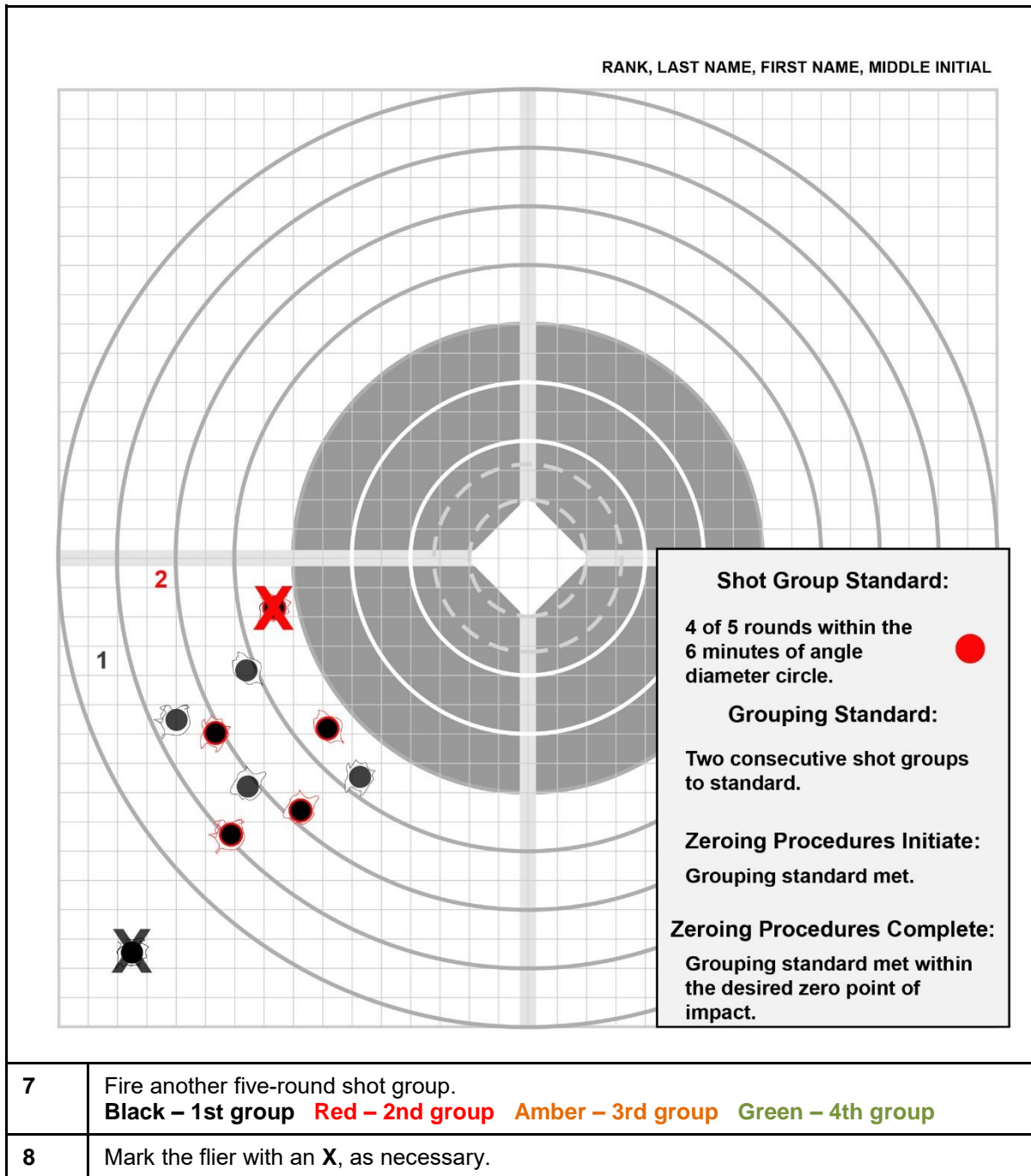

Figure F-6. Automatic rifle group 2

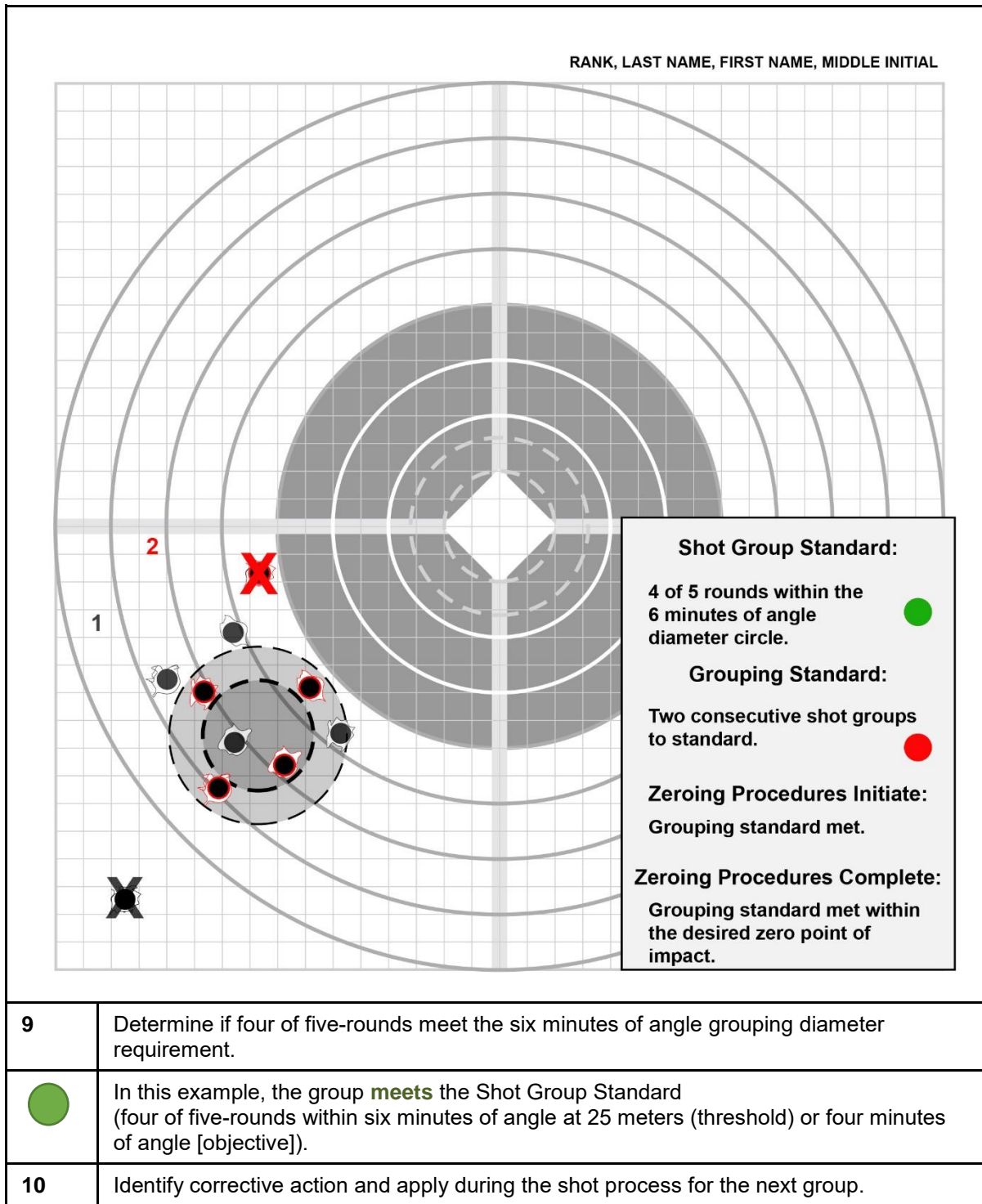

Figure F-7. Automatic rifle group 2 grouping standard determination

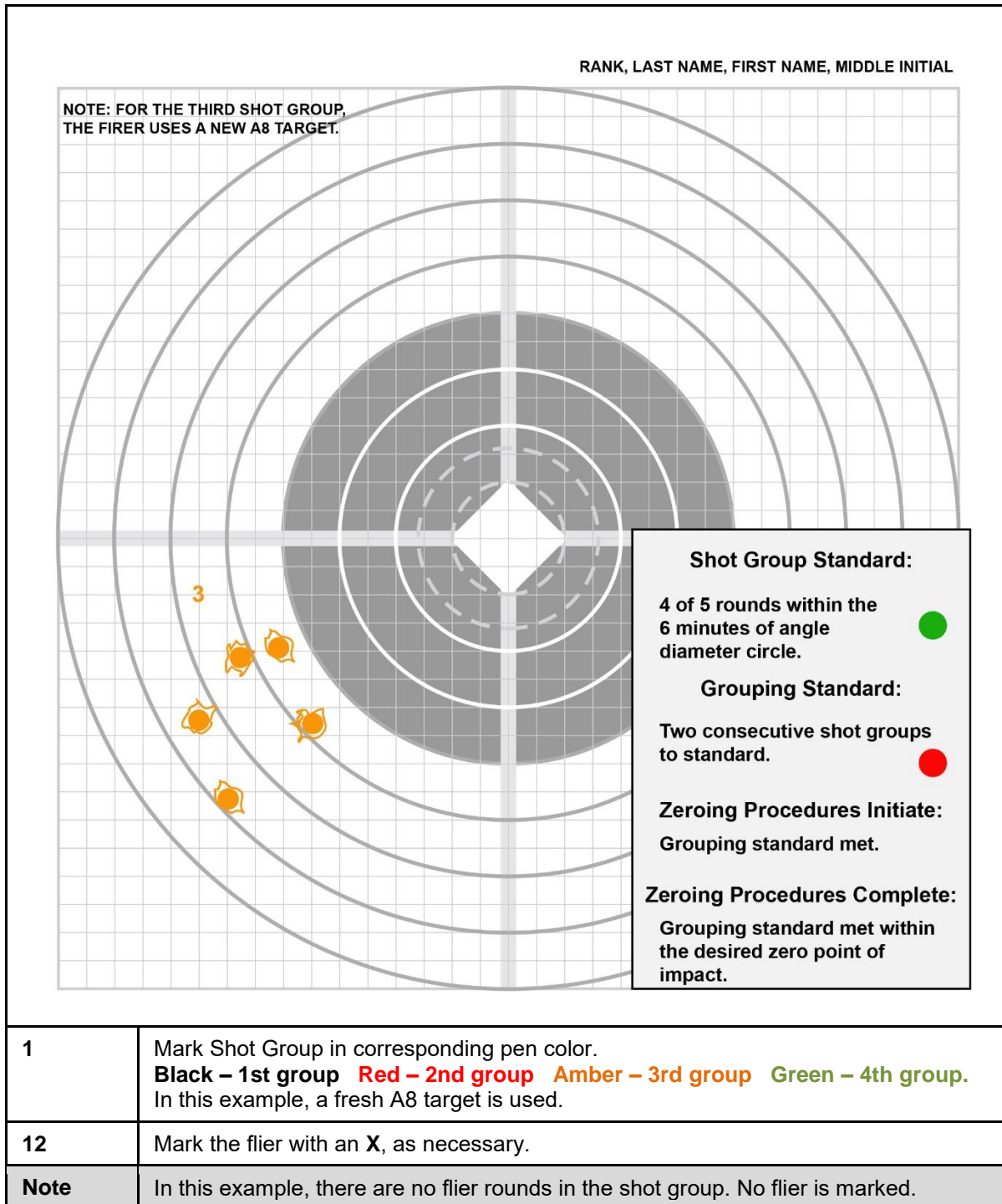

Figure F-8. Automatic rifle group 3

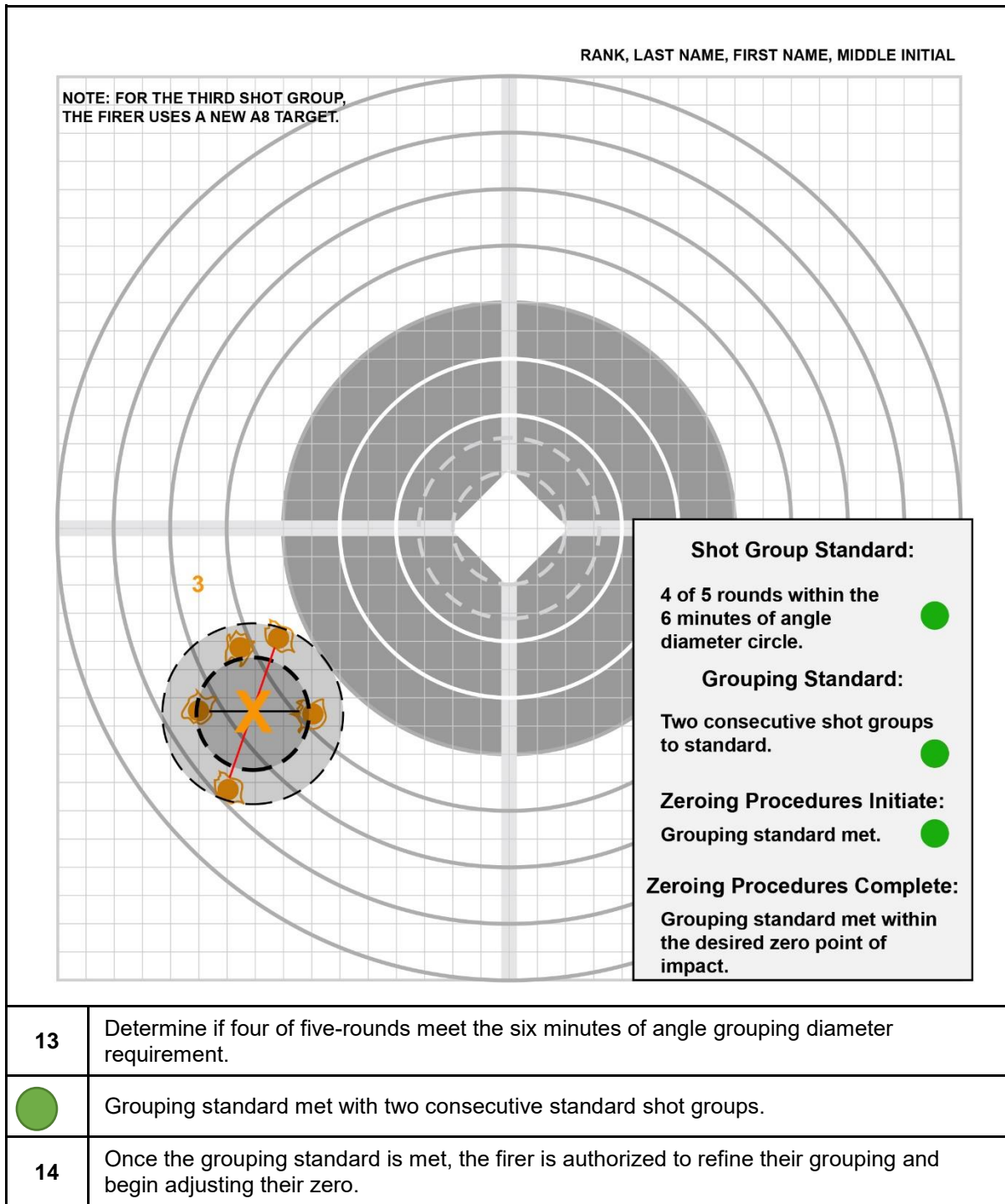

Figure F-9. Automatic rifle group 3 grouping standard determination

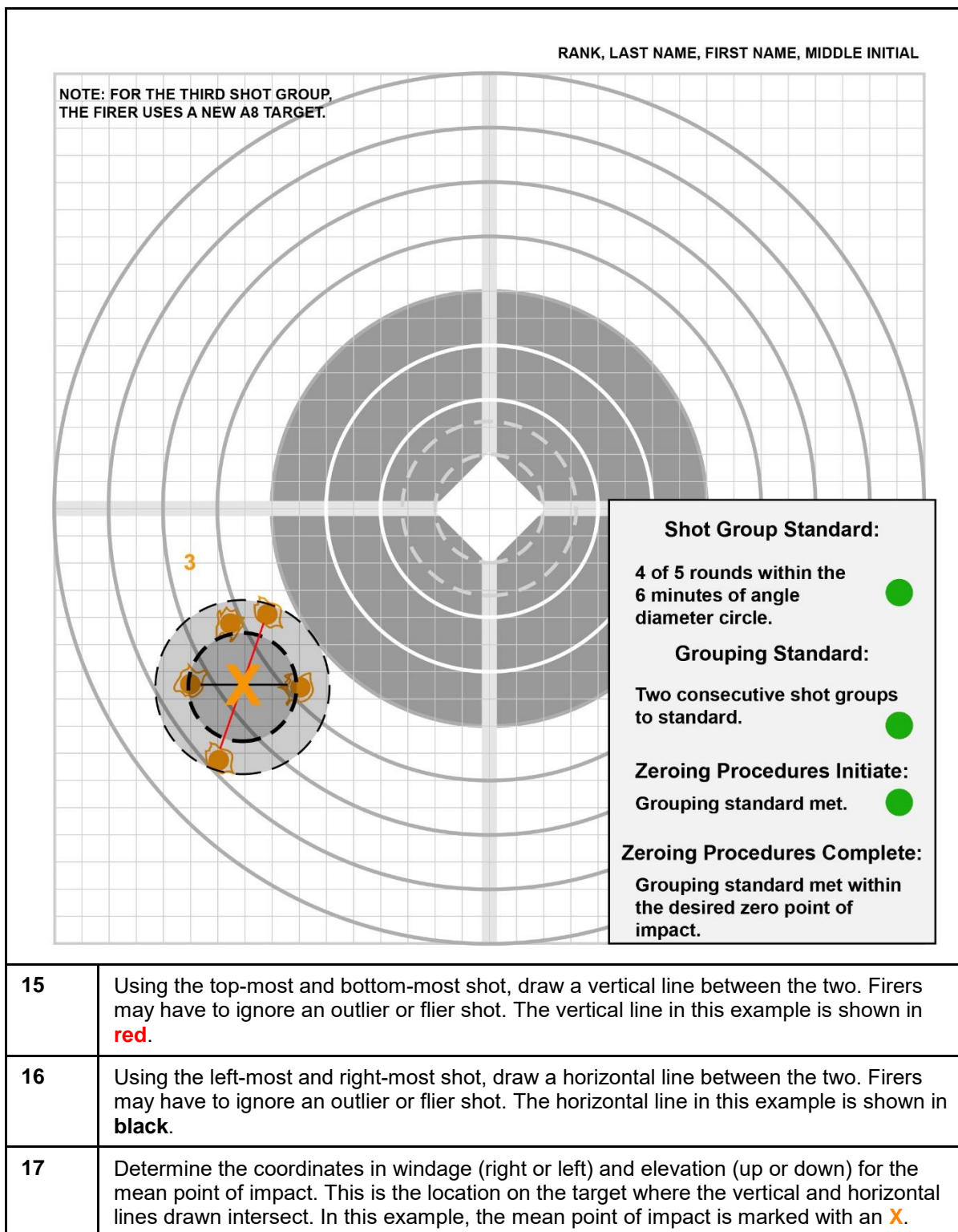

Figure F-10. Automatic rifle group 3 mean point of impact determination

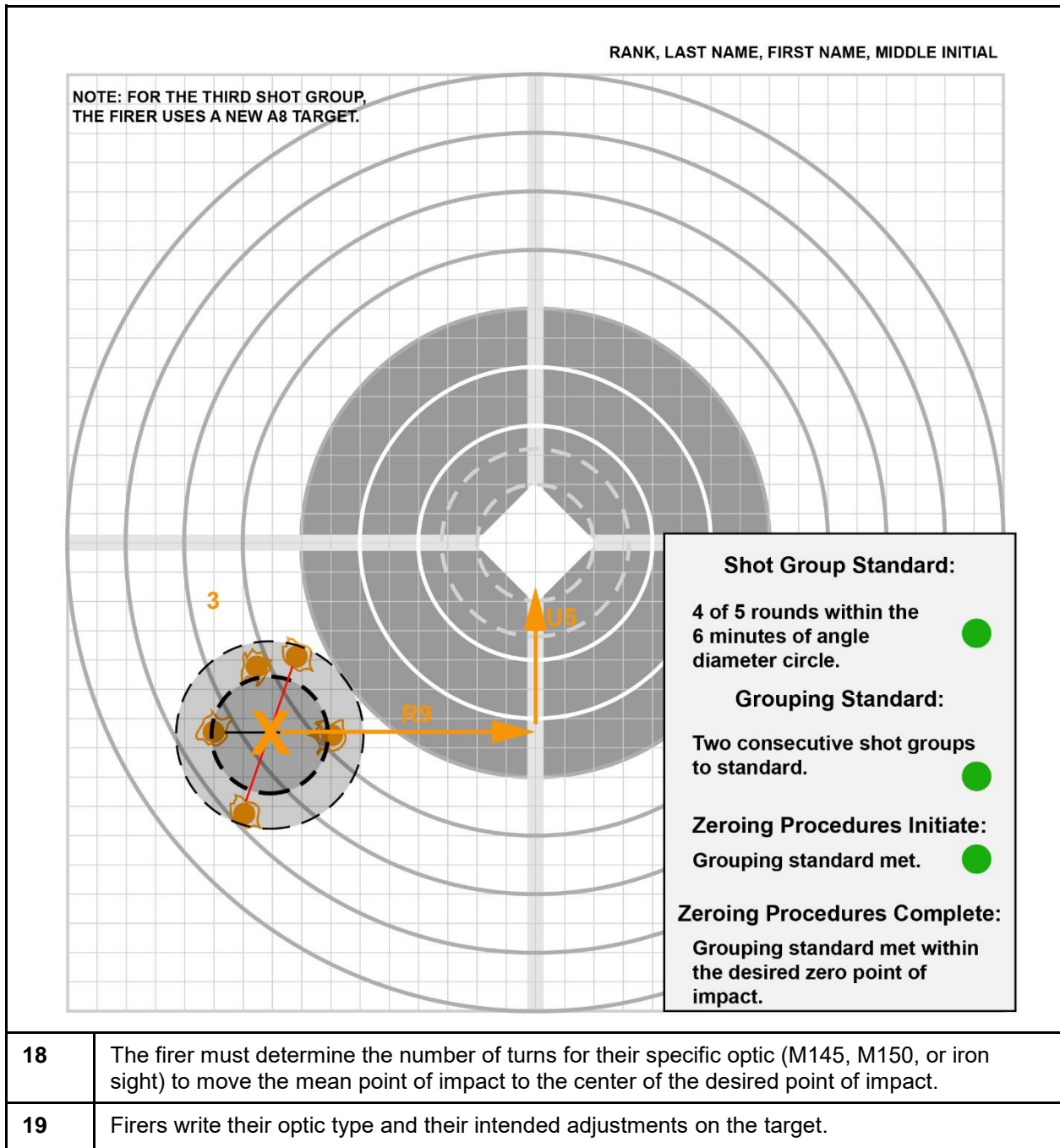

Figure F-11. Automatic rifle mean point of impact adjustment determination

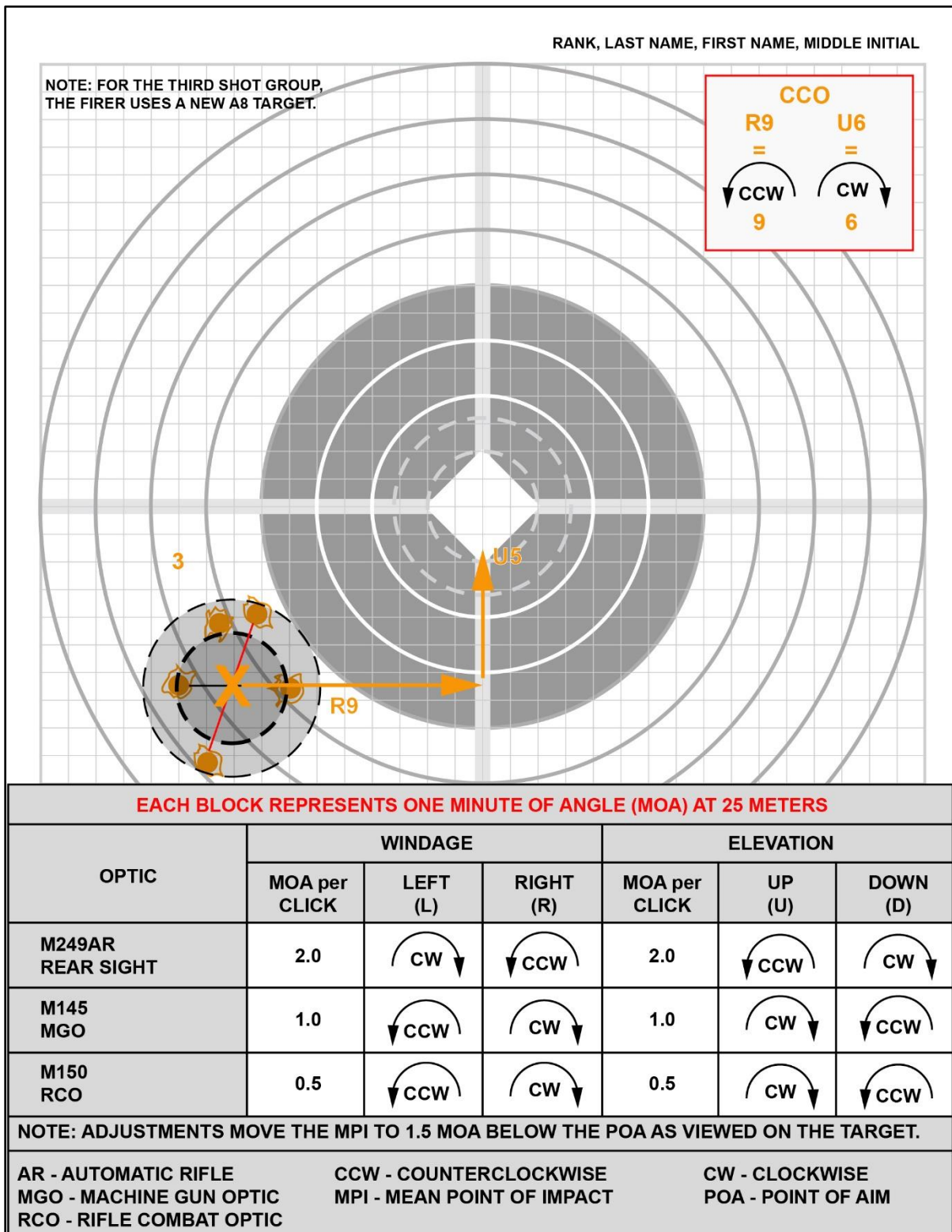

Figure F-12. Automatic rifle mean point of impact adjustment application

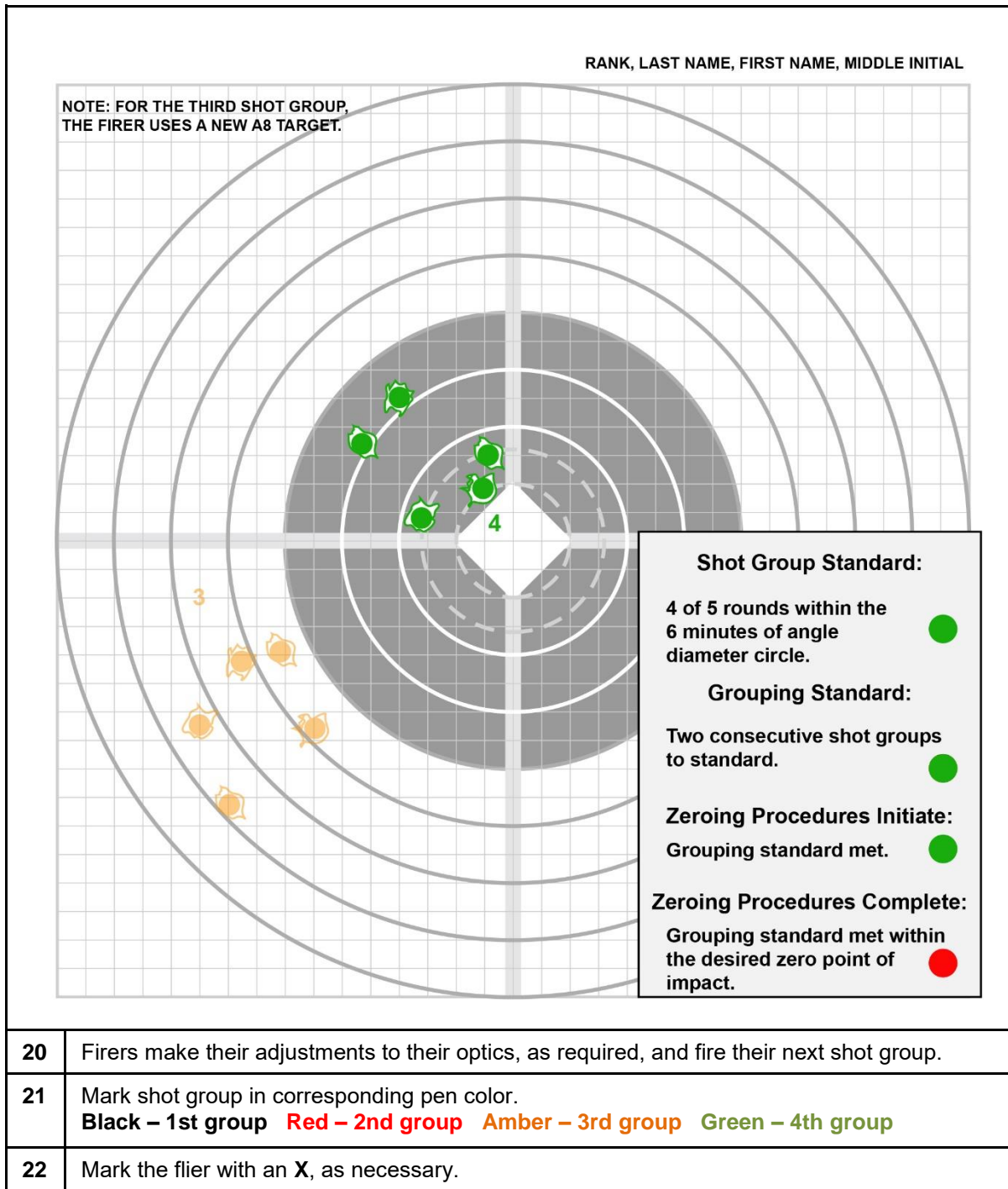

Figure F-13. Automatic rifle zero group 1

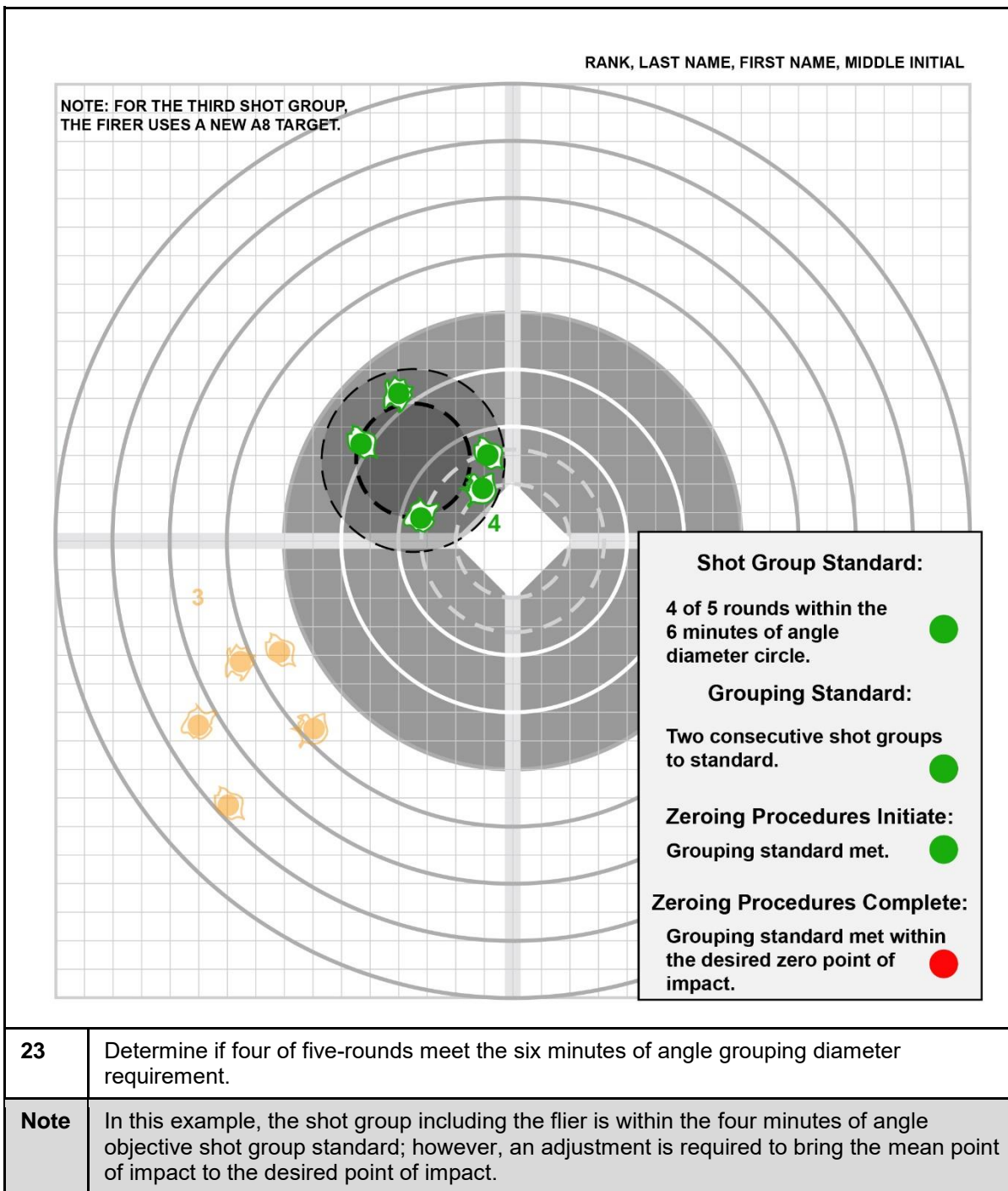

Figure F-14. Automatic rifle zero group 1 grouping standard determination

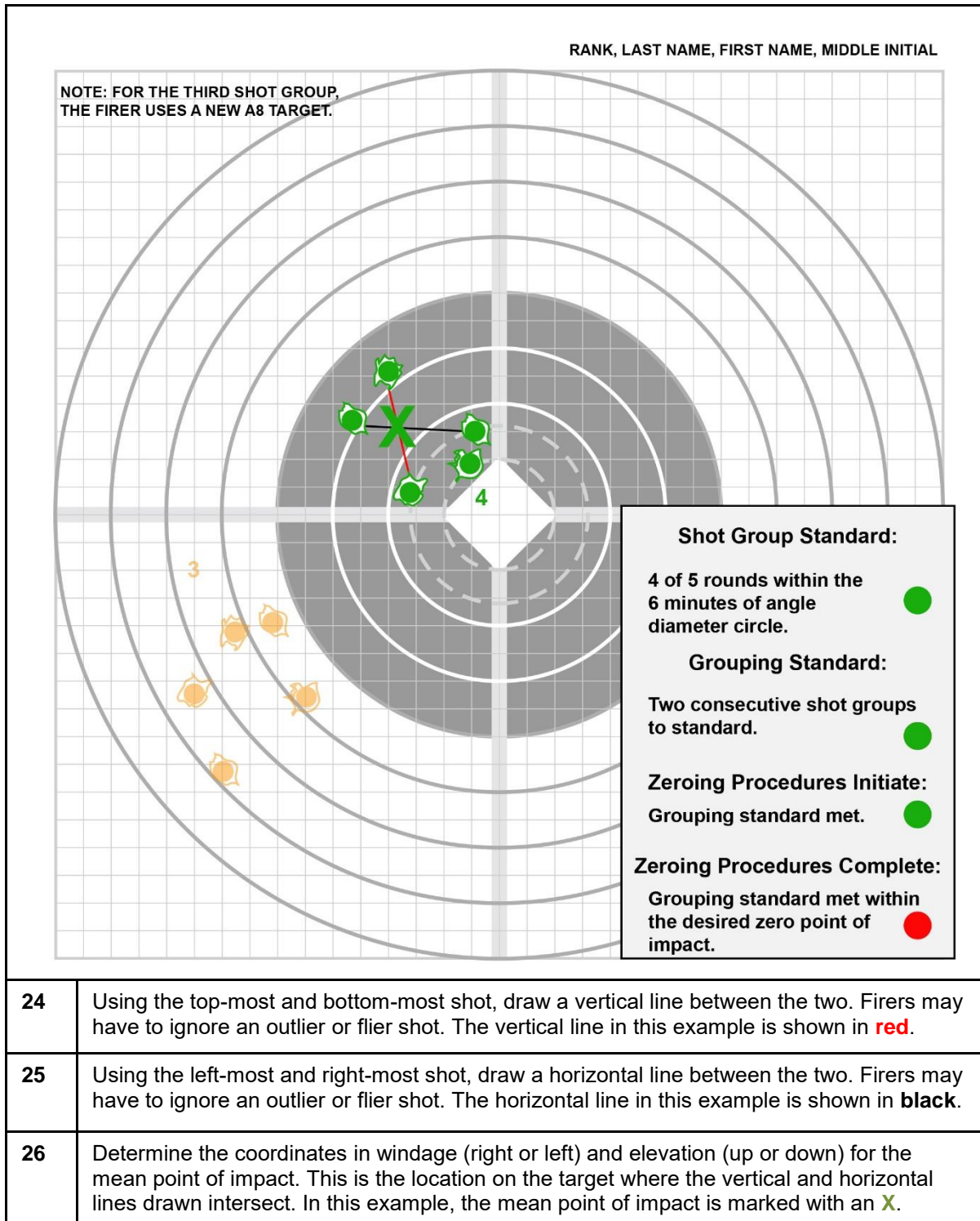

Figure F-15. Automatic rifle zero group 1 mean point of impact determination

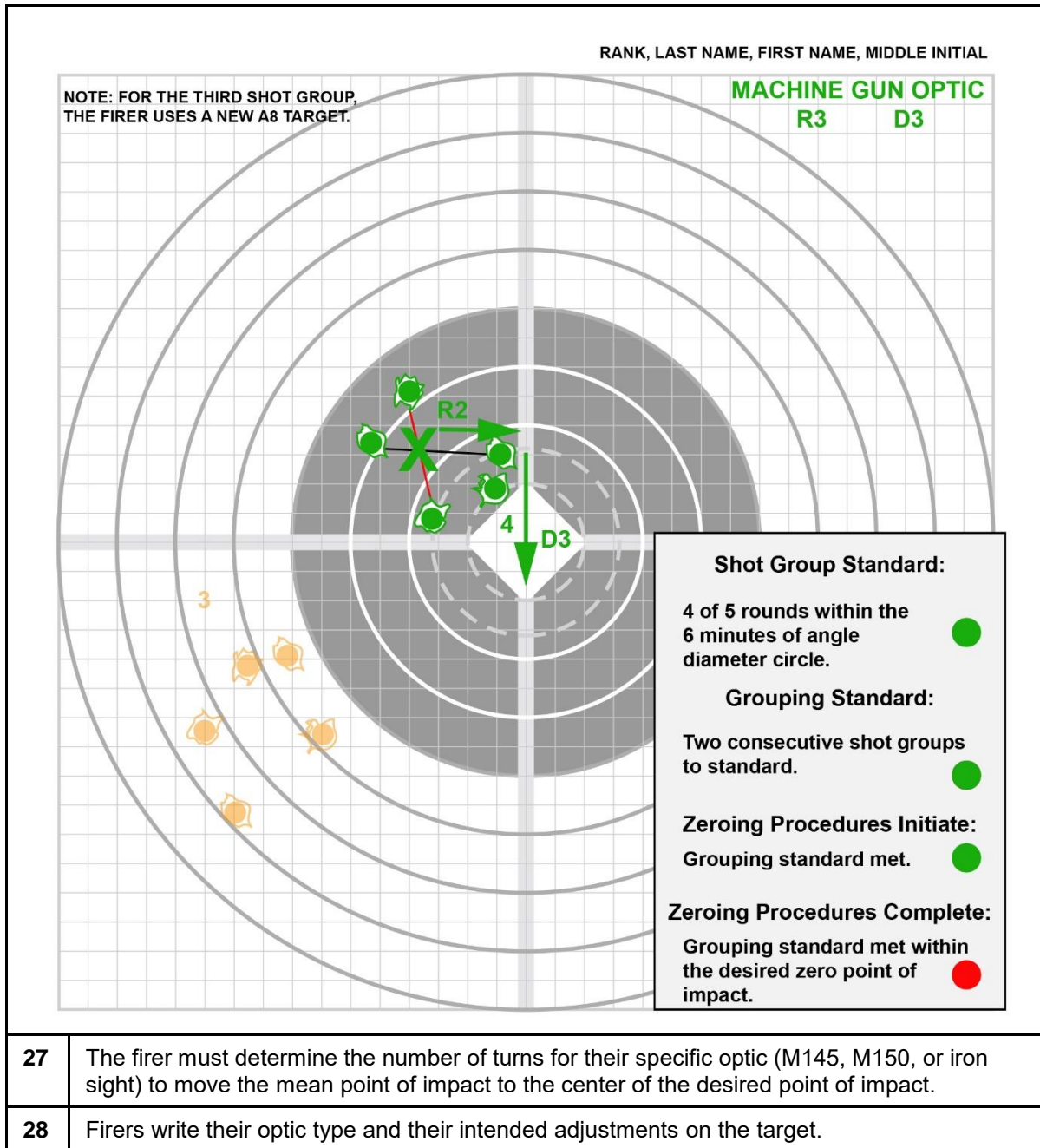

Figure F-16. Automatic rifle mean point of impact adjustment determination

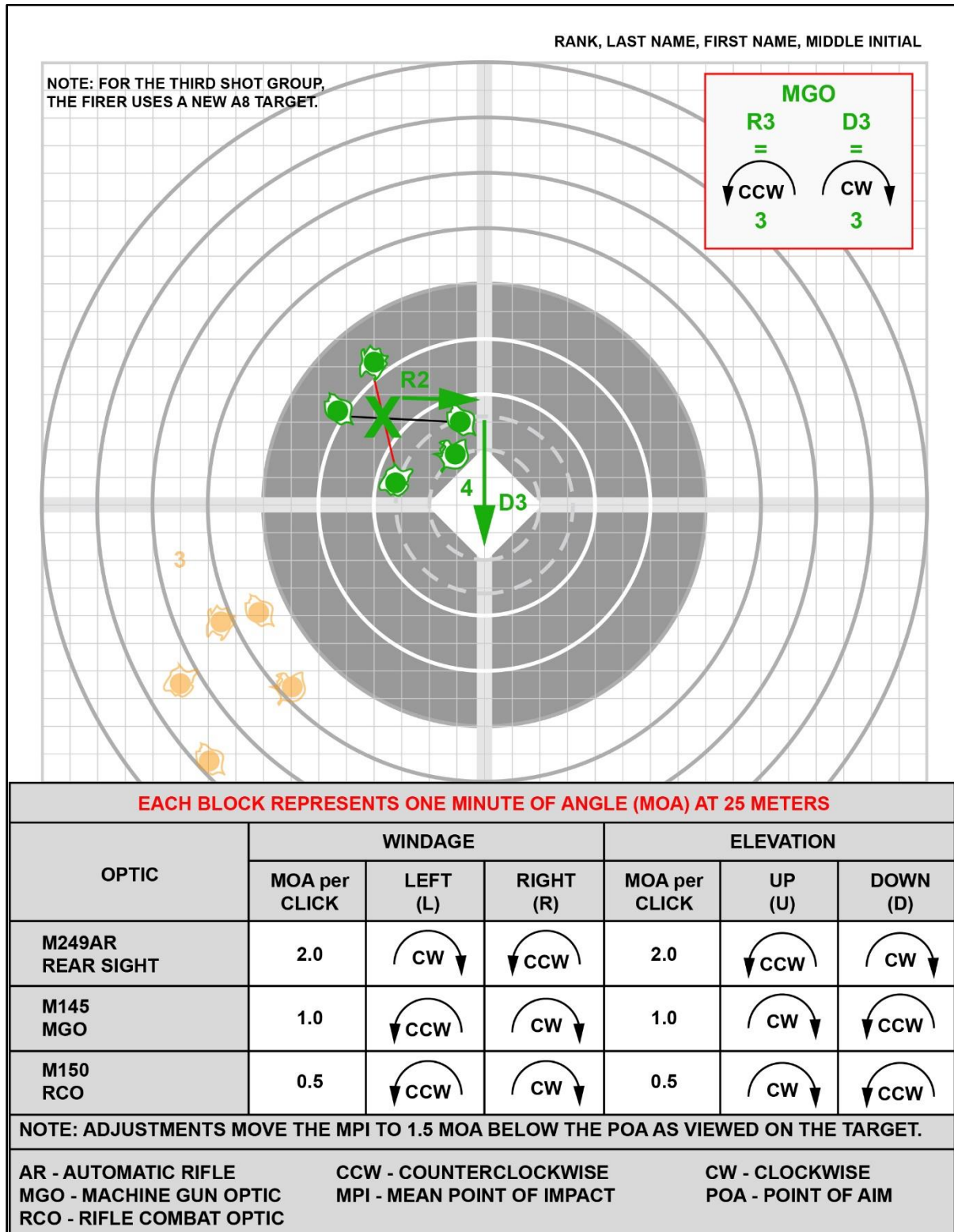

Figure F-17. Automatic rifle mean point of impact adjustment application

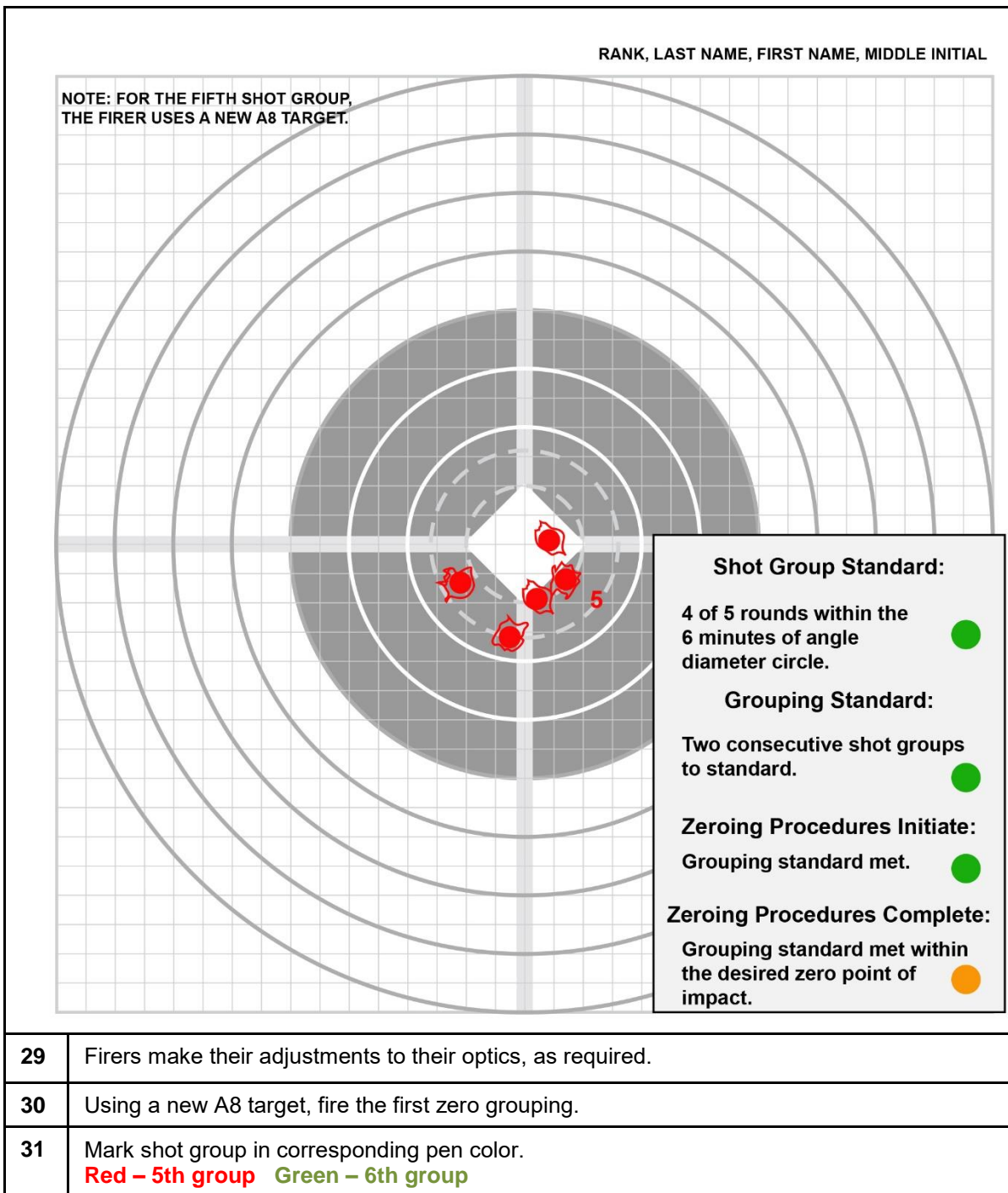

Figure F-18. Automatic rifle zero group

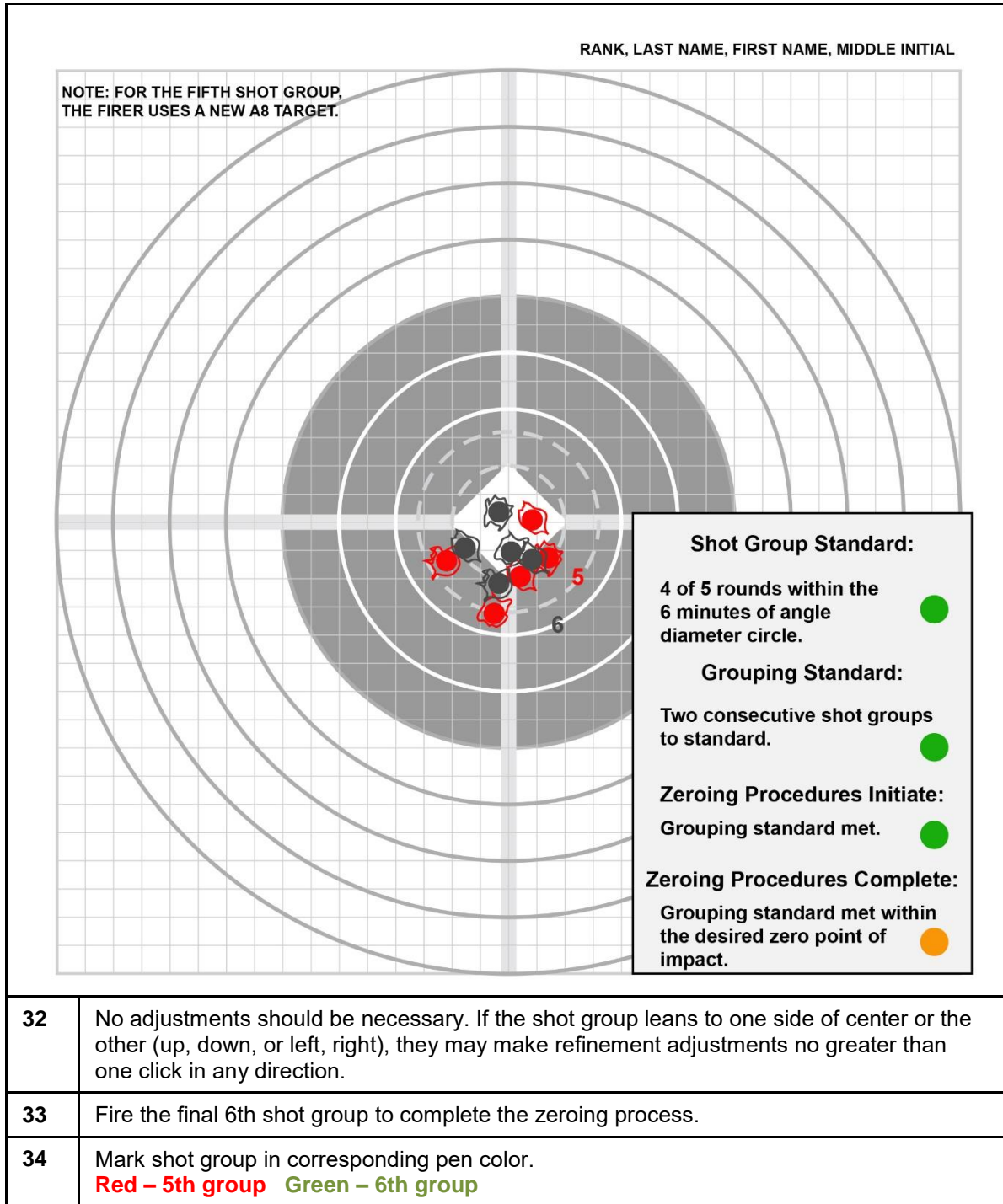

Figure F-19. Automatic rifle zero group 3

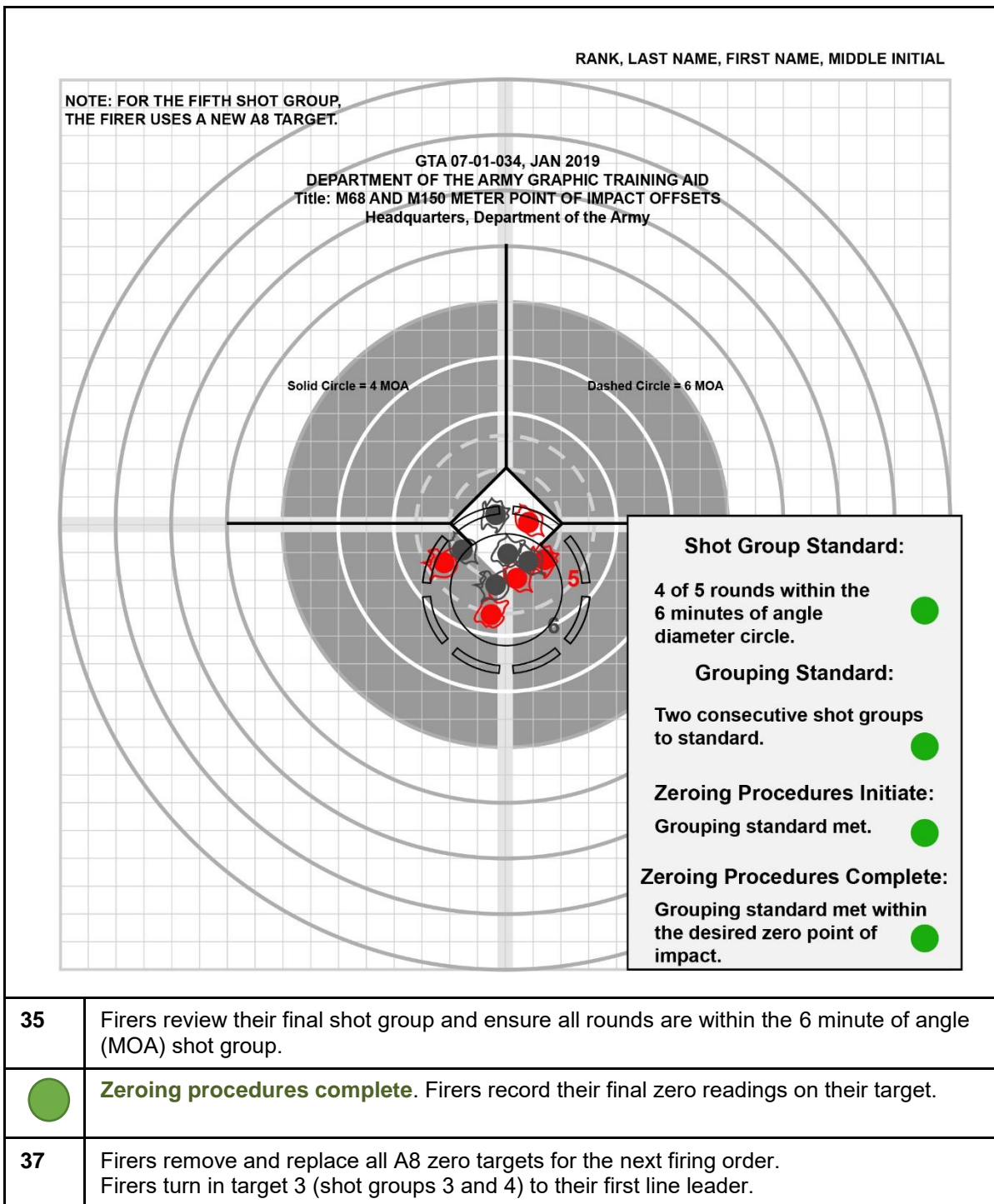
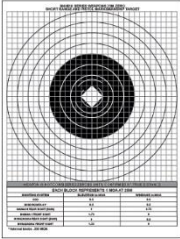
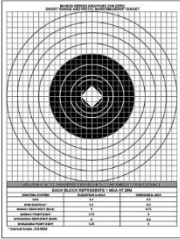
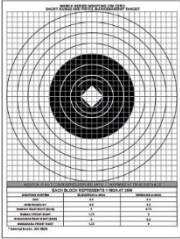

Figure F-20. Automatic rifle zero standard achieved

F-35. Soldiers begin Table IV tasks by moving into the firing position following administrative commands from the tower operator. Administrative commands control the flow of the range, movement of personnel, and other command and control purposes. Table F-22 provides an example of the administrative commands for moving a new firing order into position.

F-36. Soldiers enter the range and move to their firing points. Once at the firing point, firers assume a standing firing position with weapon in a green weapons safety status. Firers fire the tasks in Table IV from the prone supported position for each group.

Table F-22. Table IV, new firing order, conduct of the range example

| New Firing Order, Conduct of the Range | | | |
|--|---|--|--------------------------|
| 1 | 2 | 3 | |
|  |  |  | Task |
| | | | Target |
| | | | Target Type |
| | | | New Firing Order |
| | | | N/A |
| | | | N/A |
| | | | Rounds per Target |
| | | | DODIC |
| | | | Time (Seconds) |
| | | | N/A |
| | | | AB57 |
| | | | NO LIMIT |
| TOWER | | | SOLDIER ACTION |
| FIRERS ARE IN A GREEN STATUS | | | |
| CONDUCT OF THE RANGE | FIRING ORDER (ONE) — | | |
| | SECURE YOUR WEAPON AND AMMUNITION | Soldiers secure their magazines, ammunition, and then move to their designated firing point. | |
| | ONCE COMPLETE, MOVE TO YOUR FIRING POINT. | | |
| FIRERS ARE IN A GREEN STATUS | | | |
| Once all firers are at their FIRING POINT, the tower continues. | | | |
| Legend: DODIC – Department of Defense identification code, N/A – not applicable | | | |

Note. During any engagement a malfunction occurs, Soldiers must apply immediate action to their weapon then continue the engagement, as appropriate. Where immediate or remedial action does not correct the malfunction, Soldiers notify their respective lane safety.

F-37. As soon as the tower operator confirms all firers are at the appropriate firing point, the tower operator initiates the first engagement. Table F-23 lists the commands for the first engagement.

Table F-23. Table IV, engagement 1, first shot group, conduct of fire example

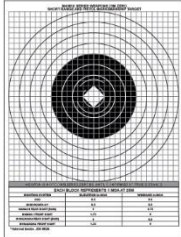
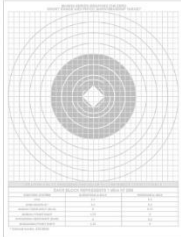
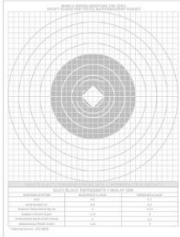
| Table IV, Engagement 1 – First Shot Group | | | | | |
|---|---|---|--|--------------|-----------------------|
| 1 | 2 | 3 | Group | Target | Target Type |
|  |  |  | 1 | A8 | Zero / Bull Ring |
| | | | Rounds per Engagement | DODIC | Time (Seconds) |
| | | | 5 | AB57 | NO LIMIT |
| TOWER | | | SOLDIER ACTION | | |
| WEAPONS SAFETY STATUS RED | | GO TO PRONE MAKE READY | Soldier moves to the PRONE supported position, establishes a good firing position, and loads a single-round magazine. | | |
| ALERT | FIRERS | | | | |
| TARGET DESCRIPTION | TARGET ONE | | Soldier acquires the designated A8 target. | | |
| DIRECTION | FRONT | | | | |
| RANGE | CLOSE QUARTERS | | Soldier acquires the target and identifies the target's point of aim (POA). | | |
| CONTROL | FIVE ROUNDS SLOW FIRE WEAPONS FREE WEAPONS FREE | | | | |
| EXECUTION | ENGAGE UPON POSITIVE IDENTIFICATION | | Soldier begins slow firing a five-round shot group, ensuring the same point of aim for each round. Firers reload single-round magazines at their own pace. | | |
| TOWER AWAITS ALL FIRERS TO COMPLETE THE FIVE-ROUND GROUP | | | | | |
| TERMINATION | CEASE FIRE CEASE FIRE | | The firer's BOLT should be locked to the rear. Tower must assume all weapons are RED. | | |
| WEAPONS SAFETY STATUS GREEN | | GO GREEN SHOW CLEAR | Soldiers clear their weapons, show clear to the lane safety. | | |
| Once all firers are complete, the tower directs: MOVE TO THE TARGET AND REVIEW YOUR SHOT GROUP. ONCE COMPLETE, RETURN TO THE FIRING POINT. | | | | | |
| Legend: DODIC – Department of Defense identification code | | | | | |

F-38. Once all firers have completed the first group, the firer and coach analyze the group to determine if improvements to the firers shot process are required. They mark the group prior to returning to the firing line. After all firers have returned from downrange, the tower operator prepares for engagement 2, shown in table F-24. The tower operator’s initial command initiates the firer to GO TO PRONE and MAKE READY.

Table F-24. Table IV, engagement 2, second shot group, conduct of fire example

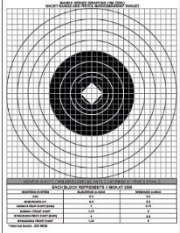
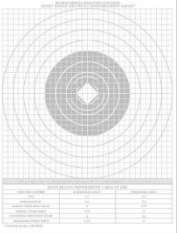
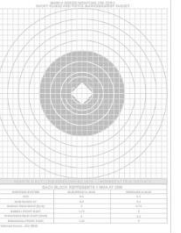
| Table IV, Engagement 2 – Second Shot Group | | | |
|---|---|---|--|
| 1 | 2 | 3 | |
|  |  |  | |
| | | | Group |
| | | | Target |
| | | | Target Type |
| | | | 2 |
| | | | A8 |
| | | | Zero / Bull Ring |
| | | | Rounds per Engagement |
| | | | DODIC |
| | | | Time (Seconds) |
| | | | 5 |
| | | | AB57 |
| | | | NO LIMIT |
| TOWER | | | SOLDIER ACTION |
| WEAPONS SAFETY STATUS RED | | GO TO PRONE MAKE READY | Soldier moves to the PRONE supported position, establishes a good firing position, and loads a single-round magazine. |
| ALERT | FIRERS | | |
| TARGET DESCRIPTION | TARGET ONE | | Soldier acquires the designated A8 target. |
| DIRECTION | FRONT | | |
| RANGE | CLOSE QUARTERS | | Soldier acquires the target and identifies the target's point of aim (POA). |
| CONTROL | FIVE ROUNDS SLOW FIRE WEAPONS FREE WEAPONS FREE | | |
| EXECUTION | ENGAGE UPON POSITIVE IDENTIFICATION | | Soldier begins slow firing a five-round shot group, ensuring the same point of aim for each round. Firers reload single-round magazines at their own pace. |
| TOWER AWAITS ALL FIRERS TO COMPLETE THE FIVE-ROUND GROUP | | | |
| TERMINATION | CEASE FIRE CEASE FIRE | | The firer's BOLT should be locked to the rear. Tower must assume all weapons are RED. |
| WEAPONS SAFETY STATUS GREEN | | GO GREEN SHOW CLEAR | Soldiers clear their weapons, show clear to the lane safety. |
| Once all firers are complete, the tower directs: MOVE TO THE TARGET AND REVIEW YOUR SHOT GROUP. ONCE COMPLETE, RETURN TO THE FIRING POINT. | | | |
| Legend: DODIC – Department of Defense identification code | | | |

F-39. After completing the second group, the firer and coach analyze the group to determine if improvements to the firers shot process are required and mark the group. Firers that successfully demonstrate the ability to group, determine required adjustments and apply them to the aiming device. After all firers have returned to the firing line, the tower operator prepares for engagement 3 (see table F-25.)

Table F-25. Table IV, engagement 3, third shot group, conduct of fire example

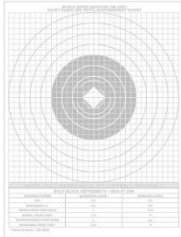
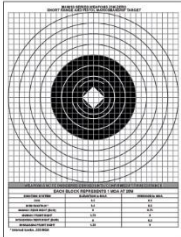
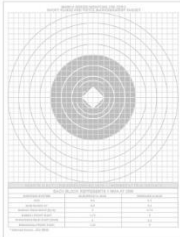
| <i>Table IV, Engagement 3 – Third Shot Group</i> | | | | | |
|---|---|---|--|--------------|-----------------------|
| 1 | 2 | 3 | Group | Target | Target Type |
|  |  |  | 3 | A8 | Zero / Bull Ring |
| | | | Rounds per Engagement | DODIC | Time (Seconds) |
| | | | 5 | AB57 | NO LIMIT |
| TOWER | | | SOLDIER ACTION | | |
| WEAPONS SAFETY STATUS RED | | GO TO PRONE MAKE READY | Soldier moves to the PRONE supported position, establishes a good firing position, and loads one single-round magazine. | | |
| ALERT | FIRERS | | | | |
| TARGET DESCRIPTION | TARGET TWO | | Soldier acquires the designated A8 target. | | |
| DIRECTION | FRONT | | | | |
| RANGE | CLOSE QUARTERS | | Soldier acquires the target and identifies the target's point of aim (POA). | | |
| CONTROL | FIVE ROUNDS SLOW FIRE WEAPONS FREE WEAPONS FREE | | | | |
| EXECUTION | ENGAGE UPON POSITIVE IDENTIFICATION | | Soldier begins slow firing a five-round shot group, ensuring the same point of aim for each round. Firers reload single-round magazines at their own pace. | | |
| TOWER AWAITS ALL FIRERS TO COMPLETE THE FIVE-ROUND GROUP | | | | | |
| TERMINATION | CEASE FIRE CEASE FIRE | | The firer's BOLT should be locked to the rear. Tower must assume all weapons are RED. | | |
| WEAPONS SAFETY STATUS GREEN | GO GREEN SHOW CLEAR | | Soldiers clear their weapons, show clear to the lane safety. | | |
| Once all firers are complete, the tower directs: MOVE TO THE TARGET AND REVIEW YOUR SHOT GROUP. ONCE COMPLETE, RETURN TO THE FIRING POINT. | | | | | |
| Legend: DODIC – Department of Defense identification code | | | | | |

F-40. Once all firers have completed the third group, annotated the appropriate adjustments on their target, and applied the adjustments to their weapon or optic, the tower operator prepares for engagement 4, shown in table F-26. Leaders should remove Soldiers who have not demonstrated the ability to group from the firing line and direct them to the appropriate area to receive remedial training.

Table F-26. Table IV, engagement 4, group one, conduct of fire example

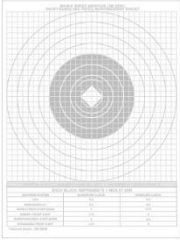
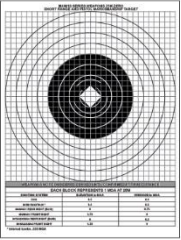
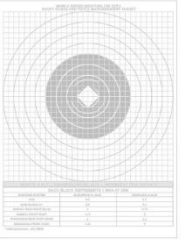
| Table IV, Engagement 4 –Group One | | | | | |
|---|---|---|--|--------|------------------|
| 1 | 2 | 3 | Group | Target | Target Type |
|  |  |  | 4 | A8 | Zero / Bull Ring |
| | | | Rounds per Engagement | DODIC | Time (Seconds) |
| | | | 5 | AB57 | NO LIMIT |
| TOWER | | | SOLDIER ACTION | | |
| WEAPONS SAFETY STATUS RED | | GO TO PRONE MAKE READY | Soldier moves to the PRONE supported position, establishes a good firing position, and loads one single-round magazine. | | |
| ALERT | FIRERS | | | | |
| TARGET DESCRIPTION | TARGET TWO | | Soldier acquires the designated A8 target. | | |
| DIRECTION | FRONT | | | | |
| RANGE | CLOSE QUARTERS | | Soldier acquires the target and identifies the target's point of aim (POA). | | |
| CONTROL | FIVE ROUNDS SLOW FIRE WEAPONS FREE WEAPONS FREE | | | | |
| EXECUTION | ENGAGE UPON POSITIVE IDENTIFICATION | | Soldier begins slow firing a five-round shot group, ensuring the same point of aim for each round. Firers reload single-round magazines at their own pace. | | |
| TOWER AWAITS ALL FIRERS TO COMPLETE THE FIVE-ROUND GROUP | | | | | |
| TERMINATION | CEASE FIRE CEASE FIRE | | The firer's BOLT should be locked to the rear. Tower must assume all weapons are RED. | | |
| WEAPONS SAFETY STATUS GREEN | | GO GREEN SHOW CLEAR | Soldiers clear their weapons, show clear to the lane safety. | | |
| Once all firers are complete, the tower directs: MOVE TO THE TARGET AND REVIEW YOUR SHOT GROUP. ONCE COMPLETE, RETURN TO THE FIRING POINT. | | | | | |
| Legend: DODIC – Department of Defense identification code | | | | | |

F-41. Once all firers have completed the first zeroing group, annotated the appropriate adjustments on their target, and applied the adjustments to their weapon or optic, the tower operator prepares for engagement 5, shown in table F-27.

Table F-27. Table IV, engagement 5, zeroing group two, conduct of fire example

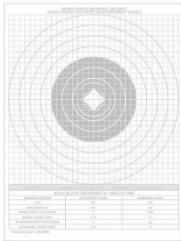
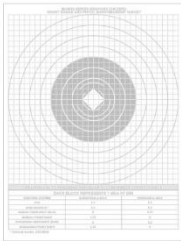
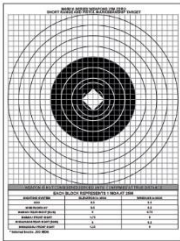
| <i>Table IV, Engagement 5 – Zeroing Group Two</i> | | | | | |
|---|---|---|--|--------------|-----------------------|
| 1 | 2 | 3 | Zeroing Group | Target | Target Type |
|  |  |  | 1 | A8 | Zero / Bull Ring |
| | | | Rounds per Engagement | DODIC | Time (Seconds) |
| | | | 5 | AB57 | NO LIMIT |
| TOWER | | | SOLDIER ACTION | | |
| WEAPONS SAFETY STATUS RED | | GO TO PRONE MAKE READY | Soldier moves to the PRONE supported position, establishes a good firing position, and loads one single-round magazine. | | |
| ALERT | FIRERS | | | | |
| TARGET DESCRIPTION | TARGET THREE | | Soldier acquires the designated A8 target. | | |
| DIRECTION | FRONT | | | | |
| RANGE | CLOSE QUARTERS | | Soldier acquires the target and identifies the target's point of aim (POA). | | |
| CONTROL | FIVE ROUNDS SLOW FIRE WEAPONS FREE WEAPONS FREE | | | | |
| EXECUTION | ENGAGE UPON POSITIVE IDENTIFICATION | | Soldier begins slow firing a five-round shot group, ensuring the same point of aim for each round. Firers reload single-round magazines at their own pace. | | |
| TOWER AWAITS ALL FIRERS TO COMPLETE THE FIVE-ROUND GROUP | | | | | |
| TERMINATION | CEASE FIRE CEASE FIRE | | The firer's BOLT should be locked to the rear. Tower must assume all weapons are RED. | | |
| WEAPONS SAFETY STATUS GREEN | GO GREEN SHOW CLEAR | | Soldiers clear their weapons, show clear to the lane safety. | | |
| Once all firers are complete, the tower directs: MOVE TO THE TARGET AND REVIEW YOUR SHOT GROUP. ONCE COMPLETE, RETURN TO THE FIRING POINT. | | | | | |
| Legend: DODIC – Department of Defense identification code | | | | | |

F-42. Once all firers have completed zeroing group two, annotated the appropriate adjustments on their target, and applied the adjustments to their weapon or optic, the tower operator prepares for engagement 6, shown in table F-28. The tower operator’s initial command initiates the firer to GO TO PRONE and MAKE READY.

Table F-28. Table IV, engagement 6, zeroing group three, conduct of fire example

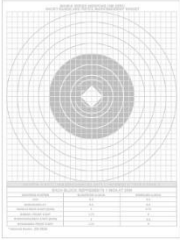
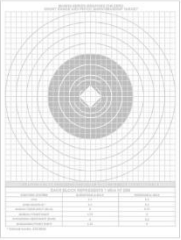
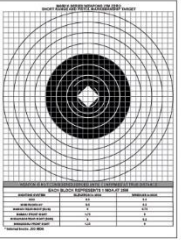
| <i>Table IV, Engagement 6 – Zeroing Group Three</i> | | | | | |
|---|---|---|--|--------|------------------|
| 1 | 2 | 3 | Zeroing Group | Target | Target Type |
|  |  |  | 2 | A8 | Zero / Bull Ring |
| | | | Rounds per Engagement | DODIC | Time (Seconds) |
| | | | 5 | AB57 | NO LIMIT |
| TOWER | | | SOLDIER ACTION | | |
| WEAPONS SAFETY STATUS RED | | GO TO PRONE MAKE READY | Soldier moves to the PRONE supported position, establishes a good firing position, and loads one single-round magazine. | | |
| ALERT | FIRERS | | | | |
| TARGET DESCRIPTION | TARGET THREE | | Soldier acquires the designated A8 target. | | |
| DIRECTION | FRONT | | | | |
| RANGE | CLOSE QUARTERS | | Soldier acquires the target and identifies the target’s point of aim (POA). | | |
| CONTROL | FIVE ROUNDS SLOW FIRE WEAPONS FREE WEAPONS FREE | | | | |
| EXECUTION | ENGAGE UPON POSITIVE IDENTIFICATION | | Soldier begins slow firing a five-round shot group, ensuring the same point of aim for each round. Firers reload single-round magazines at their own pace. | | |
| TOWER AWAITS ALL FIRERS TO COMPLETE THE FIVE-ROUND GROUP | | | | | |
| TERMINATION | CEASE FIRE CEASE FIRE | | The firer’s BOLT should be locked to the rear. Tower must assume all weapons are RED. | | |
| WEAPONS SAFETY STATUS GREEN | | GO GREEN SHOW CLEAR | Soldiers clear their weapons, show clear to the lane safety. | | |
| Once all firers are complete, the tower directs: MOVE TO THE TARGET, REVIEW YOUR SHOT GROUP, REMOVE TARGETS AND REPLACE WITH FRESH TARGETS. ONCE COMPLETE, RETURN TO THE FIRING POINT. | | | | | |
| Legend: DODIC – Department of Defense identification code | | | | | |

F-43. Once all firers have recovered their targets and placed fresh A8 targets on the target frame, firers collect their brass, ammunition, magazines, and dunnage from their firing position after which the lane safety clears them. Once this action is completed, the lane safety communicates the WSS to the tower operator and the tower operator issues an administrative command moving the Soldiers off the range.

F-44. The tower operator may direct certain firers to remain on the firing point, as necessary. Those firers include Soldiers assigned both iron sights and primary optic. They must zero the secondary aiming device. Those Soldiers require additional ammunition to complete the requisite tasks.

F-45. During the range reconnaissance, the unit determines if the 25-meter target frame interferes with the firer's ability to acquire and engage the zero confirmation target. Where the 25-meter target frame presents a line-of-sight issue to the zero confirmation target, units should bypass the confirmation process. When the zero confirmation target cannot be safely or effectively used with the 25-meter target frame emplaced, units conduct confirmation at distance (one each, five-round short belt) by—

- Completing all firing orders through grouping and zeroing tasks, then remove the target frames from the range while in a cold or dry status.
- Complete the confirmation at distance task prior to conducting Table V tasks (when using a separate facility).

F-46. Table F-29 on page F-48, provides the conduct of fire for stage 3 and stage 4. All firers must have completed making adjustments to their aiming devices and recorded their final zero information for their weapon and optic prior to confirming at distance or applying hold-offs to the 100-meter and 200-meter target. All weapons are initially in a green status.

Table F-29. Table IV, engagement 7, confirmation at distance, conduct of fire example

| <i>Table IV, Engagement 7 – Zero Confirmation at Distance</i> | | | |
|---|--|--|-------------------------------------|
|  <p>300 meter (Unit may select different zero range based on their SOP, TTP, or mission requirements).</p> | Zero Confirmation | Target | Target Type |
| | 1 | E-1 or D-1 | Silhouette, kneeling (hit-bob mode) |
| | Rounds per Engagement | DODIC | Time (Seconds) |
| | 5 | AB56 | NO LIMIT |
| TOWER | | SOLDIER ACTION | |
| WEAPONS SAFETY STATUS RED | GO TO PRONE MAKE READY | Soldier moves to the PRONE supported position, establishes a good firing position, and loads one single round magazine. | |
| ALERT | FIRERS | | |
| TARGET DESCRIPTION | TROOP | Soldier acquires the zero confirmation target. | |
| DIRECTION | FRONT | | |
| RANGE | THREE-HUNDRED | Soldier acquires the target and identifies the target's center of visible mass (known as CoVM). | |
| CONTROL | FIVE ROUNDS SLOW FIRE WEAPONS FREE WEAPONS FREE | | |
| EXECUTION | ENGAGE UPON POSITIVE IDENTIFICATION | Soldier begins slow firing a five-round shot group, ensuring the same point of aim for each round. | |
| ONCE ALL FIRERS ARE COMPLETE WITH THE FIVE-ROUND CONFIRMATION AT DISTANCE: | | | |
| TERMINATION | CEASE FIRE CEASE FIRE | The firer's BOLT should be locked to the rear. Tower must assume all weapons are RED. | |
| WEAPONS SAFETY STATUS GREEN | GO GREEN SHOW CLEAR | Soldiers clear their weapons, show clear to the lane safety. | |
| Firer's should achieve four of five hits to successfully complete confirmation at distance. The tower should identify any firer that has not met the confirmation standard and move those Soldiers to the retraining location. | | | |
| Legend: DODIC – Department of Defense identification code, SOP – standard operating procedure, TTP – tactics, techniques, and procedures | | | |

F-47. Once all firers have completed stage 3, they remain in place and await further instructions from the tower operator. The tower operator instructs them to reload and prepare for stage 4. Table F-30 shows an example of the conduct of fire for Table IV, Stage 4.

Table F-30. Table IV, engagement 8, application of hold-offs, conduct of fire example

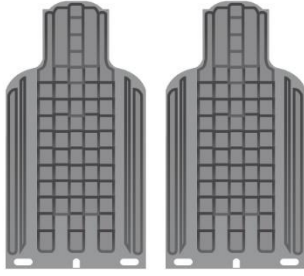
| <i>Table IV, Engagement 8 – Application of Hold-Offs</i> | | | |
|---|--|--|-------------------------------------|
|  <p>100 and 200 meter</p> | Application of Hold-Offs | Target | Target Type |
| | 1 | E-1 or D-1 | Silhouette, kneeling (hit-bob mode) |
| | Rounds per Engagement | DODIC | Time (Seconds) |
| | 10 | AB57 | 55 |
| TOWER | | SOLDIER ACTION | |
| WEAPONS SAFETY STATUS RED | MAKE READY | Soldier remains in the PRONE supported position, establishes a good firing position, and loads one single round magazine. | |
| ALERT | FIRERS | | |
| TARGET DESCRIPTION | TROOPS | Soldier acquires the 100 meter target. | |
| DIRECTION | FRONT | | |
| RANGE | ONE-HUNDRED AND TWO HUNDRED | Soldier acquires the target and identifies the target's center of visible mass (known as CoVM). | |
| CONTROL | FIVE ROUNDS SLOW FIRE WEAPONS FREE WEAPONS FREE | | |
| EXECUTION | ENGAGE UPON POSITIVE IDENTIFICATION | Soldier begins slow firing a five-round shot group, applying the appropriate hold-off at the 100 meter target and again at the 200 meter target. | |
| ONCE ALL FIRERS ARE COMPLETE WITH THE 10-ROUND APPLICATION OF HOLD-OFF: | | | |
| TERMINATION | CEASE FIRE CEASE FIRE | The firer's BOLT should be locked to the rear. Tower must assume all weapons are RED. | |
| WEAPONS SAFETY STATUS GREEN | GO GREEN SHOW CLEAR | Soldiers clear their weapons, show clear to the lane safety. | |
| Firer's should achieve four of five hits on each target to successfully complete application of hold-offs. The tower should identify any firer that has not met the standard and move those Soldiers to the retraining location. | | | |
| Legend: DODIC – Department of Defense identification code, SOP – standard operating procedure, TTP – tactics, techniques, and procedures, | | | |

F-48. Once all firers have been verified green by the lane safety, the tower operator directs the firing order off the baseline. The tower must identify Soldiers who have failed to achieve the confirmation at distance standard (4 of 5 hits at zeroing distance) and move those Soldiers to a predetermined retraining location.

F-49. Table F-31 provides a generic example of the conduct of the range instructions to change firing orders. All firers on the range are in a green status.

Table F-31. Table IV, completed firing order, conduct of the range example

| Completed Firing Order, Conduct of the Range | | | |
|---|---|-----------------------|---|
| FIRING ORDER COMPLETE | Task | Target | Target Type |
| | Completed Firing Order | N/A | N/A |
| | Rounds per Target | DODIC | Time (Seconds) |
| | N/A | N/A | NO LIMIT |
| TOWER | | SOLDIER ACTION | |
| FIRERS ARE IN A GREEN STATUS | | | |
| CONDUCT OF THE RANGE | <p>SECURE YOUR DUNNAGE, MAGAZINES, AND AMMUNITION</p> <p>ONCE SET, MOVE TO THE BASELINE ENTRY CONTROL POINT</p> | | <p>Firers secure weapon and ammunition dunnage and move to the designated location.</p> |
| ONCE ALL FIRERS HAVE EXITED THROUGH THE BASELINE ENTRY CONTROL POINT, THE TOWER DIRECTS THE MOVEMENT OF THE NEXT FIRING ORDER. | | | |
| Legend: DODIC – Department of Defense identification code, N/A – not applicable | | | |

F-50. Leaders review the shot groups with their Soldiers and collect their grouping and zeroing targets for an AAR and verification of zeroing data. Leaders should maintain a record of the zeroing information, and review the targets for any firer errors during the shot process.

F-51. The tower operator records the completion of the firing order in the tower log and includes the number of Soldiers trained. This information is tabulated at the end of the firing day to change the firing status of the range to a cold and dry status with range operations.

AUTOMATIC RIFLE, TABLE V, PRACTICE

F-52. Table V, Practice is a practice table to use in preparation for the qualification course of fire. Table V tasks challenge firers with single and multiple stationary targets between 50- and 300-meters, from the prone unsupported, prone supported, kneeling supported, and standing supported firing positions. Leaders use Table V to train the firer to engage single and multiple targets placed in a tactical array using their primary optic and apply the functional elements of the shot process.

F-53. In a timed scenario, the firer experiences and learns target prioritization and weapons manipulation. This event is purposely more rigorous than the qualification event where the targets are presented in a rapid tempo, and the time to transition between firing positions and tactical reloading are reduced. The practice event also induces a notional malfunction requiring the firer to use one or two magazines rather than belted ammunition. This trains the firer to change ammunition feed sources in an emergency situation to defeat

several threats. It reinforces their ability to load belted ammunition, followed by magazine fed ammunition, and returning to belted ammunition.

F-54. Leaders conduct Table V tasks on an ARF or comparable range facility. This course of fire is specifically designed to be interoperable with the Rifle and Carbine, Table V elements. This allows the conduct of multiple types of individual weapons training on the same facility simultaneously, using the same target scenario.

TASK, CONDITIONS, AND STANDARD

F-55. Table F-32 outlines the tasks, conditions, and standards for the conduct of Table V tasks. The firer conducting the event should know the tasks, conditions, and standards and should explain them during the range briefing conduct.

Table F-32. Automatic Rifle, Table V, Practice

| | |
|--------------------|---|
| Task: | Engage and defeat single and multiple threats at varying ranges from supported or unsupported standing, kneeling, and prone firing positions, during day and limited visibility conditions using ball ammunition. |
| Conditions: | Given the following: <ul style="list-style-type: none"> • Fully mission capable weapon as assigned on the master authorization list for the unit. • Full combat uniform, issued equipment, and protective mask. • Authorized range facility. • Full-scale, approved targetry in standard scenario engagement sequences. • Authorized ammunition. |
| Standard: | Demonstrate engagement proficiency by hitting 70 percent (28 of 40) of all presented targets in the time allotted. |

F-56. Table F-33, on page F-52, shows the training event design template for Automatic Rifle, Table V, Practice. Leaders conduct this event on an authorized live-fire facility, typically an ARF or comparable range facility. See TC 25-8 for additional information on authorized range facilities.

Table F-33. Automatic Rifle, Table V, Practice ammunition requirements

| <i>Automatic Rifle, Table V, Practice</i> | | | | | | |
|--|---------------------|---------------------|----------------------|---------------------------------|-----------------------|---------------------------|
| EVENT NAME: | PRACTICE | ENVIRONMENT: | | LIVE | 1.0 | |
| WEAPON: | M249AR | CONDITIONS: | | LIVE FIRE | | |
| CATEGORY: | LIVE FIRE REHEARSAL | PRIMARY FACILITY: | | ARF | DAYS REQUIRED | |
| PUBLICATION: | TC 3-22.249 | ALTERNATE FACILITY: | | QTR | | |
| REQUIRED: | YES | COMPONENT: | AC | RC | 60 SOLDIERS | |
| RECORD: | DA Form 7801 | FREQUENCY: | 2 | 1 | | |
| VALID FOR: | T-X | ANNUAL DAYS TOTAL: | 2 | 1 | THROUGHPUT | |
| TABLE | | | | | | |
| I | | II | | III | | IV |
| PMI&E | | PLFS | | DRILLS | | BASIC |
| PRQ | | PRQ | | PRQ | | PRACTICE |
| PRQ | | PRQ | | PRQ | | 1.0 |
| WHEN EXECUTED: | | | | | T-X | |
| TNG DAYS TO QUAL | | | | | | |
| CONDEMNATION CRITERIA (CC) | RULE 1 | RULE 2 | RULE 3 | RULE 4 | RULE 5 | RULE 6 |
| | TIME | KEY LEADER TURNOVER | COMMANDER ASSESSMENT | SUBORDINATE ELEMENT PROFICIENCY | SPECIALTY PROFICIENCY | STAFF SECTION PROFICIENCY |
| <p>Remarks: Each Soldier assigned an individual weapon <i>should</i> successfully complete Table V, Practice, to gain experience with and confidence in their weapon, aiming devices, and skill.</p> | | | | | | |
| <p>Legend: AC – active component (known as active duty), AR – automatic rifle, ARF – automated record fire range or similar, DA – Department of the Army, EVAL – evaluation, PLFS – preliminary live-fire simulation, PMI&E – preliminary marksmanship instruction and evaluation, PRQ – prerequisite, QTR – qualification training range, QUAL – qualification, RC – Reserve Component (known as Reserves), TC – training circular, T-X – training event exercise, TNG DAYS TO QUAL – number of training days remaining on the critical path to weapon’s qualification</p> | | | | | | |

AMMUNITION

F-57. All Soldiers assigned an automatic rifle on a unit MAL should complete Automatic Rifle, Table V, Practice tasks, prior to advancing to Table VI, Qualification. Leaders conduct this event to demonstrate the Soldier’s proficiency to employ an automatic rifle during a close quarters fight prior to conducting the qualification course of fire, Table VI.

F-58. To effectively plan and forecast for sufficient training ammunition, the unit uses the ammunition requirements listed in table F-34. Units need to identify the total number of firers and should plan for unscheduled firers and necessary retraining by increasing their forecasted training as appropriate.

Table F-34. Automatic Rifle, Table V, Practice ammunition requirements

| <i>Training Event</i> | <i>DODIC</i> | <i>Nomenclature</i> | <i>Quantity</i> | <i>Remarks</i> |
|---|--------------|---|-----------------|--|
| Table IV, Stage 3 Confirmation at Distance | AB57 | CTG, 5.56mm, ball, M855A1 EPR | 5 | Conducted prior to Table V on the ARF or comparable facility when range restrictions or line- of-sight issues prevent completion of the task during Table IV. |
| Table IV, Stage 4 Application of Hold- Offs | AB57 | CTG, 5.56mm, ball, M855A1 EPR | 10 | Conducted prior to Table V on the ARF or comparable facility when range restrictions or line- of-sight issues prevent completion of the task during Table IV. |
| Note. Table IV, Stages 3 and 4 must be completed before Table V, Stage 1. | | | | |
| Table V, Stage 1 Practice | AB57 | CTG, 5.56mm, ball, M855A1 EPR | 50 | Three to five rounds per target during Phase 3, to each 25 round magazines. |
| | AB56 | CTG, 5.56mm, ball linked, M855A1 EPR | 150 | Three to five rounds per target required (killing burst). |
| Legend: ARF – automated record fire range, CTG – cartridge, DODIC – Department of Defense identification code, EPR – enhanced performance round, mm – millimeter | | | | |

F-59. The Table V event is an automated, timed event that consists of four live-fire phases. Leaders issue every firer ammunition as shown in table F-35 to conduct the event to standard. Firers place ammunition in their ammunition pouches. Staging or pre-positioning ammunition is not authorized for the conduct of Table V training.

Table F-35. Automatic Rifle, Table V, Practice ammunition breakdown

| <i>Sequence</i> | <i>Phase</i> | <i>AB57 5.56mm EPR, Ball Single Round</i> | <i>AB56 5.56mm EPR, Ball Linked</i> | <i>Remarks</i> |
|--|---------------------|---|---|---|
| 1 | Prone, Unsupported | | 50-round belt | |
| 2 | Prone, Supported | | 50-round belt | Transition to magazine fed ammunition. |
| 3 | Kneeling, Supported | 50 rounds (2 each 25-round magazines) | | Magazine to magazine fed. |
| 4 | Standing, Supported | | 50-round belt | Magazine to belt-fed ammunition. |
| Legend: EPR – enhanced performance round, mm – millimeter | | | | |

RANGE FACILITIES

F-60. Table F-36 shows the Army-standard range facilities specifically designed to support Automatic Rifle, Table V, Practice training. Units must refer to their installation’s range operations SOPs or local training regulation to identify the weapon specific range facilities. Units use their RFMSS system for all scheduling.

Table F-36. Automatic Rifle, Table V, Practice authorized range facilities

| <i>Table V</i> | <i>Targetry</i> | <i>Range Facility</i> | |
|---|--|-----------------------|------------|
| | | <i>ARF</i> | <i>QTR</i> |
| Practice | E-type, E1, target, silhouette: plastic, polyethylene, kneeling (NSN: 6920-00-071-4780) F-type, F-1 , target, silhouette: plastic, polyethylene, prone (NSN 6920-00-071-4589) | P | A |
| | D-type, D1, target, silhouette: plastic, mannequin, kneeling (NSN 6920-01-164-9625) D-type, D-2, target, 3-dimensional: plastic, mannequin, prone (NSN 6920-01-387-6397) | P | A |
| <p>Legend: A – alternate, ARF- automated record fire range, NSN – national stock number, P – primary, QTR – qualification training range</p> | | | |

TARGETRY

F-61. Table V requires silhouette targetry, either E-type, F-type, or D-type targets on the range. The leader must confirm the type and capability of the range's targetry, lifting mechanisms, simulators, and identify any unit requirements. During the preparation phase, leaders should be familiar with the targetry used and the sequence of the firing events. Figure F-21 shows the authorized targetry used during Table V training.





| | |
|--|--|
| <p align="center">E-1 Target, silhouette: plastic, polyethylene, kneeling NSN 6920-00-071-4780</p> | <p align="center">D-1 Target, 3-dimensional: plastic, mannequin, kneeling NSN 6920-01-164-9625</p> |
|  |  |
| <p align="center">F-1 Target, silhouette: plastic, polyethylene, prone NSN 6920-00-071-4589</p> | <p align="center">D-2 Target, 3-dimensional: plastic, mannequin, prone NSN 6920-01-387-6397</p> |
|  <p align="center">Prone targets are used only on the 50-meter RIGHT emplacement.</p> |  <p align="center">Prone targets are used only on the 50-meter RIGHT emplacement.</p> |
| <p>Notes:</p> <p>Use of E-1 or D-1 kneeling targets is at the discretion of the installation. Both represent dismounted, kneeling Infantry targets on small arms and maneuver facilities.</p> <p>Use F-1 or D-2 on the right 50-meter target emplacement only.</p> <p>Use of G-2 prone targets is not authorized.</p> | |
| <p>Legend: NSN – national stock number</p> | |

Figure F-21. Table V, authorized target types

SCENARIO ENGAGEMENTS

F-62. Targets are presented to the firer in single and multiple target arrays. Targets are presented so that 90 percent of the target is clearly visible to the firer from the expected or planned firing position. Targets are exposed to the firer based on the number of targets presented during the engagement as follows:

- Single target engagements are exposed for 3 seconds.
- Double target engagements are exposed for 5 seconds.
- Triple target engagements are exposed for 12 seconds.
- Quadruple target engagements are exposed for 16 seconds.

F-63. There is a two-second delay between each engagement. After each phase (prone unsupported, prone supported, kneeling supported, and standing supported), there is an eight-second transition delay, which provides the firer time to conduct an emergency reload and assume the next specified position. Table F-37 shows the scenario engagement sequence for Table V training.

Table F-37. Automatic Rifle Table V, Practice, engagement sequence

| <i>Table V, Practice, Engagements 1 through 5, React to Contact, Transition to Prone, Unsupported</i> | | | |
|---|--------------------|---------------|----------------------|
| <i>Engagement</i> | <i>Target Type</i> | <i>Range</i> | <i>Exposure Time</i> |
| 1 | F-type | 50 m RIGHT | 3 sec |
| 2 | E-type | 100 m | 3 sec |
| 3 | E-type | 150 m | 3 sec |
| 4 | E-type | 50 m LEFT | 12 sec |
| | E-type | 150 m | |
| | E-type | 200 m | |
| 5 | E-type | 150 m | 16 sec |
| | E-type | 200 m | |
| | E-type | 250 m | |
| | E-type | 300 m | |
| Prone, Unsupported, Time per Firing Order Total | | | 56 sec |
| <p>Note: There is a 5-second delay between the first and second engagement to allow the Soldier to go to prone. There is a 2-second delay between all other engagements in this table. An 8-second delay time is incorporated at the end of engagement 5 to facilitate ammunition and firing position changes.</p> | | | |
| <p>Legend: m – meters; sec – seconds</p> | | | |

Table F-37. Automatic Rifle, Table V, Practice engagement sequence (continued)

| <i>Table V, Practice, Engagements 6 through 10, Prone, Supported</i> | | | |
|---|--------------------|--------------|----------------------|
| <i>Engagement</i> | <i>Target Type</i> | <i>Range</i> | <i>Exposure Time</i> |
| 6 | E-type | 100 m | 3 sec |
| 7 | E-type | 150 m | 5 sec |
| | E-type | 300 m | |
| 8 | E-type | 200 m | 5 sec |
| | E-type | 300 m | |
| 9 | E-type | 250 m | 5 sec |
| | E-type | 300 m | |
| 10 | E-type | 150 m | 12 sec |
| | E-type | 250 m | |
| | E-type | 300 m | |
| Prone, Supported, Time per Firing Order Total | | | 46 sec |
| Note: There is a 2- second delay between all engagements. An 8-second delay time is incorporated at the end of engagement 10 to facilitate ammunition and firing position changes. | | | |
| Legend: m – meters; sec – seconds | | | |

Table F-37. Automatic Rifle, Table V, Practice engagement sequence (continued)

| <i>Table V, Practice, Engagements 11 through 14, Kneeling, Supported</i> | | | |
|--|--------------------|---------------|----------------------|
| <i>Engagement</i> | <i>Target Type</i> | <i>Range</i> | <i>Exposure Time</i> |
| 11 | E-type | 50 m LEFT | 12 sec |
| | E-type | 100 m | |
| | E-type | 200 m | |
| 12 | F-type | 50 m RIGHT | 5 sec |
| | E-type | 200 m | |
| 13 | E-type | 150 m | 5 sec |
| | E-type | 250 m | |
| 14 | E-type | 100 m | 12 sec |
| | E-type | 150 m | |
| | E-type | 200 m | |
| Kneeling, Supported, Time per Firing Order Total | | | 48 sec |
| Note: There is a 2-second delay between all engagements. An 8-second delay time is incorporated at the end of engagement 14 to facilitate ammunition and firing position changes. | | | |
| Legend: m – meters; sec – seconds | | | |

Table F-37. Automatic Rifle, Table V, Practice engagement sequence (continued)

| <i>Table V, Practice, Engagements 15 through 18, Standing, Supported</i> | | | |
|--|--------------------|---------------|----------------------|
| <i>Engagement</i> | <i>Target Type</i> | <i>Range</i> | <i>Exposure Time</i> |
| 15 | E-type | 50 m LEFT | 5 sec |
| | E-type | 100 m | |
| 16 | E-type | 200 m | 5 sec |
| | E-type | 250 m | |
| 17 | F-type | 50 m RIGHT | 12 sec |
| | E-type | 100 m | |
| | E-type | 150 m | |
| 18 | E-type | 100 m | 12 sec |
| | E-type | 200 m | |
| | E-type | 250 m | |
| Standing, Supported, Time per Firing Order Total | | | 40 sec |
| Note: There is a 2-second delay between all engagements. | | | |
| Legend: m – meters; sec – seconds | | | |

F-64. Table F-38, on page F-60, provides the Table V, Practice, throughput schedule, which is a guide that portrays the overall efficiency of the range facility when the unit is conducting the training event. It provides the overall throughput timetable, based on the time the unit requires to remove one firing order from the firing positions and move the next firing order forward.

F-65. Three general movement schedules are available to assist firing order placements on the range, 2 minutes, 5 minutes, and 10 minutes. The more proficient a unit is at operating a small arms range facility, the greater the firer throughput on the facility. This schedule does not include time required for retraining, refires, or firers who have persistent problems using a reticle.

Table F-38. Automatic Rifle, Table V, Practice throughput time schedule

| <i>Phase</i> | | <i>Time to Execute</i> | | <i>Remarks</i> | |
|--|---|------------------------|---------------|---|----------------|
| Prone, Unsupported | | 0:56 seconds | | Includes 2 seconds between engagements and 8 seconds transition to next phase. | |
| Prone, Supported | | 0:46 seconds | | | |
| Kneeling, Supported | | 0:48 seconds | | | |
| Standing, Supported | | 0:40 seconds | | Includes 2 seconds between engagements. | |
| Total Time Per Firing Order | | 3:10 minutes | | Does not include administrative time to move firing order to or from their respective firing positions. | |
| <i>Total Number of Firing Orders</i> | <i>Table V Execution with Administration Time Between Firing Orders</i> | | | <i>Total Firer Throughput based on Range Configuration</i> | |
| | <i>2 min</i> | <i>5 min</i> | <i>10 min</i> | <i>16 Lane</i> | <i>32 Lane</i> |
| 2 | 11 min | 17 min | 27 min | 32 | 64 |
| 3 | 16 min | 25 min | 40 min | 48 | 96 |
| 4 | 21 min | 33 min | 53 min | 64 | 128 |
| 5 | 26 min | 41 min | 1 hr 6 min | 80 | 160 |
| 6 | 32 min | 50 min | 1 hr 20 min | 96 | 192 |
| 7 | 37 min | 58 min | 1 hr 33 min | 112 | 224 |
| 8 | 42 min | 1 hr 6 min | 1 hr 46 min | 128 | 256 |
| 9 | 47 min | 1 hr 14 min | 1 hr 59 min | 144 | 288 |
| 10 | 53 min | 1 hr 23 min | 2 hrs 13 min | 160 | 320 |
| 11 | 58 min | 1 hr 31 min | 2 hrs 26 min | 176 | 352 |
| 12 | 1 hr 3 min | 1 hr 39 min | 2 hrs 39 min | 192 | 384 |
| 13 | 1 hr 8 min | 1 hr 47 min | 2 hrs 52 min | 208 | 416 |
| 14 | 1 hr 14 min | 1 hr 56 min | 3 hrs 6 min | 224 | 448 |
| 15 | 1 hr 19 min | 2 hrs 4 min | 3 hrs 19 min | 240 | 480 |
| 16 | 1 hr 24 min | 2 hrs 12 min | 3 hrs 32 min | 256 | 512 |
| 17 | 1 hr 29 min | 2 hrs 20 min | 3 hrs 45 min | 272 | 544 |
| 18 | 1 hr 35 min | 2 hrs 29 min | 3 hrs 59 min | 288 | 576 |
| 19 | 1 hr 40 min | 2 hrs 37 min | 4 hrs 12 min | 304 | 608 |
| 20 | 1 hr 45 min | 2 hrs 45 min | 4 hrs 25 min | 320 | 640 |
| Legend: hr – hour; hrs – hours, min – minutes | | | | | |

CONDUCT OF THE RANGE

F-66. Leaders instruct Soldiers on the objectives of Table V and the importance of the functional elements of the shot process. Table V contains 18 firing tasks with an administrative pause programmed at the end of each phase to facilitate emergency reloading and changing positions.

F-67. Soldiers enter the range and move to their firing points. Once at the firing point, firers assume a standing firing position with automatic rifles in a green status. Firers fire Table V tasks from the ready at varying firing positions throughout the duration of the course of fire, where—

- Tasks 1 through 5 are fired from the prone, unsupported firing position.
- Tasks 6 through 10 are fired from the prone, supported firing position.
- Tasks 11 through 14 are fired from the kneeling, supported firing position.
- Tasks 15 through 18 are fired from the standing, supported firing position.

F-68. Firers must hit a minimum of 28 of the 40 targets presented (70 percent) to successfully pass the event. Soldiers do not have to complete this table successfully before conducting Table VI training. This event is purposefully more rigorous than the qualification event where the targets are presented in a rapid tempo, and the time to transition between firing positions and tactical reloading are reduced. The leader annotates the official record of training on DA Form 7801.

F-69. Soldiers begin the Table V task by moving into the firing position with the use of administrative commands from the tower operator. The tower operator uses administrative commands to control the flow of the range, movement of personnel, and other command and control purposes. Table F-39 provides an example of the administrative commands for moving a new firing order into position.

Table F-39. Table V, new firing order, conduct of the range example

| <i>New Firing Order, Conduct of the Range</i> | | | |
|--|---|--|-----------------------|
| | Task | Target | Target Type |
| PRACTICE | New Firing Order | N/A | N/A |
| | Rounds per Target | DODIC | Time (Seconds) |
| | N/A | AB57 / AB56 | NO LIMIT |
| TOWER | | SOLDIER ACTION | |
| CONDUCT OF THE RANGE | SECURE YOUR AMMUNITION AND MOVE TO YOUR FIRING POINT | Soldiers secure their weapon in a GREEN status, their training ammunition and move to the designated firing point. | |
| Once all firers are complete, conduct of the range continues. | | | |
| Legend: DODIC – Department of Defense identification code, N/A – not applicable | | | |

F-70. If the unit cannot complete the zero confirmation or application of hold-off tasks during Table IV training, the unit must provide 15-rounds to each firer. The firing order will conduct stages 3 and 4 from Table IV prior to beginning Table V training.

F-71. Units can use the following guide (table F-40, on page F-62) to complete the confirmation at distance task. Firers must have five-rounds to conduct the event. Firers are in a green status at their assigned firing point.

Table F-40. Table IV, engagement 7, confirmation at distance, conduct of fire example

| <i>Table IV, Engagement 7 – Zero Confirmation at Distance</i> | | | |
|---|--|--|-------------------------------------|
|  <p>300 meter (Unit may select different zero range based on their SOP, TTP, or mission requirements).</p> | Zero Confirmation | Target | Target Type |
| | 1 | E-1 or D-1 | Silhouette, kneeling (hit-bob mode) |
| | Rounds per Engagement | DODIC | Time (Seconds) |
| | 5 | AB57 | NO LIMIT |
| TOWER | | SOLDIER ACTION | |
| WEAPONS SAFETY STATUS RED | GO TO PRONE MAKE READY | Soldier moves to the PRONE supported position, establishes a good firing position, and loads one single round magazine. | |
| ALERT | FIRERS | | |
| TARGET DESCRIPTION | TROOP | Soldier acquires the zero confirmation target. | |
| DIRECTION | FRONT | | |
| RANGE | THREE-HUNDRED | Soldier acquires the target and identifies the target's center of visible mass (known as CoVM). | |
| CONTROL | FIVE ROUNDS SLOW FIRE WEAPONS FREE WEAPONS FREE | | |
| EXECUTION | ENGAGE UPON POSITIVE IDENTIFICATION | Soldier begins slow firing a five-round shot group, ensuring the same point of aim for each round. | |
| ONCE ALL FIRERS ARE COMPLETE WITH THE FIVE-ROUND CONFIRMATION AT DISTANCE: | | | |
| TERMINATION | CEASE FIRE CEASE FIRE | The firer's BOLT should be locked to the rear. Tower must assume all weapons are RED. | |
| WEAPONS SAFETY STATUS GREEN | GO GREEN SHOW CLEAR | Soldiers clear their weapons, show clear to the lane safety. | |
| Firer's should achieve four of five hits to successfully complete confirmation at distance. The tower should identify any firer that has not met the confirmation standard and move those Soldiers to the retraining location. | | | |
| Legend: DODIC – Department of Defense identification code, SOP – standard operating procedure, TTP – tactics, techniques, and procedures | | | |

F-72. Once all firers have completed stage 3, they remain in place and await further instructions from the tower operator. The tower operator instructs them to reload and prepare for stage 4. Table F-41 shows an example of the conduct of fire for Table IV, stage 4 tasks.

Table F-41. Table IV, engagement 8, application of hold-offs, conduct of fire example

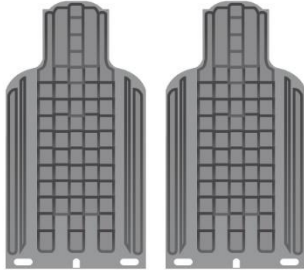
| <i>Table IV, Engagement 8 – Application of Hold-Offs</i> | | | |
|---|--|--|-------------------------------------|
|  <p>100 and 200 meter</p> | Application of Hold-Offs | Target | Target Type |
| | 1 | E-1 or D-1 | Silhouette, kneeling (hit-bob mode) |
| | Rounds per Engagement | DODIC | Time (Seconds) |
| | 10 | AB57 | 55 |
| TOWER | | SOLDIER ACTION | |
| WEAPONS SAFETY STATUS RED | MAKE READY | Soldier remains in the PRONE supported position, establishes a good firing position, and loads one single round magazine. | |
| ALERT | CONTACT | | |
| TARGET DESCRIPTION | TROOPS | Soldier acquires the 100 meter target. | |
| DIRECTION | FRONT | | |
| RANGE | ONE-HUNDRED AND TWO HUNDRED | Soldier acquires the target and identifies the target's center of visible mass (known as CoVM). | |
| CONTROL | FIVE ROUNDS SLOW FIRE WEAPONS FREE WEAPONS FREE | | |
| EXECUTION | ENGAGE UPON POSITIVE IDENTIFICATION | Soldier begins slow firing a five-round shot group, applying the appropriate hold-off at the 100 meter target and again at the 200 meter target. | |
| ONCE ALL FIRERS ARE COMPLETE WITH THE 10-ROUND APPLICATION OF HOLD-OFF | | | |
| TERMINATION | CEASE FIRE CEASE FIRE | The firer's BOLT should be locked to the rear. Tower must assume all weapons are RED. | |
| WEAPONS SAFETY STATUS GREEN | GO GREEN SHOW CLEAR | Soldiers clear their weapons, show clear to the lane safety. | |
| Firer's should achieve four of five hits on each target to successfully complete application of hold-offs. The tower should identify any firer that has not met the standard and move those Soldiers to the retraining location. | | | |
| Legend: DODIC – Department of Defense identification code, SOP – standard operating procedure, TTP – tactics, techniques, and procedures, | | | |

F-73. The following engagement sequence guide initiates the Table V scenario. Tables F-42 through F-45, on pages F-64 through F-67 are the engagement sequences with a generic conduct of fire process for the tower operator.

Table F-42. Table V, engagement 1 through 5, conduct of fire example

| <i>Engagement 1 through 5 – Day, Prone, Unsupported</i> | | | |
|--|--|---|-----------------------|
| | Engagement | Target | Target Type |
| | 1 through 5 | E-1 F-1 | Point |
| | Rounds | DODIC | Time (Seconds) |
| | 50-round belt | AB56 | 56 |
| TOWER | | SOLDIER ACTION | |
| WEAPONS SAFETY STATUS RED | | MAKE READY | |
| WEAPONS SAFETY STATUS RED | | Soldier assumes a STANDING UNSUPPORTED firing position and loads one 50-round belt. | |
| ALERT | CONTACT | | |
| TARGET DESCRIPTION | TROOPS | | |
| DIRECTION | FRONT | | |
| RANGE | MID-RANGE | | |
| METHOD | NEAR TO FAR | | |
| CONTROL | WEAPONS FREE WEAPONS FREE | Soldier moves the weapon from SAFE to FIRE, and begins the target acquisition process. | |
| EXECUTION | ENGAGE UPON POSITIVE IDENTIFICATION | Soldier engages the first target from the STANDING UNSUPPORTED firing position then goes to the PRONE UNSUPPORTED firing position. Soldier acquires, prioritizes, and engages targets with one killing burst per target. | |
| TOWER AWAITS COMPLETION OF ENGAGEMENT 5 THEN PROCEEDS IMMEDIATELY | | | |
| WEAPONS SAFETY STATUS REMAINS RED | | | |
| Note: There is a 5-second delay between the first and second engagement to allow the Soldier to go to prone. There is a 2-second delay between all other engagements in this table. There is an 8-second delay at the end of the phase to support changing ammunition and changing the firing position. | | | |
| Legend: DODIC – Department of Defense identification code | | | |

Table F-43. Table V, engagement 6 through 10, conduct of fire example

| <i>Engagement 6 through 10 – Day, Prone, Supported</i> | | | |
|---|---|---|--|
| | Engagement | Target | Target Type |
| | 6 through 10 | E-1 | Point |
| | Rounds | DODIC | Time (Seconds) |
| | 50-round belt | AB56 | 46 |
| TOWER | | SOLDIER ACTION | |
| WEAPONS SAFETY STATUS RED | <i>Although the firer's bolt should be locked to the rear, the tower must treat all weapons as if in a RED status</i> | | Soldier remains in the PRONE position, at the READY and may RELOAD or await instructions. |
| CONTROL | GO TO PRONE SUPPORTED RELOAD | The Soldier conducts a RELOAD and establishes a PRONE, SUPPORTED position and prepares to engage. | |
| TOWER AWAITS THE END OF THE 8-SECOND TRANSITION THEN PROCEEDS | | | |
| WEAPONS SAFETY STATUS REMAINS RED | | | |
| EXECUTION | ENGAGE UPON POSITIVE IDENTIFICATION | | Soldier acquires, prioritizes, and engages targets with one killing burst per target. |
| TOWER AWAITS COMPLETION OF ENGAGEMENT 10 THEN PROCEEDS IMMEDIATELY | | | |
| WEAPONS SAFETY STATUS REMAINS RED | | | |
| Note: There is a 2-second delay between all engagements. There is an 8-second delay at the end of the phase to support emergency magazine change and changing the firing position. | | | |
| Legend: DODIC – Department of Defense identification code | | | |

Table F-44. Table V, engagement 11 through 14, conduct of fire example

| <i>Engagement 11 through 14 – Kneeling, Supported</i> | | | |
|--|--|---|-----------------------|
| | Engagement | Target | Target Type |
| | 11 through 14 | E-1 F-1 | Point |
| | Rounds | DODIC | Time (Seconds) |
| | 2 magazines, 25 rounds each | AB57 (50) | 48 |
| TOWER | | SOLDIER ACTION | |
| WEAPONS SAFETY STATUS RED | <i>Although the firer's bolt should be locked to the rear, the tower must treat all weapons as if in a RED status.</i> | Soldier remains at the READY and may RELOAD one 25-round magazine or await instructions. | |
| CONTROL | RELOAD MAGAZINE FIGHT UP | The Soldier conducts an emergency RELOAD of one 25-round magazine, and assumes the KNEELING, SUPPORTED position. | |
| TOWER AWAITS THE END OF THE 8-SECOND TRANSITION THEN PROCEEDS | | | |
| WEAPONS SAFETY STATUS REMAINS RED | | | |
| EXECUTION | ENGAGE UPON POSITIVE IDENTIFICATION | Soldier acquires, prioritizes, and engages targets with one killing burst per target. Firers may conduct an EMERGENCY RELOAD with one additional 25-round magazine based on the tactical situation. | |
| TOWER AWAITS COMPLETION OF ENGAGEMENT 14 THEN PROCEEDS | | | |
| WEAPONS SAFETY STATUS REMAINS RED | | | |
| <p>Note: There is a 2-second delay between all engagements. There is an 8-second delay at the end of the phase to support changing ammunition and changing the firing position.</p> | | | |
| <p>Legend: DODIC – Department of Defense identification code</p> | | | |

Table F-45. Table V, engagement 15 through 18, conduct of fire example

| <i>Engagement 15 through 18 – Standing, Supported</i> | | | |
|---|--|--|---|
| | Engagement | Target | Target Type |
| | 15 through 18 | E-1 F-1 | Point |
| | Rounds | DODIC | Time (Seconds) |
| | 50-round belt | AB56 | 48 |
| TOWER | | SOLDIER ACTION | |
| WEAPONS SAFETY STATUS RED | <i>Although the firer's bolt should be locked to the rear, the tower must treat all weapons as if in a RED status.</i> | | Soldier remains at the READY and may RELOAD or await instructions. |
| CONTROL | RELOAD FIGHT UP | The Soldier conducts a RELOAD and assumes the STANDING, SUPPORTED position. | |
| TOWER AWAITS THE END OF THE 8-SECOND TRANSITION THEN PROCEEDS | | | |
| WEAPONS SAFETY STATUS REMAINS RED | | | |
| EXECUTION | ENGAGE UPON POSITIVE IDENTIFICATION | Soldier acquires, prioritizes, and engages targets with one killing burst per target. | |
| TOWER AWAITS COMPLETION OF ENGAGEMENT 18 THEN PROCEEDS | | | |
| WEAPONS SAFETY STATUS REMAINS RED | | | |
| Note: There is a 2-second delay between all engagements. This completes the day firing phase for Table V. There are no alibis authorized. Any remaining ammunition is returned to the ammunition issue point for redistribution. | | | |
| Legend: DODIC – Department of Defense identification code | | | |

F-74. A lane safety clears the firers upon their completion of Table V tasks and collecting their dunnage. A lane safety verifies the clearing prior to the Soldiers moving from their firing point. Once the lane safety clears all the Soldiers, the lane safety communicates the WSS to the tower operator and the tower operator issues an administrative command to move the completed Soldiers off the range. Table F-46 is an example of this command, also.

Table F-46. Table V, completed firing order, conduct of the range example

| <i>Firing Order Complete</i> | | | |
|--|--|--|----------------|
| FIRING ORDER COMPLETE | Task | Target | Target Type |
| | Completed Firing Order | N/A | N/A |
| | Rounds per Target | DODIC | Time (Seconds) |
| | N/A | N/A | NO LIMIT |
| TOWER | | SOLDIER ACTION | |
| TOWER MUST ASSUME ALL FIRERS' WEAPON SAFETY STATUS IS RED | | | |
| TERMINATION | CEASE FIRE CEASE FIRE | Soldiers stop firing and place weapons on SAFE. | |
| WEAPONS SAFETY STATUS GREEN | GO GREEN GO GREEN ONCE VERIFIED BY THE RSO, SECURE WEAPON | Soldiers clear their weapon and wait to be inspected by a lane safety. | |
| CONDUCT OF THE RANGE | FIRERS SECURE YOUR DUNNAGE MOVE TO THE BASELINE. | Firers secure weapon and ammunition dunnage and move to the designated location. | |
| Once all firers return to the baseline, tower directs the firing order off the range. | | | |
| Legend: DODIC – Department of Defense identification code, N/A – not applicable, RSO – range safety officer | | | |

F-75. As soon as the lane safety clears the completed firing order, the tower operator moves a new firing order into position and the process repeats itself until all firers have completed Table V, Practice, event successfully. Any identified firers that require retraining move to the appropriate concurrent training location.

AUTOMATIC RIFLE, TABLE VI, QUALIFICATION

F-76. Leaders use Table VI, Qualification to demonstrate the firer’s proficiency at common engagement and tactical skills. Table VI tasks challenge firers using single and multiple stationary targets between 50- and 300-meters, from the prone unsupported, prone supported, kneeling supported, and standing supported firing positions. Table VI tasks evaluate the firer’s ability to engage single and multiple targets placed in a tactical array using their primary optic and applying the functional elements of the shot process. In a timed scenario, the firer demonstrates target prioritization and weapons manipulation. Table VI training occurs on an ARF or comparable range facility.

TASK, CONDITIONS, AND STANDARD

F-77. Table F-47 outlines the task, conditions, and standard for Table VI training. The firer conducting the event should know the task, conditions, and standard and should explain them during the conduct of the range briefing.

Table F-47. Automatic Rifle, Table VI, Qualification task, conditions, and standard

| | |
|---|--|
| Task: | Engage and defeat single and multiple threats at varying ranges from supported or unsupported standing, kneeling, and prone firing positions, during day and limited visibility conditions using ball ammunition. |
| Conditions: | <p>Given the following:</p> <ul style="list-style-type: none"> • Fully mission capable weapon as assigned on the master authorization list for the unit. • Full combat uniform, issued equipment, and protective mask. • Authorized range facility. • Authorized simulator system (Day Fire, CBRN; Night Fire; and Night Fire, CBRN). • Full-scale, approved targetry in standard scenario engagement sequences. • Authorized ammunition. |
| Standard: | <p>Demonstrate engagement proficiency by stage, such that:</p> <ul style="list-style-type: none"> • Stage 1 – Day Fire – hitting 57.5 percent (23 of 40) of all presented targets in the time allotted. • Stage 2 – Day Fire, CBRN – receive a GO by successfully hitting 70-percent (7 of 10) of targets presented while operating in a notional chemical environment. • Stage 3 – Night Fire – receive a GO by successfully hitting 70-percent (14 of 20) of targets presented during limited visibility conditions. • Stage 4 – Night Fire, CBRN – receive a GO by successfully hitting 70-percent (7 of 10) of targets presented while operating in a notional chemical environment. |
| <p>Note. Units supported by an authorized simulation system conduct Day Fire, CBRN (Stage 2), Night Fire (Stage 3), and Night Fire, CBRN (Stage 4) portions of Table VI in their simulated system.</p> <p>Units that do not have an assigned authorized simulator system, complete stages 2 through 4, live, under live-fire conditions, at the end of Stage 1, Day, Unlimited Visibility.</p> | |
| <p>Legend: CBRN – chemical, biological, radiological, and nuclear</p> | |

F-78. Table F-48 shows the training event design template for Automatic Rifle, Table VI, Qualification. Units conduct this event on an authorized live-fire facility, typically an ARF or comparable range facility. See TC 25-8 for additional information on authorized range facilities.

Table F-48. Training event design template for Automatic Rifle, Table VI, Qualification

| <i>Automatic Rifle, Table VI, Qualification Live-Fire Proficiency Gate</i> | | | | | | | |
|---|-----------------------|---------------------|----------------------|---------------------------------|-----------------------|---------------------------|----------|
| EVENT NAME: | QUALIFICATION | ENVIRONMENT: | | LIVE | 1.0 | | |
| WEAPON: | M4 / M16 | CONDITIONS: | | LIVE FIRE | | | |
| CATEGORY: | LIVE-FIRE PROFICIENCY | PRIMARY FACILITY: | | ARF | DAYS REQUIRED | | |
| PUBLICATION: | TC 3-22.249 | ALTERNATE FACILITY: | | QTR | | | |
| REQUIRED: | YES | COMPONENT: | AC | RC | 120 SOLDIERS | | |
| RECORD: | DA Form 7801 | FREQUENCY: | 2 | 1 | | | |
| VALID FOR: | 12 MONTHS | ANNUAL DAYS TOTAL: | 2 | 1 | THROUGHPUT | | |
| TABLE | | | | | | | |
| | | I | II | III | IV | V | VI |
| | | PMI&E | PLFS | DRILLS | BASIC | PRACTICE | QUAL |
| | | PRQ | PRQ | PRQ | | | REQUIRED |
| WHEN EXECUTED: | | | | | | | T-X |
| CONDEMNATION CRITERIA (CC) | RULE 1 | RULE 2 | RULE 3 | RULE 4 | RULE 5 | RULE 6 | |
| | TIME | KEY LEADER TURNOVER | COMMANDER ASSESSMENT | SUBORDINATE ELEMENT PROFICIENCY | SPECIALTY PROFICIENCY | STAFF SECTION PROFICIENCY | |
| <p>Remarks: Each Soldier assigned an individual weapon <i>must</i> successfully complete Table VI, Qualification tasks to meet their live-fire proficiency gate. The live-fire proficiency gate is required for any Soldier to participate in <i>any collective live-fire event</i>.</p> | | | | | | | |
| <p>Note: Table III should be used as concurrent training on Tables IV, V, and VI while Soldiers are awaiting training in a firing order or between day and night phases.</p> | | | | | | | |
| <p>Legend: AC – active component (known as active duty), ARF – automated record fire range, DA – Department of the Army, PLFS – preliminary live-fire simulation, PMI&E – preliminary marksmanship instruction and evaluation, PRQ – prerequisite, QTR – qualification training range, QUAL – qualification, RC – Reserve Component (known as Reserves), TC – training circular, TNG DAYS TO QUAL – number of training days remaining on the critical path to weapon’s qualification, T-X – training event exercise,</p> | | | | | | | |

F-79. Due to the varying training environments required to qualify the capabilities of the weapon and to enable the Soldier to effectively demonstrate proficiency, this course of fire is conducted in stages. Units that have access to an approved simulations system complete stage 2, stage 3, and stage 4 in that system. Only units that do not have access to an approved simulator system receive the training ammunition to conduct all stages as live-fire scenarios during qualification. Table F-49 describes the stages which are conditions based.

Table F-49. Stage descriptions, Automatic Rifle, Table VI, Qualification

| Stage | Conditions | Virtual | Live | Remarks |
|--|-------------------|----------------|-------------|--|
| Stage 1 | Day Fire | NA | P | All Soldiers complete Stage 1 live under live-fire conditions. |
| Stage 2 | Day Fire, CBRN | P | A | Completed after Stage 1 |
| Stage 3 | Night Fire | P | A | Completed after Stage 2. |
| Stage 4 | Night Fire, CBRN | P | A | Completed after Stage 3 |
| Note. No firer may use virtual systems to complete Stage 1, Automatic Rifle, Table VI, Qualification tasks. | | | | |
| Legend: A – authorized only when no approved simulator system is available to the unit, CBRN – chemical, biological, radiological, and nuclear, P – primary method of execution, NA – Not Authorized. | | | | |

AMMUNITION

F-80. All Soldiers assigned an automatic rifle on a unit MAL must complete Automatic Rifle, Table VI, Qualification tasks. Soldiers conduct this event to demonstrate their proficiency in lethally employing an automatic rifle against mid-range threats.

F-81. To effectively plan and forecast for sufficient training ammunition, the unit uses the ammunition requirements listed in table F-50. Units need to identify the total number of firers and should plan for unscheduled firers and necessary retraining by increasing their forecasted training, as appropriate.

Table F-50. Automatic Rifle, Table VI, Qualification ammunition requirements

| <i>Stage</i> | <i>Event</i> | <i>DODIC</i> | <i>Nomenclature</i> | <i>QTY</i> | <i>Remarks</i> |
|---|--------------------------|--------------|---|------------|--|
| Table IV, Stage 3 | Confirmation at Distance | AB57 | CTG, 5.56mm, ball, single round, M855A1 EPR | 5 | Conducted prior to Table VI on the ARF or comparable facility when range restrictions or line-of-sight issues prevent completion of the task during Table IV. |
| Table IV, Stage 4 | Application of Hold-Offs | AB57 | CTG, 5.56mm, ball, single round, M855A1 EPR | 10 | Conducted prior to Table VI on the ARF or comparable facility when range restrictions or line-of-sight issues prevent completion of the task during Table IV. |
| Note. Table IV, Stages 3 and 4 must be completed before Table VI, Stage 1. | | | | | |
| Stage 1 | Day Fire | AB56 | CTG, 5.56mm, ball, linked, M855A1 EPR | 200 | 3 to 5 rounds per target required (killing burst). Single cartridges used to demonstrate reloading to magazine and belted-ammunition proficiency. |
| Stage 2 | Day Fire, CBRN | AB56 | CTG, 5.56mm, ball, linked, M855A1 EPR | 50 | When authorized simulator system is available, no rounds are authorized. 3 to 5 rounds per target required (killing burst). 4:1 Linked for Night Fire events only. |
| Stage 3 | Night Fire | AB73 | CTG, 5.56mm, ball, M855A1, tracer, M856A1, 4:1 linked EPR | 100 | |
| Stage 4 | Night Fire, CBRN | AB73 | CTG, 5.56mm, ball, M855A1, tracer, M856A1, 4:1 linked EPR | 50 | |
| Legend: ARF – automated record fire range, CBRN – chemical, biological, radiological, and nuclear; CTG – cartridge, DODIC – Department of Defense identification code, EPR – enhanced performance round, mm – millimeter; QTY – quantity | | | | | |

F-82. Table VI task is an automated timed event of four live-fire phases. Leaders issue ammunition to every firer as shown in table F-51 to conduct the event to standard based on their accessibility to approved simulations systems. Firers place ammunition in their ammunition pouches. Staging or pre-positioning ammunition is not authorized for the conduct of Table VI training.

Table F-51. Automatic Rifle, Table VI, Qualification ammunition breakdown

| <i>Stage</i> | <i>Event</i> | <i>Phase</i> | <i>Sequence</i> | <i>AB56 5.56mm Ball Linked</i> | <i>AB73 5.56mm 4:1 Linked</i> |
|---|---------------------------------|--------------------------|-----------------|--|---|
| Stage 1 | Day Fire | Prone, Unsupported | 1 | 50-round belt | |
| | | Prone, Supported | 2 | 50-round belt | |
| | | Kneeling, Supported | 3 | 50-round belt | |
| | | Standing, Supported | 4 | 50-round belt | |
| Stage 2 | Day Fire, CBRN | Standing, Unsupported | 5 | 50-round belt | |
| Stage 3 | Night Fire | Kneeling, Supported | 1 | | 50-round belt |
| | | Standing, Supported | 2 | | 50-round belt |
| Stage 4 | Night Fire, CBRN | Standing, Unsupported | 3 | | 50-round belt |
| Note: Stage 2, 3, and 4 are conducted live under live-fire conditions only when authorized (an approved simulator system is unavailable.) | | | | | |
| Legend: 4:1 – 4 each ball, 1 each tracer, linked ammunition; CBRN – chemical, biological, radiological, and nuclear; mags – magazines, mm – millimeter | | | | | |

RANGE FACILITIES

F-83. Table F-52 shows the Army-standard range facilities specifically designed to support Automatic Rifle, Table VI, Qualification training. Units must refer to their installation’s range operations SOPs or local training regulation to identify the weapon specific range facilities. Units use their RFMSS system for all scheduling.

Table F-52. Automatic Rifle, Table VI, Qualification authorized range facilities

| Table VI | Targetry | Range Facility | |
|---|---|----------------|-----|
| | | ARF | QTR |
| Qualification | E-type, E1, target, silhouette: plastic, polyethylene, kneeling (NSN: 6920-00-071-4780) | P | A |
| | F-type, F-1 , target, silhouette: plastic, polyethylene, prone (NSN 6920-00-071-4589) | | |
| | D-type, D1, target, silhouette: plastic, mannequin, kneeling (NSN 6920-01-164-9625) | P | A |
| | D-type, D-2, target, 3-dimensional: plastic, mannequin, prone (NSN 6920-01-387-6397) | | |
| <p>Legend: A – alternate, ARF- automated record fire range, NSN – national stock number, P – primary, QTR – qualification training tange</p> | | | |

TARGETRY

F-84. Table VI tasks require silhouette targetry, either E-type, F-type, or D-type targets on the range. The leader must confirm the type and capability of the range's targetry, lifting mechanisms, simulators and identify any unit requirements. During the preparation phase, leaders should be familiar with the targetry used and the sequence of the firing events. Figure F-22 shows the authorized targetry used with Table VI elements.





| | |
|--|---|
| <p>E-1 Target, silhouette: plastic, polyethylene, kneeling NSN 6920-00-071-4780</p> | <p>D-1 Target, 3-dimensional: plastic, mannequin, kneeling NSN 6920-01-164-9625</p> |
|  |  |
| <p>F-1 Target, silhouette: plastic, polyethylene, prone NSN 6920-00-071-4589</p> | <p>D-2 Target, 3-dimensional: plastic, mannequin, prone NSN 6920-01-387-6397</p> |
|  <p>Prone targets are used only on the 50-meter RIGHT emplacement.</p> |  <p>Prone targets are used only on the 50-meter RIGHT emplacement.</p> |
| <p>Notes:</p> <p>Use of E-1 or D-1 kneeling targets is at the discretion of the installation. Both represent dismounted, kneeling Infantry targets on small arms and maneuver facilities.</p> <p>Use F-1 or D-2 on the right 50-meter target emplacement only.</p> <p>Use of G-2 prone targets is not authorized.</p> | |
| <p>Legend: m – meter, NSN – national stock number</p> | |

Figure F-22. Table VI, authorized target types

STAGE 1 – DAY FIRE

F-85. Stage 1, Day Fire is a required event as part of automatic rifle qualification. Leaders use stage 1 to train and evaluate the firer's ability to engage targets while operating with individual chemical protective equipment. At a minimum, Soldiers are required to fire this course of fire while wearing individual combat equipment. All Soldiers assigned an automatic rifle must complete this course of fire as part of their qualification.

AMMUNITION

F-86. To effectively plan and forecast for sufficient training ammunition, the unit uses the ammunition requirements listed in table F-53. Units need to identify the total number of firers and should plan for unscheduled firers and necessary retraining by increasing their forecasted training ammunition as appropriate.

Table F-53. Automatic Rifle, Table VI, Qualification, Stage 1, Day Fire, ammunition breakdown

| <i>Stage 1</i> | <i>Phase</i> | <i>Sequence Magazine</i> | <i>AB56 5.56mm Ball Linked</i> |
|---|---------------------|--------------------------|--|
| Day Fire | Prone, Unsupported | 1 | 50-round belt |
| | Prone, Supported | 2 | 50-round belt |
| | Kneeling, Supported | 3 | 50-round belt |
| | Standing, Supported | 4 | 50-round belt |
| Total: | | | 200 rounds |
| Legend: 4:1 – 4 each ball, 1 each tracer, linked ammunition; mags – magazines, mm – millimeter | | | |

SCENARIO ENGAGEMENTS

F-87. Targets are presented to the firer in single and multiple target arrays. Targets are presented so that 90 percent of the target is clearly visible to the firer from the expected or planned firing position. Targets are exposed to the firer based on the number of targets presented during the engagement as follows:

- Single target engagements are exposed for 5 seconds.
- Double target engagements are exposed for 8 seconds.
- Triple target engagements are exposed for 12 seconds.
- Quadruple target engagements are exposed for 16 seconds.

F-88. There is a 3-second delay between each engagement. After each phase (prone unsupported, prone supported, kneeling supported, and standing supported), there is a 10-second transition delay providing the firer time to conduct a reload and assume the next specified position. Table F-54 shows the scenario engagement sequence for Table VI training.

Table F-54. Automatic Rifle Table VI, Qualification, Stage 1, Day Fire, engagement sequence

| <i>Table VI, Qualification, Engagements 1 through 5, React to Contact, Transition to Prone, Unsupported</i> | | | |
|--|--------------------|---------------|----------------------|
| <i>Engagement</i> | <i>Target Type</i> | <i>Range</i> | <i>Exposure Time</i> |
| 1 | F-type | 50 m RIGHT | 5 sec |
| 2 | E-type | 100 m | 5 sec |
| 3 | E-type | 150 m | 5 sec |
| 4 | E-type | 50 m LEFT | 12 sec |
| | E-type | 150 m | |
| | E-type | 200 m | |
| 5 | E-type | 150 m | 16 sec |
| | E-type | 200 m | |
| | E-type | 250 m | |
| | E-type | 300 m | |
| Prone, Unsupported, Time per Firing Order Total | | | 67 sec |
| Note: There is a 5-second delay between the first and second engagement to allow the Soldier to go to prone. There is a 3-second delay between all other engagements in this table. A 10-second delay time is incorporated at the end of engagement 5 to facilitate ammunition and firing position changes. | | | |
| Legend: m – meters; sec – seconds | | | |

Table F-54. Automatic Rifle, Table VI, Qualification, Stage 1, Day Fire, engagement sequence (continued)

| <i>Table VI, Qualification, Engagements 6 through 10, Prone, Supported</i> | | | |
|--|--------------------|--------------|----------------------|
| <i>Engagement</i> | <i>Target Type</i> | <i>Range</i> | <i>Exposure Time</i> |
| 6 | E-type | 100 m | 5 sec |
| 7 | E-type | 150 m | 8 sec |
| | E-type | 300 m | |
| 8 | E-type | 200 m | 8 sec |
| | E-type | 300 m | |
| 9 | E-type | 250 m | 8 sec |
| | E-type | 300 m | |
| 10 | E-type | 150 m | 12 sec |
| | E-type | 250 m | |
| | E-type | 300 m | |
| Prone, Supported, Time per Firing Order Total | | | 63 sec |
| Note: There is a 3-second delay between all engagements. A 10-second delay time is incorporated at the end of engagement 10 to facilitate ammunition and firing position changes. | | | |
| Legend: m – meters; sec – seconds | | | |

Table F-54. Automatic Rifle, Table VI, Qualification, engagement sequence (continued)

| <i>Table VI, Qualification, Engagements 11 through 14, Kneeling, Supported</i> | | | |
|--|--------------------|---------------|----------------------|
| <i>Engagement</i> | <i>Target Type</i> | <i>Range</i> | <i>Exposure Time</i> |
| 11 | E-type | 50 m LEFT | 12 sec |
| | E-type | 100 m | |
| | E-type | 200 m | |
| 12 | F-type | 50 m RIGHT | 8 sec |
| | E-type | 200 m | |
| 13 | E-type | 150 m | 8 sec |
| | E-type | 250 m | |
| 14 | E-type | 100 m | 12 sec |
| | E-type | 150 m | |
| | E-type | 200 m | |
| Kneeling, Supported, Time per Firing Order Total | | | 59 sec |
| Note: There is a 3-second delay between all engagements. A 10-second delay time is incorporated at the end of engagement 14 to facilitate ammunition and firing position changes. | | | |
| Legend: m – meters; sec – seconds | | | |

Table F-54. Automatic Rifle, Table VI, Qualification, engagement sequence (continued)

| <i>Table VI, Qualification, Engagements 15 through 18, Standing, Supported</i> | | | |
|--|--------------------|---------------|----------------------|
| <i>Engagement</i> | <i>Target Type</i> | <i>Range</i> | <i>Exposure Time</i> |
| 15 | E-type | 50 m LEFT | 8 sec |
| | E-type | 100 m | |
| 16 | E-type | 200 m | 8 sec |
| | E-type | 250 m | |
| 17 | F-type | 50 m RIGHT | 12 sec |
| | E-type | 100 m | |
| | E-type | 150 m | |
| 18 | E-type | 100 m | 12 sec |
| | E-type | 200 m | |
| | E-type | 250 m | |
| Standing, Supported, Time per Firing Order Total | | | 49 sec |
| Note: There is a 3-second delay between all engagements. | | | |
| Legend: m – meters; sec – seconds | | | |

F-89. Throughput schedules are guides that portray the overall efficiency of the range facility when the unit is conducting the training event. Throughput schedules provide the overall throughput timetable, based on the time the unit requires to remove one firing order from the firing positions and move the next firing order forward. Table F-55 provides the Table VI, Qualification, Stage 1, Day Fire throughput schedule. Table F-56, page F-82, provides the throughput schedule for completing stage 1 and stage 2 events sequentially.

F-90. Three general movement schedules are available to assist firing order placements on the range, 2 minutes, 5 minutes, and 10 minutes. The more proficient a unit is at operating a small arms range facility, the greater the firer throughput on the facility. This schedule does not include time required for retraining, refires, or firers who have persistent problems using a reticle.

Table F-55. Stage 1, Day Fire throughput time schedule

| <i>Phase</i> | <i>Time to Execute</i> | <i>Remarks</i> | | | |
|--|--|---|---------------|--|----------------|
| Prone, Unsupported | 1:07 minute | Includes 3 seconds between engagements and 10 seconds transition to next phase. | | | |
| Prone, Supported | 1:03 minute | | | | |
| Kneeling, Supported | 0:59 seconds | | | | |
| Standing, Supported | 0:49 seconds | Includes 3 seconds between engagements. | | | |
| Total Time Per Firing Order | 3:58 minutes | Does not include administrative time to move firing order to or from their respective firing positions. | | | |
| <i>Total Number of Firing Orders</i> | <i>Table VI Execution with Administration Time Between Firing Orders</i> | | | <i>Total Firer Throughput based on Range Configuration</i> | |
| | <i>2 min</i> | <i>5 min</i> | <i>10 min</i> | <i>16 Lane</i> | <i>32 Lane</i> |
| 2 | 12 min | 18 min | 28 min | 32 | 64 |
| 3 | 18 min | 27 min | 42 min | 48 | 96 |
| 4 | 24 min | 36 min | 56 min | 64 | 128 |
| 5 | 30 min | 45 min | 1 hr 10 min | 80 | 160 |
| 6 | 36 min | 54 min | 1 hr 24 min | 96 | 192 |
| 7 | 42 min | 1 hr 3 min | 1 hr 38 min | 112 | 224 |
| 8 | 48 min | 1 hr 12 min | 1 hr 52 min | 128 | 256 |
| 9 | 54 min | 1 hr 21 min | 2 hrs 6 min | 144 | 288 |
| 10 | 60 min | 1 hr 30 min | 2 hrs 20 min | 160 | 320 |
| 11 | 1 hr 6 min | 1 hr 39 min | 2 hrs 34 min | 176 | 352 |
| 12 | 1 hr 12 min | 1 hr 48 min | 2 hrs 48 min | 192 | 384 |
| 13 | 1 hr 18 min | 1 hr 57 min | 3 hrs 2 min | 208 | 416 |
| 14 | 1 hr 24 min | 2 hrs 6 min | 3 hrs 16 min | 224 | 448 |
| 15 | 1 hr 30 min | 2 hrs 15 min | 3 hrs 30 min | 240 | 480 |
| 16 | 1 hr 35 min | 2 hrs 23 min | 3 hrs 43 min | 256 | 512 |
| 17 | 1 hr 41 min | 2 hrs 32 min | 3 hrs 57 min | 272 | 544 |
| 18 | 1 hr 47 min | 2 hrs 41 min | 4 hrs 11 min | 288 | 576 |
| 19 | 1 hr 53 min | 2 hrs 50 min | 4 hrs 25 min | 304 | 608 |
| 20 | 1 hr 59 min | 2 hrs 59 min | 4 hrs 39 min | 320 | 640 |
| Legend: hr – hour; hrs – hours, min – minutes | | | | | |

Table F-56. Stage 1, Day Fire, and Stage 2, Day Fire, Chemical, Biological, Radiological, and Nuclear throughput time schedule

| <i>Phase</i> | <i>Time to Execute</i> | <i>Remarks</i> | | | |
|--|--|---|---------------|--|----------------|
| Stage 1 Day Fire | 3:58 minutes | Includes 3 seconds between engagements and 10 seconds transition to next phase. | | | |
| Stage 2 Day Fire, CBRN Standing, unsupported | 2:02 minutes | Includes 1 minute transition to chemical protective posture and magazine change. | | | |
| Total Time Per Firing Order | 6:00 minutes | Does not include administrative time to move firing order to or from their respective firing positions. | | | |
| <i>Total Number of Firing Orders</i> | <i>Table VI Execution with Administration Time Between Firing Orders</i> | | | <i>Total Firer Throughput based on Range Configuration</i> | |
| | <i>2 min</i> | <i>5 min</i> | <i>10 min</i> | <i>16 Lane</i> | <i>32 Lane</i> |
| 2 | 16 min | 22 min | 32 min | 32 | 64 |
| 3 | 25 min | 34 min | 49 min | 48 | 96 |
| 4 | 33 min | 45 min | 1 hr 5 min | 64 | 128 |
| 5 | 41 min | 56 min | 1 hr 21 min | 80 | 160 |
| 6 | 49 min | 1 hr 7 min | 1 hr 37 min | 96 | 192 |
| 7 | 57 min | 1 hr 18 min | 1 hr 53 min | 112 | 224 |
| 8 | 1 hr 5 min | 1 hr 29 min | 2 hrs 9 min | 128 | 256 |
| 9 | 1 hr 14 min | 1 hr 41 min | 2 hrs 26 min | 144 | 288 |
| 10 | 1 hr 22 min | 1 hr 52 min | 2 hrs 42 min | 160 | 320 |
| 11 | 1 hr 30 min | 2 hrs 3 min | 2 hrs 58 min | 176 | 352 |
| 12 | 1 hr 38 min | 2 hrs 14 min | 3 hrs 14 min | 192 | 384 |
| 13 | 1 hr 46 min | 2 hrs 25 min | 3 hrs 30 min | 208 | 416 |
| 14 | 1 hr 54 min | 2 hrs 36 min | 3 hrs 46 min | 224 | 448 |
| 15 | 2 hrs 3 min | 2 hrs 48 min | 4 hrs 3 min | 240 | 480 |
| 16 | 2 hrs 11 min | 2 hrs 59 min | 4 hrs 19 min | 256 | 512 |
| 17 | 2 hrs 19 min | 3 hrs 10 min | 4 hrs 35 min | 272 | 544 |
| 18 | 2 hrs 27 min | 3 hrs 21 min | 4 hrs 51 min | 288 | 576 |
| 19 | 2 hrs 35 min | 3 hrs 32 min | 5 hrs 7 min | 304 | 608 |
| 20 | 2 hrs 43 min | 3 hrs 43 min | 5 hrs 23 min | 320 | 640 |
| Legend: CBRN – chemical, biological, radiological, and nuclear; hr – hour; hrs – hours, min – minutes | | | | | |

CONDUCT OF THE RANGE

F-91. Leaders instruct Soldiers on the objectives of Table VI and the importance of the functional elements of the shot process. Table VI contains 18 firing tasks with an administrative pause programmed at the end of each phase to facilitate reloading and changing positions.

F-92. Soldiers enter the range and move to their firing points. Once at the firing point, firers assume a standing firing position with automatic rifles in a green status. Soldiers fire Table VI tasks from the ready at varying firing positions throughout the duration of the course of fire, where:

- Tasks 1 through 5 are fired from the prone, unsupported firing position.
- Tasks 6 through 10 are fired from the prone, supported firing position.
- Tasks 11 through 14 are fired from the kneeling, supported firing position.
- Tasks 15 through 18 are fired from the standing, supported firing position.

F-93. Firers must hit a minimum of 28 of the 40 targets presented (70 percent) to successfully pass this event. All firers must also complete Table VI, Qualification, CBRN and Table VI, Qualification, Night, either in simulation (primary) or during live-fire (when authorized simulator systems are unavailable) as part of their overall automatic rifle qualification. The leader annotates the official record of training on DA Form 7801.

F-94. Soldiers begin Table VI training by moving into the firing position following administrative commands from the tower operator. The tower operator uses administrative commands to control the flow of the range, movement of personnel, and other command and control purposes. Table F-57 illustrates the administrative commands for moving a new firing order into position.

Table F-57. Table VI, new firing order, conduct of the range example

| <i>New Firing Order, Conduct of the Range</i> | | | |
|--|---|---|-----------------------|
| | Task | Target | Target Type |
| PRACTICE | New Firing Order | N/A | N/A |
| | Rounds per Target | DODIC | Time (Seconds) |
| | N/A | AB57, AB56 | NO LIMIT |
| TOWER | | SOLDIER ACTION | |
| CONDUCT OF THE RANGE | SECURE YOUR AMMUNITION AND MOVE TO YOUR FIRING POINT | Soldiers secure their weapon in a GREEN status, their training ammunition and move to the designated firing point. | |
| Once all firers are complete, conduct of the range continues. | | | |
| Legend: DODIC – Department of Defense identification code, N/A – not applicable | | | |

F-95. If the unit cannot complete the zero confirmation and application of hold-off tasks during Table IV training, the unit must provide 15-rounds to each firer. The firers conduct the firing order of both tasks prior to beginning Table VI training.

F-96. Units can use the following guide (table F-58, on page F-84) to complete the confirmation at distance task. Firers must have five-rounds to conduct the event. Firers are in a green status at their assigned firing point.

Table F-58. Table IV, engagement 7, confirmation at distance, conduct of fire example

| <i>Table IV, Engagement 7 – Zero Confirmation at Distance</i> | | | |
|--|--|--|-------------------------------------|
|  <p>300 meter (Unit may select different zero range based on their SOP, TTP, or mission requirements).</p> | Zero Confirmation | Target | Target Type |
| | 1 | E-1 or D-1 | Silhouette, kneeling (hit-bob mode) |
| | Rounds per Engagement | DODIC | Time (Seconds) |
| | 5 | AB57 | NO LIMIT |
| TOWER | | SOLDIER ACTION | |
| WEAPONS SAFETY STATUS RED | GO TO PRONE MAKE READY | Soldier moves to the PRONE supported position, establishes a good firing position, and loads one single round magazine. | |
| ALERT | FIRERS | | |
| TARGET DESCRIPTION | TROOP | Soldier acquires the zero confirmation target. | |
| DIRECTION | FRONT | | |
| RANGE | THREE-HUNDRED | Soldier acquires the target and identifies the target's center of visible mass (known as CoVM). | |
| CONTROL | FIVE ROUNDS SLOW FIRE WEAPONS FREE WEAPONS FREE | | |
| EXECUTION | ENGAGE UPON POSITIVE IDENTIFICATION | Soldier begins slow firing a five-round shot group, ensuring the same point of aim for each round. | |
| ONCE ALL FIRERS ARE COMPLETE WITH THE FIVE-ROUND CONFIRMATION AT DISTANCE: | | | |
| TERMINATION | CEASE FIRE CEASE FIRE | The firer's BOLT should be locked to the rear. Tower must assume all weapons are RED. | |
| WEAPONS SAFETY STATUS GREEN | GO GREEN SHOW CLEAR | Soldiers clear their weapons, show clear to the lane safety. | |
| Firer's should achieve four of five hits to successfully complete confirmation at distance. The tower should identify any firer that has not met the confirmation standard and move those Soldiers to the retraining location. | | | |
| Legend: DODIC – Department of Defense identification code, SOP – standard operating procedure, TTP – tactics, techniques, and procedures | | | |

F-97. Once all firers have completed stage 3, they remain in place and await further instructions from the tower operator. The tower operator instructs them to reload and prepare for stage 4. Table F-59 shows an example of the conduct of fire for Table IV, stage 4 training.

Table F-59. Table IV, engagement 8, application of hold-offs, conduct of fire example

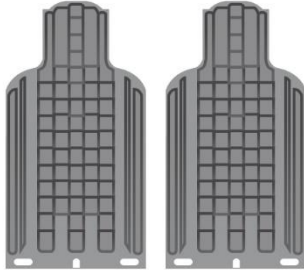
| <i>Table IV, Engagement 8 – Application of Hold-Offs</i> | | | |
|---|--|--|-------------------------------------|
|  <p>100 and 200 meter</p> | Application of Hold-Offs | Target | Target Type |
| | 1 | E-1 or D-1 | Silhouette, kneeling (hit-bob mode) |
| | Rounds per Engagement | DODIC | Time (Seconds) |
| | 10 | AB57 | 55 |
| TOWER | | SOLDIER ACTION | |
| WEAPONS SAFETY STATUS RED | MAKE READY | Soldier remains in the PRONE supported position, establishes a good firing position, and loads one single round magazine. | |
| ALERT | FIRERS | | |
| TARGET DESCRIPTION | TROOPS | Soldier acquires the 100 meter target. | |
| DIRECTION | FRONT | | |
| RANGE | ONE-HUNDRED AND TWO HUNDRED | Soldier acquires the target and identifies the target's center of visible mass (known as CoVM). | |
| CONTROL | FIVE ROUNDS SLOW FIRE WEAPONS FREE WEAPONS FREE | | |
| EXECUTION | ENGAGE UPON POSITIVE IDENTIFICATION | Soldier begins slow firing a five-round shot group, applying the appropriate hold-off at the 100 meter target and again at the 200 meter target. | |
| ONCE ALL FIRERS ARE COMPLETE WITH THE 10-ROUND APPLICATION OF HOLD-OFF: | | | |
| TERMINATION | CEASE FIRE CEASE FIRE | The firer's BOLT should be locked to the rear. Tower must assume all weapons are RED. | |
| WEAPONS SAFETY STATUS GREEN | GO GREEN SHOW CLEAR | Soldiers clear their weapons, show clear to the lane safety. | |
| Firer's should achieve four of five hits on each target to successfully complete application of hold-offs. The tower should identify any firer that has not met the standard and move those Soldiers to the retraining location. | | | |
| Legend: DODIC – Department of Defense identification code, SOP – standard operating procedure, TTP – tactics, techniques, and procedures, | | | |

F-98. The following engagement sequence guide initiates the Table VI scenario elements. Tables F-60 through F-63, on pages F-87 through F-89, provide the engagement sequence with a generic conduct of fire process for the tower operator.

Table F-60. Table VI, engagement 1 through 5, conduct of fire example

| <i>Engagement 1 through 5 – Day, Prone, Unsupported</i> | | | |
|---|--|--|-----------------------|
| | Engagement | Target | Target Type |
| | 1 through 5 | E-1 F-1 | Point |
| | Rounds | DODIC | Time (Seconds) |
| | 50-round belt | AB56 | 67 |
| TOWER | | SOLDIER ACTION | |
| WEAPONS SAFETY STATUS RED | MAKE READY | Soldier assumes a STANDING UNSUPPORTED firing position and loads one 50-round belt of ammunition. | |
| ALERT | CONTACT | | |
| TARGET DESCRIPTION | TROOPS | | |
| DIRECTION | FRONT | | |
| RANGE | MID-RANGE | | |
| METHOD | NEAR TO FAR | | |
| CONTROL | WEAPONS FREE WEAPONS FREE | Soldier moves the weapon from SAFE to FIRE, and begins the target acquisition process. | |
| EXECUTION | ENGAGE UPON POSITIVE IDENTIFICATION | Soldier engages the first target from the STANDING UNSUPPORTED firing position then goes to the PRONE UNSUPPORTED firing position. Soldier acquires, prioritizes, and engages targets with one killing burst per target. | |
| TOWER AWAITS COMPLETION OF ENGAGEMENT 5 THEN PROCEEDS IMMEDIATELY | | | |
| WEAPONS SAFETY STATUS REMAINS RED | | | |
| <p>Note: There is a 5-second delay between the first and second engagement to allow the Soldier to go to prone. There is a 3-second delay between all other engagements in this table. There is a 10-second delay at the end of the phase to support changing ammunition and changing the firing position.</p> | | | |
| <p>Legend: DODIC – Department of Defense identification code, m – meter</p> | | | |

Table F-61. Table VI, engagement 6 through 10, conduct of fire example

| <i>Engagement 6 through 10 – Day, Prone, Supported</i> | | | |
|---|---|--|-----------------------|
| | Engagement | Target | Target Type |
| | 6 through 10 | E-1 | Point |
| | Rounds | DODIC | Time (Seconds) |
| | 50-round belt | AB56 | 63 |
| TOWER | | SOLDIER ACTION | |
| WEAPONS SAFETY STATUS RED | <i>Although the firer's bolt should be locked to the rear, the tower must treat all weapons as if in a RED status</i> | Soldier remains in the PRONE position, at the READY and may RELOAD one 50-round belt or await instructions. | |
| CONTROL | GO TO PRONE SUPPORTED RELOAD | The Soldier conducts a RELOAD and establishes a PRONE, SUPPORTED position and prepares to engage. | |
| TOWER AWAITS THE END OF THE 10-SECOND TRANSITION THEN PROCEEDS | | | |
| WEAPONS SAFETY STATUS REMAINS RED | | | |
| EXECUTION | ENGAGE UPON POSITIVE IDENTIFICATION | Soldier acquires, prioritizes, and engages targets with one killing burst per target. | |
| TOWER AWAITS COMPLETION OF ENGAGEMENT 10 THEN PROCEEDS IMMEDIATELY | | | |
| WEAPONS SAFETY STATUS REMAINS RED | | | |
| Note: There is a 3-second delay between all engagements. There is a 10-second delay at the end of the phase to support changing ammunition and changing the firing position. | | | |
| Legend: DODIC – Department of Defense identification code | | | |

Table F-62. Table VI, engagement 11 through 14, conduct of fire example

| <i>Engagement 11 through 14 – Kneeling, Supported</i> | | | |
|---|--|---|-----------------------|
| | Engagement | Target | Target Type |
| | 11 through 14 | E-1 F-1 | Point |
| | Rounds | DODIC | Time (Seconds) |
| | 50 round belt | AB56 | 59 |
| TOWER | | SOLDIER ACTION | |
| WEAPONS SAFETY STATUS RED | <i>Although the firer's bolt should be locked to the rear, the tower must treat all weapons as if in a RED status.</i> | Soldier remains at the READY and may RELOAD one 50-round belt or await instructions. | |
| CONTROL | RELOAD MAGAZINE FIGHT UP | The Soldier conducts an emergency RELOAD of one 50-round belt and assumes the KNEELING, SUPPORTED position. | |
| TOWER AWAITS THE END OF THE 10-SECOND TRANSITION THEN PROCEEDS | | | |
| WEAPONS SAFETY STATUS REMAINS RED | | | |
| EXECUTION | ENGAGE UPON POSITIVE IDENTIFICATION | Soldier acquires, prioritizes, and engages targets with one killing burst per target. | |
| TOWER AWAITS COMPLETION OF ENGAGEMENT 14 THEN PROCEEDS | | | |
| WEAPONS SAFETY STATUS REMAINS RED | | | |
| Note: There is a 3-second delay between all engagements. There is a 10-second delay at the end of the phase to support changing ammunition and changing the firing position. | | | |
| Legend: DODIC – Department of Defense identification code | | | |

Table F-63. Table VI, engagement 15 through 18, conduct of fire example

| <i>Engagement 15 through 18 – Standing, Supported</i> | | | |
|---|--|---|-----------------------|
| | Engagement | Target | Target Type |
| | 15 through 18 | E-1 F-1 | Point |
| | Rounds | DODIC | Time (Seconds) |
| | 50-round belt | AB56 | 51 |
| TOWER | | SOLDIER ACTION | |
| WEAPONS SAFETY STATUS RED | <i>Although the firer's bolt should be locked to the rear, the tower must treat all weapons as if in a RED status.</i> | Soldier remains at the READY and may RELOAD one 50-round ammunition belt or await instructions. | |
| CONTROL | RELOAD FIGHT UP | The Soldier conducts a RELOAD of one 50-round ammunition belt and assumes the STANDING, SUPPORTED position. | |
| TOWER AWAITS THE END OF THE 10-SECOND TRANSITION THEN PROCEEDS | | | |
| WEAPONS SAFETY STATUS REMAINS RED | | | |
| EXECUTION | ENGAGE UPON POSITIVE IDENTIFICATION | Soldier acquires, prioritizes, and engages targets with one killing burst per target. | |
| TOWER AWAITS COMPLETION OF ENGAGEMENT 18 THEN PROCEEDS | | | |
| WEAPONS SAFETY STATUS REMAINS RED | | | |
| <p>Note: There is a 3-second delay between all engagements. This completes the day firing phase for Table VI training. <i>There are no alibis authorized.</i> Any remaining ammunition is returned to the ammunition issue point for redistribution.</p> | | | |
| <p>Legend: DODIC – Department of Defense identification code</p> | | | |

F-99. A lane safety clears the firers upon their completion of Table VI tasks and collecting their dunnage. A lane safety verifies the clearing prior to the Soldier moving from their firing point. Once the lane safety clears all Soldiers, the lane safety communicates the WSS to the tower operator and the tower operator issues an administrative command to move the completed Soldiers off the range. Table F-64 is an example of this command.

Table F-64. Table VI, completed firing order, conduct of the range example

| <i>Firing Order Complete</i> | | | |
|--|--|--|-----------------------|
| | Task | Target | Target Type |
| FIRING ORDER COMPLETE | Completed Firing Order | N/A | N/A |
| | Rounds per Target | DODIC | Time (Seconds) |
| | N/A | N/A | NO LIMIT |
| TOWER | SOLDIER ACTION | | |
| TOWER MUST ASSUME ALL FIRERS' WEAPON SAFETY STATUS ARE RED | | | |
| TERMINATION | CEASE FIRE CEASE FIRE | Soldiers stop firing and place weapons on SAFE. | |
| WEAPONS SAFETY STATUS GREEN | GO GREEN GO GREEN ONCE VERIFIED BY THE RSO, SECURE WEAPON | Soldiers clear their weapon and wait to be inspected by a lane safety. | |
| CONDUCT OF THE RANGE | FIRERS SECURE YOUR DUNNAGE MOVE TO THE BASELINE. | Firers secure weapon and ammunition dunnage and move to the designated location. | |
| Once all firers return to the baseline, tower directs the firing order off the range. | | | |
| Legend: DODIC – Department of Defense identification code, N/A – not applicable, RSO – range safety officer | | | |

F-100. As soon as the lane safety clears the completed firing order, the tower operator moves a new firing order into position and the process repeats itself until all firers have completed Table VI, Qualification event successfully. The tower operator moves all identified firers that require retraining to the appropriate concurrent training location.

STAGE 2 – DAY FIRE, CHEMICAL, BIOLOGICAL, RADIOLOGICAL, AND NUCLEAR

F-101. Stage 2, Day Fire, CBRN is a required automatic rifle qualification event. Leaders use the event to train and evaluate the firer's ability to engage targets while operating with individual chemical protective equipment. At a minimum, Soldiers are required to fire this course of fire while wearing individual combat equipment and a protective mask with hood. All Soldier's assigned an automatic rifle must complete this course of fire as part of their qualification based on their access to primary simulations systems (see table F-65.)

Table F-65. Stage 2, Day Fire, Chemical, Biological, Radiological, and Nuclear, training environment requirement

| <i>Supported / Available System</i> | <i>Authorized As</i> | <i>Qualification Environment Required</i> | |
|---|----------------------|---|-------------------------|
| | | <i>Virtual</i> | <i>Live (Live-Fire)</i> |
| Soldier and squad virtual training system (S / SVT) | Primary | X | |
| Engagement skills trainer (EST) | Alternate | X | |
| None Available | Live-Fire | | X |

F-102. All firers that have access to an authorized primary or alternate simulation system are not authorized training ammunition to conduct this event in a live environment under live-fire conditions. Units that have secured resources may use the live-fire CBRN qualification for record.

F-103. Stage 2 is only for units that do not have access to an authorized simulator system based on the system's basis of issue plan. Failure to coordinate for the appropriate system or failure to conduct the CBRN qualification in a designated and authorized system does not authorize the use of training ammunition for this event.

AMMUNITION

F-104. To effectively plan and forecast for sufficient training ammunition, the unit will use the ammunition requirements listed in table F-66. Units will need to identify the total number of firers and should plan for unscheduled firers and necessary retraining by increasing their forecasted training ammunition as appropriate. Firers place ammunition in their ammunition pouches. Staging or pre-positioning ammunitions is not authorized for the conduct of Table VI, CBRN, Day training.

Table F-66. Stage 2, Day Fire, Chemical, Biological, Radiological, and Nuclear ammunition requirement

| <i>Stage 2</i> | <i>DODIC</i> | <i>Nomenclature</i> | <i>Quantity</i> | <i>Remarks</i> |
|--|--------------|---------------------------------------|-----------------|---|
| Day Fire, CBRN | AB56 | CTG, 5.56mm, ball, M855A1 EPR, linked | 50 | A 3 to 5 round killing burst is authorized for each target presented. |
| Legend: CBRN – chemical, biological, radiological, and nuclear; CTG – cartridge, DODIC – Department of Defense identification code, EPR – enhanced performance round, mm – millimeter | | | | |

SCENARIO ENGAGEMENTS

F-105. Targets are presented to the firer in single and multiple target arrays. Targets are presented so that 90-percent of the target is clearly visible to the firer from the expected or planned firing position. Targets are exposed to the firer based on the number of targets presented during the engagement as follows:

- Single target engagements are exposed for 5 seconds.
- Double target engagements are exposed for 8 seconds.

F-106. There is a three-second delay during day fire between each engagement. Table F-67 shows the scenario engagement sequence for CBRN qualification. The leader annotates the official record of training on DA Form 7801.

Table F-67. Stage 2, Day Fire, Chemical, Biological, Radiological, and Nuclear, target engagement sequence

| <i>Stage 2, Day Fire, CBRN, Standing, Unsupported</i> | | | |
|--|--------------------|---------------|----------------------|
| <i>Engagement</i> | <i>Target Type</i> | <i>Range</i> | <i>Exposure Time</i> |
| 1 | F-type | 50 m RIGHT | 5 sec |
| 2 | E-type | 100 m | 8 sec |
| | E-type | 50 m LEFT | |
| 3 | F-type | 50 m RIGHT | 8 sec |
| | E-type | 150 m | |
| 4 | E-type | 200 m | 5 sec |
| 5 | E-type | 100 m | 5 sec |
| 6 | E-type | 150 m | 5 sec |
| 7 | F-type | 50 m RIGHT | 8 sec |
| | E-type | 50 m LEFT | |
| Standing, Unsupported, Time per Firing Order Total | | | 62 sec |
| Note: There is a 3-second delay between all engagements. | | | |
| Legend: CBRN – chemical, biological, radiological, and nuclear, m – meters, sec – seconds | | | |

F-107. Table F-68 provides the stage 2, day fire, CBRN throughput schedule. Table F-67 is a guide to units that portrays the overall efficiency of the range facility when conducting the training event. It provides the overall throughput timetable, based on the time the unit requires to remove one firing order from the firing positions and move the next firing order forward.

F-108. Three general movement schedules are available to administer firing order placements on the range, 2 minutes, 5 minutes, and 10 minutes. The more proficient a unit is at operating a small arms range facility, the greater the firer throughput on the facility. This schedule does not include time required for retraining, refires, or firers who have persistent problems using a reticle.

Table F-68. Stage 2, Day Fire, Chemical, Biological, Radiological, and Nuclear throughput time schedule



| Stage | | Time to Execute | | | Remarks | |
|--|--|------------------------|---------------|---|---|--|
| Stage 2, Day, CBRN, Standing, unsupported | | 1:02 minute | | | Includes 3 seconds between engagements and 10 seconds transition to next phase. | |
| Total time per firing order | | 1:02 minute | | | Does not include administrative time to move firing order to or from their respective firing positions. | |
| Total Number of Firing Orders | Table VI Execution with Administration Time Between Firing Orders | | | Total Firing Throughput based on Range Configuration | | |
| | 2 min | 5 min | 10 min | 16 Lane | 32 Lane | |
| 2 | 6 min | 12 min | 22 min | 32 | 64 | |
| 3 | 10 min | 19 min | 34 min | 48 | 96 | |
| 4 | 13 min | 25 min | 45 min | 64 | 128 | |
| 5 | 16 min | 31 min | 56 min | 80 | 160 | |
| 6 | 19 min | 37 min | 1 hr 7 min | 96 | 192 | |
| 7 | 22 min | 43 min | 1 hr 18 min | 112 | 224 | |
| 8 | 26 min | 50 min | 1 hr 30 min | 128 | 256 | |
| 9 | 29 min | 56 min | 1 hr 41 min | 144 | 288 | |
| 10 | 32 min | 1 hr 2 min | 1 hr 52 min | 160 | 320 | |
| 11 | 35 min | 1 hr 8 min | 2 hrs 3 min | 176 | 352 | |
| 12 | 38 min | 1 hr 14 min | 2 hrs 14 min | 192 | 384 | |
| 13 | 42 min | 1 hr 21 min | 2 hrs 26 min | 208 | 416 | |
| 14 | 45 min | 1 hr 27 min | 2 hrs 37 min | 224 | 448 | |
| 15 | 48 min | 1 hr 33 min | 2 hrs 48 min | 240 | 480 | |
| 16 | 51 min | 1 hr 39 min | 2 hrs 59 min | 256 | 512 | |
| 17 | 54 min | 1 hr 45 min | 3 hrs 10 min | 272 | 544 | |
| 18 | 58 min | 1 hr 52 min | 3 hrs 22 min | 288 | 576 | |
| 19 | 1 hr 1 min | 1 hr 58 min | 3 hrs 33 min | 304 | 608 | |
| 20 | 1 hr 4 min | 2 hrs 4 min | 3 hrs 44 min | 320 | 640 | |
| Legend: CBRN – chemical, biological, radiological, and nuclear; hr – hour; hrs – hours, min – minutes | | | | | | |

CONDUCT OF THE RANGE

F-109. Leaders instruct Soldiers on the objectives of day fire, CBRN and the importance of the functional elements of the shot process. Units conduct the elements listed in Table VI, Qualification, Day Fire, CBRN in a single scenario, containing single and double threat presentations. Firers must hit a minimum of 7 of the 10 targets presented (70 percent) to successfully pass this table (receive a GO).

F-110. Soldiers begin day fire, CBRN by moving into the firing position following administrative commands from the tower operator. Soldiers enter the range and move to their firing points. Once at the firing point, firers assume a standing, unsupported firing position. Soldiers fire from the ready throughout the duration of the course of fire according to tasks listed in Table VI, Qualification, Day Fire, CBRN. Table F-69 is an example of the administrative commands for moving a new firing order into position.

Table F-69. Stage 2, Day Fire, Chemical, Biological, Radiological, and Nuclear, new firing order conduct of the range example

| <i>New Firing Order, Conduct of the Range</i> | | | |
|---|--------------------------|---|-----------------------|
|  <p style="text-align: center;">CBRN</p> | Engagement | Target | Target Type |
| | New Firing Order | N/A | N/A |
| | Rounds per Target | DODIC | Time (Seconds) |
| | N/A | AB56 | NO LIMIT |
| TOWER | | SOLDIER ACTION | |
| CONDUCT OF THE RANGE FIRERS, SECURE YOUR WEAPON AND AMMUNITION ONCE COMPLETE, MOVE TO YOUR FIRING POINT | | Soldiers secure their weapon, ammunition, and chemical protective mask and move to the designated firing point. | |
| ONCE FIRERS ARE SET AT THEIR FIRING POINT, THE TOWER CONTINUES. | | | |
| CONDUCT OF THE RANGE | | FIRERS, CHEMICAL AGENTS HAVE BEEN REPORTED IN YOUR AREA GAS GAS GAS  | |
| | | Soldiers don their protective equipment. | |
| ONCE ALL FIRERS HAVE COMPLETED DONNING PROTECTIVE GEAR, THE TOWER CONTINUES. | | | |
| Legend: CBRN – chemical, biological, radiological and nuclear; DODIC – Department of Defense identification code, N/A – not applicable | | | |

F-111. Once the tower operator confirms all firers are at the appropriate firing point and in the proper MOPP level, the tower operator proceeds to the first engagement. Table VI, Qualification, CBRN has 10 engagements that use a single 50-round belt of ammunition. Table F-70 provides the commands for tasks 1 through 7. (See table F-71, on page F-92, also.)

Table F-70. Stage 2, Day Fire, Chemical, Biological, Radiological, and Nuclear, conduct of fire

| <i>Stage 2, Day Fire, CBRN, Standing, Unsupported</i> | | | |
|---|--|--|-----------------------|
| | Engagement | Target | Target Type |
| | 1 to 7 | E-1 F-1 | Point |
| | Rounds per Target | DODIC | Time (Seconds) |
| | 50-round belt | AB56 | 62 |
| TOWER | SOLDIER ACTION | | |
| WEAPONS SAFETY STATUS RED | FIRERS MAKE READY | Soldier assumes the standing unsupported firing position, loads one 50-round ammunition belt, ensures the weapon is on SAFE, and remains at the READY. | |
| ALERT | CONTACT | | |
| TARGET DESCRIPTION | MULTIPLE TROOPS | | |
| DIRECTION | FRONT | | |
| RANGE | MID-RANGE | | |
| METHOD | NEAR TO FAR | | |
| CONTROL | WEAPONS FREE WEAPONS FREE | Soldier moves the weapon from SAFE to FIRE, and begins the target acquisition process. | |
| EXECUTION | ENGAGE WHEN POSITIVELY IDENTIFIED | Soldier acquires targets, prioritizes targets, and engages targets with one killing burst per target. | |
| ONCE ALL FIRERS ARE COMPLETE, TOWER CONTINUES. | | | |
| WEAPONS SAFETY STATUS REMAINS RED | | | |
| Note: There is a 3-second delay between all engagements. | | | |
| Legend: CBRN – chemical, biological, radiological, and nuclear, DODIC – Department of Defense identification coder | | | |

Table F-71. Stage 2, Day Fire, Chemical, Biological, Radiological, and Nuclear, completed firing order, conduct of the range example

| <i>Completed Firing Order, Conduct of the Range</i> | | | |
|--|--|--|-----------------------|
|  <p style="text-align: center;">CBRN</p> | Engagement | Target | Target Type |
| | Completed Firing Order | N/A | N/A |
| | Rounds per Target | DODIC | Time (Seconds) |
| | N/A | N/A | NO LIMIT |
| TOWER | SOLDIER ACTION | | |
| TOWER MUST ASSUME ALL FIRERS WEAPONS SAFETY STATUS IS RED | | | |
| TERMINATION | CEASE FIRE CEASE FIRE | Soldiers stop firing and place weapons on SAFE. | |
| WEAPONS SAFETY STATUS GREEN | GO GREEN GO GREEN | Soldiers clear their weapon and wait to be inspected by a lane safety. | |
| ONCE TOWER CONFIRMS ALL WEAPONS ARE GREEN AND CLEAR, TOWER CONTINUES | | | |
| CONDUCT OF THE RANGE | ALL CLEAR ALL CLEAR SECURE YOUR DUNNAGE MOVE TO THE ENTRY CONTROL POINT | Firers unmask, secure their weapon, ammunition, and dunnage. Once complete, they move to the range's entry control point. | |
| Tower waits for all Soldiers to reach the entry control point (ECP) prior to moving the next firing order into position. | | | |
| Legend: CBRN – chemical, biological, radiological, and nuclear, DODIC – Department of Defense identification code, N/A – not applicable | | | |

F-112. A lane safety clears the firers upon their completion of stage 2, day fire, CBRN and collecting their dunnage from the firing position. The RSO or lane safety verifies weapons cleared prior to the Soldier moving from the firing point. Once the lane safety clears all Soldiers, the lane safety communicates the green weapons safety status to the tower operator. The tower operator then issues an administrative command directing the Soldiers off the range.

STAGE 3 – NIGHT FIRE

F-113. Leaders use Stage 3, Automatic Rifle, Table VI, Qualification, Night Fire to train the firer to engage targets during periods of limited visibility while wearing night vision goggles (unassisted). At a minimum, Soldiers are required to fire this course of fire while wearing individual combat equipment and their assigned night vision device. Targets are placed in a tactical array at close quarter's distances.

F-114. All Soldier's assigned an automatic rifle must complete this course of fire as part of their qualification based on their access to primary simulations systems. (See table F-72.)

Table F-72. Automatic Rifle, Table VI, Qualification, Night Fire, execution based on virtual system availability

| <i>Supported / Available System</i> | <i>Authorized As</i> | <i>Environment Training Conducted</i> | |
|---|----------------------|---------------------------------------|-------------------------|
| | | <i>Virtual</i> | <i>Live (Live-Fire)</i> |
| Soldier and squad virtual training system (S / SVT) | Primary | X | |
| Engagement skills trainer (EST) | Alternate | X | |
| None available | None | | X |

AMMUNITION

F-115. To effectively plan and forecast for sufficient training ammunition, the unit uses the ammunition requirements listed in table F-73. Units need to identify the total number of firers and should plan for unscheduled firers and necessary retraining by increasing their forecasted training ammunition, as appropriate. Firers place ammunition in their ammunition pouches. Staging or pre-positioning ammunition is not authorized for the conduct of Table VI, Night Fire tasks.

Table F-73. Automatic Rifle, Table VI, Night Fire ammunition requirements

| <i>Training Event</i> | <i>DODIC</i> | <i>Nomenclature</i> | <i>Quantity</i> | <i>Remarks</i> |
|--|--------------|--|-----------------------------|---|
| Qualification, Night Fire | AB73 | CTG, 5.56mm, 4 ball, M855A1, 1 tracer, M856A1, EPR, linked | 100 (2 each 50-round belts) | One 3 to 5 round killing burst is authorized for each target presented. |
| Legend: CTG – cartridge, DODIC – Department of Defense identification code, EPR – enhanced performance round, mm – millimeter | | | | |

SCENARIO ENGAGEMENTS

F-116. Targets are presented to the firer in single and multiple target arrays. Targets are presented such that 90-percent of the target is clearly visible to the firer from the expected or planned firing position. Targets are exposed to the firer based on the number of targets presented during the engagement:

- Single target engagements are exposed for 8 seconds.
- Double target engagements are exposed for 12 seconds.
- Triple target engagements are exposed for 16 seconds.

F-117. There is a 5-second delay between each engagement. After the initial kneeling, supported phase, there is a 15-second transition delay providing the firer with the time to conduct an emergency reload and make ready. Table F-74, on page F-98, shows the scenario engagement sequence for CBRN qualification.

Table F-74. Stage 3, Night Fire, target engagement sequence

| <i>Automatic Rifle, Table VI, Qualification, Stage 3, Night Fire, Kneeling, Supported</i> | | | |
|--|--------------------|---------------|----------------------|
| <i>Engagement</i> | <i>Target Type</i> | <i>Range</i> | <i>Exposure Time</i> |
| 1 | F-type | 50 m RIGHT | 8 sec |
| 2 | E-type | 50 m LEFT | 8 sec |
| 3 | F-type | 50 m RIGHT | 8 sec |
| 4 | E-type | 50 m LEFT | 12 sec |
| | E-type | 100 m | |
| 5 | E-type | 50 m LEFT | 12 sec |
| | E-type | 100 m | |
| 6 | F-type | 50 m RIGHT | 16 sec |
| | E-type | 50 m LEFT | |
| | E-type | 100 m | |
| Prone, Unsupported, Time per Firing Order Total | | | 104 seconds |
| <p>Note: There is a 5-second delay between all engagements. A 15-second delay time is incorporated at the end of engagement 6 to facilitate reload.</p> | | | |
| <p>Legend: m – meters; sec – seconds</p> | | | |

Table F-74. Stage 3, Night Fire, target engagement sequence (continued)

| <i>Automatic Rifle, Table VI, Qualification, Stage 3, Night Fire, Kneeling, Supported, continued</i> | | | |
|--|--------------------|---------------|----------------------|
| <i>Engagement</i> | <i>Target Type</i> | <i>Range</i> | <i>Exposure Time</i> |
| 7 | F-type | 50 m RIGHT | 12 sec |
| | E-type | 50 m LEFT | |
| 8 | E-type | 50 m LEFT | 12 sec |
| | E-type | 100 m | |
| 9 | F-type | 50 m RIGHT | 16 sec |
| | E-type | 50 m LEFT | |
| | E-type | 100 m | |
| 10 | F-type | 50 m RIGHT | 16 sec |
| | E-type | 50 m LEFT | |
| | E-type | 100 m | |
| Prone, Unsupported, Time per Firing Order Total | | | 71 seconds |
| Note: There is a 5-second delay between all engagements. | | | |
| Legend: m – meters; sec – seconds | | | |

F-118. Table F-75, on page F-100, is the Table VI, Qualification, Night Fire throughput schedule. Table F-75 is a guide for units. The table portrays the overall efficiency of the range facility when conducting the training event. Table F-75 is the overall throughput timetable, based on the time the unit requires to remove one firing order from the firing positions and move the next firing order forward.

F-119. Three general movement schedules are available to administer firing order placements on the range, 2 minutes, 5 minutes, and 10 minutes. The more proficient a unit is at operating a small arms range facility, the greater the firer throughput on the facility. The schedule does not include time required for retraining, refires, or firers who have persistent problems using a reticle.

Table F-75. Stage 3, Night Fire and Stage 4, Night Fire, Chemical, Biological, Radiological, and Nuclear throughput time schedule

| <i>Phase</i> | | <i>Time to Execute</i> | | <i>Remarks</i> | |
|---|--|------------------------|---------------|---|----------------|
| Stage 3, Night Fire, Kneeling, Supported | | 1:44 minute | | Includes 5 seconds between engagements and 15 seconds transition to next phase. | |
| Stage 3, Night Fire, Kneeling, Supported | | 1:11 minute | | | |
| Stage 4, Night Fire, CBRN, Standing, Unsupported | | 2:08 minute | | Includes 1 minute transition to CBRN. | |
| Total Time Per Firing Order | | 5:03 minutes | | Does not include administrative time to move firing order to or from their respective firing positions. | |
| <i>Total Number of Firing Orders</i> | <i>Night Fire Execution with Administration Time Between Firing Orders</i> | | | <i>Total Firer Throughput based on Range Configuration</i> | |
| | <i>2 min</i> | <i>5 min</i> | <i>10 min</i> | <i>16 Lane</i> | <i>32 Lane</i> |
| 2 | 14 min | 20 min | 30 min | 32 | 64 |
| 3 | 21 min | 30 min | 45 min | 48 | 96 |
| 4 | 28 min | 40 min | 1 hr 0 min | 64 | 128 |
| 5 | 35 min | 50 min | 1 hr 15 min | 80 | 160 |
| 6 | 42 min | 1 hr 0 min | 1 hr 30 min | 96 | 192 |
| 7 | 49 min | 1 hr 10 min | 1 hr 45 min | 112 | 224 |
| 8 | 56 min | 1 hr 20 min | 2 hrs 0 min | 128 | 256 |
| 9 | 1 hr 3 min | 1 hr 30 min | 2 hrs 15 min | 144 | 288 |
| 10 | 1 hr 11 min | 1 hr 41 min | 2 hrs 31 min | 160 | 320 |
| 11 | 1 hr 18 min | 1 hr 51 min | 2 hrs 46 min | 176 | 352 |
| 12 | 1 hr 25 min | 2 hrs 1 min | 3 hrs 1 min | 192 | 384 |
| 13 | 1 hr 32 min | 2 hrs 11 min | 3 hrs 16 min | 208 | 416 |
| 14 | 1 hr 39 min | 2 hrs 21 min | 3 hrs 31 min | 224 | 448 |
| 15 | 1 hr 46 min | 2 hrs 31 min | 3 hrs 46 min | 240 | 480 |
| 16 | 1 hr 53 min | 2 hrs 41 min | 4 hrs 1 min | 256 | 512 |
| 17 | 1 hr 60 min | 2 hrs 51 min | 4 hrs 16 min | 272 | 544 |
| 18 | 2 hrs 7 min | 3 hrs 1 min | 4 hrs 31 min | 288 | 576 |
| 19 | 2 hrs 14 min | 3 hrs 11 min | 4 hrs 46 min | 304 | 608 |
| 20 | 2 hrs 21 min | 3 hrs 21 min | 5 hrs 1 min | 320 | 640 |
| Note: This throughput schedule includes Stage 4, Night Fire, CBRN, for planning purposes to capture the full night fire requirement. | | | | | |
| Legend: CBRN – chemical, biological, radiological, and nuclear; hr – hour; hrs – hours, min – minutes | | | | | |

CONDUCT OF THE RANGE

F-120. Leaders instruct Soldiers on the objectives of stage 3, night fire and the importance of the functional elements of the shot process. Units conduct Table VI, Qualification, Stage 3, Night Fire training in two administrative and 10 firing tasks. Firers must hit a minimum of 14 of the 20 targets presented (70 percent) to successfully pass this table.

F-121. Soldiers begin Table VI, Night by moving into the firing position following administrative commands from the tower operator. Soldiers enter the range and move to their firing points. Once the Soldiers are at the firing point, they assume a standing firing position with automatic rifles in a green status. Soldiers fire according to Table VI, Qualification, Night Fire tasks from the ready throughout the duration of the course of fire.

F-122. The tower operator uses administrative commands to control the flow of the range, movement of personnel, and other command and control purposes. Table F-76 provides an example of the administrative commands for moving a new firing order into position.

Table F-76. Stage 3, Night Fire, new firing order, conduct of the range example

| <i>New Firing Order, Conduct of the Range</i> | | | |
|--|---|---|-----------------------|
| NIGHT FIRE | Engagement | Target | Target Type |
| | New Firing Order | N/A | N/A |
| | Rounds per Target | DODIC | Time (Seconds) |
| | N/A | AB73 | NO LIMIT |
| TOWER | | SOLDIER ACTION | |
| FIRERS | | | |
| CONDUCT OF THE RANGE | SECURE YOUR WEAPON AND AMMUNITION | Soldiers secure their weapon, ammunition, and night vision equipment and move to the designated firing point. | |
| | ONCE COMPLETE MOVE TO YOUR FIRING POINT | | |
| ONCE ALL FIRERS ARE AT THEIR FIRING POSITIONS, THE TOWER CONTINUES. | | | |
| Legend: DODIC – Department of Defense identification code, N/A – not applicable | | | |

F-123. As soon as the tower operator confirms all firers are at the appropriate firing point, they proceed to the next engagement. Table VI, Qualification, Stage 3, Night Fire has 10 firing tasks. Table F-77, on page F-102, lists the commands for task 1 through 10. Two 50-round belts of ammunition are required to fire engagements 1 through 10 in Table VI, Qualification, Night Fire.

Table F-77. Stage 3, Night Fire engagement 1 through 6

| <i>Stage 3, Night Fire, Kneeling, Supported</i> | | | |
|--|--|---|-----------------------|
|  | Engagement | Target | Target Type |
| | 1 to 6 | E-1 F-1 | Point |
| | Rounds per Target | DODIC | Time (Minutes) |
| | 3 to 5 rounds 50-round belt | AB73 | 1:44 |
| TOWER | | SOLDIER ACTION | |
| FIRERS, WEAPONS SAFETY STATUS RED SECURE ONE FIFTY-ROUND BELT MAKE READY Soldier assumes the kneeling supported firing position, loads one 50-round ammunition belt, ensures the weapon is on SAFE, and remains at the READY. | | | |
| ALERT | CONTACT | | |
| TARGET DESCRIPTION | MULTIPLE TROOPS | | |
| DIRECTION | FRONT | | |
| RANGE | MID-RANGE | | |
| METHOD | NEAR TO FAR | | |
| CONTROL | WEAPONS FREE WEAPONS FREE | Soldier moves the weapon from SAFE to FIRE, and begins the target acquisition process. | |
| EXECUTION | ENGAGE WHEN POSITIVELY IDENTIFIED | Soldier acquires, prioritizes, and engages targets with one killing burst per target. | |
| ONCE ALL FIRERS ARE COMPLETE, TOWER CONTINUES. | | | |
| Note: There is a 5-second delay between all engagements. There is a 15-second delay at the end of the phase to support changing ammunition. | | | |
| Legend: DODIC – Department of Defense identification code | | | |

Table F-77. Stage 3, Night Fire, conduct of fire (continued)

| <i>Stage 3, Night Fire, Kneeling, Supported</i> | | | |
|---|---|--|-----------------------|
|  | Engagement | Target | Target Type |
| | 7 to 10 | E-1 F-1 | Point |
| | Rounds per Target | DODIC | Time (Minutes) |
| | 3-5 rounds 50-round belt | AB73 | 1:11 |
| TOWER | | SOLDIER ACTION | |
| WEAPONS SAFETY STATUS RED | <i>Although the firer's bolt should be locked to the rear, the tower must treat all weapons as if in a RED status</i> | Soldier remains in the KNEELING, SUPPORTED position at the READY and may RELOAD or await instruction. | |
| CONTROL | RELOAD | The Soldier conducts a RELOAD and prepares to engage. | |
| TOWER AWAITS THE END OF THE 15-SECOND TRANSITION THEN PROCEEDS | | | |
| WEAPONS SAFETY STATUS REMAINS RED | | | |
| EXECUTION | ENGAGE WHEN POSITIVELY IDENTIFIED | Soldier acquires targets, prioritizes targets, and engages targets with one killing burst per target. | |
| ONCE ALL FIRERS ARE COMPLETE, TOWER CONTINUES. | | | |
| WEAPONS SAFETY STATUS REMAINS RED | | | |
| Note: There is a 5-second delay between all engagements. | | | |
| Legend: DODIC – Department of Defense identification code | | | |

F-124. Upon the firers' completion of Table VI, Qualification, Stage 3, Night Fire tasks and collecting their dunnage, the lane safety clears them. A lane safety verifies the weapons clearing prior to the Soldiers moving from the firing point. Once the Soldiers have cleared, the lane safety communicates the WSS to the tower operator and the tower operator issues an administrative command moving the completed Soldiers off the range. Table F-78, on page F-104, is an example of this command.

Table F-78. Stage 3, Night Fire, completed firing order, conduct of the range example

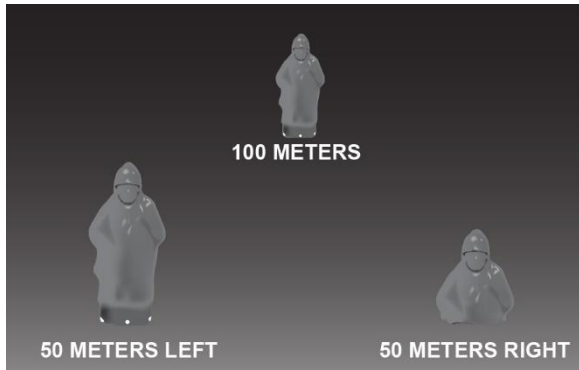
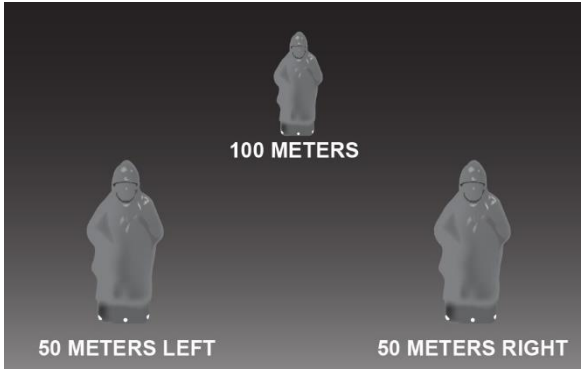
| <i>Completed Firing Order, Conduct of the Range</i> | | | |
|--|---|--|----------------|
| NIGHT FIRE | Engagement | Target | Target Type |
| | Completed Firing Order | N/A | N/A |
| | Rounds per Target | DODIC | Time (Seconds) |
| | N/A | N/A | NO LIMIT |
| TOWER | SOLDIER ACTION | | |
| ALL FIRERS WEAPONS SAFETY STATUS IS RED | | | |
| TERMINATION | CEASE FIRE CEASE FIRE | Soldiers stop firing and place weapons on SAFE. | |
| WEAPONS SAFETY STATUS GREEN | GO GREEN GO GREEN ONCE VERIFIED SECURE WEAPON | Soldiers clear their weapon and wait to be inspected by a lane safety. | |
| ONCE ALL FIRERS ARE VERIFIED GREEN, TOWER CONTINUES. | | | |
| CONDUCT OF THE RANGE | FIRERS SECURE YOUR DUNNAGE ONCE COMPLETE, PREPARE FOR CONTINUING OPERATIONS | Firers secure weapon, ammunition, and dunnage, then prepare for continuing operations. | |
| TOWER WAITS FOR ALL SOLDIERS TO REACH THE ENTRY CONTROL POINT PRIOR TO ADVANCING THE NEXT FIRING ORDER TO THE BASELINE. | | | |
| Legend: DODIC – Department of Defense identification code, N/A – not applicable | | | |

F-125. Upon the Soldiers completion of stage 2, day fire, CBRN, and collecting their dunnage from the firing position, a lane safety clears them. The RSO or lane safety verifies weapons cleared prior to the Soldier moving from the firing point. Once the Soldiers have cleared, the lane safety communicates the green WSS to the tower operator. The tower operator then issues an administrative command directing the Soldiers off the range.

STAGE 4 – NIGHT FIRE, CHEMICAL, BIOLOGICAL, RADIOLOGICAL, AND NUCLEAR

F-126. Stage 4, Night Fire, CBRN is a required event as part of automatic rifle qualification. The purpose of the stage 4 events to train and evaluate the firer's ability to engage targets while operating with individual chemical protective equipment. At a minimum, Soldiers are required to fire this course of fire while wearing individual combat equipment and a protective mask with hood. All Soldier's assigned an automatic rifle must complete this course of fire as part of their qualification based on their access to primary simulations systems (see table F-79.)

Table F-79. Stage 4, Day Fire, Chemical, Biological, Radiological, and Nuclear, training environment requirement

| <i>Supported / Available System</i> | <i>Authorized As</i> | <i>Qualification Environment Required</i> | |
|---|----------------------|---|-------------------------|
| | | <i>Virtual</i> | <i>Live (Live-Fire)</i> |
| Soldier and squad virtual training system (S / SVT) | Primary | X | |
| Engagement skills trainer (EST) | Alternate | X | |
| None available | Live-Fire | | X |

F-127. All firers who have access to an authorized primary or alternate simulation system are not authorized training ammunition to conduct this event in a live environment under live-fire conditions. Units that have secured resources may use the live-fire CBRN qualification for record.

F-128. Stage 4 is only for units that do not have access to an authorized simulator system based on the system's basis of issue plan. Failure to coordinate for the appropriate system or failure to conduct the CBRN qualification using a designated and authorized system does not authorize the use of training ammunition for this event.

AMMUNITION

F-129. To effectively plan and forecast for sufficient training ammunition, the unit uses the ammunition requirements listed in table F-80. Units need to identify the total number of firers. Units should plan for unscheduled firers and necessary retraining by increasing their forecasted training ammunition, as appropriate. Firers place ammunition in their ammunition pouches. Staging or pre-positioning ammunition is not authorized for the conduct of Table VI, CBRN, Night training.

Table F-80. Stage 4, Automatic Rifle, Table VI, Night Fire, Chemical, Biological, Radiological, and Nuclear ammunition requirements

| <i>Training Event</i> | <i>DODIC</i> | <i>Nomenclature</i> | <i>Quantity</i> | <i>Remarks</i> |
|--|--------------|---|-----------------|--|
| Qualification, Night Fire | AB73 | CTG, 5.56mm, 4 all, M855A1, 1 tracer, M856A1, EPR, linked | 50 | One three to five round killing burst is authorized for each target presented. |
| Legend: CTG – cartridge, DODIC – Department of Defense identification code, EPR – enhanced performance round, mm – millimeter | | | | |

SCENARIO ENGAGEMENTS

F-130. Targets are presented to the firer in single and multiple target arrays. Targets are presented such that 90-percent of the target is clearly visible to the firer from the expected or planned firing position. Targets are exposed to the firer based on the number of targets presented during the engagement as follows:

- Single target engagements are exposed for 8 seconds.
- Double target engagements are exposed for 12 seconds.
- Triple target engagements are exposed for 16 seconds.

F-131. There is a five-second delay at night between each engagement. Table F-81 shows the scenario engagement sequence for CBRN qualification. The leader annotates the official record of training on DA Form 7801.

Table F-81. Stage 4, Night Fire, Chemical, Biological, Radiological, and Nuclear target engagement sequence

| <i>Stage 4, Night Fire, CBRN, Standing, Unsupported</i> | | | |
|--|--------------------|---------------|----------------------|
| <i>Engagement</i> | <i>Target Type</i> | <i>Range</i> | <i>Exposure Time</i> |
| CBRN Night 1 | F-type | 50 m RIGHT | 8 sec |
| CBRN Night 2 | E-type | 50 m LEFT | 8 sec |
| CBRN Night 3 | E-type | 100 m | 8 sec |
| CBRN Night 4 | F-type | 50 m RIGHT | 12 sec |
| | E-type | 50 m LEFT | |
| CBRN Night 5 | E-type | 50 m LEFT | 12 sec |
| | E-type | 100 m | |
| CBRN Night 6 | F-type | 50 m RIGHT | 16 sec |
| | E-type | 50 m LEFT | |
| | E-type | 100 m | |
| Standing, Unsupported, Time per Firing Order Total | | | 89 sec |
| <p>Note: There is a 5-second delay between all engagements. These engagements are done <i>after</i> Stage 3, Table VI, Qualification, Night Fire engagements.</p> | | | |
| <p>Legend: CBRN – chemical, biological, radiological, and nuclear; m – meters; sec – seconds</p> | | | |

F-132. Table F-82 provides the Table VI, Qualification, CBRN throughput schedule. Units use Table VI, Qualification as a guide. The table portrays the overall efficiency of the range facility when conducting the training event. The table provides the overall throughput timetable, based on the time the unit requires to remove one firing order from the firing positions and move the next firing order forward.

Table F-82. Stage 4, Night Fire, Chemical, Biological, Radiological, and Nuclear, standing, unsupported

| Stage | Time to Execute | | | Remarks | |
|--|--|--------------|---------------|---|----------------|
| Stage 4, Night Fire, CBRN, Standing, Unsupported | 2:29 minute | | | Includes 1 minute transition to CBRN. | |
| Total Time Per Firing Order | 5:24 minute | | | Does not include administrative time to move firing order to or from their respective firing positions. | |
| Total Number of Firing Orders | Table VI Execution With Administration Time Between Firing Orders | | | Total Firer Throughput Based on Range Configuration | |
| | 2 min | 5 min | 10 min | 16 Lane | 32 Lane |
| 2 | 6 min | 12 min | 22 min | 32 | 64 |
| 3 | 10 min | 19 min | 34 min | 48 | 96 |
| 4 | 13 min | 25 min | 45 min | 64 | 128 |
| 5 | 16 min | 31 min | 56 min | 80 | 160 |
| 6 | 19 min | 37 min | 1 hr 7 min | 96 | 192 |
| 7 | 22 min | 43 min | 1 hr 18 min | 112 | 224 |
| 8 | 26 min | 50 min | 1 hr 30 min | 128 | 256 |
| 9 | 29 min | 56 min | 1 hr 41 min | 144 | 288 |
| 10 | 32 min | 1 hr 2 min | 1 hr 52 min | 160 | 320 |
| 11 | 35 min | 1 hr 8 min | 2 hrs 3 min | 176 | 352 |
| 12 | 38 min | 1 hr 14 min | 2 hrs 14 min | 192 | 384 |
| 13 | 42 min | 1 hr 21 min | 2 hrs 26 min | 208 | 416 |
| 14 | 45 min | 1 hr 27 min | 2 hrs 37 min | 224 | 448 |
| 15 | 48 min | 1 hr 33 min | 2 hrs 48 min | 240 | 480 |
| 16 | 51 min | 1 hr 39 min | 2 hrs 59 min | 256 | 512 |
| 17 | 54 min | 1 hr 45 min | 3 hrs 10 min | 272 | 544 |
| 18 | 58 min | 1 hr 52 min | 3 hrs 22 min | 288 | 576 |
| 19 | 1 hr 1 min | 1 hr 58 min | 3 hrs 33 min | 304 | 608 |
| 20 | 1 hr 4 min | 2 hrs 4 min | 3 hrs 44 min | 320 | 640 |
| Legend: CBRN – chemical, biological, radiological, and nuclear, hr – hour; hrs – hours, min – minutes | | | | | |

F-133. Three general movement schedules are available to assist firing order placements on the range, 2 minutes, 5 minutes, and 10 minutes. The more proficient a unit is at operating a small arms range facility, the greater the firer throughput on the facility. This schedule does not include time required for retraining, refire, or firers who have persistent problems using a reticle. See table F-79 for the throughput time schedule.

CONDUCT OF THE RANGE

F-134. Leaders instruct Soldiers on the objectives of Table VI, Qualification, CBRN and the importance of the functional elements of the shot process. Leaders conduct Table VI, Qualification, CBRN tasks in one scenario, containing single, double, and triple threat presentations. Firers must hit a minimum of 7 of the 10 targets presented (70-percent) to successfully pass.

F-135. Soldiers begin Table VI, Qualification, CBRN training by moving into the firing position following administrative commands from the tower operator. Soldiers enter the range and move to their firing points. Once at the firing point, firers assume a standing, unsupported firing position. Firers fire the tasks in Table VI, Qualification, CBRN from the ready throughout the duration of the course of fire. Table F-83 provides an example of the administrative commands for moving a new firing order into position.

Table F-83. Stage 4, Night Fire, Chemical, Biological, Radiological, and Nuclear, new firing order, conduct of the range example









| <i>New Firing Order, Conduct of the Range</i> | | | |
|---|-------------------|--|----------------|
|  CBRN | Engagement | Target | Target Type |
| | New Firing Order | N/A | N/A |
| | Rounds per Target | DODIC | Time (Seconds) |
| | N/A | AB73 | NO LIMIT |
| TOWER | | SOLDIER ACTION | |
| CONDUCT OF THE RANGE FIRERS, SECURE YOUR WEAPON AND AMMUNITION ONCE COMPLETE, MOVE TO YOUR FIRING POINT | | Soldiers secure their weapon, ammunition, and chemical protective mask and move to the designated firing point. | |
| ONCE FIRERS ARE SET AT THEIR FIRING POINT, THE TOWER CONTINUES. | | | |
| CONDUCT OF THE RANGE FIRERS, CHEMICAL AGENTS HAVE BEEN REPORTED IN YOUR AREA GAS GAS GAS | |  Soldiers don their protective equipment. | |
| ONCE ALL FIRERS HAVE COMPLETED DONNING PROTECTIVE GEAR, THE TOWER CONTINUES. | | | |
| Legend: CBRN – chemical, biological, radiological and nuclear; DODIC – Department of Defense identification code, N/A – not applicable | | | |

Table F-83. Stage 4, Night Fire, Chemical, Biological, Radiological, and Nuclear conduct of fire, example (continued)

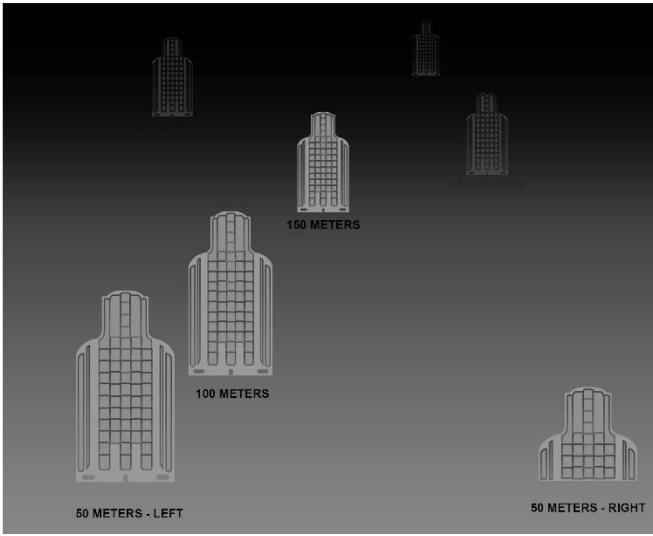
| <i>Stage 4, Night Fire, CBRN, Standing, Unsupported</i> | | | |
|---|--|--|-----------------------|
|  | Engagement | Target | Target Type |
| | 1 to 6 | E-1 F-1 | Point |
| | Rounds per Target | DODIC | Time (Seconds) |
| | 3 to 5 rounds 50-round belt | AB73 | 68 |
| TOWER | | SOLDIER ACTION | |
| WEAPONS SAFETY STATUS RED | FIRERS MAKE READY | Soldier assumes the standing unsupported firing position, loads one 50-round ammunition belt, ensures the weapon is on SAFE, and remains at the READY. | |
| ALERT | CONTACT |     | |
| TARGET DESCRIPTION | MULTIPLE TROOPS | | |
| DIRECTION | FRONT | | |
| RANGE | MID-RANGE | | |
| METHOD | NEAR TO FAR | | |
| CONTROL | WEAPONS FREE WEAPONS FREE | Soldier moves the weapon from SAFE to FIRE, and begins the target acquisition process. | |
| EXECUTION | ENGAGE WHEN POSITIVELY IDENTIFIED | Soldier acquires targets, prioritizes targets, and engages targets with one killing burst per target. | |
| ONCE ALL FIRERS ARE COMPLETE, TOWER CONTINUES. | | | |
| WEAPONS SAFETY STATUS REMAINS RED | | | |
| Note: There is a 3-second delay between all engagements. | | | |
| Legend: CBRN – chemical, biological, radiological, and nuclear, DODIC – Department of Defense identification code, | | | |

F-136. Upon the firers completion of stage 4, night fire, CBRN, and collecting their dunnage and ammunition, a lane safety clears them. A lane safety verifies the clearing prior to the Soldier moving from the firing point. Once the lane safety clears the Soldiers, the lane safety communicates the WSS to the tower operator and the tower operator issues an administrative command to move the completed Soldiers off the range. Table F-84 is an example of this command.

Table F-84. Stage 4, Night Fire, Chemical, Biological, Radiological, and Nuclear, completed firing order, conduct of the range example

| <i>Completed Firing Order, Conduct of the Range</i> | | | |
|--|--|--|-----------------------|
|  <p style="text-align: center;">CBRN</p> | Engagement | Target | Target Type |
| | Completed Firing Order | N/A | N/A |
| | Rounds per Target | DODIC | Time (Seconds) |
| | N/A | N/A | NO LIMIT |
| TOWER | SOLDIER ACTION | | |
| TOWER MUST ASSUME ALL FIRERS WEAPONS SAFETY STATUS IS RED | | | |
| TERMINATION | CEASE FIRE CEASE FIRE | Soldiers stop firing and place weapons on SAFE. | |
| WEAPONS SAFETY STATUS GREEN | GO GREEN GO GREEN | Soldiers clear their weapon and wait to be inspected by a lane safety. | |
| ONCE TOWER CONFIRMS ALL WEAPONS ARE GREEN AND CLEAR, TOWER CONTINUES | | | |
| CONDUCT OF THE RANGE | ALL CLEAR ALL CLEAR SECURE YOUR DUNNAGE MOVE TO THE ENTRY CONTROL POINT | Firers unmask, secure their weapon, ammunition, and dunnage. Once complete, they move to the range's entry control point. | |
| Tower waits for all Soldiers to reach the entry control point (ECP) prior to moving the next firing order into position. | | | |
| Legend: CBRN – chemical, biological, radiological, and nuclear, DODIC – Department of Defense identification code, N/A – not applicable | | | |

Appendix G

Sniper

This appendix describes the Army-standard events for training through qualification. All Soldiers assigned a sniper weapon system and serving in a sniper position according to the units' MTOE must qualify. Once completed successfully, Soldiers can progress to higher levels of marksmanship training or certification, and may use the weapon during any collective live-fire training events within the qualification period.

This appendix provides an overview of the training and qualification standards. It provides a snapshot to commanders of the Army's requirement to achieve and sustain a level of weapons proficiency for their Soldiers assigned a sniper rifle. Soldiers assigned multiple weapons and executing the sniper rifle training strategy must also be qualified on their primary assigned individual weapon and equipment within the past qualification period based on the commanders MAL.

SNIPER RIFLE TRAINING STRATEGY

G-1. The standard IWTS lists six tables of training events. The events, with all associated resources required; ranges, simulators, simulations, ammunition, and time, are explained in each table. This appendix has a section for each training event within the weapon's strategy. Companies executing the training events apply the eight-step training model, as appropriate.

G-2. Table G-1 shows the sniper rifle training strategy through qualification. The table provides the sequence of training events, the days required, and the training time remaining to achieve live-fire proficiency.

Table G-1. Individual weapons training strategy structure

| <i>Sniper</i> | <i>Table I, PMI&E</i> | <i>Table II, PLFS</i> | <i>Table III, Drills</i> | <i>Table IV, Basic</i> | <i>Table V, Practice</i> | <i>Table VI, QUAL</i> |
|--|-------------------------------|---------------------------|------------------------------|----------------------------|------------------------------|---------------------------|
| | <i>PRQ</i> | <i>PRQ</i> | <i>PRQ</i> | <i>REQUIRED</i> | | <i>REQUIRED</i> |
| Days Required | 0.5 | 1.0 | 0.5 | 1.0 | 1.0 | 1.0 |
| <p>Legend: PLFS – preliminary live-fire simulation, PMI&E – preliminary marksmanship instruction and evaluation, PRQ – prerequisite, QUAL – qualification</p> | | | | | | |

AMMUNITION

G-3. The ammunition required for the sniper rifle training strategy through qualification is shown in table G-2 on page G-2. The table includes the associated weapons by LIN and NSN, all training munitions including DDI requirements, and the live-fire training ammunition requirements.

G-4. The numbers replicate what each firer is authorized to complete one complete iteration of each event in the training strategy through qualification. The munitions listed below do not include any retraining, cross-training, demonstration munitions, or collective training requirements.

Table G-2. Sniper rifle individual weapon training strategy ammunition requirements

| <i>DODIC</i> | <i>Munition Type</i> | <i>Table III, Drills</i> | <i>Table IV, Basic</i> | <i>Table V, Practice</i> | <i>Table VI, QUAL</i> | <i>Total</i> |
|---|---|------------------------------|----------------------------|------------------------------|---------------------------|--------------|
| M110 | | | | | | |
| AA11 | CTG, 7.62mm special ball, M118 LR | | 91 | 42 | 42 | 175 |
| M2010 | | | | | | |
| A191 | CTG, .300 win mag match grade, MK 248 MOD 0 | | 71 | 42 | 42 | 155 |
| M107 | | | | | | |
| A552 | CTG, .50 cal. ball, M2/M33 | | 71 | 42 | 42 | 155 |
| <i>Model</i> | <i>LIN / NSN</i> | | <i>Model</i> | <i>LIN / NSN</i> | | |
| M107 | R45351 / 1005-01-469-2133 | | M2010 | R05009 / 1005-01- 588-2913 | | |
| M110 | R45601 / 1005-01-534-2841 | | | | | |
| <p>Note. Each member of the team will qualify and sustain one primary weapon, the M110, M2010 or M107. Units that do not have thermal optics for their weapons are required to coordinate for them. The AN/PAS-13v2 is required to complete the live-fire events in the training strategy.</p> | | | | | | |
| <p>Legend: cal – caliber, CTG – cartridge, DODIC – Department of Defense identification code, LIN – line item number, LR – long range, mm – millimeter, NSN – national stock number, QUAL – qualification course of fire</p> | | | | | | |

SNIPER RIFLE, TABLE I, PRELIMINARY MARKSMANSHIP INSTRUCTION AND EVALUATION

G-5. The PMI&E event is a live-fire prerequisite that Soldiers must complete prior to executing any live-fire event for the sniper rifle. Sniper Rifle, Table I, PMI&E, lists tasks that are critical to the safety of the firer, essential to the operation of the weapon assigned, or key to the effective employment of the weapon system. The tasks listed in the table tasks test the Soldier's ability to accomplish these critical tasks correctly, effectively, and efficiently. Leaders conduct all tasks in a garrison environment prior to the live-fire weapons training density.

TASK, CONDITIONS, AND STANDARD

G-6. Units are encouraged to conduct preparatory training prior to Table I training (for example, hip pocket training, STT) to maximize available resources. Units will develop a written test evaluating the functional aspects of the weapon, ammunition, and critical skills articulated in TC 3-22.10. Soldiers must successfully complete Sniper Rifle, Table I, PMI&E tasks within the training window T-6 though T-week for both active Army and Reserves. (See table G-3.)

Note. Refer to TC 3-20.0 for more information on the training timelines for all live-fire prerequisites. Weapon specific and tactical employment information regarding sniper rifle is in TC 3-22.10.

G-7. Leaders provide instruction and evaluation on the standard PMI&E topics described in TC 3-22.10 to Soldiers assigned a sniper weapon system. Units may add topics to their Table I requirements, as needed. Table G-3 shows the task, conditions, and standards for the event.

Table G-3. Sniper Rifle, Table I, Preliminary Marksmanship Instruction and Evaluation

| | |
|---|---|
| Task: | Demonstrate proficiency on the functional aspects of the weapon, optics, thermals, ammunition, and critical skills necessary to correctly and safely employ the sniper weapon system. |
| Conditions: | <p>In a garrison environment, given a sniper rifle as assigned on the master authorization list for the unit.</p> <p>Provided the correct reference to conduct training:</p> <ul style="list-style-type: none"> • TC 3-22.10. • TM 9-1005-438-13&P. • TM 9-1005-342-10. • TM 9-1005-239-10. |
| Standard: | The Soldier must pass PMI&E successfully between T-6 and T-week prior to firing any live ammunition by receiving all GOs on demonstrated performance and achieving a passing score of 80 percent or higher on a written test. |
| Legend: PMI&E – preliminary marksmanship instruction and evaluation, TC – training circular, TM – technical manual | |

G-8. Table G-4 shows the training event design template for Sniper Rifle, Table I, PMI&E. Units use the training event design templates to assist in the proper synchronization when developing their UTP.

Table G-4. Training event design template for Sniper Rifle, Table I

| <i>Sniper Rifle, Table I, PMI&E</i> | | | | | | |
|--|--------------------|---------------------------|-------------------------|---------------------------------------|--------------------------|------------------------------|
| EVENT NAME: | PMI&E | ENVIRONMENT: | LIVE | 0.5 | | |
| WEAPON: | M107/ M110/ M2010 | CONDITIONS: | HANDS ON | | | |
| CATEGORY: | PREREQUISITE | PRIMARY FACILITY: | GARRISON | DAYS REQUIRED | | |
| PUBLICATION: | TC 3-22.10 | ALTERNATE FACILITY: | CLASS | | | |
| REQUIRED: | YES | COMPONENT: | AC | RC | 60 SOLDIERS | |
| EVALUATION: | SNIPER TEAM LEADER | FREQUENCY: | 2 | 1 | | |
| VALID FOR: | T+6 | ANNUAL DAYS TOTAL: | 1 | 0.5 | THROUGHPUT | |
| TABLE | | | | | | |
| | I | II | III | IV | V | VI |
| | PMI&E | PLFS | DRILLS | BASIC | PRACTICE | QUAL |
| | REQUIRED | | | | | 4.0 |
| WHEN EXECUTED: | T-6 through T-X | | | | | TNG DAYS TO QUAL |
| CONDEMNATION CRITERIA (CC) | RULE 1 | RULE 2 | RULE 3 | RULE 4 | RULE 5 | RULE 6 |
| | TIME | KEY LEADER TURNOVER | COMMANDER ASSESSMENT | SUBORDINATE ELEMENT PROFICIENCY | SPECIALTY PROFICIENCY | STAFF SECTION PROFICIENCY |
| Remarks: Each Soldier assigned a sniper weapon system must successfully complete Table I, PMI&E, between T-6 and T-X, <i>prior to any live-fire event with the weapon.</i> | | | | | | |
| Note: Table I <i>should</i> be completed prior to any other table to ensure the Soldier understands the proper functioning and immediate action for the weapon. | | | | | | |
| Legend: AC – active component (known as active duty), CLASS - classroom, EVAL – evaluation, PLFS – preliminary live-fire simulation, PMI&E – preliminary marksmanship instruction and evaluation, QUAL – qualification, RC – Reserve Component (known as Reserves), STT – sergeant’s time training, TC – training circular, T+6 – training week or month plus six, T-X – training event exercise, TNG DAYS TO QUAL – number of training days remaining on the critical path to weapon’s qualification | | | | | | |

TRAINING PLAN

G-9. Table G-5 shows the Sniper Rifle, Table I, PMI&E training plan’s tasks. The Soldier demonstrates proficiency on these tasks to receive credit. Leaders and trainers must be proficient on these tasks prior to conducting training and testing.

Table G-5. Sniper Rifle, Table I, Preliminary Marksmanship Instruction and Evaluation training plan

| Reference | Topic or Task |
|---|--|
| TC 3-22.10 | Ammunition identification |
| TC 3-22.10 | Rules of fire arms safety |
| TC 3-22.10 | Weapons safety status |
| TC 3-22.10 | Weapons control status |
| TC 3-20.31-4 | Conduct of fire (fire commands) |
| 071-028-0035 | Perform operator preventive maintenance checks and services (PMCS) on a sniper weapon system (SWS) |
| 071-028-0020 | Perform a function check on the M107 long range sniper rifle |
| 071-028-0013 | Perform a function check on the M110 semiautomatic sniper system |
| 071-028-0030 | Perform a function check on an M2010 sniper rifle |
| 071-028-0025 | Mount the daylight scope on the M107 long range sniper rifle (LRSR) |
| 071-028-0017 | Mount the day optic sight to an M110 semiautomatic sniper system (SASS) |
| 071-028-0033 | Mount the day optical sight to an M2010 sniper rifle |
| 071-028-0024 | Zero an M107 long range sniper rifle |
| 071-028-0018 | Zero an M110 semiautomatic sniper system |
| 071-028-0034 | Zero an M2010 sniper rifle |
| Note: ALL Soldiers assigned a sniper rifle will conduct PMI&E. Leaders must include the appropriate mount, boresight / align, zero, and dismounting procedures for any assigned equipment. | |
| Legend: COM – common; TC – training circular | |

SNIPER RIFLE, TABLE II, PRELIMINARY LIVE-FIRE SIMULATIONS

G-10. Leaders use Table II, PLFS to evaluate the Soldier’s ability to engage single and multiple stationary targets from multiple, stationary, supported and unsupported firing positions, during day and limited visibility, and during CBRN conditions in a simulated combat environment. Soldiers are required to complete the simulations training plan successfully prior to executing the Table II simulated qualification course of fire. The tasks in Table II (table G-6 on page G-6) are live-fire prerequisites that Soldiers complete prior to any event using live ammunition (Tables IV, V, and VI, for example).

TASK, CONDITIONS, AND STANDARD

G-11. Units must use the approved primary or alternate simulations to execute Table II for record between T-6 and T-week for the upcoming weapons training density. Units must maintain the Soldiers' training records for 12 months. When conducting live-fire events, units must have the Soldier's Table II training records readily available on the range facility.

Table G-6. Sniper Rifle, Table II, Preliminary-Live-Fire Simulations

| | |
|--------------------|--|
| Task: | Demonstrate proficiency on the functional aspects of the weapon, ammunition, and critical skills necessary to correctly use the sniper rifle with associated equipment. |
| Conditions: | Given the following: <ul style="list-style-type: none"> • Fully mission capable weapon and equipment as assigned on the master authorization list for the unit. • Full combat uniform, issued equipment, and protective mask. • An authorized simulations device with standard training model and Sniper Rifle, Table II, Gate to Live Fire (GTLF) event. |
| Standard: | The Soldier must successfully complete the grouping and zeroing, known distance, practice, GTLF, chemical, biological, radiological, and nuclear, and unassisted night fire events with all assigned attachments between T-6 and T-week prior to firing any live ammunition. |

G-12. Table G-7 shows the general training information for planning purposes for the Sniper Rifle, Table II. The training event design template provides key training information to develop the UTP for their Soldiers.

Table G-7. Training event design template for Sniper Rifle, Table II, Preliminary-Live-Fire Simulations

| <i>Sniper Rifle, Table II, PLFS</i> | | | | | | |
|---|-----------------------|---------------------------|-------------------------|---------------------------------------|--------------------------|---------------------------------|
| EVENT NAME: | PLFS | ENVIRONMENT: | | VIRTUAL | 1.0 | |
| WEAPON: | M107/ M110/ M2010 | CONDITIONS: | | TADSS | | |
| CATEGORY: | PREREQUISITE | PRIMARY FACILITY: | | S/SVT | DAYS REQUIRED | |
| PUBLICATION: | TC 3-22.10 | ALTERNATE FACILITY: | | DRY | | |
| REQUIRED: | YES | COMPONENT: | AC | RC | 60 SOLDIERS | |
| EXTERNAL EVAL: | SNIPER TEAM LEADER | FREQUENCY: | 2 | 1 | | |
| VALID FOR: | T+6 | ANNUAL DAYS TOTAL: | 1 | 0.5 | THROUGHPUT | |
| TABLE | | | | | | |
| | I | II | III | IV | V | VI |
| | PMI&E | PLFS | DRILLS | BASIC | PRACTICE | QUAL |
| | | REQUIRED | | | | 3.5 |
| WHEN EXECUTED: | T-6 through T-X | | | | | TNG DAYS TO QUAL |
| CONDEMNATION CRITERIA (CC) | RULE 1 | RULE 2 | RULE 3 | RULE 4 | RULE 5 | RULE 6 |
| | TIME | KEY LEADER TURNOVER | COMMANDER ASSESSMENT | SUBORDINATE ELEMENT PROFICIENCY | SPECIALTY PROFICIENCY | STAFF SECTION PROFICIENCY |
| Remarks: Each Soldier assigned an individual weapon must successfully complete Table II, PLFS training, between T-6 and T-X, prior to any live-fire event with the weapon. | | | | | | |
| Legend: AC – active component (known as active duty), DRY – dry fire, EVAL – evaluation, PLFS – preliminary live-fire simulation, PMI&E – preliminary marksmanship instruction and evaluation, QUAL – qualification, RC – Reserve Component (known as Reserves), S/SVT – soldier and squad virtual trainer, T+6 – training week or month plus six, TADSS – training aids, devices, simulators, and simulations, TC – training circular, T-X – training event exercise, TNG DAYS TO QUAL – number of training days remaining on the critical path to weapon's qualification | | | | | | |

SIMULATIONS

G-13. Each Soldier is authorized simulations usage for weapons training and sustainment based on their component. The authorized hours of training are cumulative annually to enable completing all required training prior to the execution of Table II elements. Table G-8 shows the annual hours authorized per Soldier by component:

Table G-8. Simulations authorizations table

| <i>Simulation Time Authorizations (hours)</i> | |
|---|-----------------|
| <i>Active Army</i> | <i>Reserves</i> |
| 12.0 | 6.0 |

G-14. Table G-9 lists primary and alternate simulations systems. Primary systems are the preferred method to deliver the appropriate training program to the Soldier. Alternate systems provide the minimum form, fit, and function capabilities to build the firer’s skill and experience on basic tasks. The unit determines how to use the simulations hours authorized per Soldier within the fiscal year.

Table G-9. Sniper Rifle, Table II, primary and alternate authorized systems

| <i>System</i> | <i>Primary</i> | <i>Alternate</i> | <i>Remarks</i> |
|---|----------------|------------------|---|
| Soldier and squad virtual trainer (S / SVT) | X | | |
| Dry-fire engagement drills | | X | Serves as a primary training device until S/SVT suite availability and accessibility are established Army-wide. |
| | | | Commanders should review dry-fire drill tasks and effectiveness prior to execution. |

Note. For any other device or system not listed, the unit should contact the Maneuver Center of Excellence for possible system evaluation or if an approved training plan is available. When authorized systems are available for training, units are not authorized to develop training plans on systems not specifically authorized.

Individual weapons virtual simulation systems can support no more than five sniper weapon system firers per suite at a time. The standard simulations bay is composed of two suites, allowing for 10 firers to train in a firing order. The unit should develop a rotational plan to accommodate the total number of Soldiers training.

TRAINING PLAN

G-15. Soldiers train on their weapon within the simulation system’s training plan. For simulation systems without an integrated training plan, operators must select the appropriate scenarios based on the system’s IUH.

G-16. The simulations sniper rifle training plan culminates in the system’s GTLF. Units may elect to train additional advanced tactical engagement scenarios, but must conduct grouping and zeroing, practice, and the gate to live fire exercises at a minimum, as listed in table G-10.

Table G-10. Sniper rifle simulations training plan

| Aiming Device | Task | Exercise Name | Required GTLF |
|--|-----------|--------------------------------|---------------|
| Iron Sights | 1 | Grouping, Zeroing, Truing | REQ |
| | 2 | Table V, Practice | REQ |
| | 3 | Table VI, Qualification | GTLF |
| | 4 | Movers | OPT |
| | 5 | Hold-Offs | OPT |
| Day Optics | 6 | Grouping, Zeroing, Truing | REQ |
| | 7 | Table V, Practice | REQ |
| | 8 | Table VI, Qualification | GTLF |
| | 9 | Movers | OPT |
| | 10 | Hold-Offs | OPT |
| Night Optics | 11 | Grouping, Zeroing, Truing | REQ |
| | 12 | Table V, Practice | REQ |
| | 13 | Table VI, Qualification | GTLF |
| | 14 | Movers | OPT |
| | 15 | Hold-Offs | OPT |
| <p>Note: When thermal optics are not integrated into the approved simulations system, units should conduct dry exercises for concurrent training on Table V and Table VI with thermal optics.</p> <p>The M2010 sniper rifle does not have iron sights and will not be required to train tasks 1 through 5.</p> <p>Legend: GTLF – gate to live fire; OPT – optional; REQ – required</p> | | | |

SNIPER RIFLE, TABLE III, DRILLS

G-17. Table III, Drills, is a series of physical actions (drills) that the Soldier completes with their assigned weapon and equipment in a repetitious manner to demonstrate proficiency in weapons handling and movement. Soldiers must complete the drills in this table successfully prior to any live-fire event, including grouping procedures.

TASK, CONDITIONS, AND STANDARD

G-18. Leaders conduct the drills in Table III in a round-robin manner where the primary trainer is the team leader, squad leader, or assigned NCO. Table III's task, conditions, and standards is shown in table G-11.

Table G-11. Sniper Rifle, Table III, Drills, task, conditions, and standard

| | |
|--------------------|--|
| Task: | Demonstrate proficiency on the functional aspects of the weapon, ammunition, and critical skills necessary to correctly use the sniper weapon system with assigned equipment and attachments. |
| Conditions: | Given the following: <ul style="list-style-type: none"> • Fully mission capable, weapon and equipment as assigned on the master authorization list for the unit. • Checklist of required actions and time standards found in Training Circular 3-22.10 and associated individual task reports described in this section. |
| Standard: | The Soldier successfully demonstrates proficiency by passing weapons handling, manipulation, and movement tasks listed in the training plan between T-6 and T-week prior to firing any live ammunition. |

G-19. Table G-12 shows the general training information for planning purposes for Sniper Rifle, Table III. The training event design template provides key training information to develop the UTP for their Soldiers.

Table G-12. Training event design template for Sniper Rifle, Table III, Drills

| <i>Sniper Rifle, Table III, Drills</i> | | | | | | | |
|--|------------------------|---------------------------|-------------------------|---------------------------------------|--------------------------|---------------------------------|--|
| EVENT NAME: | DRILLS | ENVIRONMENT: | | LIVE | 0.5 | | |
| WEAPON: | M107 / M110 / M2010 | CONDITIONS: | | HANDS ON | | | |
| CATEGORY: | PREREQUISITE | PRIMARY FACILITY: | | GARRISON | DAYS REQUIRED | | |
| PUBLICATION: | TC 3-22.10 | ALTERNATE FACILITY: | | TA | | | |
| REQUIRED: | YES | COMPONENT: | AC | RC | 60 SOLDIERS | | |
| EXTERNAL EVAL: | SNIPER TEAM LEADER | FREQUENCY: | 2 | 1 | | | |
| VALID FOR: | T+6 | ANNUAL DAYS TOTAL: | 1 | 0.5 | THROUGHPUT | | |
| TABLE | | | | | | | |
| I | | II | | III | | VI | |
| PMI&E | | PLFS | | DRILLS | | QUAL | |
| | | | | REQUIRED | | 3.0 | |
| WHEN EXECUTED: | T-6 through T-X or T-X | | | | | TNG DAYS TO QUAL | |
| CONDEMNATION CRITERIA (CC) | RULE 1 | RULE 2 | RULE 3 | RULE 4 | RULE 5 | RULE 6 | |
| | TIME | KEY LEADER TURNOVER | COMMANDER ASSESSMENT | SUBORDINATE ELEMENT PROFICIENCY | SPECIALTY PROFICIENCY | STAFF SECTION PROFICIENCY | |
| Remarks: Each Soldier assigned a sniper weapon system must successfully complete Table III, between T-6 and T-X, <i>prior to any live-fire event with the weapon</i> . Table III should be used as concurrent training on Tables IV, V, and VI while Soldiers are awaiting training in a firing order or between day and night phases. | | | | | | | |
| Legend: AC – active component (known as active duty), EVAL – evaluation, PLFS – preliminary live-fire simulation, PMI&E – preliminary marksmanship instruction and evaluation, QUAL – qualification, RC – Reserve Component (known as Reserves), TA – training area, TC – training circular, T+6 – training week or month plus six, TA – training area, T-X – training event exercise, TNG DAYS TO QUAL – number of training days remaining on the critical path to weapon's qualification, | | | | | | | |

TRAINING PLAN

G-20. Table G-13, on page G-12, lists the individual tasks for each of these drills. The individual task reports for these drills are in a shared folder on AKO. The hyperlink to this folder is in the reference section at the back of this training circular.

Table G-13. Sniper Rifle, Table III, Drills individual training plan

| Task | Task Name |
|--|--|
| 1 | Precombat checks |
| 2 | Load and conduct status check |
| 3 | Carry positions |
| 4 | Fight down |
| 5 | Fight up |
| 6 | Prone ready |
| 7* | Transition from primary weapon to secondary weapon |
| 8 | Reload |
| 9 | Clear malfunction |
| 10 | Unload / show clear |
| <p>Note. Where the individual task reports are not available on the Army Training Network, the individual task reports for these drills are in a shared folder on Army Knowledge Online. The hyperlink to this folder is in the reference section at the back of this publication.</p> <p>* This drill is only for Soldiers assigned multiple individual weapons or Soldiers assigned an individual weapon with a special purpose weapon.</p> | |

G-21. Units may add to the drills listed in table G-13, but may not remove any from Table III. Units developing additional drills are encouraged to provide the details of the drill, evaluation process, and timing considerations to the proponent of this publication for possible inclusion into future updates.

SNIPER RIFLE, TABLE IV, BASIC (ZEROING AND CONFIRMATION)

G-22. Sniper Rifle, Table IV, Basic (Zeroing and Confirmation) is conducted with live ammunition on an approved range facility. The purpose of Table IV training is to evaluate the firers' ability to zero all MAL assigned equipment, optics, thermals, pointers and illuminators, and confirm zero at a known distance. This table is conducted only after successful completion of the live-fire prerequisite tables (Tables I, II, and III). During home station training, snipers must complete Table IV prior to progressing to any other training event. Leaders conduct Table IV tasks on an automated SFF, HSR, or other approved facility.

TASK, CONDITIONS, AND STANDARD

G-23. Firers conduct Table IV tasks from the prone, supported firing position, 100 meters from the targets outlined in this chapter. Table IV tasks reinforce and build upon the skills Soldiers learned in the previous training events. Table G-14 provides the task, conditions, and standards for Table IV training.

Table G-14. Sniper Rifle, Table IV, Basic

| | |
|--|--|
| Task: | Conduct zeroing and confirmation of zero at distance, using slow-fire engagement procedures with the sniper weapon system and all aiming devices. |
| Conditions: | <p>Given the following:</p> <ul style="list-style-type: none"> • Fully mission capable weapon, ammunition pouches, and magazines. • Authorized range facility, full-caliber ammunition, and approved targetry. • Assigned primary optic, thermal optic, and pointer, illuminator, laser device. • Unit selected method of zeroing (as described in TC 3-22.10). <p>Note. Units that do not have organic thermal weapon sights for the M110 or M2010 must coordinate within their brigade for the appropriate thermal optic.</p> |
| Standard: | <p>Zeroing – Successfully place four of five-rounds in two consecutive shot groups within the 2 MOA circle (M110 and M2010) or 3 MOA (M107) surrounding the appropriate point of impact on the A8 zero target at 100-meters.</p> <p>Confirmation at Distance – after completion of the 100 meter zero the Soldier must successfully hit a properly presented E-type target at 500 meters with a minimum of four of five (80-percent) shots.</p> |
| Legend: MOA – minute of angle, TC – training circular | |

G-24. Table G-15, on page G-14, shows the training event design template for the Table IV, Basic. Leaders conduct this event on an authorized live-fire facility, typically an automated SFF, HSR, or other approved facility. See TC 25-8 for additional information on authorized range facilities.

Table G-15. Training event design template for Sniper Rifle, Table IV, Basic

| <i>Sniper Rifle, Table IV, Basic</i> | | | | | | |
|--|---------------------|---------------------------|-------------------------|---------------------------------------|--------------------------|---------------------------------|
| EVENT NAME: | BASIC | ENVIRONMENT: | | LIVE | 1.0 | |
| WEAPON: | M107 / M110 / M2010 | CONDITIONS: | | LIVE FIRE | | |
| CATEGORY: | REQUIRED | PRIMARY FACILITY: | | SFF HSR | DAYS REQUIRED | |
| PUBLICATION: | TC 3-22.10 | ALTERNATE FACILITY: | | MPMG | | |
| REQUIRED: | YES | COMPONENT: | AC | RC | 60 SOLDIERS | |
| EXTERNAL EVAL: | SNIPER TEAM LEADER | FREQUENCY: | 2 | 1 | | |
| VALID FOR: | T-X | ANNUAL DAYS TOTAL: | 2 | 1 | THROUGHPUT | |
| | TABLE | | | | | |
| | I | II | III | IV | V | VI |
| | PMI&E | PLFS | DRILLS | BASIC | PRACTICE | QUAL |
| | PRQ | PRQ | PRQ | REQUIRED | | 2.0 |
| WHEN EXECUTED: | | | | T-X | | TNG DAYS TO QUAL |
| CONDEMNATION CRITERIA (CC) | RULE 1 | RULE 2 | RULE 3 | RULE 4 | RULE 5 | RULE 6 |
| | TIME | KEY LEADER TURNOVER | COMMANDER ASSESSMENT | SUBORDINATE ELEMENT PROFICIENCY | SPECIALTY PROFICIENCY | STAFF SECTION PROFICIENCY |
| Remarks: Each Soldier assigned an individual weapon must successfully complete Table IV, Basic. | | | | | | |
| Legend: AC – active component (known as active duty), EVAL – evaluation, HSR – heavy sniper range, MPMG – multipurpose machine gun range, PLFS – preliminary live-fire simulation, PMI&E – preliminary marksmanship instruction and evaluation, PRQ – prerequisite, QUAL – qualification, RC – Reserve Component (known as Reserves), SFF – automated sniper field fire range, TC – training circular, T-X – training event exercise, TNG DAYS TO QUAL – number of training days remaining on the critical path to weapon’s qualification | | | | | | |

AMMUNITION

G-25. All Soldiers assigned a sniper rifle on a unit MAL must complete Sniper Rifle, Table IV tasks prior to advancing to Table V or Table VI. Leaders conduct Sniper Rifle, Table IV tasks to demonstrate the sniper’s ability to place well-aimed shots at or near the intended point of impact of a target consistently.

G-26. Firers conduct Table IV tasks using the aiming device assigned to them. Firers zero all assigned aiming devices and conduct confirmation at distance with their day and night optics.

G-27. To effectively plan and forecast for sufficient training ammunition, the unit should refer to the ammunition requirements listed in table G-16. Units need to identify the total number of snipers by sniper weapon system caliber and should plan for unscheduled firers and necessary retraining by increasing their forecasted training ammunition appropriately.

Table G-16. Table IV, Basic, ammunition authorizations

| | <i>M110</i> | <i>M2010</i> | <i>M107</i> | |
|--|-------------|--------------|-------------|--|
| <i>Function / Capability</i> | <i>AA11</i> | <i>A191</i> | <i>A552</i> | <i>Remarks</i> |
| Cold bore | 1 | 1 | 1 | Fired prior to conducting zeroing procedures. |
| Chronograph and grouping | 10 | 10 | 10 | NSN 1005-01-645-8136 |
| Zeroing, primary optic | 10 | 10 | 10 | |
| Zeroing, iron / BUIS | 10 | | 10 | <i>M2010 does not have an associated iron or BUIS.</i> |
| Zeroing, thermal | 10 | 10 | 10 | |
| Zeroing, pointer, illuminator, laser | 10 | 10 | | <i>M107 does not have an AN/PSQ-23A, STORM</i> |
| Confirmation at distance, primary optic | 10 | 10 | 10 | |
| Confirmation at distance, iron / BUIS | 10 | | 10 | <i>M2010 does not have an associated iron or BUIS.</i> |
| Confirmation at distance, thermal | 10 | 10 | 10 | |
| Confirmation at distance, pointer, illuminator, laser | 10 | 10 | | <i>M107 does not have an AN/PSQ-23A, STORM</i> |
| Total: | 91 | 71 | 71 | |
| <p>Notes.</p> <p>* - M110 and M107 firers must zero and confirm at distance both their BUIS and primary optic.</p> <p>Units without thermal optics must coordinate within their BCT for an appropriate AN/PAS-13v2 or similar sensor with the appropriate reticles for use during Table IV through VI.</p> <p>Snipers will only execute Table IV with their assigned sniper weapon. Any familiarization with the other weapons will not include zeroing or confirmation at distance.</p> <p>Legend: BCT – brigade combat team, BUIS – backup iron sight, NSN – national stock number</p> | | | | |

RANGE FACILITIES

G-28. Table G-17 shows the Army-standard range facilities designed to support Sniper Rifle, Table IV, Basic. Units reference their installation's range operations SOPs or local training regulation to identify the weapon-specific range facilities on the supporting installation. Units use their RFMSS system for all scheduling.

Table G-17. Sniper Rifle Table IV, Basic authorized range facilities and targetry

| <i>Table IV Exercise</i> | <i>Range Facility</i> | | | | |
|------------------------------|-----------------------|------------|-------------|------------|-------------|
| | <i>SFF</i> | <i>HSD</i> | <i>MPMG</i> | <i>QTR</i> | <i>MPRC</i> |
| M110 | P | | A | A | A |
| M2010 | P | | A | A | A |
| M107 | | P | A | A | A |

Legend: A – alternate facility, HSD – heavy sniper range, m – meter, MPMG – multipurpose machine gun range, MPRC – multipurpose range complex (or similar maneuver range), P – primary facility, SFF- sniper field fire range, QTR – qualification training range

TARGETRY AND INSTRUMENTATION

G-29. Table IV, Basic training requires a minimum of three targets per firer, placed on a target frame as shown on figure G-1. The targets are placed on a frame with backer board at the 100-meter line. This is a static target presentation and does not use the automated targets on the primary range facility (known as ARF). During the preparation phase, leaders should be familiar with the targetry used, the target frames and their proper emplacement, and the firing sequence of the engagements. Figure G-2, on page G-18, shows the primary targets and their proper positioning on the primary range facility.



| Table IV Exercise | Targetry | |
|---|--|--|
| <p>Zeroing 100 meters</p> | <p>A-8, target zero M4- / M16-series Weapons 25-meter zero. Short range and pistol marksmanship target.</p> <p>8 ½" x 11"</p> <p>NSN 6920-01-660-9191</p> |  |
| <p>Confirmation at Distance</p> | <p>E-1, target, silhouette: plastic, polyethylene, kneeling</p> <p>NSN 6920-00-071-4780</p> |  |
| | <p>D-1, target, 3-dimensional: plastic, mannequin, kneeling</p> <p>NSN 6920-01-164-9625</p> |  |
| | <p>B-8, target, bull's-eye paper, rifle long range, national match rifle (NMR), MR-1</p> <p>72" x 73"</p> <p>NSN: 6920-01-100-5062</p> |  |
| <p>Legend: " – inch, NSN – national stock number</p> | | |

Figure G-1. Sniper Rifle, Table IV, target requirements example

G-30. Units must have the instruments listed in table G-18 available for each firing sniper team on the facility. The firing unit and not the range facility typically provide this equipment.

Table G-18. Sniper required ballistic instruments

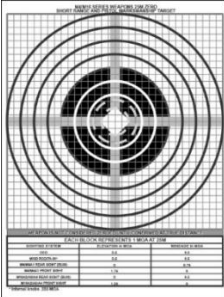
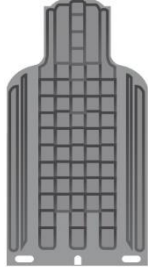
| <i>Instrument or Device</i> | <i>NSN</i> | <i>Quantity</i> |
|--|------------------|-----------------|
| Chronograph, firing | 1005-01-645-8136 | 1 per team |
| Ballistic computer | 6660-01-656-4810 | 1 per team |
| Time measuring, shot clock, counter | 6645-01-644-2563 | 1 each |
| Legend: NSN – national stock number | | |

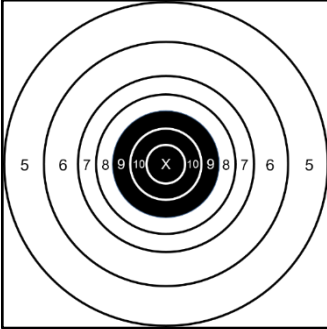
G-31. Figure G-2 shows an example of the target placement for conducting the chronograph group and zeroing procedures. See figure G-3 for the confirmation at distance target.

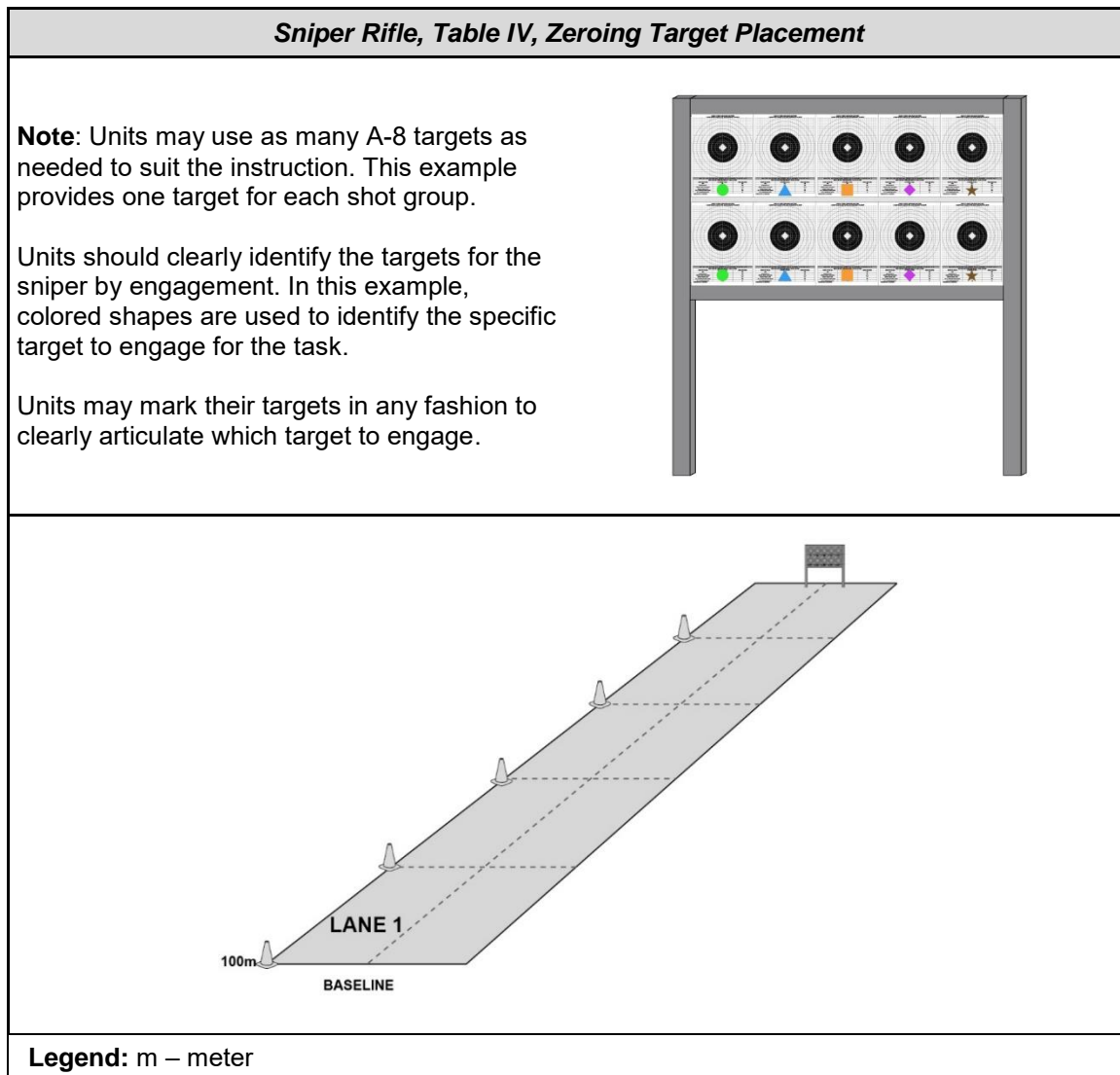

Figure G-2. Sniper Rifle, Table IV target requirements example

| Sniper Rifle, Table IV, Confirmation at Distance Target Placement | |
|--|---|
| <p>An E-type silhouette is placed at 500 meters from the firing position.</p> <p>The primary method for confirmation at distance requires the target to have instruments with a calibrated location of miss and hit (LOMAH) set. If the LOMAH is portable, the target frame is used.</p> <p>Units can add a contrasting point of aim (POA) scaled to the appropriate minute of angle on the E-type silhouette.</p> <p>Units must ensure the LOMAH system is calibrated to provide +/- 10mm accuracy based on the center POA indicated.</p> |  <p>SIT emplacement with LOMAH</p> |
| <p>Alternate method without LOMAH instrumentation uses a B-8 target on a locally fabricated target frame at 500 meters.</p> |  |
| <p>Legend: mm – millimeter, SIT – stationary Infantry target</p> | |

Figure G-3. Sniper Rifle, Table IV, target requirements example

CONDUCT OF THE RANGE

G-32. Leaders instruct Soldiers on the objectives of grouping and the importance of the functional elements of the shot process (see TC 3-22.10). Soldiers conduct the tasks in Table IV using up to eight separate engagements at targets 100-meters from the firing point, with a zero confirmation target at 500-meters. Firers use one A-8 target for each five-round group. Snipers complete the engagements in the sequence shown in table G-19.

Table G-19. Sniper Rifle, Table IV, firing sequence example

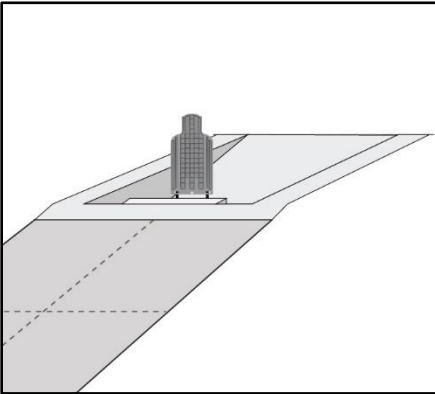
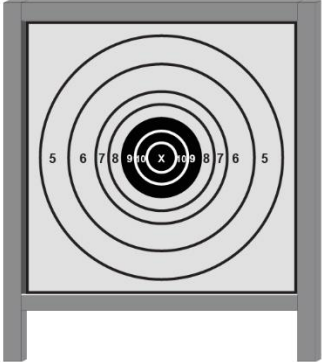
| <i>ENG</i> | <i>Task</i> | <i>Shot Group</i> | <i>Target</i> | <i>TGT</i> | <i>M110</i> | <i>M2010</i> | <i>M107</i> |
|--|---|-------------------|--------------------------------|------------|-------------|--------------|-------------|
| 0 | Cold bore | | Bottom box, cold bore | A-8 | Y | Y | Y |
| 1 | Chronograph group | 2 x 5 rounds | Top circle, top triangle | A-8 | Y | Y | Y |
| 2A | Zeroing, primary optic | 2 x 5 rounds | Top square, top diamond | A-8 | Y | Y | Y |
| 2B | Zeroing, BUIS | 2 x 5 rounds | Bottom circle, bottom triangle | A-8 | Y | N/A | Y |
| 2C | Zeroing, thermal | 2 x 5 rounds | Bottom square (thermal) | A-8 | Y | Y | Y |
| 2D | Zeroing, pointer, illuminator, laser | 2 x 5 rounds | Bottom square (thermal) | A-8 | Y | Y | N/A |
| 3A | Confirmation at distance, primary optic | 2 x 5 rounds | 500 meter SAT w/ LOMAH | E-1 D-1 | Y | Y | Y |
| 3B | Confirmation at distance, BUIS | 2 x 5 rounds | 500 meter SAT w/ LOMAH | E-1 D-1 | Y | N/A | Y |
| 3C | Confirmation at distance, thermal | 2 x 5 rounds | 500 meter SAT w/ LOMAH | E-1 D-1 | Y | Y | Y |
| 3D | Confirmation at distance, pointer, illuminator, laser | 2 x 5 rounds | 500 meter SAT w/ LOMAH | E-1 D-1 | Y | Y | N/A |
| Note. All grouping and zeroing tasks utilize five round shot groups. Spotting scope must have the sniper lightweight integrator combat Kit (SLICK), NSN 1006-01-672-7773, attached to provide spotting capability during limited visibility. Units that do not have thermal optics for their weapons must coordinate for their use for Tables IV, V, and VI. | | | | | | | |
| Legend: BUIS – backup iron sight; ENG – engagement, LOMAH – location of miss and hit; TGT – target, SAT – stationary Armor target, N/A – not applicable, NSN – national stock number, w – with, Y - yes | | | | | | | |

G-33. To successfully complete Table IV tasks, firers must meet the unit standard for their iron sight and optic when assigned. Table G-20 provides each sniper weapon system's grouping and zeroing standards.

Table G-20. Shot group, grouping, and zeroing standards

| <i>Type</i> | <i>Standard</i> | | | <i>Progression Requirement</i> |
|--|----------------------------------|----------------------------------|----------------------------------|--|
| | <i>M107</i> | <i>M110</i> | <i>M2010</i> | |
| Shot group | 3 MOA | 2 MOA | 2 MOA | Four of five rounds (80-percent) within shot group standard. |
| Chronograph grouping | 3 MOA | 2 MOA | 2 MOA | Two consecutive standard shot groups (10-round string required). |
| Zeroing complete | 3 MOA | 2 MOA | 2 MOA | Standard shot group centered at the POA. |
| Confirmation at distance | 8 of 10 rounds 3 MOA at 500m. | 8 of 10 rounds 2 MOA at 500m. | 8 of 10 rounds 2 MOA at 500m. | Required for all primary optics, BUIS, and attachments (pointer / illuminator / laser, thermal optic) confirmations. |
| Legend: BUIS – backup iron sight, MOA – minute of angle, POA – point of aim, m – meters | | | | |

G-34. Figure G-4, on page G-22, is an example of a shot group size and zeroing standard. This is a guide for the leader. See TC 3-22.10 and the appropriate TMs for detailed instructions.

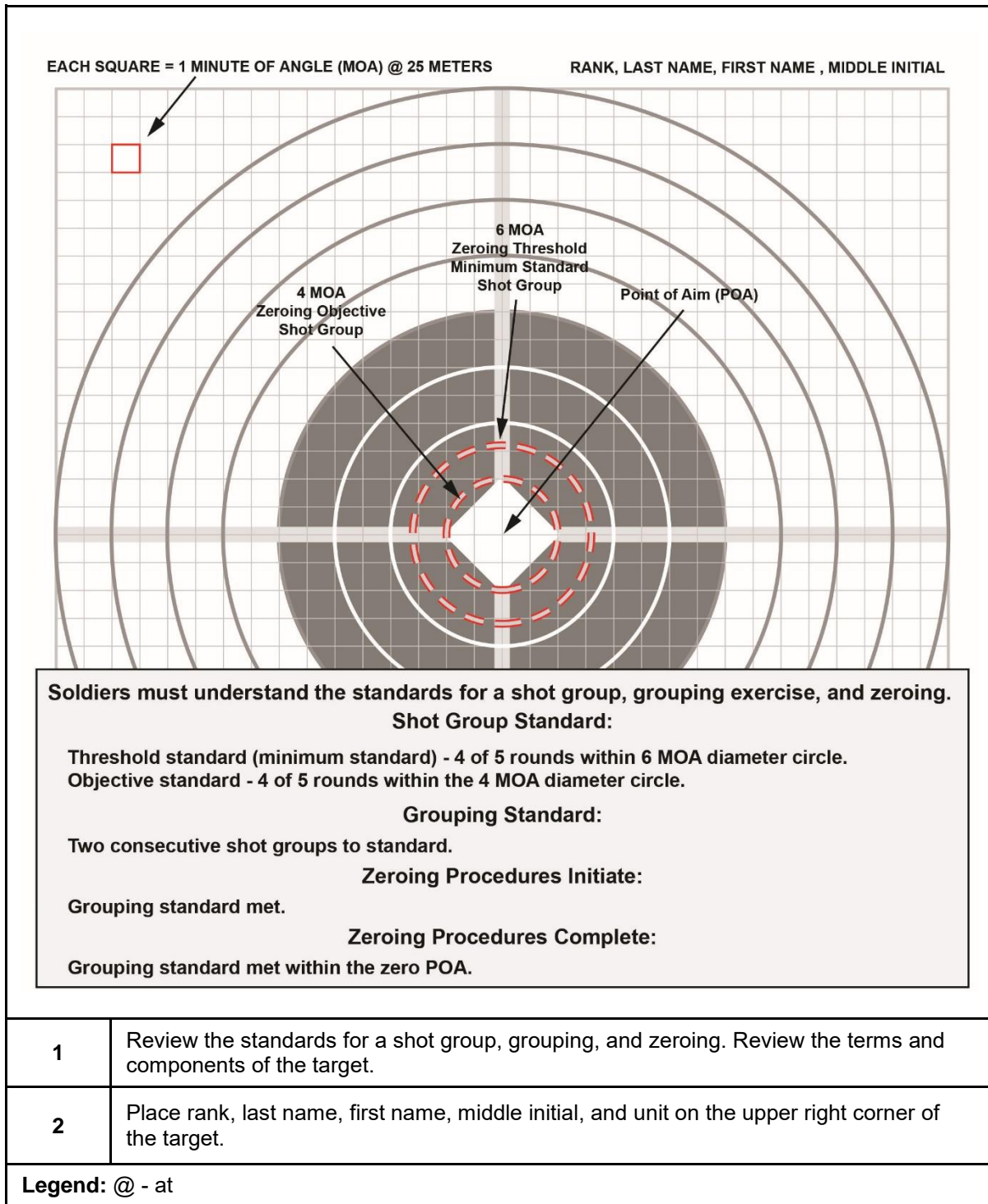

Figure G-4. Sniper rifle shot group and zeroing standard

G-35. Snipers begin Table IV tasks by moving into the firing position with the use of administrative commands from the tower operator. Tower operators use administrative commands to control the flow of the range, movement of personnel, and other command and control actions. Table G-21 provides an example of the administrative commands for moving a new firing order into position.

G-36. Snipers enter the range and move to their firing points. Once at the firing point, snipers assume a prone, supported firing position with their weapon in a green weapons safety status. Snipers fire the tasks in Table IV from the prone, supported position for each group.

Table G-21. Table IV, new firing order, conduct of the range example

| New Firing Order, Conduct of the Range | | | |
|--|--|---|----------------|
| | Task | Target | Target Type |
| | New Firing Order | N/A | N/A |
| | Rounds per Target | DODIC | Time (Seconds) |
| | N/A | AA11 (M110) A191 (M2010) A552 (M107) | NO LIMIT |
| TOWER | | SNIPER TEAM ACTION | |
| SNIPERS ARE IN A GREEN STATUS | | | |
| CONDUCT OF THE RANGE | SNIPER TEAM (SIERRA TANGO ONE) | | |
| | SECURE YOUR WEAPON AND AMMUNITION ONCE COMPLETE, MOVE TO YOUR FIRING POINT. | Snipers secure their magazines and ammunition then move to their designated firing point. | |
| SNIPERS ARE IN A GREEN STATUS | | | |
| Once all snipers are at their FIRING POINT, the tower continues. | | | |
| Legend: DODIC – Department of Defense identification code, N/A – not applicable | | | |

Note. If a malfunction occurs during any engagement, Soldiers must apply immediate action to their weapon then continue the engagement, as appropriate. Where immediate or remedial action does not correct the malfunction, Soldiers notify their respective lane safety.

G-37. As soon as the tower operator confirms all snipers are at the appropriate firing point, they initiate the first engagement. Table G-22 lists the commands for the first engagement.

Table G-22. Table IV, engagement 0, cold bore shot, conduct of fire example

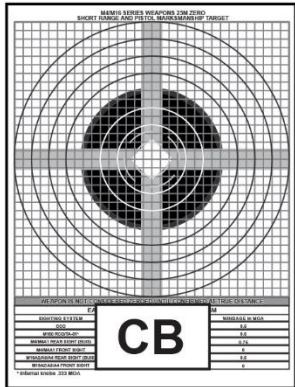
| <i>Table IV, Engagement 0 – Cold Bore</i> | | | |
|---|---|---|-----------------------|
|  | COLD BORE | Target | Target Type |
| | ENG 0 | A-8 | Zero / Bull Ring |
| | Rounds per Engagement | DODIC | Time (Seconds) |
| | 1 | AA11 (M110) A191 (M2010) A552 (M107) | NO LIMIT |
| TOWER | | SNIPER ACTION | |
| WEAPONS SAFETY STATUS RED | GO TO PRONE MAKE READY | Snipers establish a PRONE SUPPORTED firing position and load the appropriate magazine. | |
| ALERT | SIERRA TANGO (ONE) | | |
| TARGET DESCRIPTION | COLD BORE | | |
| RANGE | 100 METERS | | |
| CONTROL | SINGLE ROUND SLOW FIRE WEAPONS FREE WEAPONS FREE | | |
| EXECUTION | ENGAGE UPON POSITIVE IDENTIFICATION | Sniper begins slow firing a one-round cold bore shot. | |
| TOWER AWAITS ALL SNIPERS TO COMPLETE THE COLD BORE SHOT. | | | |
| TERMINATION | CEASE FIRE CEASE FIRE | Sniper remains in a RED status. | |
| Once all snipers are complete, the tower directs: PREPARE FOR CHRONOGRAPH AND GROUPING. REPORT WHEN SET. | | | |
| Legend: CB – cold bore, DODIC – Department of Defense identification code, ENG – engagement, | | | |

G-38. Once all snipers have completed the cold bore shot, the sniper, spotter, and sniper team leader prepare for the chronograph, grouping, and zeroing engagements and report SET to the tower operator. Once all snipers report SET, the tower operator prepares for the next engagement, shown in table G-23. The tower operator's initial command initiates the sniper team to MAKE READY.

Table G-23. Table IV, engagement 1, group 1, chronograph and group, conduct of fire example

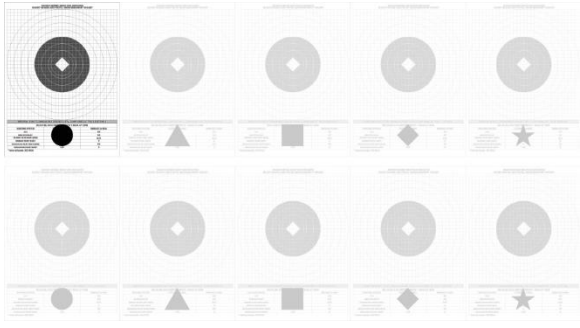
| <i>Table IV, Engagement 1, Group 1 – Chronograph and Group</i> | | | |
|---|--|---|-----------------------|
|  | CHRONO GROUP | Target | Target Type |
| | 1-1 | A-8 | Zero / Bull Ring |
| | Rounds per Engagement | DODIC | Time (Seconds) |
| | 5 | AA11 (M110) A191 (M2010) A552 (M107) | NO LIMIT |
| TOWER | | SNIPER ACTION | |
| WEAPONS SAFETY STATUS RED | MAKE READY | Snipers establish a PRONE SUPPORTED firing position. Sniper loads appropriate magazine. | |
| ALERT | SIERRA TANGO (ONE) | | |
| TARGET DESCRIPTION | TOP CIRCLE | | |
| RANGE | 100 METERS | | |
| CONTROL | CHRONOGRAPH FIVE ROUNDS SLOW FIRE WEAPONS FREE WEAPONS FREE | | |
| EXECUTION | ENGAGE UPON POSITIVE IDENTIFICATION | Sniper begins slow firing a five-round shot group, ensuring the same point of aim for each round. | |
| TOWER AWAITS ALL SNIPERS TO COMPLETE THE FIVE-ROUND GROUP | | | |
| TERMINATION | CEASE FIRE CEASE FIRE | Sniper remains in a RED status. | |
| Once all snipers are complete, the tower directs: DETERMINE MUZZLE VELOCITY AVERAGE AND MEAN POINT OF IMPACT. MAKE NECESSARY ADJUSTMENTS. REPORT WHEN SET. | | | |
| Legend: CHRONO – chronograph, DODIC – Department of Defense identification code | | | |

G-39. Once all snipers have completed the shot group, the sniper makes the appropriate adjustments. Once complete, the sniper team reports SET to the tower operator. Once all snipers report SET, the tower operator prepares for the next engagement, shown in table G-24. The tower operator’s initial command initiates the sniper team to MAKE READY.

Table G-24. Table IV, engagement 1, group 2, chronograph and group example

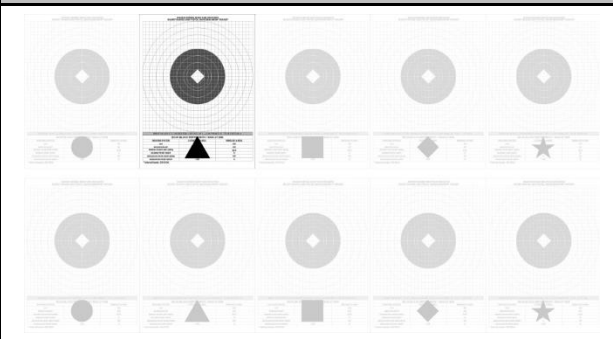
| <i>Table IV, Engagement 1 Group 2 – Chronograph and Group</i> | | | |
|---|--|---|------------------|
|  | CHRONO GROUP | Target | Target Type |
| | 1-2 | A-8 | Zero / Bull Ring |
| | Rounds per Engagement | DODIC | Time (Seconds) |
| | 5 | AA11 (M110) A191 (M2010) A552 (M107) | NO LIMIT |
| TOWER | | SNIPER ACTION | |
| WEAPONS SAFETY STATUS RED | MAKE READY | Snipers refine their PRONE SUPPORTED firing position. Sniper loads magazine, as appropriate. | |
| ALERT | SIERRA TANGO (ONE) | | |
| TARGET DESCRIPTION | TOP TRIANGLE | | |
| RANGE | 100 METERS | | |
| | CHRONOGRAPH | | |
| | FIVE ROUNDS | | |
| CONTROL | SLOW FIRE | | |
| | WEAPONS FREE WEAPONS FREE | | |
| EXECUTION | ENGAGE UPON POSITIVE IDENTIFICATION | Sniper begins slow firing a five-round shot group, ensuring the same point of aim for each round. | |
| TOWER AWAITS ALL SNIPERS TO COMPLETE THE FIVE-ROUND GROUP | | | |
| TERMINATION | CEASE FIRE CEASE FIRE | Sniper remains in a RED status. | |
| THIS SHOULD COMPLETE YOUR CHRONOGRAPH VERIFICATION. DETERMINE MUZZLE VELOCITY AVERAGE AND MEAN POINT OF IMPACT. MAKE NECESSARY ADJUSTMENTS. REPORT WHEN SET. | | | |
| Legend: CHRONO – chronograph, DODIC – Department of Defense identification code | | | |

G-40. Once all snipers have completed the shot group, the sniper makes the appropriate adjustments. Once complete, the sniper team reports SET to the tower operator. Once all snipers report SET, the tower operator prepares for the next engagement, shown in table G-25. The tower operator’s initial command initiates the sniper team to MAKE READY.

Table G-25. Table IV, engagement 2A, group 1, zeroing, primary optic, conduct of fire example

| <i>Table IV, Engagement 2A, Group 1 – Zeroing, Primary Optic</i> | | | |
|---|--|---|-----------------------|
| | Zero Group | Target | Target Type |
| | 2A-1 | A-8 | Zero / Bull Ring |
| | Rounds per Engagement | DODIC | Time (Seconds) |
| | 5 | AA11 (M110) A191 (M2010) A552 (M107) | NO LIMIT |
| TOWER | | SNIPER ACTION | |
| WEAPONS SAFETY STATUS RED | MAKE READY | Snipers refine their PRONE SUPPORTED firing position. Sniper loads magazine, as appropriate. | |
| ALERT | SIERRA TANGO (ONE) | | |
| TARGET DESCRIPTION | TOP SQUARE | | |
| RANGE | 100 METERS | | |
| | FIVE ROUNDS | | |
| CONTROL | SLOW FIRE | | |
| | WEAPONS FREE WEAPONS FREE | | |
| EXECUTION | ENGAGE UPON POSITIVE IDENTIFICATION | Sniper begins slow firing a five-round shot group, ensuring the same point of aim for each round. | |
| TOWER AWAITS ALL SNIPERS TO COMPLETE THE FIVE-ROUND GROUP | | | |
| TERMINATION | CEASE FIRE CEASE FIRE | Sniper remains in a RED status. | |
| <p align="center">Once all snipers are complete, the tower directs: DETERMINE MEAN POINT OF IMPACT AND ADJUSTMENTS. REPORT WHEN SET.</p> | | | |
| Legend: DODIC – Department of Defense identification code | | | |

G-41. Once all snipers have completed the shot group, the sniper makes the appropriate adjustments. Once complete, the sniper team reports SET to the tower operator. Once all snipers report SET, the tower operator prepares for the next engagement, shown in table G-26. The tower operator’s initial command initiates the sniper team to MAKE READY.

Table G-26. Table IV, engagement 2A, group 2, zeroing, primary optic, conduct of fire example

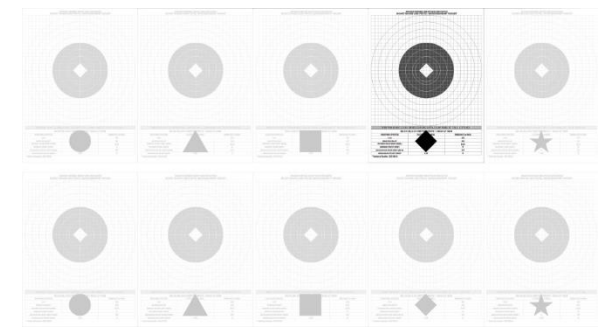
| <i>Table IV, Engagement 2A, Group 2 – Zeroing, Primary Optic</i> | | | |
|---|--|---|-----------------------|
|  | Zero Group | Target | Target Type |
| | 2A-2 | A-8 | Zero / Bull Ring |
| | Rounds per Engagement | DODIC | Time (Seconds) |
| | 5 | AA11 (M110) A191 (M2010) A552 (M107) | NO LIMIT |
| TOWER | | SNIPER ACTION | |
| WEAPONS SAFETY STATUS RED | MAKE READY | Snipers refine their PRONE SUPPORTED firing position. Sniper loads magazine, as appropriate. | |
| ALERT | SIERRA TANGO (ONE) | | |
| TARGET DESCRIPTION | TOP DIAMOND | | |
| RANGE | 100 METERS | | |
| | FIVE ROUNDS | | |
| CONTROL | SLOW FIRE | | |
| | WEAPONS FREE WEAPONS FREE | | |
| EXECUTION | ENGAGE UPON POSITIVE IDENTIFICATION | Sniper begins slow firing a five-round shot group, ensuring the same point of aim for each round. | |
| TOWER AWAITS ALL SNIPERS TO COMPLETE THE FIVE-ROUND GROUP | | | |
| TERMINATION | CEASE FIRE CEASE FIRE | Sniper remains in a RED status. | |
| Once all snipers are complete, the tower directs: DETERMINE MEAN POINT OF IMPACT AND ADJUSTMENTS. REPORT WHEN SET. | | | |
| Legend: DODIC – Department of Defense identification code | | | |

G-42. Once all snipers have completed the shot group, the sniper makes the appropriate adjustments. The next two groupings *are not* for the M2010 sniper weapons system. Once complete, the sniper team reports SET to the tower operator. Once all Snipers report SET, the tower operator prepares for the next engagement, shown in table G-27. The tower operator’s initial command initiates the sniper team to MAKE READY.

Table G-27. Table IV, engagement 2B, group 1, zeroing, iron / backup iron sight, example

| <i>Table IV, Engagement 2B, Group 1 – Zeroing, Iron / BUIS</i> | | | |
|---|--|---|-----------------------|
| | BUIS Zero Group | Target | Target Type |
| | 2B-1 | A-8 | Zero / Bull Ring |
| | Rounds per Engagement | DODIC | Time (Seconds) |
| | 5 | AA11 (M110) NOT FOR M2010 A552 (M107) | NO LIMIT |
| TOWER | | SNIPER ACTION | |
| WEAPONS SAFETY STATUS RED | MAKE READY | Snipers refine their PRONE SUPPORTED firing position. Sniper loads magazine, as appropriate. | |
| ALERT | SIERRA TANGO (ONE) | | |
| TARGET DESCRIPTION | TOP STAR | | |
| RANGE | 100 METERS | NOT FOR M2010 | |
| | IRONS | | |
| | FIVE ROUNDS | | |
| CONTROL | SLOW FIRE | | |
| | WEAPONS FREE WEAPONS FREE | | |
| EXECUTION | ENGAGE UPON POSITIVE IDENTIFICATION | Sniper begins slow firing a five-round shot group, ensuring the same point of aim for each round. | |
| TOWER AWAITS ALL SNIPERS TO COMPLETE THE FIVE-ROUND GROUP | | | |
| TERMINATION | CEASE FIRE CEASE FIRE | Sniper remains in a RED status. | |
| Once all snipers are complete, the tower directs: DETERMINE MEAN POINT OF IMPACT AND ADJUSTMENTS. REPORT WHEN SET. | | | |
| Legend: BUIS – backup iron sight, DODIC – Department of Defense identification code | | | |

G-43. Once all snipers have completed the shot group, the sniper makes the appropriate adjustments. The next grouping *is not* for the M2010 sniper weapons system. Once complete, the sniper team reports SET to the tower operator. Once all snipers report SET, the tower operator prepares for the next engagement, shown in table G-28. The tower operator’s initial command initiates the sniper team to MAKE READY.

Table G-28. Table IV, engagement 2B, group 2, zeroing, iron / backup iron sight, example

| <i>Table IV, Engagement 2B, Group 2 – Zeroing, Iron / BUIS</i> | | | |
|---|--|---|-----------------------|
| | BUIS Zero Group | Target | Target Type |
| | 2B-2 | A-8 | Zero / Bull Ring |
| | Rounds per Engagement | DODIC | Time (Seconds) |
| | 5 | AA11 (M110) NOT FOR M2010 A552 (M107) | NO LIMIT |
| TOWER | | SNIPER ACTION | |
| WEAPONS SAFETY STATUS RED | MAKE READY | Snipers refine their PRONE SUPPORTED firing position. Sniper loads magazine, as appropriate. | |
| ALERT | SIERRA TANGO (ONE) | | |
| TARGET DESCRIPTION | BOTTOM CIRCLE | | |
| RANGE | 100 METERS | NOT FOR M2010 | |
| | IRONS | | |
| | FIVE ROUNDS | | |
| CONTROL | SLOW FIRE | | |
| | WEAPONS FREE WEAPONS FREE | | |
| EXECUTION | ENGAGE UPON POSITIVE IDENTIFICATION | Sniper begins slow firing a five-round shot group, ensuring the same point of aim for each round. | |
| TOWER AWAITS ALL SNIPERS TO COMPLETE THE FIVE-ROUND GROUP | | | |
| TERMINATION | CEASE FIRE CEASE FIRE | Sniper remains in a RED status. | |
| Once all snipers are complete, the tower directs: DETERMINE MEAN POINT OF IMPACT AND ADJUSTMENTS. REPORT WHEN SET. | | | |
| Legend: BUIS – backup iron sight, DODIC – Department of Defense identification code | | | |

G-44. All snipers will switch to their attached thermal optic for the zeroing attachments engagements. For units without thermal optics available, they must coordinate for the appropriate AN/PAS-13v2 or similar equipment. The tower operator's initial command initiates the firer to MAKE READY, as shown in table G-29. The snipers use this target for both five-round groups. Units may add additional targets, as necessary.

Table G-29. Table IV, engagement 2C, group 1, zeroing, thermal, conduct of fire example

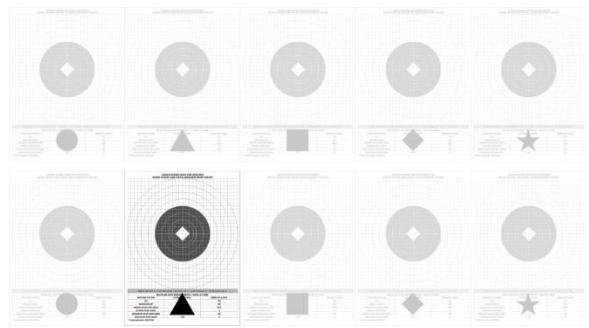
| <i>Table IV, Engagement 2C, Group 1 – Zeroing, Thermal</i> | | | |
|---|--|---|-----------------------|
|  | Zeroing Thermal | Target | Target Type |
| | 2C-1 | A-8 THERMAL POA | Zero / Bull Ring |
| | Rounds per Engagement | DODIC | Time (Seconds) |
| | 5 | AA11 (M110) A191 (M2010) A552 (M107) | NO LIMIT |
| TOWER | | SNIPER ACTION | |
| WEAPONS SAFETY STATUS RED | MAKE READY | Snipers refine their PRONE SUPPORTED firing position. Sniper loads magazine, as appropriate. | |
| ALERT | SIERRA TANGO (ONE) | | |
| TARGET DESCRIPTION | BOTTOM TRIANGLE | | |
| RANGE | 100 METERS | | |
| | THERMAL | | |
| | FIVE ROUNDS | | |
| CONTROL | SLOW FIRE | | |
| | WEAPONS FREE WEAPONS FREE | | |
| EXECUTION | ENGAGE UPON POSITIVE IDENTIFICATION | Sniper begins slow firing a five-round shot group, ensuring the same point of aim for each round. | |
| TOWER AWAITS ALL SNIPERS TO COMPLETE THE FIVE-ROUND GROUP | | | |
| TERMINATION | CEASE FIRE CEASE FIRE | Sniper remains in a RED status. | |
| Once all snipers are complete, the tower directs: DETERMINE MEAN POINT OF IMPACT AND ADJUSTMENTS. REPORT WHEN SET. | | | |
| Legend: DODIC – Department of Defense Identification code, POA – point of aim | | | |

G-45. Once all firers have completed group 1, they report SET to the tower operator. The tower operator continues to the second zeroing thermal group by directing snipers to MAKE READY, as shown in table G-30. Units may add additional targets, as necessary.

Table G-30. Table IV, engagement 2C, group 2, zeroing, thermal, conduct of fire example

| <i>Table IV, Engagement 2C, Group 2 – Zeroing, Thermal</i> | | | |
|---|--|---|-----------------------|
| | Zero Thermal | Target | Target Type |
| | 2C-2 | A-8 THERMAL POA | Zero / Bull Ring |
| | Rounds per Engagement | DODIC | Time (Seconds) |
| | 5 | AA11 (M110) A191 (M2010) A552 (M107) | NO LIMIT |
| TOWER | | SNIPER ACTION | |
| WEAPONS SAFETY STATUS RED | MAKE READY | Snipers refine their PRONE SUPPORTED firing position. Sniper loads magazine, as appropriate. | |
| ALERT | SIERRA TANGO (ONE) | | |
| TARGET DESCRIPTION | BOTTOM SQUARE | | |
| RANGE | 100 METERS | | |
| | THERMAL | | |
| | FIVE ROUNDS | | |
| CONTROL | SLOW FIRE | | |
| | WEAPONS FREE WEAPONS FREE | | |
| EXECUTION | ENGAGE UPON POSITIVE IDENTIFICATION | Sniper begins slow firing a five-round shot group, ensuring the same point of aim for each round. | |
| TOWER AWAITS ALL SNIPERS TO COMPLETE THE FIVE-ROUND GROUP | | | |
| TERMINATION | CEASE FIRE CEASE FIRE | Sniper remains in a RED status. | |
| Once all snipers are complete, the tower directs: DETERMINE MEAN POINT OF IMPACT AND ADJUSTMENTS. REPORT WHEN SET. | | | |
| Legend: DODIC – Department of Defense identification code, POA – point of aim | | | |

G-46. All snipers switch to their attached pointers, illuminators, and lasers (M110 and M2010) for the zeroing attachments engagements. The next group *is not* for the M107 sniper weapon system. The tower operator's initial command initiates the firer to MAKE READY, as shown in table G-31. Snipers use this target for both five-round groups. Units may add additional targets, as necessary.

Table G-31. Table IV, engagement 2D, group 1, zeroing, attachments, conduct of fire example

| <i>Table IV, Engagement 2D, Group 1 – Zeroing, Attachments</i> | | | |
|---|--|---|-----------------------|
| | Zeroing Attachments | Target | Target Type |
| | 2D-1 | A-8 THERMAL POA | Zero / Bull Ring |
| | Rounds per Engagement | DODIC | Time (Seconds) |
| | 5 | AA11 (M110) A191 (M2010) NOT FOR M107 | NO LIMIT |
| TOWER | | SNIPER ACTION | |
| WEAPONS SAFETY STATUS RED | MAKE READY | Snipers refine their PRONE SUPPORTED firing position. Sniper loads magazine, as appropriate. | |
| ALERT | SIERRA TANGO (ONE) | | |
| TARGET DESCRIPTION | BOTTOM DIAMOND | | |
| RANGE | 100 METERS | NOT FOR M107 | |
| | LASER | | |
| | FIVE ROUNDS | | |
| CONTROL | SLOW FIRE | | |
| | WEAPONS FREE WEAPONS FREE | | |
| EXECUTION | ENGAGE UPON POSITIVE IDENTIFICATION | Sniper begins slow firing a five-round shot group, ensuring the same point of aim for each round. | |
| TOWER AWAITS ALL SNIPERS TO COMPLETE THE FIVE-ROUND GROUP | | | |
| TERMINATION | CEASE FIRE CEASE FIRE | Sniper remains in a RED status. | |
| Once all snipers are complete, the tower directs: DETERMINE MEAN POINT OF IMPACT AND ADJUSTMENTS. REPORT WHEN SET. | | | |
| Legend: DODIC – Department of Defense identification code, POA – point of aim | | | |

G-47. All snipers switch to their attached pointers, illuminators, and lasers (M110 and M2010) for the zeroing attachments engagements. The next group *is not* for the M107 sniper weapon system. The tower operator's initial command initiates the firer to MAKE READY, as shown in table G-32. Snipers use this target for both five-round groups. Units may add additional targets, as necessary.

Table G-32. Table IV, engagement 2D, group 2, zeroing, attachments, conduct of fire example

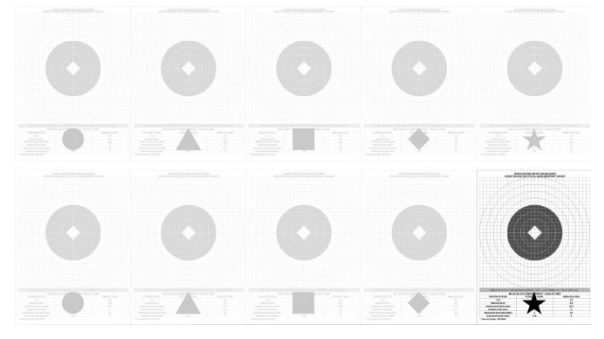
| <i>Table IV, Engagement 2D, Group 2 – Zeroing, Attachments</i> | | | |
|--|--|---|------------------|
|  | Zero Attachments | Target | Target Type |
| | 2D-2 | A-8 THERMAL POA | Zero / Bull Ring |
| | Rounds per Engagement | DODIC | Time (Seconds) |
| | 5 | AA11 (M110) A191 (M2010) NOT FOR M107 | NO LIMIT |
| TOWER | | SNIPER ACTION | |
| WEAPONS SAFETY STATUS RED | MAKE READY | Snipers refine their PRONE SUPPORTED firing position. Sniper loads magazine, as appropriate. | |
| ALERT | SIERRA TANGO (ONE) | | |
| TARGET DESCRIPTION | BOTTOM STAR | | |
| RANGE | 100 METERS | NOT FOR M107 | |
| | LASER | | |
| | FIVE ROUNDS | | |
| CONTROL | SLOW FIRE | | |
| | WEAPONS FREE WEAPONS FREE | | |
| EXECUTION | ENGAGE UPON POSITIVE IDENTIFICATION | Sniper begins slow firing a five-round shot group, ensuring the same point of aim for each round. | |
| TOWER AWAITES ALL SNIPERS TO COMPLETE THE FIVE-ROUND GROUP | | | |
| TERMINATION | CEASE FIRE CEASE FIRE | Sniper remains in a RED status. | |
| Once all snipers are complete, the tower directs: DETERMINE MEAN POINT OF IMPACT AND ADJUSTMENTS. REPORT WHEN SET. | | | |
| Legend: DODIC – Department of Defense identification code, POA – point of aim | | | |

G-48. Once all firers have completed all grouping and zeroing for their primary optic, iron sights, BUIS, and attached optics or devices, and annotated and applied the adjustments to their weapon or optic, the tower operator prepares for confirmation at distance, shown in table G-33. The tower operator’s initial command initiates the firer to GO TO PRONE and MAKE READY.

Table G-33. Table IV, engagement 3A, group 1, confirmation at distance, conduct of fire example

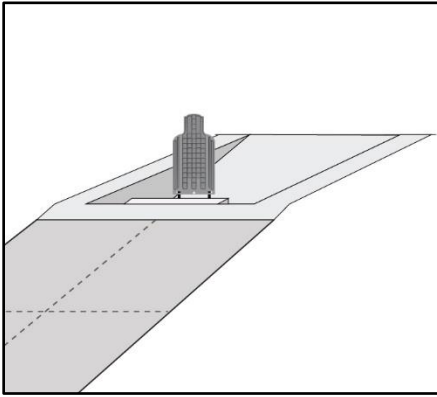
| <i>Table IV, Engagement 3A, Group 1 – Confirmation at Distance, Primary Optic</i> | | | |
|--|--|---|-----------------------|
|  | Confirm at Distance | Target | Target Type |
| | 3A-1 | E-1 D-1 | Silhouette LOMAH |
| | Rounds per Engagement | DODIC | Time (Seconds) |
| | 5 | AA11 (M110) A191 (M2010) A552 (M107) | NO LIMIT |
| TOWER | | SNIPER ACTION | |
| WEAPONS SAFETY STATUS RED | MAKE READY | Snipers refine their PRONE SUPPORTED firing position. Sniper loads magazine, as appropriate. | |
| ALERT | SIERRA TANGO (ONE) | | |
| TARGET DESCRIPTION | TROOP | | |
| RANGE | 500 METERS | | |
| | PRIMARY OPTIC | | |
| | FIVE ROUNDS | | |
| CONTROL | SLOW FIRE | | |
| | WEAPONS FREE WEAPONS FREE | | |
| EXECUTION | ENGAGE UPON POSITIVE IDENTIFICATION | Sniper begins slow firing a five-round shot group, ensuring the same point of aim for each round. | |
| TOWER AWAITS ALL SNIPERS TO COMPLETE THE FIVE-ROUND GROUP | | | |
| TERMINATION | CEASE FIRE CEASE FIRE | Sniper remains in a RED status. | |
| | REPORT WHEN SET | | |
| Legend: DODIC – Department of Defense identification code, LOMAH – location of miss and hit | | | |

G-49. Once all snipers have completed the grouping, they make the necessary adjustments and report SET to the tower. The tower operator's command initiates the sniper to MAKE READY as shown in table G-34.

Table G-34. Table IV, engagement 3A-2, confirmation at distance 2, conduct of fire example

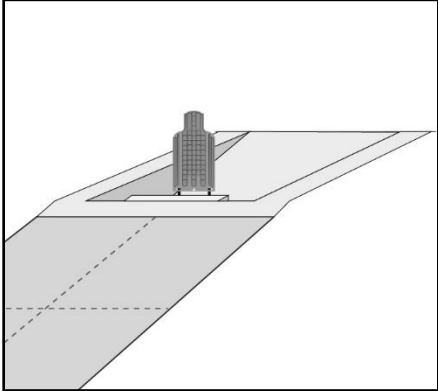
| <i>Table IV, Engagement 3A, Group 2 – Confirmation at Distance, Primary Optic</i> | | | |
|--|--|--|-----------------------|
|  | Confirm at Distance | Target | Target Type |
| | 3A-2 | E-1 D-1 | Silhouette LOMAH |
| | Rounds per Engagement | DODIC | Time (Seconds) |
| | 5 | AA11 (M110) A191 (M2010) A552 (M107) | NO LIMIT |
| TOWER | | SNIPER ACTION | |
| WEAPONS SAFETY STATUS RED | MAKE READY | Snipers refine their PRONE SUPPORTED firing position. Sniper loads magazine, as appropriate. | |
| ALERT | SIERRA TANGO (ONE) | | |
| TARGET DESCRIPTION | TROOP | | |
| RANGE | 500 METERS | | |
| | PRIMARY OPTIC | | |
| | FIVE ROUNDS | | |
| CONTROL | SLOW FIRE | | |
| | WEAPONS FREE WEAPONS FREE | | |
| EXECUTION | ENGAGE UPON POSITIVE IDENTIFICATION | Sniper begins slow firing a five-round shot group, ensuring the same point of aim for each round. | |
| TOWER AWAITS ALL SNIPERS TO COMPLETE THE FIVE-ROUND GROUP | | | |
| TERMINATION | CEASE FIRE CEASE FIRE | Sniper remains in a RED status. | |
| | REPORT WHEN SET | | |
| Legend: DODIC – Department of Defense identification code, LOMAH – location of miss and hit | | | |

G-50. Once all firers have completed firing, annotated the appropriate adjustments on their target, and applied the adjustments to their weapon or optic, the tower operator prepares for the next engagement, shown in table G-35. This engagement *is not* for the M2010 sniper weapon system. The tower operator's initial command initiates the firer to MAKE READY.

Table G-35. Table IV, engagement 3B-1, iron / backup iron sight, confirmation at distance 1, conduct of fire example

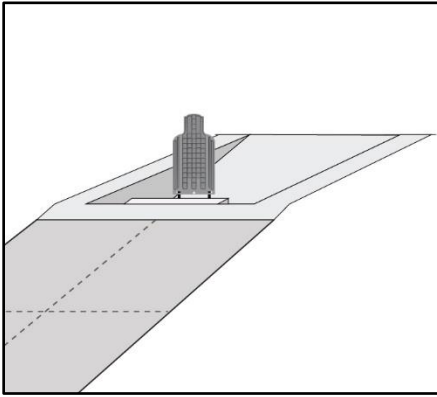
| <i>Table IV, Engagement 3B, Group 1 – Confirmation at Distance, Iron Sight / BUIS</i> | | | |
|--|--|--|-----------------------|
|  | Confirm at Distance IRON / BUIS | Target | Target Type |
| | 3B-1 | E-1 D-1 | Silhouette LOMAH |
| | Rounds per Engagement | DODIC | Time (Seconds) |
| | 5 | AA11 (M110) NOT FOR M2010 A552 (M107) | NO LIMIT |
| TOWER | | SNIPER ACTION | |
| WEAPONS SAFETY STATUS RED | MAKE READY | Snipers refine their PRONE SUPPORTED firing position. Sniper loads magazine, as appropriate. | |
| ALERT | SIERRA TANGO (ONE) | | |
| TARGET DESCRIPTION | TROOP | | |
| RANGE | 500 METERS | NOT FOR M2010 | |
| | IRONS | | |
| | FIVE ROUNDS | | |
| CONTROL | SLOW FIRE | | |
| | WEAPONS FREE WEAPONS FREE | | |
| EXECUTION | ENGAGE UPON POSITIVE IDENTIFICATION | Sniper begins slow firing a five-round shot group, ensuring the same point of aim for each round. | |
| TOWER AWAITS ALL SNIPERS TO COMPLETE THE FIVE-ROUND GROUP | | | |
| TERMINATION | CEASE FIRE CEASE FIRE | Sniper remains in a RED status. | |
| | REPORT WHEN SET | | |
| Legend: BUIS – backup iron sight, DODIC – Department of Defense identification code, LOMAH – location of miss and hit | | | |

G-51. Once all firers have completed firing, annotated the appropriate adjustments, and applied the adjustments to their weapon and optic, the tower operator prepares for the next engagement shown in table G-36. This engagement *is not* for the M2010. The tower operator's initial command initiates the firer to MAKE READY.

Table G-36. Table IV, engagement 3B-2, backup iron sight confirmation at distance 2, conduct of fire example

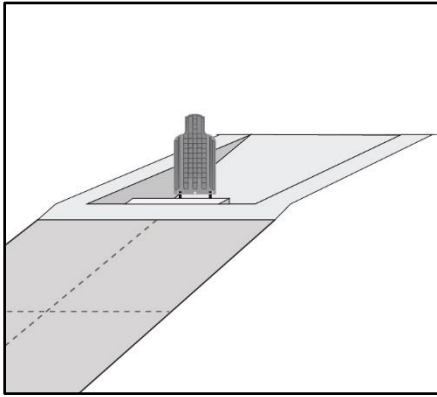
| Table IV, Engagement 3B, Group 2 – Confirmation at Distance, BUIS | | | |
|--|--|--|-----------------------|
|  | Confirm at Distance BUIS | Target | Target Type |
| | 3B-2 | E-1 D-1 | Silhouette LOMAH |
| | Rounds per Engagement | DODIC | Time (Seconds) |
| | 5 | AA11 (M110) NOT FOR M2010 A552 (M107) | NO LIMIT |
| TOWER | | SNIPER ACTION | |
| WEAPONS SAFETY STATUS RED | MAKE READY | Snipers refine their PRONE SUPPORTED firing position. Sniper loads magazine, as appropriate. | |
| ALERT | SIERRA TANGO (ONE) | | |
| TARGET DESCRIPTION | TROOP | | |
| RANGE | 500 METERS | NOT FOR M2010 | |
| | IRONS | | |
| | FIVE ROUNDS | | |
| CONTROL | SLOW FIRE | | |
| | WEAPONS FREE WEAPONS FREE | | |
| EXECUTION | ENGAGE UPON POSITIVE IDENTIFICATION | Sniper begins slow firing a five-round shot group, ensuring the same point of aim for each round. | |
| TOWER AWAITS ALL SNIPERS TO COMPLETE THE FIVE-ROUND GROUP | | | |
| TERMINATION | CEASE FIRE CEASE FIRE | Sniper remains in a RED status. | |
| | REPORT WHEN SET | | |
| Legend: BUIS – backup iron sight, DODIC – Department of Defense identification code, LOMAH – location of miss and hit | | | |

G-52. Once all firers have completed firing, annotated the appropriate adjustments, and applied the adjustments to their weapon and optic, the tower operator prepares for confirmation at distance for their attached equipment shown in table G-37. The tower operator's initial command initiates the firer to MAKE READY.

Table G-37. Table IV, engagement 3C-1, thermal confirmation at distance 1, conduct of fire example

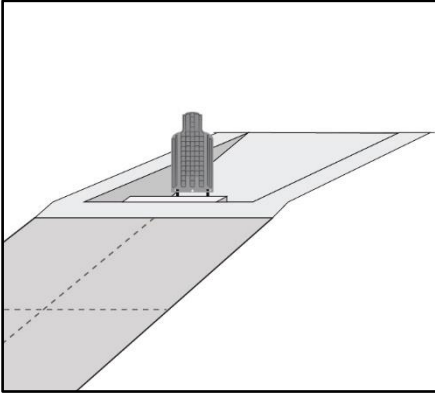
| <i>Table IV, Engagement 3C, Group 1 – Confirmation at Distance, Thermal</i> | | | |
|--|--|---|-----------------------|
|  | Confirm at Distance Thermal | Target | Target Type |
| | 3C-1 | E-1 D-1 | Silhouette LOMAH |
| | Rounds per Engagement | DODIC | Time (Seconds) |
| | 5 | AA11 (M110) A191 (M2010) A552 (M107) | NO LIMIT |
| TOWER | | SNIPER ACTION | |
| WEAPONS SAFETY STATUS RED | MAKE READY | Snipers refine their PRONE SUPPORTED firing position. Sniper loads magazine, as appropriate. | |
| ALERT | SIERRA TANGO | | |
| TARGET DESCRIPTION | TROOP | | |
| RANGE | 500 METERS | | |
| | THERMAL | | |
| | FIVE ROUNDS | | |
| CONTROL | SLOW FIRE | | |
| | WEAPONS FREE WEAPONS FREE | | |
| EXECUTION | ENGAGE UPON POSITIVE IDENTIFICATION | Sniper begins slow firing a five-round shot group, ensuring the same point of aim for each round. | |
| TOWER AWAITS ALL SNIPERS TO COMPLETE THE FIVE-ROUND GROUP | | | |
| TERMINATION | CEASE FIRE CEASE FIRE | Sniper remains in a RED status. | |
| | REPORT WHEN SET | | |
| Legend: DODIC – Department of Defense identification code, LOMAH – location of miss and hit | | | |

G-53. Once all firers have completed firing, annotated the appropriate adjustments, and applied the adjustments to their weapon and optic, the tower operator prepares for the next engagement shown in table G-38. The tower operator's initial command initiates the firer to MAKE READY.

Table G-38. Table IV, engagement 3C-2, thermal confirmation at distance 2, conduct of fire example

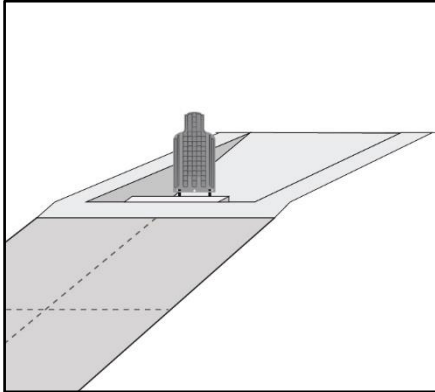
| <i>Table IV, Engagement 3C, Group 2 – Confirmation at Distance, Thermal</i> | | | |
|--|--|---|-----------------------|
|  | Confirm at Distance Thermal | Target | Target Type |
| | 3C-2 | E-1 D-1 | Silhouette LOMAH |
| | Rounds per Engagement | DODIC | Time (Seconds) |
| | 5 | AA11 (M110) A191 (M2010) A552 (M107) | NO LIMIT |
| TOWER | | SNIPER ACTION | |
| WEAPONS SAFETY STATUS RED | MAKE READY | Snipers refine their PRONE SUPPORTED firing position. Sniper loads magazine, as appropriate. | |
| ALERT | SIERRA TANGO (ONE) | | |
| TARGET DESCRIPTION | TROOP | | |
| RANGE | 500 METERS | | |
| | THERMAL | | |
| | FIVE ROUNDS | | |
| CONTROL | SLOW FIRE | | |
| | WEAPONS FREE WEAPONS FREE | | |
| EXECUTION | ENGAGE UPON POSITIVE IDENTIFICATION | Sniper begins slow firing a five-round shot group, ensuring the same point of aim for each round. | |
| TOWER AWAITS ALL SNIPERS TO COMPLETE THE FIVE-ROUND GROUP | | | |
| TERMINATION | CEASE FIRE CEASE FIRE | Sniper remains in a RED status. | |
| | REPORT WHEN SET | | |
| Legend: DODIC – Department of Defense identification code, LOMAH – location of miss and hit | | | |

G-54. Once all firers have completed firing, annotated the appropriate adjustments, and applied the adjustments to their weapon and optic, the tower operator prepares for confirmation at distance for their attached lasers shown in table G-39. This engagement *is not* for the M107. The tower operator’s initial command initiates the firer to MAKE READY.

Table G-39. Table IV, engagement 3D-1, attachments confirmation at distance 1, conduct of fire example

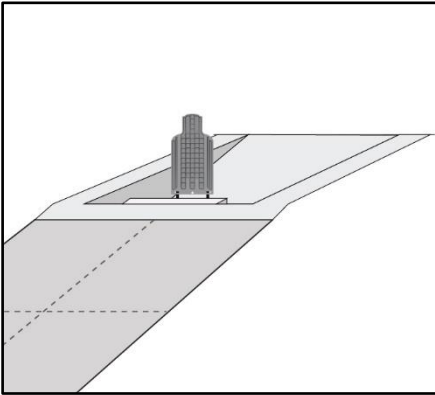
| <i>Table IV, Engagement 3D, Group 1 – Confirmation at Distance, Attachments</i> | | | |
|--|--|---|-----------------------|
|  | Confirm at Distance Attachments | Target | Target Type |
| | 3D-1 | E-1 D-1 | Silhouette LOMAH |
| | Rounds per Engagement | DODIC | Time (Seconds) |
| | 5 | AA11 (M110) A191 (M2010) NOT FOR M107 | NO LIMIT |
| TOWER | | SNIPER ACTION | |
| WEAPONS SAFETY STATUS RED | MAKE READY | Snipers refine their PRONE SUPPORTED firing position. Sniper loads magazine, as appropriate. | |
| ALERT | SIERRA TANGO (ONE) | | |
| TARGET DESCRIPTION | TROOP | | |
| RANGE | 500 METERS | NOT FOR M107 | |
| | LASER | | |
| | FIVE ROUNDS | | |
| CONTROL | SLOW FIRE | | |
| | WEAPONS FREE WEAPONS FREE | | |
| EXECUTION | ENGAGE UPON POSITIVE IDENTIFICATION | Sniper begins slow firing a five-round shot group, ensuring the same point of aim for each round. | |
| TOWER AWAITS ALL SNIPERS TO COMPLETE THE FIVE-ROUND GROUP | | | |
| TERMINATION | CEASE FIRE CEASE FIRE | Sniper remains in a RED status. | |
| | REPORT WHEN SET | | |
| Legend: DODIC – Department of Defense identification code, LOMAH – location of miss and hit | | | |

G-55. Once all firers have completed firing, annotated the appropriate adjustments, and applied the adjustments to their weapon or optic, the tower operator prepares for confirmation at distance for their attached lasers shown in table G-40. This engagement *is not* for the M107. The tower operator's initial command initiates the firer to MAKE READY.

Table G-40. Table IV, engagement 3D-2, attachments confirmation at distance 2, conduct of fire example

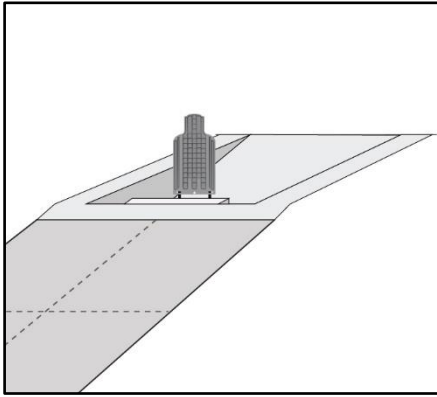
| Table IV, Engagement 3D, Group 2 – Confirmation at Distance, Attachments | | | |
|--|--|--|-----------------------|
|  | Confirm at Distance Attachments | Target | Target Type |
| | 3D-2 | E-1 D-1 | Silhouette LOMAH |
| | Rounds per Engagement | DODIC | Time (Seconds) |
| | 5 | AA11 (M110) A191 (M2010) NOT FOR M107 | NO LIMIT |
| TOWER | | SNIPER ACTION | |
| WEAPONS SAFETY STATUS RED | MAKE READY | Snipers refine their PRONE SUPPORTED firing position. Sniper loads magazine, as appropriate. | |
| ALERT | SIERRA TANGO (ONE) | | |
| TARGET DESCRIPTION | TROOP | | |
| RANGE | 500 METERS | NOT FOR M107 | |
| | LASER | | |
| | FIVE ROUNDS | | |
| CONTROL | SLOW FIRE | | |
| | WEAPONS FREE WEAPONS FREE | | |
| EXECUTION | ENGAGE UPON POSITIVE IDENTIFICATION | Sniper begins slow firing a five-round shot group, ensuring the same point of aim for each round. | |
| TOWER AWAITS ALL SNIPERS TO COMPLETE THE FIVE-ROUND GROUP | | | |
| TERMINATION | CEASE FIRE CEASE FIRE | Sniper remains in a RED status. | |
| | REPORT WHEN SET | | |
| Legend: DODIC – Department of Defense identification code, LOMAH – location of miss and hit | | | |

G-56. Once all snipers are set, the lane safety directs them to the 100-meter target frame to replace all paper targetry. Once the snipers are complete and back to the baseline, they collect their brass, ammunition, magazines, and dunnage from their firing position, after which the lane safety clears them.

G-57. The tower may direct certain snipers to remain on the firing point, as necessary. This includes snipers that must zero additional aiming devices. Those snipers require additional ammunition to complete the additional tasks.

G-58. Once all snipers have been verified green by the lane safety, the tower operator directs the firing order off the firing point. The tower operator, spotter, or sniper team leader must identify snipers who have failed to achieve the confirmation at distance standard (4 of 5 hits at zeroing distance) and move those snipers to a predetermined retraining location. Table G-41 provides a generic example of the conduct of the range instructions to change firing orders. All snipers on the range are in a green status.

Table G-41. Table IV, completed firing order, conduct of the range example

| Completed Firing Order, Conduct of the Range | | | |
|---|--|---------------|---|
| | Task | Target | Target Type |
| FIRING ORDER COMPLETE | Completed Firing Order | N/A | N/A |
| | Rounds per Target | DODIC | Time (Seconds) |
| | N/A | N/A | NO LIMIT |
| TOWER | SOLDIER ACTION | | |
| SNIPERS ARE IN A GREEN STATUS | | | |
| CONDUCT OF THE RANGE | SECURE YOUR DUNNAGE, MAGAZINES, AND AMMUNITION ONCE SET, MOVE TO THE BASELINE ENTRY CONTROL POINT | | Snipers secure weapon and ammunition dunnage and move to the designated location. |
| ONCE ALL SNIPERS HAVE EXITED THROUGH THE BASELINE ENTRY CONTROL POINT, THE TOWER DIRECTS THE MOVEMENT OF THE NEXT SNIPER FIRING ORDER. | | | |
| Legend: DODIC – Department of Defense identification code, N/A – not applicable | | | |

G-59. Sniper team leaders will review the shot groups with their snipers and spotters. They collect their grouping and zeroing targets for an AAR and verification of zeroing data. Snipers and sniper team leaders should maintain a record of the zeroing information, and review the targets for any firer errors during the shot process.

G-60. The tower operator records the completion of the firing order in the tower log and includes the number of snipers trained. The tower operator tabulates this information at the end of the firing day to change the firing status of the range to a cold or dry status with range operations.

SNIPER RIFLE, TABLE V, PRACTICE

G-61. Table V, Practice, is a practice table leaders use to prepare snipers for the qualification course of fire. The purpose of Table V is to challenge snipers with single stationary and moving targets out to the maximum effective range of the sniper weapon system, from various basic and advanced firing positions. Leaders use

Table V to train the sniper to use their primary and thermal optics, and assigned pointers, illuminators, and lasers to engage single targets placed in a tactical array.

G-62. In a timed scenario, the sniper experiences and learns target prioritization and weapons manipulation. This event is more rigorous than the qualification event where the targets are presented in a rapid tempo, and the time to transition between firing positions and tactical reloading are reduced.

G-63. Table V occurs on a SFF, HSR, MPMG, multipurpose range complex (or similar maneuver range) (known as MPRC), or comparable range facility. This course of fire is specifically designed to build the skills necessary to engage and defeat threats or high value targets from various firing conditions, including urban environments. For installations that do not provide the capabilities required of these engagements, refer to the authorized modification section.

G-64. Units may include a tactical movement or stalking lane between stages (day fire and night fire, assisted) to integrate tactical and live-fire training. Units will need to secure the appropriate training area(s) to support the tactical and stalking tasks.

TASK, CONDITIONS, AND STANDARD

G-65. Table G-42 outlines the task, conditions, and standard for the conduct of Table V tasks. The sniper conducting the event should know the task, conditions, and standard and should explain them during the range briefing.

Table G-42. Sniper Rifle, Table V, Practice

| | |
|--------------------|---|
| Task: | Engage and defeat single and multiple threats at varying ranges from supported or unsupported standing, kneeling, and prone firing positions, during day and limited visibility conditions using full-caliber ammunition. |
| Conditions: | <p>Given the following:</p> <ul style="list-style-type: none"> • Fully mission capable weapon as assigned on the master authorization list for the unit. • Assigned primary optic, thermal optic, and pointer, illuminator, laser system. • Full combat uniform, issued equipment, and protective mask. • Authorized range facility. • Full-scale, approved targetry in standard scenario engagement sequences. • Authorized ammunition. • Trained and certified spotter. <p>Note. Units that do not have organic thermal weapon sights for the M110 or M2010 must coordinate within their brigade for the appropriate thermal optic.</p> |
| Standard: | Demonstrate engagement proficiency by scoring a minimum of 140 points (70 percent) of the total points possible (200 points). |

G-66. Table G-43 shows the training event design template for Sniper Rifle, Table V, Practice. Leaders conduct this event on an authorized live-fire facility, typically an MPMG or MPRC or comparable range facility. See TC 25-8 for additional information on authorized range facilities.

Table G-43. Training event design template for Sniper Rifle, Table V, Practice

| Sniper Rifle, Table V, Practice | | | | | | |
|---|---------------------|---------------------------|-------------------------|---------------------------------------|--------------------------|---------------------------------|
| EVENT NAME: | PRACTICE | | ENVIRONMENT: | | LIVE | 1.0 |
| WEAPON: | M107 / M110 / M2010 | | CONDITIONS: | | LIVE FIRE | |
| CATEGORY: | LIVE FIRE | | PRIMARY FACILITY: | | SFF HSR | DAYS REQUIRED |
| PUBLICATION: | TC 3-22.10 | | ALTERNATE FACILITY: | | MPMG | |
| REQUIRED: | YES | | COMPONENT: | AC | RC | 48 SNIPERS |
| RECORD: | DA Form 7811 | | FREQUENCY: | 2 | 1 | |
| VALID FOR: | T-X | | ANNUAL DAYS TOTAL: | 2 | 1 | THROUGHPUT |
| | TABLE | | | | | |
| | I | II | III | IV | V | VI |
| | PMI&E | PLFS | DRILLS | BASIC | PRACTICE | QUAL |
| | PRQ | PRQ | PRQ | | | 1.0 |
| WHEN EXECUTED: | | | | | T-X | TNG DAYS TO QUAL |
| CONDEMNATION CRITERIA (CC) | RULE 1 | RULE 2 | RULE 3 | RULE 4 | RULE 5 | RULE 6 |
| | TIME | KEY LEADER TURNOVER | COMMANDER ASSESSMENT | SUBORDINATE ELEMENT PROFICIENCY | SPECIALTY PROFICIENCY | STAFF SECTION PROFICIENCY |
| Remarks: Each sniper assigned an individual weapon <i>must</i> successfully complete Table V, Practice tasks to gain experience with and confidence in their weapon, aiming devices, and tactical employment skills. | | | | | | |
| Legend: AC – active component (known as active duty), ARF – automated record fire range or similar, DA – Department of the Army, EVAL – evaluation, HSR – heavy sniper range, MPMG – multipurpose machine gun range, PLFS – preliminary live-fire simulation, PMI&E – preliminary marksmanship instruction and evaluation, PRQ – prerequisite, QUAL – qualification, RC – Reserve Component (known as Reserves), SFF – automated sniper field fire range, TC – training circular, T-X – training event exercise, TNG DAYS TO QUAL – number of training days remaining on the critical path to weapon's qualification | | | | | | |

AMMUNITION

G-67. All snipers assigned a sniper rifle on a unit MAL complete Sniper Rifle, Table V, Practice tasks prior to advancing to Table VI, Qualification. Leaders conduct this event to demonstrate the Soldier's proficiency to employ their sniper weapon system prior to conducting the qualification course of fire Table VI training.

G-68. To effectively plan and forecast for sufficient training ammunition, the unit will use the ammunition requirements listed in table G-44. Units need to identify the total number of snipers and weapon systems by type (caliber) and should plan for unscheduled firers and necessary retraining by increasing their forecasted training as appropriate.

G-69. Table V is an automated, timed event that consists of engagements from nine different firing points. Leaders issue ammunition to every sniper as shown in table G-44, on page G-46, to conduct the event to standard. Firers place ammunition in their ammunition pouches. Staging or pre-positioning ammunition is not authorized for the conduct of Table V.

Table G-44. Sniper Rifle, Table V, Practice, M110 ammunition and scenario requirements

| <i>Weapon</i> | <i>DODIC</i> | <i>Nomenclature</i> | <i>Stage 1 Day Fire</i> | <i>Stage 2 Night Fire Assisted</i> | <i>Total</i> |
|---------------|--------------|---|-------------------------|------------------------------------|--------------|
| M110 | A111 | CTG, 7.62mm, special ball, M118, long range | 21 | 21 | 42 |
| M2010 | A191 | CTG, .300 cal, win mag, match | 21 | 21 | 42 |
| M107 | A552 | CTG, .50 cal, ball, M2/M33 | 21 | 21 | 42 |

Legend: cal – caliber, CTG – cartridge, DODIC – Department of Defense identification code, mm – millimeter

G-70. Units determine the best ammunition breakdown per magazine based on the weapon systems firing. Units should consider consolidating sniper weapon system magazines to increase throughput potential on the range facility.

RANGE FACILITIES

G-71. Table G-45 shows the Army-standard range facilities specifically designed to support sniper weapon system, Table V, Practice. Units must refer to their installation’s range operations SOPs or local training regulation to identify the weapon specific range facilities. Units use their RFMSS system for all scheduling.

Table G-45. Sniper Weapon System, Table V, Practice, authorized range facilities

| <i>Sniper Weapon Systems Range Facility Matrix</i> | | | | | | | |
|--|--------------------------------|------------|------------|-----------|-------------|------------|------------------|
| <i>Weapon</i> | <i>Standard Range Facility</i> | | | | | | |
| | <i>Zero</i> | <i>SFF</i> | <i>HSR</i> | <i>KD</i> | <i>MPMG</i> | <i>QTR</i> | <i>MAN Range</i> |
| M110 M110E1 | N/A | P | | A | A | A | A |
| M2010 | N/A | P | | A | A | A | A |
| M107 | N/A | | P | A | A | A | A |

Note.
For installations that do not have facilities with the multistory, multi-environment structure or the trackless moving targets, they must use the modified courses of fire (known as MCOF).
For units that must use the MPMG or QTR for sniper training, they must use the MCOF.

Legend: A – alternate authorized facility, HSR – heavy sniper range, KD – known distance range, MPMG – multipurpose machine gun range, MAN Range – maneuver range facility, N/A – not authorized, P – primary, SFF – automated sniper field fire range, QTR – qualification training range, Zero – basic 10 meter / 25 meter firing range (zero)

G-72. Figure G-5 shows the firing positions in the multistory, multi-environment used during this course of firing platform. Units that do not have access to a primary facility with the multistory, multi-environment (known as MSME) firing platform use the firing position provided on the primary range facility. When required to displace to the next firing position, the tower operator must announce to which lane the sniper team should advance.

Multistory, Multi-Environment Firing Platform

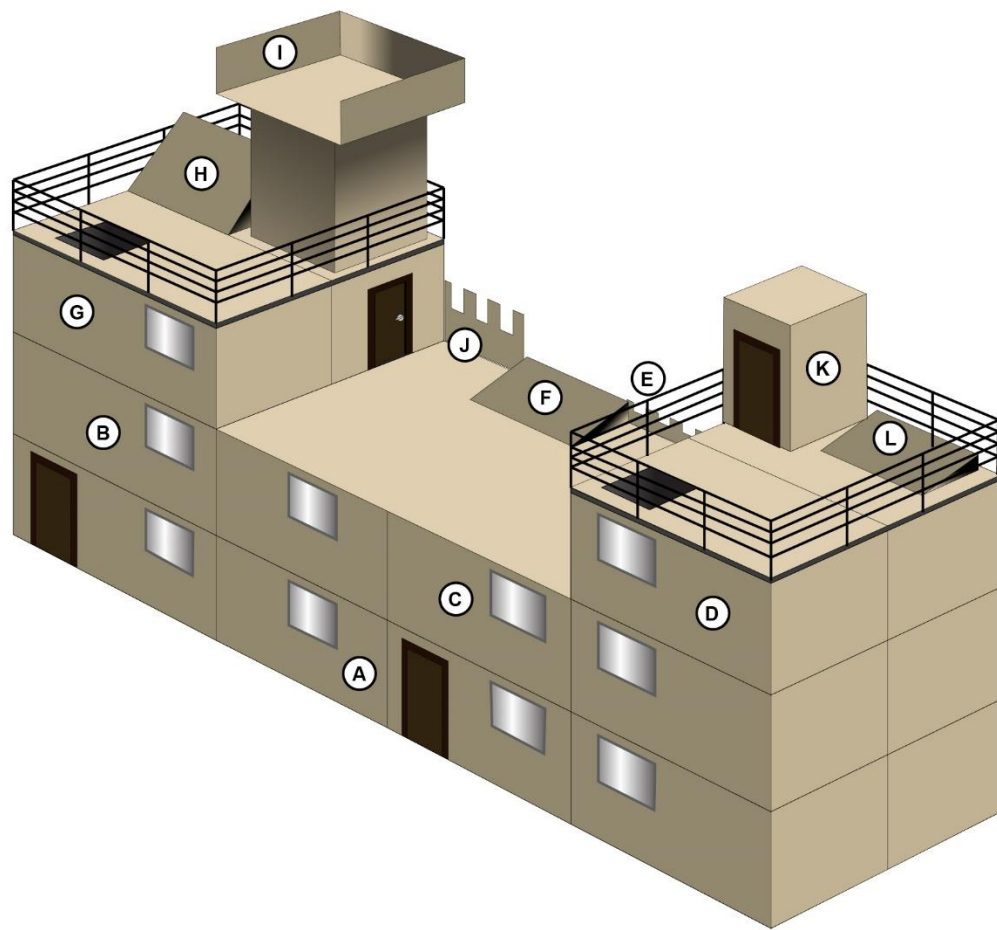

Not to scale. Pitched roofs and parapets not shown for clarity.

| Item | Firing Position Capability | Item | Firing Position Capability |
|------|----------------------------------|------|--|
| A | Reconfigurable Bay | G | Bright Room |
| B | North American or European Room | H | 12:12 Pitch Roof, Reverse Slope |
| C | Southwest Asia or African Room | I | Medium Parapet Wall, 30-inches tall |
| D | Blacked-out Room | J | High Parapet Wall, 44-inches tall |
| E | Low Parapet Wall, 11-inches tall | K | Confined Space, Small, 6 feet x 6 feet |
| F | 6:12 Pitch Roof, Reverse | L | 3:12 Pitch Roof, Reverse Slope |

Figure G-5. Multistory, multi-environment firing platform established firing positions example

TARGETRY

G-73. Table V requires silhouette targetry, either E-type, F-type, or D-type targets on the range. The leader must confirm the type and capability of the range’s targetry, lifting mechanisms, and simulators, and identify any unit requirements. During the preparation phase, leaders should be familiar with the targetry used and the sequence of the firing events. Figure G-6 shows the authorized targetry used during Table V.

| Sniper Weapons Targetry Requirements | |
|--|--|
| <p>A-8, target zero M4- / M16-series weapons 25-meters zero. Short range and pistol marksmanship target.</p> <p>8 ½ inches x 11 inches</p> <p>NSN 6920-01-660-9191</p> <p>Note: Recommended for cold bore shot at 200 meters. Outer 8-inch ring = 4 MOA. Units may select any target to complete the cold bore shot at 200 meters.</p> | |
| <p>E-1, target, silhouette: plastic, polyethylene, kneeling</p> <p>NSN 6920-00-071-4780</p> <p>Note. When TMT-I movers are used, other similar targets may be used.</p> | |
| <p>D-1, target, 3-dimensional: plastic, mannequin, kneeling</p> <p>NSN 6920-01-164-9625</p> <p>Note. When TMT-I movers are used, other similar targets may be used.</p> | |
| <p>I-type, steel silhouette or 10-inch steel round.</p> <p>NSN: 6920-00-071-4780</p> <p>Note: May be locally manufactured or procured.</p> <p>Typically, steel targets are not authorized at less than 100 meters. Units must coordinate for steel targetry authorization.</p> | |
| <p>Legend: “ – inches, MOA – minute of angle, NSN – national stock number, TMT-I – trackless moving target–Infantry</p> | |

Figure G-6. Authorized target types

G-74. Figure G-7 shows the stationary frontal target options. Frontal targets are required for the M107 engagements. Leaders may replace any stationary, frontal target with any other stationary, frontal target listed. The kill plates for the engine compartment should be large enough to account for 3 MOAs at distance.



| Sniper Weapons, Stationary Frontal Targetry | |
|--|--|
| <p>L2T-FRT, Light armor, technical truck, threat, frontal Plywood with thermal blankets</p> <p>Locally manufactured (see Training Circular [TC] 25-8)</p> |  |
| <p>L2T-FRT-C, Light armor, technical truck, threat, frontal, vehicle combat identification (VCID) with integrated thermalization.</p> <p>Note. Not all installations have the VCID targets. Units must coordinate with their supporting installation's range operations.</p> |  |
| <p>L3T-FRT, Light armor, sedan, threat, frontal Plywood with thermal blanket</p> <p>Locally manufactured (see TC 25-8)</p> |  |
| <p>Note. Thermal blankets are applied to the targets as depicted above or in TC 25-8. The unit applies the metal strike plates as required: driver and engine block. The sniper must strike the portion of the target identified in the tower script or prompt.</p> | |

Figure G-7. Authorized targets, frontal types

G-75. Figure G-8 shows the stationary and moving flank target options. Flank targets are required for the M107 engagements. Leaders may replace any flank target with any other flank target listed. The kill plates for the engine compartment should be large enough to account for 3 MOAs at distance.

| Sniper Weapons, Stationary Flank Targetry | |
|--|--|
| <p>L2T-FLK, Light armor, technical truck, threat, flank Plywood with thermal blankets</p> <p>Locally manufactured (see Training Circular [TC] 25-8)</p> | |
| <p>L2T-FLK-C, Light armor, technical truck, threat, flank, vehicle combat identification (VCID) with integrated thermalization.</p> <p>Note. Not all installations have the VCID targets. Units must coordinate with their supporting installation's range operations.</p> | |
| <p>L3T-FLK, Light armor, sedan, threat, flank Plywood with thermal blanket</p> <p>Locally manufactured (see TC 25-8)</p> | |
| <p>Note. Thermal blankets are applied to the targets as depicted above or in TC 25-8.</p> <p>The unit applies the metal strike plates as required: driver and engine block.</p> <p>The sniper must strike the portion of the target identified in the tower script or prompt.</p> | |

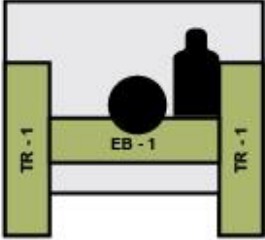
Figure G-8. Authorized targets, flank types

AUTHORIZED MODIFICATIONS

G-76. In the event the installation does not have the primary structures, instrumentation, or target lifting mechanisms, the unit is authorized to modify the course of fire. Table G-46 provides the authorized list of modifications the unit can apply to the course of fire. Units should provide feedback to their installation when modifications to the course of fire are required to highlight training gaps on their installation as appropriate.

Table G-46. Authorized modifications to the course of fire

| <i>Sniper Range Facility Authorized Modifications to the Course of Fire</i> | | | |
|--|--|--|---|
| <i>Structure, Instrumentation, or Targetry</i> | <i>Authorized Modification</i> | <i>Alternate Modification</i> | <i>Remarks</i> |
| Multistory, multi-environment firing platform | Eight separate, ground-based firing positions. | Use multipurpose maneuver range with air-ground integration villages. | The purpose is to provide the sniper team challenging firing positions that require critical thinking to overcome firing position conditions. |
| Trackless moving targets—Infantry (TMT-I) | Standard moving Infantry targets (MITs) at the appropriate distance. | Use standard iron maiden targets at the appropriate distance when no MIT is available. | Ensure the targetry is programmed according to the target's posture: moving or evasive. |
| Trackless moving targets—vehicle (TMT-V) | Standard moving Armor target (MAT) at the appropriate distance. | Standard stationary Armor target (SAT) at the appropriate distance. | Ensure the targetry is programmed according to the target's posture: moving or evasive. |
| Engine or driver kill zones | Cut out appropriate areas on the target and apply steel hit plates for down-range feedback | | |
| <p>Note. For units conducting the training in austere environments, or with international partners, the most stringent range safety regulations, policies, and requirements are followed.</p> <p>Any use of steel hit plates or similar items requires approval from the supporting installation's range safety office.</p> | | | |

SNIPER WEAPON SYSTEMS, TABLE V, STAGE 1, DAY FIRE

G-77. Table V consists of two separate stages in the course of fire. The stages used during Table V are—

- Stage 1 – Day Fire.
- Stage 2 – Night Fire, Assisted (pointer, illuminator, and thermal).

G-78. Soldiers must complete both course of fire stages successfully. The following section describes the course of fire for Table V, Stage 1, Day Fire.

SCENARIO ENGAGEMENTS

G-79. Targets are presented to the sniper in single target arrays. Targets are presented such that 90-percent of the target is clearly visible to the sniper from the expected or planned firing position. Targets are exposed to the sniper based on the target's tactical posture presented during the engagement as follows:

- Stationary target engagements are exposed for 20 seconds.
- Moving target engagements are exposed for 25 seconds.
- Evasive target engagements are exposed for 30 seconds.

G-80. The sniper and spotter have two minutes to establish their firing position and report SET to the sniper team leader after each engagement. During the transition period to the next engagement or firing position, the sniper and spotter are responsible to reload as appropriate, update their sketch card, and establish the best prone supported firing position overlooking the directed target area. Tables G-47 through G-49, on pages G-52 through G-54 show the scenario engagement sequence for Table V.

Table G-47. M110 sniper rifle, Table V, Practice, Stage 1, Day Fire, engagement sequence

| <i>M110 Sniper Weapon System Engagements, Stage 1, Day Fire</i> | | | | | | | |
|---|---|-----------|---------------|-----------------------|--------------|---------------|-----------------------------|
| <i>ENG</i> | <i>Task or Capability</i> | <i>FP</i> | <i>Target</i> | <i>Target Posture</i> | <i>M110</i> | <i>Rounds</i> | <i>Target Exposure Time</i> |
| 0 | Sketch card and cold bore | A | A-8 | STA | 200m | 1 | 10 minutes |
| 1 | Reconfigurable, known distance | A | E-type | STA | 500m | 2 | 20 seconds |
| 2 | Reconfigurable, known distance | A | E-type | STA | 800m | 2 | 20 seconds |
| 3 | North America or Europe, known distance | B | E-type | STA | 600m | 2 | 20 seconds |
| 4 | SWA or African, unknown distance | C | TMT-I | STA | 400m to 600m | 2 | 20 seconds |
| 5 | Blacked-out room, unknown distance | D | TMT-I | MOV | 400m to 600m | 2 | 25 seconds |
| 6 | Low parapet, unknown distance | E | TMT-I | MOV | 500m to 700m | 2 | 25 seconds |
| 7 | 6:12 pitch, unknown distance | E | TMT-I | MOV | 600m to 800m | 2 | 25 seconds |
| 8 | Bright room, unknown distance | F | TMT-I | MOV | 300m to 500m | 2 | 25 seconds |
| 9 | 12:12 pitch, unknown distance | G | TMT-I | EVA | 400m to 600m | 2 | 30 seconds |
| 10 | Parapet, unknown distance | G | TMT-I | EVA | 600m to 800m | 2 | 30 seconds |
| <p>Note. This course of fire is based on the capabilities of the automated sniper field fire (SFF) range or comparable facility. If the primary facility is not available, the unit should refer to the modified course of fire (known as MCOF).</p> | | | | | | | |
| <p>Legend: ENG – engagement, EVA – evasive target, FP – firing point, m – meter, MOV – moving target, SWA – Southwest Asia, STA – stationary target, TMT-I – trackless moving targets-Infantry</p> | | | | | | | |

Table G-48. M2010 sniper rifle, Table V, Practice, Stage 1, Day Fire, engagement sequence

| <i>M2010 Sniper Weapon System Engagements, Stage 1, Day Fire</i> | | | | | | | |
|---|---|-----------|---------------|-----------------------|---------------|---------------|-----------------------------|
| <i>ENG</i> | <i>Task or Capability</i> | <i>FP</i> | <i>Target</i> | <i>Target Posture</i> | <i>M2010</i> | <i>Rounds</i> | <i>Target Exposure Time</i> |
| 0 | Sketch card and cold bore | A | A-8 | STA | 200m | 1 | 10 minutes |
| 1 | Reconfigurable, known distance | A | E-type | STA | 500m | 2 | 20 seconds |
| 2 | Reconfigurable, known distance | A | E-type | STA | 800m | 2 | 20 seconds |
| 3 | North America or Europe, known distance | B | E-type | STA | 600m | 2 | 20 seconds |
| 4 | SWA or African, unknown distance | C | TMT-I | STA | 400m to 600m | 2 | 20 seconds |
| 5 | Blacked-out room, unknown distance | D | TMT-I | MOV | 400m to 600m | 2 | 25 seconds |
| 6 | Low parapet, unknown distance | E | TMT-I | MOV | 500m to 700m | 2 | 25 seconds |
| 7 | 6:12 pitch, unknown distance | E | TMT-I | MOV | 600m to 800m | 2 | 25 seconds |
| 8 | Bright room, unknown distance | F | TMT-I | MOV | 300m to 500m | 2 | 25 seconds |
| 9 | 12:12 pitch, unknown distance | G | TMT-I | EVA | 800m to 1000m | 2 | 30 seconds |
| 10 | Parapet, unknown distance | G | TMT-I | EVA | 800m to 1000m | 2 | 30 seconds |
| <p>Note. This course of fire is based on the capabilities of the automated sniper field fire (SFF) range or comparable facility. If the primary facility is not available, the unit should refer to the modified course of fire (known as MCOF).</p> <p>Legend: ENG – engagement, EVA – evasive target, FP – firing point, m – meter, MOV – moving target, SWA – Southwest Asia, STA – stationary target, TMT-I – trackless moving targets-Infantry</p> | | | | | | | |

Table G-49. M107 sniper rifle, Table V, Practice, Stage 1, Day Fire, engagement sequence

| <i>M107 Sniper Weapon System Engagements, Stage 1, Day Fire</i> | | | | | | | |
|--|---|-----------|----------------------------|-----------------------|----------------------|---------------|-----------------------------|
| <i>ENG</i> | <i>Task or Capability</i> | <i>FP</i> | <i>Target</i> | <i>Target Posture</i> | <i>M2010</i> | <i>Rounds</i> | <i>Target Exposure Time</i> |
| 0 | Sketch card and cold bore | A | A-8 | STA | 200m | 1 | 10 minutes |
| 1 | Reconfigurable, known distance | A | E-type | STA | 600m | 2 | 20 seconds |
| 2 | Reconfigurable, known distance | A | E-type | STA | 400m | 2 | 20 seconds |
| 3 | North America or Europe, known distance | B | L3T-FRT TMT-V Driver | STA | 900m | 2 | 20 seconds |
| 4 | SWA or African, unknown distance | C | L2T-FRT TMT-V Engine | STA | 600m to 800m | 2 | 20 seconds |
| 5 | Blacked-out room, unknown distance | D | L2T-FLK TMT-V Driver | MOV | 1200m to 1300m | 2 | 25 seconds |
| 6 | Low parapet, unknown distance | E | L3T-FLK TMT-V Driver | MOV | 1400m to 1600m | 2 | 25 seconds |
| 7 | 6:12 pitch, unknown distance | E | L2T-FLK TMT-V Driver | MOV | 1200m to 1300m | 2 | 25 seconds |
| 8 | Bright room, unknown distance | F | L3T-FLK TMT-V Engine | MOV | 1400m to 1600m | 2 | 25 seconds |
| 9 | 12:12 pitch, unknown distance | G | L2T-FLK TMT-V Engine | EVA | 1200m to 1400m | 2 | 30 seconds |
| 10 | Parapet, unknown distance | G | L3T-FLK TMT-V Driver | EVA | 1400m to 1600m | 2 | 30 seconds |
| <p>Note. This course of fire is based on the capabilities of the heavy sniper range (HSR) range or comparable facility. If the primary facility is not available, the unit should refer to the modified course of fire (known as MCOF).</p> <p>Legend: ENG – engagement, EVA – evasive target, FP – firing point, m – meter, MOV – moving target, SWA – Southwest Asia STA – stationary target, TMT-V – trackless moving targets-vehicle</p> | | | | | | | |

G-81. Table G-50 provides the Table V, Practice, Stage 1, Day Fire, throughput schedule. Units use table G-50 as a guide. Table G-50 portrays the overall efficiency of the range facility when conducting the training event.

Table G-50. Sniper rifle, Table V, Practice, Stage 1, Day Fire throughput time schedule

| <i>Phase</i> | <i>Time to Execute</i> | <i>Remarks</i> | |
|---|----------------------------------|--|--|
| Stationary Targets | 11:20 minutes | Sketch card and cold bore are conducted as the sniper team awaits the Tower instructions to the first firing point. Does not include administrative time to exit or enter the sniper teams to their designated start position. | |
| Moving Targets | 5:40 minutes | | |
| Evasive Targets | 5:00 minutes | | |
| Total Time Per Firing Order | 22:00 minutes | | |
| <i>Firing Orders</i> | Simultaneous Sniper Teams | | |
| | 1 Sniper Team | 2 Sniper Teams | 3 Sniper Teams |
| 2 | 44 min | 4 | 6 |
| 3 | 1 hr 6 min | 6 | 9 |
| 4 | 1 hr 28 min | 8 | 12 |
| 5 | 1 hr 50 min | 10 | 15 |
| 6 | 2 hrs 12 min | 12 | 18 |
| 7 | 2 hrs 34 min | 14 | 21 |
| 8 | 2 hrs 56 min | 16 | 24 |
| 9 | 3 hrs 18 min | 18 | 27 |
| 10 | 3 hrs 40 min | 20 | 30 (ABCT) |
| 11 | 4 hrs 2 min | 22 | 33 |
| 12 | 4 hrs 24 min | 24 | 36 |
| 13 | 4 hrs 46 min | 26 | 39 (IBCT) |
| 14 | 5 hrs 8 min | 28 | 42 |
| 15 | 5 hrs 30 min | 30 (ABCT) | 45 |
| 16 | 5 hrs 52 min | 32 | 48 (SBCT) |
| 17 | 6 hrs 14 min | 34 | Snipers per BCT Type: ABCT = 30 IBCT = 37 SBCT = 48 |
| 18 | 6 hrs 36 min | 36 | |
| 19 | 6 hrs 58 min | 38 (IBCT) | |
| 20 | 7 hrs 20 min | 40 | |
| 21 | 7 hrs 42 min | 42 | |
| 22 | 8 hrs 4 min | 44 | |
| 23 | 8 hrs 26 min | 46 | |
| 24 | 8 hrs 48 min | 48 (SBCT) | |
| Legend: ABCT – Armor brigade combat team, BCT- brigade combat team, hrs – hours, IBCT – Infantry brigade combat team, min – minute, SBCT – Stryker brigade combat team | | | |

CONDUCT OF THE RANGE

G-82. Leaders instruct snipers on the objectives of Table V and the importance of the functional elements of the shot process. Table V, Stage 1, Day Fire, contains 11 firing tasks with an administrative pause programmed at the end of each engagement to facilitate changing firing positions.

G-83. Snipers enter the range and move to their firing points. Once at the firing point, firers assume a prone supported firing position with weapons in a green status. Firers fire Table V tasks from the READY at varying firing positions throughout the course of fire. The sniper teams conduct the course of fire such that—

- Task 0, sketch card and cold bore shot, is completed prior to conducting the scored engagements.
- All engagements in the scored events are fired from positions established by the sniper using available equipment, attachments, or surrounding items.
- First round hits receive 10 points.
- Second round hits receive 5 points.
- No points are awarded for hits beyond the second round or for targets not hit.

G-84. Firers must score a minimum of 140 of 200 points (70 percent) on the 10 engagements presented to successfully pass this event with a minimum of 70 points in stage 1 and 70 points in stage 2. It is not required for Soldiers to successfully complete this table before conducting Table VI. This event is purposefully more rigorous than the qualification event. The targets are presented in a rapid tempo, and the time to transition between firing positions and tactical reloading are reduced. Leaders annotate the official record of training on DA Form 7811.

G-85. Snipers begin Table V by moving into the firing position with the use of administrative commands from the tower operator. Tower operators use administrative commands to control the flow of the range, movement of personnel, and other command and control purposes. Table G-51 provides an example of the administrative commands for moving a new firing order into position.

Table G-51. Table V, new firing order, conduct of the range example

| <i>New Firing Order, Conduct of the Range</i> | | | |
|--|---|---|-----------------------|
| | Task | Target | Target Type |
| SKETCH CARD AND COLD BORE SHOT PREPARATION | New Firing Order | N/A | N/A |
| | Rounds per Target | DODIC | Time (Seconds) |
| | N/A | AA11 (M110) A191 (M2010) A552 (M107) | NO LIMIT |
| TOWER | | SOLDIER ACTION | |
| CONDUCT OF THE RANGE | SECURE YOUR AMMUNITION AND MOVE TO YOUR FIRING POINT | Snipers secure their weapon in a GREEN status, their training ammunition and move to the designated firing point. | |
| Once all snipers and spotters are complete, conduct of the range continues. | | | |
| Legend: DODIC – Department of Defense identification code, N/A – not applicable | | | |

G-86. Once the snipers are in the initial fighting position, they complete their sketch card and engagement 0. Next, they conduct a cold bore shot through coordination with the tower operator. This firing position should be separated from those snipers negotiating the course of fire with all shots controlled and authorized by the tower operator. Table G-52 is the tower script.

Table G-52. Table V, engagement 0, cold bore, conduct of fire example

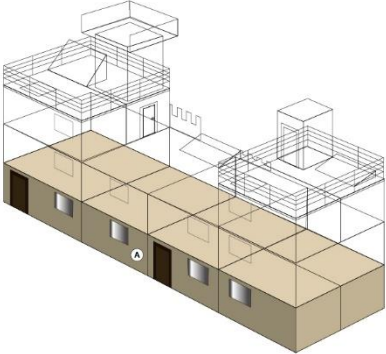
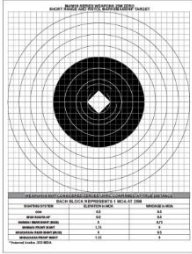
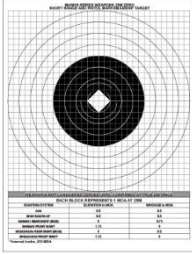
| <i>Table V, Engagement 0 – Cold Bore</i> | | |
|--|---|--|
| Firing Position | M110 / M2010 Target | M107 Target |
|  |  |  |
| | 200 meters | 200 meters |
| Element | Tower Prompt | Remarks |
| WEAPONS SAFETY STATUS RED | GO TO PRONE MAKE READY | Sniper moves to the PRONE supported position, establishes a good firing position, and loads the appropriate ammunition. |
| ALERT | SIERRA TANGO (ONE) | |
| TARGET DESCRIPTION | COLD BORE | |
| DIRECTION | TRP _____ | |
| RANGE | TWO-HUNDRED | |
| CONTROL | ONE ROUND | |
| | WEAPONS FREE WEAPONS FREE | |
| EXECUTION | ENGAGE UPON POSITIVE IDENTIFICATION | Sniper is free to engage. |
| TERMINATION | CEASE FIRE CEASE FIRE | |
| WEAPONS SAFETY STATUS RED | | |
| ONCE COMPLETE, SNIPERS REPORT SET AND AWAIT INSTRUCTIONS FROM THE TOWER. | | |
| Legend: DODIC – Department of Defense identification code, TRP – target reference point | | |

G-87. The following engagement sequence guide initiates the Table V scenario. Tables G-53 through G-62, on pages G-59 through G-67, are the engagement sequences with a generic conduct of fire process for the tower operator.

Table G-53. Sniper weapons, Table V, Stage 1, Day Fire, engagement 1, conduct of fire example



| <i>Table V, Engagement 1 – Reconfigurable, Known Distance</i> | | |
|--|---|---|
| Firing Position | M110 / M2010 Target | M107 Target |
|  |  |  |
| | 500 meters | 600 meters |
| Element | Tower Prompt | Remarks |
| WEAPON SAFETY STATUS (UNIT MAY HAVE PLACED SNIPERS IN A GREEN STATUS AWAITING THEIR FIRING ORDER) | | |
| ALERT | SIERRA TANGO (ONE) | |
| TARGET DESCRIPTION | TROOP | |
| DIRECTION | TRP _____ | |
| CONTROL | TWO ROUNDS WEAPONS FREE WEAPONS FREE | |
| EXECUTION | ENGAGE UPON POSITIVE IDENTIFICATION | Sniper is free to engage. |
| TERMINATION | CEASE FIRE CEASE FIRE | |
| WEAPONS SAFETY STATUS RED | | |
| SNIPERS AWAIT COMMANDS FROM THE TOWER TO CONTINUE IN A RED STATUS. | | |
| SNIPERS ARE PROVIDED NO MORE THAN 2 MINUTES BETWEEN ENGAGEMENTS. | | |
| Legend: DODIC – Department of Defense identification code, TRP - target reference point | | |

Table G-54. Sniper weapons, Table V, Stage 1, Day Fire, engagement 2, conduct of fire example

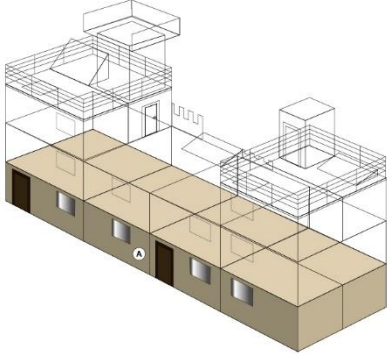

| <i>Table V, Engagement 2 – Reconfigurable, Known Distance</i> | | |
|--|---|---|
| Firing Position | M110 / M2010 Target | M107 Target |
|  |  |  |
| | 800 meters | 400 meters |
| Element | Tower Prompt | Remarks |
| WEAPONS SAFETY STATUS RED | | |
| ALERT | SIERRA TANGO (ONE) | |
| TARGET DESCRIPTION | HIGH VALUE TARGET | |
| DIRECTION | TRP _____ | |
| CONTROL | TWO ROUNDS WEAPONS FREE WEAPONS FREE | |
| EXECUTION | ENGAGE UPON POSITIVE IDENTIFICATION | Sniper is free to engage. |
| TERMINATION | CEASE FIRE CEASE FIRE | |
| WEAPONS SAFETY STATUS RED | | |
| UPON COMPLETION OF THE ENGAGEMENT, THE TOWER DIRECTS THE SNIPER TEAM TO FIRING POSITION B – NORTH AMERICAN OR EUROPEAN ROOM AND REPORT SET. | | |
| SNIPER TEAMS HAVE 2 MINUTES FROM ACKNOWLEDGING TO REPORT SET IN FIRING POSITION B | | |
| Legend: DODIC – Department of Defense identification code, TRP - target reference point | | |

Table G-55. Sniper weapons, Table V, Stage 1, Day Fire, engagement 3, conduct of fire example

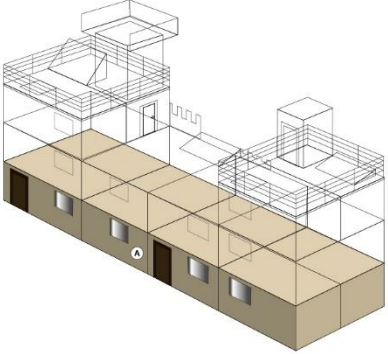

| <i>Table V, Engagement 3 – North American / European, Known Distance</i> | | |
|--|---|---|
| Firing Position | M110 / M2010 Target | M107 Target |
|  |  |  |
| | 600 meters | 900 meters |
| Element | Tower Prompt | Remarks |
| WEAPONS SAFETY STATUS RED | | |
| ALERT | SIERRA TANGO (ONE) | |
| TARGET DESCRIPTION | INSURGENT / DRIVER | |
| DIRECTION | TRP _____ | |
| CONTROL | TWO ROUNDS WEAPONS FREE WEAPONS FREE | |
| EXECUTION | ENGAGE UPON POSITIVE IDENTIFICATION | Sniper is free to engage. |
| TERMINATION | CEASE FIRE CEASE FIRE | |
| WEAPONS SAFETY STATUS RED | | |
| UPON COMPLETION OF THE ENGAGEMENT, THE TOWER DIRECTS THE SNIPER TEAM TO: FIRING POSITION C – SOUTHWEST ASIA OR AFRICAN ROOM AND REPORT SET. | | |
| SNIPER TEAMS HAVE 2 MINUTES FROM ACKNOWLEDGING TO REPORT SET IN FIRING POSITION C | | |
| Legend: DODIC – Department of Defense identification code, TRP - target reference point | | |

Table G-56. Sniper weapons, Table V, Stage 1, Day Fire, engagement 4, conduct of fire example

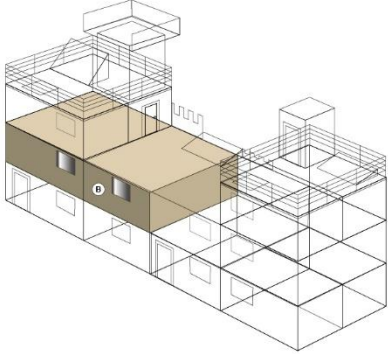

| <i>Table V, Engagement 4 – Southwest Asia / Africa, Unknown Distance</i> | | |
|---|--|---|
| Firing Position | M110 / M2010 Target | M107 Target |
|  |  TMT-I, STATIONARY 400 to 600 meters |  ENGINE 600 to 800 meters |
| Element | Tower Prompt | Remarks |
| WEAPON SAFETY STATUS RED | | |
| ALERT | SIERRA TANGO (ONE) | |
| TARGET DESCRIPTION | INSURGENT / FLEEING INSURGENT | |
| DIRECTION | TRP _____ | |
| CONTROL | TWO ROUNDS (IMMOBILIZE THE VEHICLE) | |
| | WEAPONS FREE WEAPONS FREE | |
| EXECUTION | ENGAGE UPON POSITIVE IDENTIFICATION | Sniper is free to engage. |
| TERMINATION | CEASE FIRE CEASE FIRE | |
| WEAPONS SAFETY STATUS RED | | |
| UPON COMPLETION OF THE ENGAGEMENT, THE TOWER DIRECTS THE SNIPER TEAM TO: FIRING POSITION D – BLACKOUT ROOM AND REPORT SET. | | |
| SNIPER TEAMS HAVE 2 MINUTES FROM ACKNOWLEDGING TO REPORT SET IN FIRING POSITION D. | | |
| Legend: DODIC – Department of Defense identification code, TMT-I – trackless moving targets-Infantry, TRP - target reference point | | |

Table G-57. Sniper weapons, Table V, Stage 1, Day Fire, engagement 5, conduct of fire example

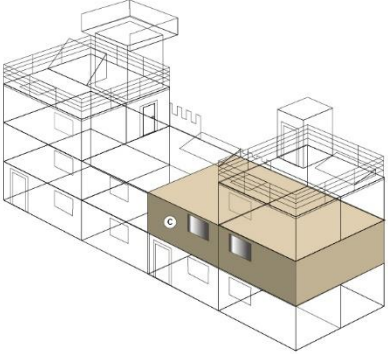

| <i>Table V, Engagement 5 – Blacked-Out Room, Unknown Distance</i> | | |
|---|--|--|
| Firing Position | M110 / M2010 Target | M107 Target |
|  |  TMT-I, MOVING 400 to 600 meters |  TMT-V, MOVING, DRIVER 1200 to 1300 meters |
| Element | Tower Prompt | Remarks |
| WEAPONS SAFETY STATUS RED | | |
| ALERT | SIERRA TANGO (ONE) | |
| TARGET DESCRIPTION | FLEEING INSURGENT (DRIVER) | |
| DIRECTION | TRP _____ | |
| CONTROL | TWO ROUNDS | |
| | WEAPONS FREE | |
| | WEAPONS FREE | |
| EXECUTION | ENGAGE UPON POSITIVE IDENTIFICATION | Sniper is free to engage. |
| TERMINATION | CEASE FIRE CEASE FIRE | |
| WEAPONS SAFETY STATUS RED | | |
| UPON COMPLETION OF THE ENGAGEMENT, THE TOWER DIRECTS THE SNIPER TEAM TO: FIRING POSITION E – LOW PARAPET AND REPORT SET. | | |
| SNIPER TEAMS HAVE 2 MINUTES FROM ACKNOWLEDGING TO REPORT SET IN FIRING POSITION E. | | |
| Legend: DODIC – Department of Defense identification code, TMT-I – trackless moving targets-Infantry, TMT-V – trackless moving targets-vehicle, TRP - target reference point | | |

Table G-58. Sniper weapons, Table V, Stage 1, Day Fire, engagement 6, conduct of fire example

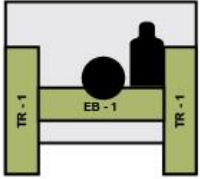

| <i>Table V, Engagement 6 – Low Parapet, Unknown Distance</i> | | |
|---|--|--|
| Firing Position | M110 / M2010 Target | M107 Target |
|  |  TMT-I, MOVING 500 to 700 meters |  TMT-V, MOVING, DRIVER 1400 to 1600 meters |
| Element | Tower Prompt | Remarks |
| WEAPON SAFETY STATUS RED | | |
| ALERT | SIERRA TANGO (ONE) | |
| TARGET DESCRIPTION | INBOUND HIGH VALUE TARGET (DRIVER) | |
| DIRECTION | TRP _____ | |
| CONTROL | TWO ROUNDS WEAPONS FREE WEAPONS FREE | |
| EXECUTION | ENGAGE UPON POSITIVE IDENTIFICATION | Sniper is free to engage. |
| TERMINATION | CEASE FIRE CEASE FIRE | |
| WEAPONS SAFETY STATUS RED | | |
| UPON COMPLETION OF THE ENGAGEMENT, THE TOWER DIRECTS THE SNIPER TEAM TO: FIRING POSITION E – 6:12 PITCH ROOF AND REPORT SET. | | |
| SNIPER TEAMS HAVE 2 MINUTES FROM ACKNOWLEDGING TO REPORT SET IN FIRING POSITION E. | | |
| Legend: DODIC – Department of Defense identification code, TMT-I – trackless moving targets-Infantry, TMT-V – trackless moving targets-vehicle, TRP - target reference point | | |

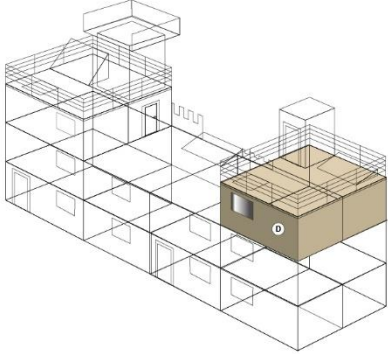
Table G-59. Sniper weapons, Table V, Stage 1, Day Fire, engagement 7, conduct of fire example

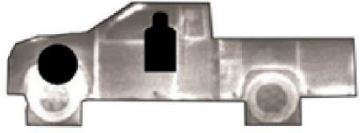

| <i>Table V, Engagement 7 – 6:12 Pitch Roof, Unknown Distance</i> | | |
|---|--|--|
| Firing Position | M110 / M2010 Target | M107 Target |
|  |  TMT-I, MOVING 600 to 800 meters |  TMT-V, MOVING, DRIVER 1200 to 1300 meters |
| Element | Tower Prompt | Remarks |
| WEAPON SAFETY STATUS RED | | |
| ALERT | SIERRA TANGO (ONE) | |
| TARGET DESCRIPTION | MOVING TROOP (DRIVER) | |
| DIRECTION | TRP ____ | |
| CONTROL | TWO ROUNDS WEAPONS FREE WEAPONS FREE | |
| EXECUTION | ENGAGE UPON POSITIVE IDENTIFICATION | Sniper is free to engage. |
| TERMINATION | CEASE FIRE CEASE FIRE | |
| WEAPONS SAFETY STATUS RED | | |
| UPON COMPLETION OF THE ENGAGEMENT, THE TOWER DIRECTS THE SNIPER TEAM TO: FIRING POSITION F – BRIGHT ROOM AND REPORT SET. | | |
| SNIPER TEAMS HAVE 2 MINUTES FROM ACKNOWLEDGING TO REPORT SET IN FIRING POSITION F. | | |
| Legend: DODIC – Department of Defense identification code, TMT-I – trackless moving targets-Infantry, TMT-V – trackless moving targets-vehicle, TRP - target reference point | | |

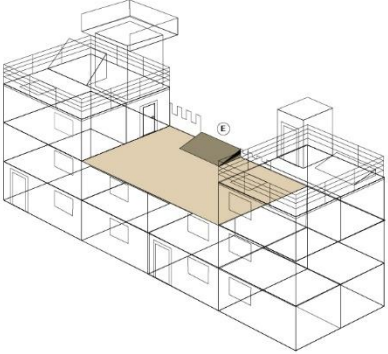
Table G-60. Sniper weapons, Table V, Stage 1, Day Fire, engagement 8, conduct of fire example

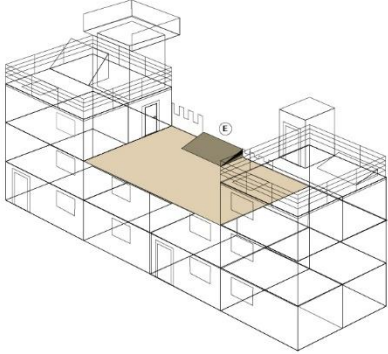

| <i>Table V, Engagement 8 – Bright Room, Unknown Distance</i> | | |
|---|--|--|
| Firing Position | M110 / M2010 Target | M107 Target |
|  |  TMT-I, MOVING 300 to 500 meters |  TMT-V, MOVING, ENGINE 1400 to 1600 meters |
| Element | Tower Prompt | Remarks |
| WEAPON SAFETY STATUS RED | | |
| ALERT | SIERRA TANGO (ONE) | |
| TARGET DESCRIPTION | FLEEING HIGH VALUE TARGET | |
| DIRECTION | TRP _____ | |
| CONTROL | TWO ROUNDS (IMMOBILIZE VEHICLE) | |
| | WEAPONS FREE WEAPONS FREE | |
| EXECUTION | ENGAGE UPON POSITIVE IDENTIFICATION | Sniper is free to engage. |
| TERMINATION | CEASE FIRE CEASE FIRE | |
| WEAPONS SAFETY STATUS RED | | |
| UPON COMPLETION OF THE ENGAGEMENT, THE TOWER DIRECTS THE SNIPER TEAM TO: FIRING POSITION G – 12:12 PITCH ROOF AND REPORT SET. | | |
| SNIPER TEAMS HAVE 2 MINUTES FROM ACKNOWLEDGING TO REPORT SET IN FIRING POSITION G. | | |
| Legend: DODIC – Department of Defense identification code, TMT-I – trackless moving targets-Infantry, TMT-V – trackless moving targets-vehicle, TRP - target reference point | | |

Table G-61. Sniper weapons, Table V, Stage 1, Day Fire, engagement 9, conduct of fire example

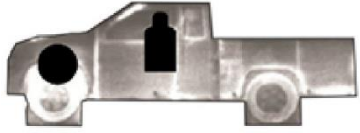

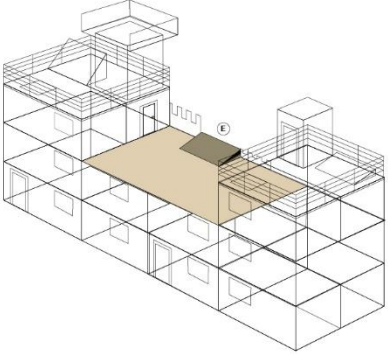

| <i>Table V, Engagement 9 – 12:12 Pitch Roof, Unknown Distance</i> | | |
|---|--|--|
| Firing Position | M110 / M2010 Target | M107 Target |
|  |  TMT-I, EVASIVE |  TMT-V, EVASIVE, ENGINE |
| | 400 to 600 meters (M110) 800 to 1000 meters (M2010) | 1200 to 1400 meters |
| Element | Tower Prompt | Remarks |
| WEAPON SAFETY STATUS RED | | |
| ALERT | SIERRA TANGO (ONE) | |
| TARGET DESCRIPTION | INSURGENTS MOVING INTO SECTOR | |
| DIRECTION | TRP _____ | |
| CONTROL | TWO ROUNDS (IMMOBILIZE ENGINE) | |
| | WEAPONS FREE WEAPONS FREE | |
| EXECUTION | ENGAGE UPON POSITIVE IDENTIFICATION | Sniper is free to engage. |
| TERMINATION | CEASE FIRE CEASE FIRE | |
| WEAPONS SAFETY STATUS RED | | |
| UPON COMPLETION OF THE ENGAGEMENT, THE TOWER DIRECTS THE SNIPER TEAM TO: FIRING POSITION G – PARAPET AND REPORT SET. | | |
| SNIPER TEAMS HAVE 2 MINUTES FROM ACKNOWLEDGING TO REPORT SET IN FIRING POSITION G. | | |
| Legend: DODIC – Department of Defense identification code, TMT-I – trackless moving targets-Infantry, TMT-V – trackless moving targets-vehicle, TRP - target reference point | | |

Table G-62. Sniper weapons, Table V, Stage 1, Day Fire, engagement 10, conduct of fire example

| <i>Table V, Engagement 10 – Parapet, 30-inch, Unknown Distance</i> | | |
|---|--|---|
| Firing Position | M110 / M2010 Target | M107 Target |
|  |  TMT-I, EVASIVE 600 to 800 meters (M110) 800 to 1000 meters (M2010) |  TMT-V, EVASIVE, DRIVER 1400 to 1600 meters |
| Element | Tower Prompt | Remarks |
| WEAPON SAFETY STATUS | | |
| ALERT | SIERRA TANGO (ONE) | |
| TARGET DESCRIPTION | FLEEING INSURGENT (DRIVER) | |
| DIRECTION | TRP _____ | |
| CONTROL | TWO ROUNDS WEAPONS FREE WEAPONS FREE | |
| EXECUTION | ENGAGE UPON POSITIVE IDENTIFICATION | Sniper is free to engage. |
| TERMINATION | CEASE FIRE CEASE FIRE | |
| WEAPONS SAFETY STATUS RED | | |
| AT THE COMPLETION OF THIS ENGAGEMENT, TOWER REQUESTS A SITUATION REPORT WITH ROUNDS EXPENDED. | | |
| ONCE SNIPER TEAM REPORTS, TOWER CONTINUES. | | |
| Legend: DODIC – Department of Defense identification code, TMT-I – trackless moving targets-Infantry, TMT-V – trackless moving targets-vehicle, TRP - target reference point | | |

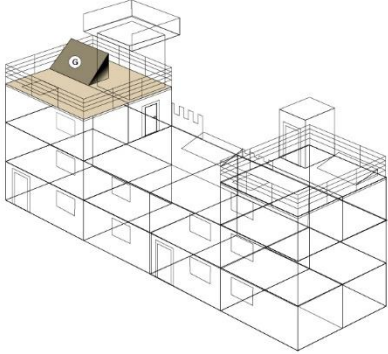
G-88. A lane safety clears the firers upon their completion of Table V and collecting their dunnage. A lane safety verifies the clearing prior to the Soldier moving from the firing point. Once the lane safety clears all the Soldiers, the lane safety communicates the WSS to the tower operator. The tower operator issues an administrative command to move the completed Soldiers off the range. Table G-63 is an example of this command.

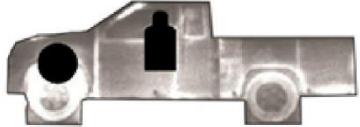
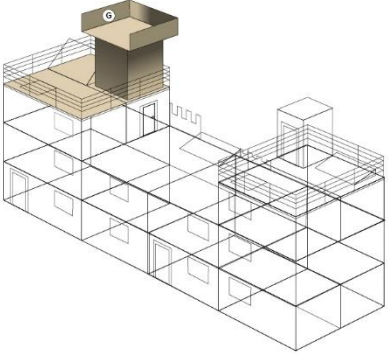
Table G-63. Table V, completed firing order, conduct of the range example

| <i>Firing Order Complete</i> | | | |
|--|--|--|----------------|
| FIRING ORDER COMPLETE | Task | Target | Target Type |
| | Completed Firing Order | N/A | N/A |
| | Rounds per Target | DODIC | Time (Seconds) |
| | N/A | N/A | NO LIMIT |
| TOWER | | SOLDIER ACTION | |
| WEAPON SAFETY STATUS RED | | | |
| WEAPONS SAFETY STATUS GREEN | GO GREEN GO GREEN ONCE VERIFIED BY THE RSO, SECURE WEAPON | Soldiers clear their weapon and wait to be inspected by a lane safety. | |
| CONDUCT OF THE RANGE | SNIPERS SECURE YOUR DUNNAGE MOVE TO THE BASELINE. | Firers secure weapon and ammunition dunnage and move to the designated location. | |
| Once all snipers return to the baseline, tower directs the firing order off the range. | | | |
| Legend: DODIC – Department of Defense identification code, N/A – not applicable, RSO – range safety officer | | | |

G-89. As soon as the lane safety clears the completed firing order, the tower operator moves a new firing order into position and the process repeats itself until all firers have completed Table V, Practice, successfully. Any identified firers that require retraining move to the appropriate concurrent training location.

SNIPER WEAPON SYSTEMS, TABLE V, STAGE 2, NIGHT FIRE, ASSISTED

G-90. Table V consists of two separate stages within the course of fire. The stages used during Table V are—

- Stage 1 – Day Fire.
- Stage 2 – Night Fire, Assisted (pointer, illuminator, and thermal).

G-91. Soldiers must finish both stages to successfully complete the course of fire. The following section describes the course of fire for Table V, Stage 2, Night Fire, Assisted.

SCENARIO ENGAGEMENTS

G-92. Targets are presented to the sniper in single target arrays. Targets are presented such that 90-percent of the target is clearly visible to the sniper from the expected or planned firing position. Targets are exposed to the sniper based on the target's tactical posture presented during the engagement as follows:

- Stationary target engagements are exposed for 30 seconds.
- Moving target engagements are exposed for 35 seconds.
- Evasive target engagements are exposed for 40 seconds.

G-93. The sniper and spotter have three minutes to establish their firing position and report SET to the sniper team leader after each engagement. During the transition period to the next engagement or firing position, the sniper and spotter are responsible to reload as appropriate, update their sketch card, and establish the best prone supported firing position overlooking the directed target area. Tables G-64 through G-66, on pages G-70 through G-71, show the scenario engagement sequence for Table V, Stage 2, Night Fire, Assisted.

Table G-64. M110 sniper rifle, Table V, Practice, Stage 2, Night Fire, assisted, engagement sequence

| <i>M110 Sniper Weapon System Engagements, Stage 2, Night Fire, Assisted</i> | | | | | | | |
|---|--|-----------|---------------|-----------------------|--------------|---------------|-----------------------------|
| <i>ENG</i> | <i>Task or Capability</i> | <i>FP</i> | <i>Target</i> | <i>Target Posture</i> | <i>M110</i> | <i>Rounds</i> | <i>Target Exposure Time</i> |
| 0 | Sketch card and cold bore | A | A-8 | STA | 200m | 1 | 10 minutes |
| 1 | Laser, known distance | A | E-type | STA | 200m | 2 | 30 seconds |
| 2 | Laser, known distance | A | E-type | STA | 100m | 2 | 30 seconds |
| 3 | Laser, North America or Europe, known distance | B | E-type | STA | 300m | 2 | 30 seconds |
| 4 | SWA or African, unknown distance | C | TMT-I | STA | 400m to 600m | 2 | 30 seconds |
| 5 | Blacked-out room, unknown distance | D | TMT-I | MOV | 400m to 600m | 2 | 35 seconds |
| 6 | Low parapet, unknown distance | E | TMT-I | MOV | 500m to 700m | 2 | 35 seconds |
| 7 | 6:12 pitch, unknown distance | E | TMT-I | MOV | 600m to 800m | 2 | 35 seconds |
| 8 | Bright room, unknown distance | F | TMT-I | MOV | 300m to 500m | 2 | 35 seconds |
| 9 | 12:12 pitch, unknown distance | G | TMT-I | EVA | 400m to 600m | 2 | 40 seconds |
| 10 | Parapet, unknown distance | G | TMT-I | EVA | 600m to 800m | 2 | 40 seconds |
| <p>Note. This course of fire is based on the capabilities of the automated sniper field fire (SFF) range or comparable facility. If the primary facility is not available, the unit should refer to the modified course of fire (known as MCOF).</p> | | | | | | | |
| <p>Legend: ENG – engagement, EVA – evasive target, FP – firing point, m – meter, MOV – moving target, STA – stationary target, SWA – Southwest Asia, TMT-I – trackless moving targets-Infantry</p> | | | | | | | |

Table G-65. M2010 sniper rifle, Table V, Practice, Stage 2, Night Fire, assisted, engagement sequence

| <i>M2010 Sniper Weapon System Engagements, Stage 2, Night Fire, Assisted</i> | | | | | | | |
|---|--|-----------|---------------|-----------------------|---------------|---------------|-----------------------------|
| <i>ENG</i> | <i>Task or Capability</i> | <i>FP</i> | <i>Target</i> | <i>Target Posture</i> | <i>M2010</i> | <i>Rounds</i> | <i>Target Exposure Time</i> |
| 0 | Sketch card and cold bore | A | A-8 | STA | 200m | 1 | 10 minutes |
| 1 | Laser, known distance | A | E-type | STA | 200m | 2 | 30 seconds |
| 2 | Laser, known distance | A | E-type | STA | 100m | 2 | 30 seconds |
| 3 | Laser, North America or Europe, known distance | B | E-type | STA | 300m | 2 | 30 seconds |
| 4 | SWA or African, unknown distance | C | TMT-I | STA | 400m to 600m | 2 | 30 seconds |
| 5 | Blacked-out room, unknown distance | D | TMT-I | MOV | 400m to 600m | 2 | 35 seconds |
| 6 | Low parapet, unknown distance | E | TMT-I | MOV | 500m to 700m | 2 | 35 seconds |
| 7 | 6:12 pitch, unknown distance | E | TMT-I | MOV | 600m to 800m | 2 | 35 seconds |
| 8 | Bright room, unknown distance | F | TMT-I | MOV | 300m to 500m | 2 | 35 seconds |
| 9 | 12:12 pitch, unknown distance | G | TMT-I | EVA | 800m to 1000m | 2 | 40 seconds |
| 10 | Parapet, unknown distance | G | TMT-I | EVA | 800m to 1000m | 2 | 40 seconds |
| <p>Note. This course of fire is based on the capabilities of the automated sniper field fire (SFF) range or comparable facility. If the primary facility is not available, the unit should refer to the modified course of fire (known as MCOF).</p> <p>Legend: ENG – engagement, EVA – evasive target, FP – firing point, m – meter, MOV – moving target, STA – stationary target, SWA – Southwest Asia, TMT-I – trackless moving targets-Infantry</p> | | | | | | | |

Table G-66. M107 sniper rifle, Table V, Practice, Stage 2, Night Fire, assisted, engagement sequence

| <i>M107 Sniper Weapon System Engagements, Stage 2, Night Fire, Assisted,</i> | | | | | | | |
|---|---|-----------|----------------------------|-----------------------|----------------------|---------------|-----------------------------|
| <i>ENG</i> | <i>Task or Capability</i> | <i>FP</i> | <i>Target</i> | <i>Target Posture</i> | <i>M2010</i> | <i>Rounds</i> | <i>Target Exposure Time</i> |
| 0 | Sketch card and cold bore | A | A-8 | STA | 200m | 1 | 10 minutes |
| 1 | Reconfigurable, known distance | A | E-type | STA | 600m | 2 | 30 seconds |
| 2 | Reconfigurable, known distance | A | E-type | STA | 400m | 2 | 30 seconds |
| 3 | North America or Europe, known distance | B | L3T-FRT TMT-V Driver | STA | 900m | 2 | 30 seconds |
| 4 | SWA or African, unknown distance | C | L2T-FRT TMT-V Engine | STA | 600m to 800m | 2 | 30 seconds |
| 5 | Blacked-out room, unknown distance | D | L2T-FLK TMT-V Driver | MOV | 1200m to 1300m | 2 | 35 seconds |
| 6 | Low parapet, unknown distance | E | L3T-FLK TMT-V Driver | MOV | 1400m to 1600m | 2 | 35 seconds |
| 7 | 6:12 pitch, unknown distance | E | L2T-FLK TMT-V Driver | MOV | 1200m to 1300m | 2 | 35 seconds |
| 8 | Bright room, unknown distance | F | L3T-FLK TMT-V Engine | MOV | 1400m to 1600m | 2 | 35 seconds |
| 9 | 12:12 pitch, unknown distance | G | L2T-FLK TMT-V Engine | EVA | 1200m to 1400m | 2 | 40 seconds |
| 10 | Parapet, unknown distance | G | L3T-FLK TMT-V Driver | EVA | 1400m to 1600m | 2 | 40 seconds |
| <p>Note. This course of fire is based on the capabilities of the heavy sniper range (HSR) range or comparable facility. If the primary facility is not available, the unit should refer to the modified course of fire (known as MCOF).</p> <p>Legend: ENG – engagement, EVA – evasive target, FP – firing point, m – meter, MOV – moving target, STA – stationary target, SWA – Southwest Asia, TMT-V – trackless moving targets-vehicle</p> | | | | | | | |

G-94. Table G-67 provides the Table V, Practice, Stage 2, Night Fire, Assisted, throughput schedule. Units use table G-67 as a guide. The guide portrays the overall efficiency of the range facility when conducting the training event. Table G-67 provides the overall throughput timetable based on the time the unit requires to remove one firing order from the firing positions and move the next firing order forward.

Table G-67. Sniper rifle, Table V, Practice, Stage 2, Night Fire, assisted throughput time schedule

| <i>Phase</i> | <i>Time to Execute</i> | <i>Remarks</i> | |
|---|---------------------------|--|--|
| Stationary Targets | 14:00 minutes | Sketch card and cold bore are conducted as the sniper team awaits the Tower instructions to the first firing point. Does not include administrative time to exit or enter the sniper teams to their designated start position. | |
| Moving Targets | 14:20 minutes | | |
| Evasive Targets | 7:20 minutes | | |
| Total Time Per Firing Order | 35:40 minutes | | |
| Firing Orders | Simultaneous Sniper Teams | | |
| | 1 Sniper Team | 2 Sniper Teams | 3 Sniper Teams |
| 2 | 1 hr 10 min | 4 | 6 |
| 3 | 1 hr 45 min | 6 | 9 |
| 4 | 2 hrs 20 min | 8 | 12 |
| 5 | 2 hrs 55 min | 10 | 15 |
| 6 | 3 hrs 30 min | 12 | 18 |
| 7 | 4 hrs 5 min | 14 | 21 |
| 8 | 4 hrs 40 min | 16 | 24 |
| 9 | 5 hrs 15 min | 18 | 27 |
| 10 | 5 hrs 50 min | 20 | 30 (ABCT) |
| 11 | 6 hrs 25 min | 22 | 33 |
| 12 | 7 hrs 0 min | 24 | 36 |
| 13 | 7 hrs 35 min | 26 | 39 (IBCT) |
| 14 | 8 hrs 10 min | 28 | 42 |
| 15 | 8 hrs 45 min | 30 (ABCT) | 45 |
| 16 | 9 hrs 20 min | 32 | 48 (SBCT) |
| 17 | 9 hrs 55 min | 34 | Snipers per BCT Type: ABCT = 30 IBCT = 37 SBCT = 48 |
| 18 | 10 hrs 30 min | 36 | |
| 19 | 11 hrs 5 min | 38 (IBCT) | |
| 20 | 11 hrs 40 min | 40 | |
| 21 | 12 hrs 15 min | 42 | |
| Note. Due to the increased time for each firing order, the throughput schedule does not continue past 12 hours of limited visibility conditions. | | | |
| Legend: ABCT – Armor brigade combat team, BCT – brigade combat team, hr – hour, hrs – hours, IBCT – Infantry brigade combat team, min – minute, SBCT – Stryker brigade combat team | | | |

CONDUCT OF THE RANGE

G-95. Leaders instruct snipers on the objectives of Table V, Practice, Stage 2, Night Fire, Assisted, and the importance of the functional elements of the shot process. Table V, Practice, Stage 2, Night Fire, Assisted, contains 11 firing tasks with an administrative pause programmed at the end of each engagement to facilitate changing firing positions.

G-96. Snipers enter the range and move to their firing points. Once at the firing point, firers assume a prone supported firing position with weapons in a green status. Firers fire Table V tasks from the ready at varying firing positions throughout the duration of the course of fire. The sniper teams conduct the course of fire such that—

- Task 0, sketch card and cold bore shot, is completed prior to conducting the scored engagements.
- All engagements in the scored events are fired from positions established by the sniper using available equipment, attachments, or surrounding items.
- First round hits receive 10 points.
- Second round hits receive 5 points.
- No points are awarded for hits beyond the second round or for targets not hit.

G-97. Firers must score a minimum of 140 of 200 points (70 percent) on the 10 engagements presented to successfully pass this event with a minimum of 70 points in stage 1 and 70 points in stage 2. It is not required for Soldiers to successfully complete this table before conducting Table VI. This event is purposefully more rigorous than the qualification event where the targets are presented in a rapid tempo, and the time to transition between firing positions and tactical reloading are reduced. Leaders annotate the official record of training on DA Form 7811.



G-98. Snipers begin Table V by moving into the firing position following administrative commands from the tower operator. Tower operators use administrative commands to control the flow of the range, movement of personnel, and other command and control purposes. Table G-68 provides an example of the administrative commands for moving a new firing order into position.

Table G-68. Table V, new firing order, conduct of the range example

| New Firing Order, Conduct of the Range | | | |
|--|---|---|-----------------------|
| SKETCH CARD AND COLD BORE SHOT PREPARATION | Task | Target | Target Type |
| | New Firing Order | N/A | N/A |
| | Rounds per Target | DODIC | Time (Seconds) |
| | N/A | AA11 (M110) A191 (M2010) A552 (M107) | NO LIMIT |
| TOWER | | SNIPER ACTION | |
| CONDUCT OF THE RANGE | SECURE YOUR AMMUNITION AND MOVE TO YOUR FIRING POINT | Snipers secure their weapon in a GREEN status, their training ammunition and move to the designated firing point. | |
| Once all snipers and spotters are complete, conduct of the range continues. | | | |
| Legend: DODIC – Department of Defense identification code, N/A – not applicable | | | |

G-99. Once the snipers are in the initial fighting position, they complete their sketch card and engagement 0, cold bore through coordination with the tower operator as shown in table G-69. This firing position should be separated from those snipers negotiating the course of fire, with all shots controlled and authorized by the tower operator.

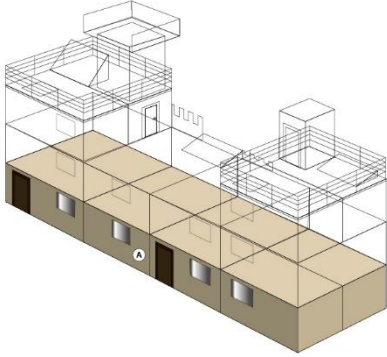
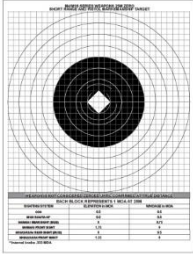
Table G-69. Table V, engagement 0, cold bore, conduct of fire example

| <i>Table V, Engagement 0 – Cold Bore</i> | | |
|---|--|--|
| Firing Position | M110 / M2010 Target | M107 Target |
|  |  OR |  10 inch Steel Plate |
| | 200 meters | 200 meters |
| Element | Tower Prompt | Remarks |
| WEAPONS SAFETY STATUS RED | GO TO PRONE MAKE READY | Sniper establishes a PRONE SUPPORTED position and loads the appropriate ammunition. |
| ALERT | SIERRA TANGO (ONE) | |
| TARGET DESCRIPTION | COLD BORE | |
| DIRECTION | TRP _____ | |
| RANGE | TWO-HUNDRED | |
| CONTROL | ONE ROUND WEAPONS FREE WEAPONS FREE | |
| EXECUTION | ENGAGE UPON POSITIVE IDENTIFICATION | Sniper is free to engage. |
| TERMINATION | CEASE FIRE CEASE FIRE | |
| WEAPONS SAFETY STATUS RED | | |
| ONCE COMPLETE, SNIPERS REPORT SET AND AWAIT INSTRUCTIONS FROM THE TOWER. | | |
| Legend: TRP - target reference point | | |

G-100. The following engagement sequence guide initiates the Table V scenario. Tables G-70 through G-79, on pages G-76 through G-84, are the engagement sequences with a generic conduct of fire process for the tower operator.

Table G-70. Sniper weapons, Table V, Practice, Stage 2, Night Fire, Assisted, engagement 1, conduct of fire example



| <i>Table V, Engagement 1 – Reconfigurable, Known Distance</i> | | |
|--|---|---|
| Firing Position | M110 / M2010 Target | M107 Target |
|  |  |  |
| | 200 meters | 600 meters |
| Element | Tower Prompt | Remarks |
| WEAPON SAFETY STATUS (UNIT MAY HAVE PLACED SNIPERS IN A GREEN STATUS AWAITING THEIR FIRING ORDER) | | |
| ALERT | SIERRA TANGO (ONE) | |
| TARGET DESCRIPTION | TROOP | |
| DIRECTION | TRP _____ | |
| CONTROL | TWO ROUNDS (LASER) WEAPONS FREE WEAPONS FREE | Laser for M110 and M2010 ONLY. |
| EXECUTION | ENGAGE UPON POSITIVE IDENTIFICATION | Sniper is free to engage. |
| TERMINATION | CEASE FIRE CEASE FIRE | |
| WEAPONS SAFETY STATUS RED | | |
| SNIPERS AWAIT COMMANDS FROM THE TOWER TO CONTINUE IN A RED STATUS. | | |
| SNIPERS ARE PROVIDED NO MORE THAN 3 MINUTES BETWEEN ENGAGEMENTS. | | |
| Legend: TRP - target reference point | | |

Table G-71. Sniper weapons, Table V, Practice, Stage 2, Night Fire, Assisted, engagement 2, conduct of fire example

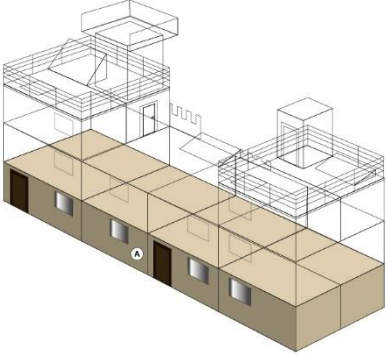

| <i>Table V, Engagement 2 – Reconfigurable, Known Distance</i> | | |
|---|---|---|
| Firing Position | M110 / M2010 Target | M107 Target |
|  |  |  |
| | 100 meters | 400 meters |
| Element | Tower Prompt | Remarks |
| WEAPONS SAFETY STATUS RED | | |
| ALERT | SIERRA TANGO (ONE) | |
| TARGET DESCRIPTION | HIGH VALUE TARGET | |
| DIRECTION | TRP _____ | |
| CONTROL | TWO ROUNDS (LASER) | Laser for M110 and M2010 ONLY. |
| | WEAPONS FREE WEAPONS FREE | |
| EXECUTION | ENGAGE UPON POSITIVE IDENTIFICATION | Sniper is free to engage. |
| TERMINATION | CEASE FIRE CEASE FIRE | |
| WEAPONS SAFETY STATUS RED | | |
| UPON COMPLETION OF THE ENGAGEMENT, THE TOWER DIRECTS THE SNIPER TEAM TO FIRING POSITION B – NORTH AMERICAN OR EUROPEAN ROOM AND REPORT SET. | | |
| SNIPER TEAMS HAVE 3 MINUTES FROM ACKNOWLEDGING TO REPORT SET IN FIRING POSITION B | | |
| Legend: TRP - target reference point | | |

Table G-72. Sniper weapons, Table V, Practice, Stage 2, Night Fire, Assisted, engagement 3, conduct of fire example

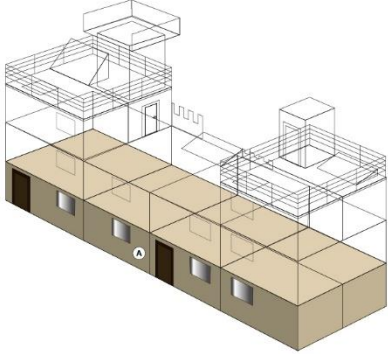

| <i>Table V, Engagement 3 – North American / European, Known Distance</i> | | |
|--|---|---|
| Firing Position | M110 / M2010 Target | M107 Target |
|  |  |  |
| | 300 meters | 900 meters |
| Element | Tower Prompt | Remarks |
| WEAPONS SAFETY STATUS RED | | |
| ALERT | SIERRA TANGO (ONE) | |
| TARGET DESCRIPTION | INSURGENT / DRIVER | |
| DIRECTION | TRP _____ | |
| CONTROL | TWO ROUNDS (LASER) WEAPONS FREE WEAPONS FREE | Laser for M110 and M2010 ONLY. |
| EXECUTION | ENGAGE UPON POSITIVE IDENTIFICATION | Sniper is free to engage. |
| TERMINATION | CEASE FIRE CEASE FIRE | |
| WEAPONS SAFETY STATUS RED | | |
| UPON COMPLETION OF THE ENGAGEMENT, THE TOWER DIRECTS THE SNIPER TEAM TO: FIRING POSITION C – SOUTHWEST ASIA OR AFRICAN ROOM AND REPORT SET. | | |
| SNIPER TEAMS HAVE 3 MINUTES FROM ACKNOWLEDGING TO REPORT SET IN FIRING POSITION C | | |
| Legend: TRP - target reference point | | |

Table G-73. Sniper weapons, Table V, Practice, Stage 2, Night Fire, Assisted, engagement 4, conduct of fire example

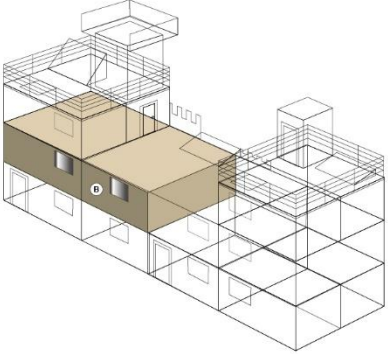

| <i>Table V, Engagement 4 – Southwest Asia / Africa, Unknown Distance</i> | | |
|---|--|---|
| Firing Position | M110 / M2010 Target | M107 Target |
|  |  TMT-I, STATIONARY 400 to 600 meters |  ENGINE 600 to 800 meters |
| Element | Tower Prompt | Remarks |
| WEAPON SAFETY STATUS RED | | |
| ALERT | SIERRA TANGO (ONE) | |
| TARGET DESCRIPTION | INSURGENT / FLEEING INSURGENT | |
| DIRECTION | TRP _____ | |
| CONTROL | TWO ROUNDS (IMMOBILIZE THE VEHICLE) WEAPONS FREE WEAPONS FREE | |
| EXECUTION | ENGAGE UPON POSITIVE IDENTIFICATION | Sniper is free to engage. |
| TERMINATION | CEASE FIRE CEASE FIRE | |
| WEAPONS SAFETY STATUS RED | | |
| UPON COMPLETION OF THE ENGAGEMENT, THE TOWER DIRECTS THE SNIPER TEAM TO: FIRING POSITION D – BLACKOUT ROOM AND REPORT SET. | | |
| SNIPER TEAMS HAVE 3 MINUTES FROM ACKNOWLEDGING TO REPORT SET IN FIRING POSITION D. | | |
| Legend: TMT-I – trackless moving targets–Infantry, TRP - target reference point | | |

Table G-74. Sniper weapons, Table V, Practice, Stage 2, Night Fire, Assisted, engagement 5, conduct of fire example

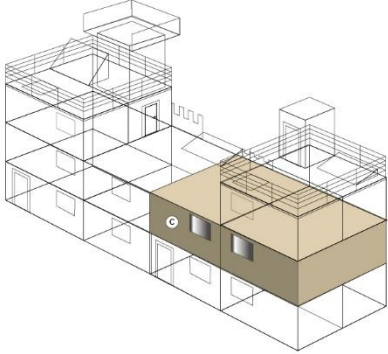

| <i>Table V, Engagement 5 – Blacked-Out Room, Unknown Distance</i> | | |
|--|--|--|
| Firing Position | M110 / M2010 Target | M107 Target |
|  |  TMT-I, MOVING 400 to 600 meters |  TMT-V, MOVING, DRIVER 1200 to 1300 meters |
| Element | Tower Prompt | Remarks |
| WEAPONS SAFETY STATUS RED | | |
| ALERT | SIERRA TANGO (ONE) | |
| TARGET DESCRIPTION | FLEEING INSURGENT (DRIVER) | |
| DIRECTION | TRP _____ | |
| CONTROL | TWO ROUNDS WEAPONS FREE WEAPONS FREE | |
| EXECUTION | ENGAGE UPON POSITIVE IDENTIFICATION | Sniper is free to engage. |
| TERMINATION | CEASE FIRE CEASE FIRE | |
| WEAPONS SAFETY STATUS RED | | |
| UPON COMPLETION OF THE ENGAGEMENT, THE TOWER DIRECTS THE SNIPER TEAM TO: FIRING POSITION E – LOW PARAPET AND REPORT SET. | | |
| SNIPER TEAMS HAVE 3 MINUTES FROM ACKNOWLEDGING TO REPORT SET IN FIRING POSITION E. | | |
| Legend: TMT-I – trackless moving targets-Infantry, TMT-V – trackless moving targets-vehicle, TRP - target reference point | | |

Table G-75. Sniper weapons, Table V, Practice, Stage 2, Night Fire, Assisted, engagement 6, conduct of fire example

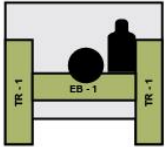

| <i>Table V, Engagement 6 – Low Parapet, Unknown Distance</i> | | |
|---|--|--|
| Firing Position | M110 / M2010 Target | M107 Target |
|  |  TMT-I, MOVING 500 to 700 meters |  TMT-V, MOVING, DRIVER 1400 to 1600 meters |
| Element | Tower Prompt | Remarks |
| WEAPON SAFETY STATUS RED | | |
| ALERT | SIERRA TANGO (ONE) | |
| TARGET DESCRIPTION | INBOUND HIGH VALUE TARGET (DRIVER) | |
| DIRECTION | TRP _____ | |
| CONTROL | TWO ROUNDS WEAPONS FREE WEAPONS FREE | |
| EXECUTION | ENGAGE UPON POSITIVE IDENTIFICATION | Sniper is free to engage. |
| TERMINATION | CEASE FIRE CEASE FIRE | |
| WEAPONS SAFETY STATUS RED | | |
| UPON COMPLETION OF THE ENGAGEMENT, THE TOWER DIRECTS THE SNIPER TEAM TO: FIRING POSITION E – 6:12 PITCH ROOF AND REPORT SET. | | |
| SNIPER TEAMS HAVE 3 MINUTES FROM ACKNOWLEDGING TO REPORT SET IN FIRING POSITION E. | | |
| Legend: TMT-I – trackless moving targets-Infantry, TMT-V – trackless moving targets-vehicle, TRP - target reference point | | |

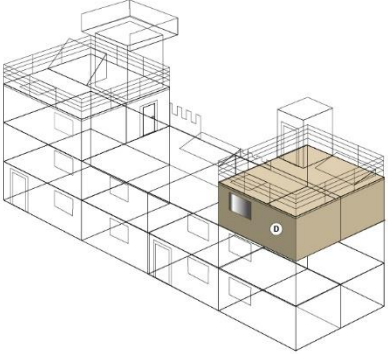
Table G-76. Sniper weapons, Table V, Practice, Stage 2, Night Fire, Assisted, engagement 7, conduct of fire example

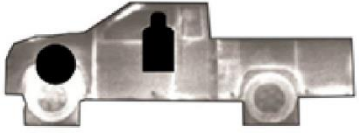

| <i>Table V, Engagement 7 – 6:12 Pitch Roof, Unknown Distance</i> | | |
|--|--|--|
| Firing Position | M110 / M2010 Target | M107 Target |
|  |  TMT-I, MOVING 600 to 800 meters |  TMT-V, MOVING, DRIVER 1200 to 1300 meters |
| Element | Tower Prompt | Remarks |
| WEAPON SAFETY STATUS RED | | |
| ALERT | SIERRA TANGO (ONE) | |
| TARGET DESCRIPTION | MOVING TROOP (DRIVER) | |
| DIRECTION | TRP ____ | |
| CONTROL | TWO ROUNDS WEAPONS FREE WEAPONS FREE | |
| EXECUTION | ENGAGE UPON POSITIVE IDENTIFICATION | Sniper is free to engage. |
| TERMINATION | CEASE FIRE CEASE FIRE | |
| WEAPONS SAFETY STATUS RED | | |
| UPON COMPLETION OF THE ENGAGEMENT, THE TOWER DIRECTS THE SNIPER TEAM TO: FIRING POSITION F – BRIGHT ROOM AND REPORT SET. | | |
| SNIPER TEAMS HAVE 3 MINUTES FROM ACKNOWLEDGING TO REPORT SET IN FIRING POSITION F. | | |
| Legend: TMT-I – trackless moving targets-Infantry, TMT-V – trackless moving targets-vehicle, TRP - target reference point | | |

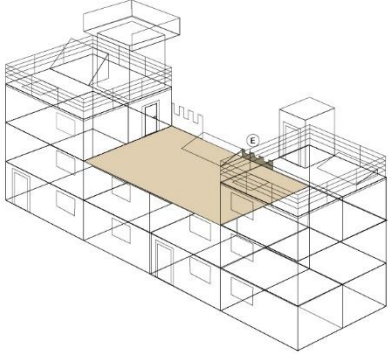
Table G-77. Sniper weapons, Table V, Practice, Stage 2, Night Fire, Assisted, engagement 8, conduct of fire example

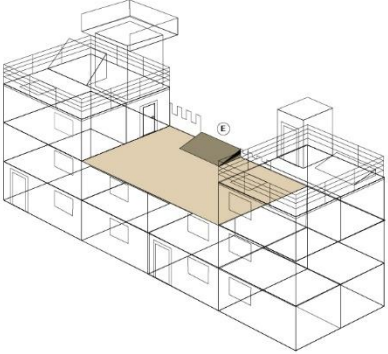

| <i>Table V, Engagement 8 – Bright Room, Unknown Distance</i> | | |
|--|--|--|
| Firing Position | M110 / M2010 Target | M107 Target |
|  |  TMT-I, MOVING 300 to 500 meters |  TMT-V, MOVING, ENGINE 1400 to 1600 meters |
| Element | Tower Prompt | Remarks |
| WEAPON SAFETY STATUS RED | | |
| ALERT | SIERRA TANGO (ONE) | |
| TARGET DESCRIPTION | FLEEING HIGH VALUE TARGET | |
| DIRECTION | TRP _____ | |
| CONTROL | TWO ROUNDS (IMMOBILIZE VEHICLE) WEAPONS FREE WEAPONS FREE | |
| EXECUTION | ENGAGE UPON POSITIVE IDENTIFICATION | Sniper is free to engage. |
| TERMINATION | CEASE FIRE CEASE FIRE | |
| WEAPONS SAFETY STATUS RED | | |
| UPON COMPLETION OF THE ENGAGEMENT, THE TOWER DIRECTS THE SNIPER TEAM TO: FIRING POSITION G – 12:12 PITCH ROOF AND REPORT SET. | | |
| SNIPER TEAMS HAVE 3 MINUTES FROM ACKNOWLEDGING TO REPORT SET IN FIRING POSITION G. | | |
| Legend: TMT-I – trackless moving targets-Infantry, TMT-V – trackless moving targets-vehicle, TRP - target reference point | | |

Table G-78. Sniper weapons, Table V, Practice, Stage 2, Night Fire, Assisted, engagement 9, conduct of fire example

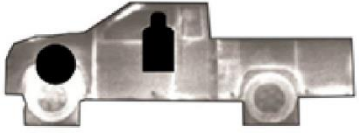

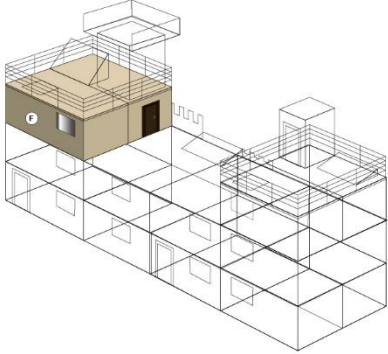

| <i>Table V, Engagement 9 – 12:12 Pitch Roof, Unknown Distance</i> | | |
|--|--|---|
| Firing Position | M110 / M2010 Target | M107 Target |
|  |  TMT-I, EVASIVE 400 to 600 meters (M110) 800 to 1000 meters (M2010) |  TMT-V, EVASIVE, ENGINE 1200 to 1400 meters |
| Element | Tower Prompt | Remarks |
| WEAPON SAFETY STATUS RED | | |
| ALERT | SIERRA TANGO (ONE) | |
| TARGET DESCRIPTION | INSURGENTS MOVING INTO SECTOR | |
| DIRECTION | TRP _____ | |
| CONTROL | TWO ROUNDS (IMMOBILIZE ENGINE) WEAPONS FREE WEAPONS FREE | |
| EXECUTION | ENGAGE UPON POSITIVE IDENTIFICATION | Sniper is free to engage. |
| TERMINATION | CEASE FIRE CEASE FIRE | |
| WEAPONS SAFETY STATUS RED | | |
| UPON COMPLETION OF THE ENGAGEMENT, THE TOWER DIRECTS THE SNIPER TEAM TO: FIRING POSITION G – PARAPET AND REPORT SET. | | |
| SNIPER TEAMS HAVE 3 MINUTES FROM ACKNOWLEDGING TO REPORT SET IN FIRING POSITION G. | | |
| Legend: TMT-I – trackless moving targets-Infantry, TMT-V – trackless moving targets-vehicle, TRP - target reference point | | |

Table G-79. Sniper weapons, Table V, Practice, Stage 2, Night Fire, Assisted, engagement 10, conduct of fire example

| <i>Table V, Engagement 10 – Parapet, 30-inch, Unknown Distance</i> | | |
|---|---|---|
| Firing Position | M110 / M2010 Target | M107 Target |
|  |  <p>TMT-I, EVASIVE</p> <p>600 to 800 meters (M110) 800 to 1000 meters (M2010)</p> |  <p>TMT-V, EVASIVE, DRIVER</p> <p>1400 to 1600 meters</p> |
| Element | Tower Prompt | Remarks |
| WEAPON SAFETY STATUS | | |
| ALERT | SIERRA TANGO (ONE) | |
| TARGET DESCRIPTION | FLEEING INSURGENT (DRIVER) | |
| DIRECTION | TRP _____ | |
| CONTROL | TWO ROUNDS WEAPONS FREE WEAPONS FREE | |
| EXECUTION | ENGAGE UPON POSITIVE IDENTIFICATION | Sniper is free to engage. |
| TERMINATION | CEASE FIRE CEASE FIRE | |
| WEAPONS SAFETY STATUS RED | | |
| AT THE COMPLETION OF THIS ENGAGEMENT, TOWER REQUESTS A SITUATION REPORT WITH ROUNDS EXPENDED. | | |
| ONCE SNIPER TEAM REPORTS, TOWER CONTINUES. | | |
| <p>Legend: TMT-I – trackless moving targets-Infantry, TMT-V – trackless moving targets-vehicle, TRP - target reference point</p> | | |

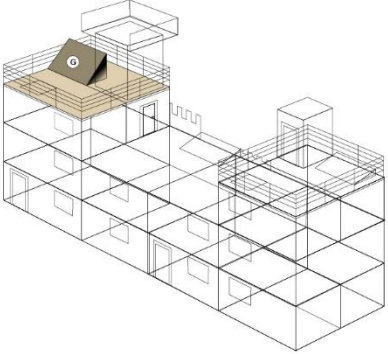
G-101. A lane safety clears the firers upon their completion of Table V and collecting their dunnage. A lane safety verifies the clearing prior to the Soldier moving from the firing point. Once the lane safety clears all the Soldiers, the lane safety communicates the WSS to the tower operator. The tower operator issues an administrative command to move the completed Soldiers off the range. Table G-80 is an example of this command.

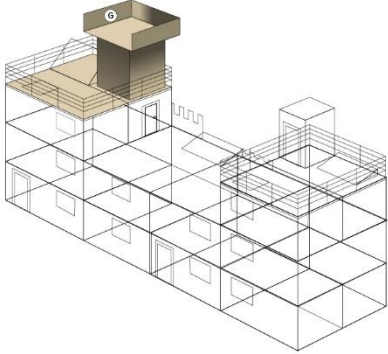
Table G-80. Table V, completed firing order, conduct of the range example

| <i>Firing Order Complete</i> | | | |
|--|--|--|----------------|
| FIRING ORDER COMPLETE | Task | Target | Target Type |
| | Completed Firing Order | N/A | N/A |
| | Rounds per Target | DODIC | Time (Seconds) |
| | N/A | N/A | NO LIMIT |
| TOWER | | SOLDIER ACTION | |
| WEAPONS SAFETY STATUS RED | | | |
| WEAPONS SAFETY STATUS GREEN | GO GREEN GO GREEN ONCE VERIFIED BY THE RSO, SECURE WEAPON | Soldiers clear their weapon and wait to be inspected by a lane safety. | |
| CONDUCT OF THE RANGE | SNIPERS SECURE YOUR DUNNAGE MOVE TO THE BASELINE. | Firers secure weapon and ammunition dunnage and move to the designated location. | |
| Once all snipers return to the baseline, tower directs the firing order off the range. | | | |
| Legend: DODIC – Department of Defense identification code, N/A – not applicable, RSO – range safety officer | | | |

G-102. As soon as the lane safety clears the completed firing order, the tower operator moves a new firing order moves into position and the process repeats itself until all firers have completed Table V, Practice, successfully. Any identified firers that require retraining move to the appropriate concurrent training location.

SNIPER RIFLE, TABLE VI, QUALIFICATION

G-103. Table VI, Qualification, is a practice table used to demonstrate the sniper's proficiency at common engagement and tactical skills. Table VI tasks challenge firers with single stationary and moving targets out to the weapon's maximum effective range from the prone unsupported position and other various challenging firing positions. The purpose of Table VI is to train the sniper to use their primary optic with their spotter to engage single targets placed in a tactical array and apply the functional elements of the shot process. In a timed scenario, the firer experiences and learns target prioritization and weapons manipulation. Leaders conduct Table VI tasks on an automated SFF, HSR, or comparable range facility.

TASK, CONDITIONS, AND STANDARD

G-104. Table G-81 outlines the tasks, conditions, and standards for the conduct of Table V. The sniper conducting the event should know the task, conditions, and standard and should explain them during the range briefing.

Table G-81. Sniper Rifle, Table V, Practice

| | |
|--------------------|---|
| Task: | Engage and defeat single stationary and moving threats at varying ranges from supported or unsupported standing, kneeling, and prone firing positions, during day and limited visibility conditions using full-caliber ammunition. |
| Conditions: | <p>Given the following:</p> <ul style="list-style-type: none"> • Fully mission capable weapon as assigned on the master authorization list for the unit. • Assigned primary optic, thermal optic, and pointer, illuminator, laser system. • Full combat uniform, issued equipment, and protective mask. • Authorized range facility. • Full-scale, approved targetry in standard scenario engagement sequences. • Authorized ammunition. • Trained and certified spotter. <p>Note. Units that do not have organic thermal weapon sights for the M110 or M2010 must coordinate within their brigade for the appropriate thermal optic.</p> |
| Standard: | Demonstrate engagement proficiency by scoring a minimum of 140 points (70 percent) of the total points possible (200 points). |

G-105. Table G-82 shows the training event design template for Sniper Rifle, Table VI, Qualification. Leaders conduct this event on an authorized live-fire facility, typically an MPMG or MPRC or comparable range facility. See TC 25-8 for additional information on authorized range facilities.

Table G-82. Training event design template for Sniper Rifle, Table VI, Qualification

| Sniper Rifle, Table VI, Qualification Live-Fire Proficiency Gate | | | | | | | |
|--|-----------------------|---------------------------|-------------------------|---------------------------------------|--------------------------|---------------------------------|-------------|
| EVENT NAME: | QUALIFICATION | ENVIRONMENT: | | LIVE | 1.0 | | |
| WEAPON: | M110 / M2010 / M107 | CONDITIONS: | | LIVE FIRE | | | |
| CATEGORY: | LIVE-FIRE PROFICIENCY | PRIMARY FACILITY: | | SFF HSR | DAYS REQUIRED | | |
| PUBLICATION: | TC 3-22.10 | ALTERNATE FACILITY: | | MPMG | | | |
| REQUIRED: | YES | COMPONENT: | AC | RC | 30 SNIPERS | | |
| RECORD: | DA Form 7811 | FREQUENCY: | 2 | 1 | | | |
| VALID FOR: | 12 MONTHS | ANNUAL DAYS TOTAL: | 2 | 1 | THROUGHPUT | | |
| TABLE | | | | | | | |
| | | I | II | III | IV | V | VI |
| | | PMI&E | PLFS | DRILLS | BASIC | PRACTICE | QUAL |
| | | PRQ | PRQ | PRQ | | | REQUIRED |
| WHEN EXECUTED: | | | | | | | T-X |
| CONDEMNATION CRITERIA (CC) | RULE 1 | RULE 2 | RULE 3 | RULE 4 | RULE 5 | RULE 6 | |
| | TIME | KEY LEADER TURNOVER | COMMANDER ASSESSMENT | SUBORDINATE ELEMENT PROFICIENCY | SPECIALTY PROFICIENCY | STAFF SECTION PROFICIENCY | |
| Remarks: Each Soldier assigned an individual weapon <i>must</i> successfully complete Table VI, Qualification to meet their live-fire proficiency gate. The live-fire proficiency gate is required for any Soldier to participate in <i>any collective live-fire event</i> . | | | | | | | |
| Note: Table III should be used as concurrent training on Tables IV, V, and VI while Soldiers are awaiting training in a firing order or between day and night phases. | | | | | | | |
| Legend: AC – active component (known as active duty), ARF – automated record fire range, DA – Department of the Army, EVAL – evaluation, HSR – heavy sniper range, MPMG – multipurpose machine gun range, PLFS – preliminary live-fire simulation, PMI&E – preliminary marksmanship instruction and evaluation, PRQ – prerequisite, QUAL – qualification, RC – Reserve Component (known as Reserves), SFF – automated sniper field fire range, TC – training circular, T-X – training event exercise, TNG DAYS TO QUAL – number of training days remaining on the critical path to weapon's qualification | | | | | | | |

AMMUNITION

G-106. All snipers assigned a sniper weapon system on a unit MAL complete Sniper Rifle, Table VI, Qualification, prior to advancing to collective training with a sniper weapon system. Leaders conduct this event to evaluate the Soldier's proficiency to lethally employ their sniper weapon system.

G-107. To effectively plan and forecast for sufficient training ammunition, the unit uses the ammunition requirements listed in table G-83, on page G-88. Units will need to identify the total number of snipers and weapon systems by type (caliber), and should plan for unscheduled firers and necessary retraining by increasing their forecasted training, as appropriate.

G-108. Table VI consists of two separate stages in the course of fire. The stages used during Table VI are—

- Stage 1 – Day Fire.
- Stage 2 – Night Fire, Assisted (pointer / illuminator and thermal).

G-109. Soldiers must successfully finish both course of fire stages to complete the course of fire.

G-110. Table VI is an automated, timed event that consists of engagements from nine different firing points through each stage. Leaders issue every sniper ammunition as shown in table G-83 to conduct the event to standard. Firers place ammunition in their ammunition pouches. Staging or pre-positioning ammunition is not authorized for the conduct of Table VI.

Table G-83. Sniper Rifle, Table VI, Qualification, ammunition requirements

| <i>Weapon</i> | <i>DODIC</i> | <i>Nomenclature</i> | <i>Stage 1 Day Fire</i> | <i>Stage 2 Night Fire Assisted</i> | <i>Total</i> |
|---------------|--------------|---|-----------------------------|--|--------------|
| M110 | A111 | CTG, 7.62mm, special ball, M118, long range | 21 | 21 | 42 |
| M2010 | A191 | CTG, .300 cal, win mag, match | 21 | 21 | 42 |
| M107 | A552 | CTG, .50 cal, ball, M2 / M33 | 21 | 21 | 42 |

Legend: cal – caliber, CTG – cartridge, DODIC – Department of Defense identification code, mm – millimeter

RANGE FACILITIES

G-111. Table G-84 shows the Army-standard range facilities designed to support sniper weapons system, Table VI, Qualification training. Units must refer to their installation’s range operations SOPs or local training regulation to identify the weapon specific range facilities. Units use their RFMSS system for all scheduling.

Table G-84. Sniper Rifle, Table VI, Qualification, authorized range facilities

| <i>Sniper Weapon Systems Range Facility Matrix</i> | | | | | | | |
|--|--------------------------------|------------|------------|-----------|-------------|------------|------------------|
| <i>Weapon</i> | <i>Standard Range Facility</i> | | | | | | |
| | <i>Zero</i> | <i>SFF</i> | <i>HSR</i> | <i>KD</i> | <i>MPMG</i> | <i>QTR</i> | <i>MAN Range</i> |
| M110 \ M110E1 | N/A | P | | A | A | A | A |
| M2010 | N/A | P | | A | A | A | A |
| M107 | N/A | | P | A | A | A | A |

Note.
For installations that do not have facilities with the multi-story, multi-environment structure or the trackless moving targets, they must use the modified courses of fire (known as MCOF).
For units that must use the MPMG or QTR for sniper training, they must use the MCOF.

Legend: A – alternate authorized facility, HSR – heavy sniper range, KD – known distance range, MPMG – multipurpose machine gun range, MAN Range – maneuver range facility, N/A – not authorized, P – primary, SFF – automated sniper field fire range, QTR – qualification training range, Zero – basic 10 meter / 25 meter firing range (zero)

G-112. Figure G-9 shows the firing positions in the multistory, multi-environment used during this course of firing platform. Units that do not have access to a primary facility with the MSME firing platform utilize the firing positions provided on the primary range facility. When required to displace to the next firing position, the tower operator must announce which lane the sniper team will advance to.

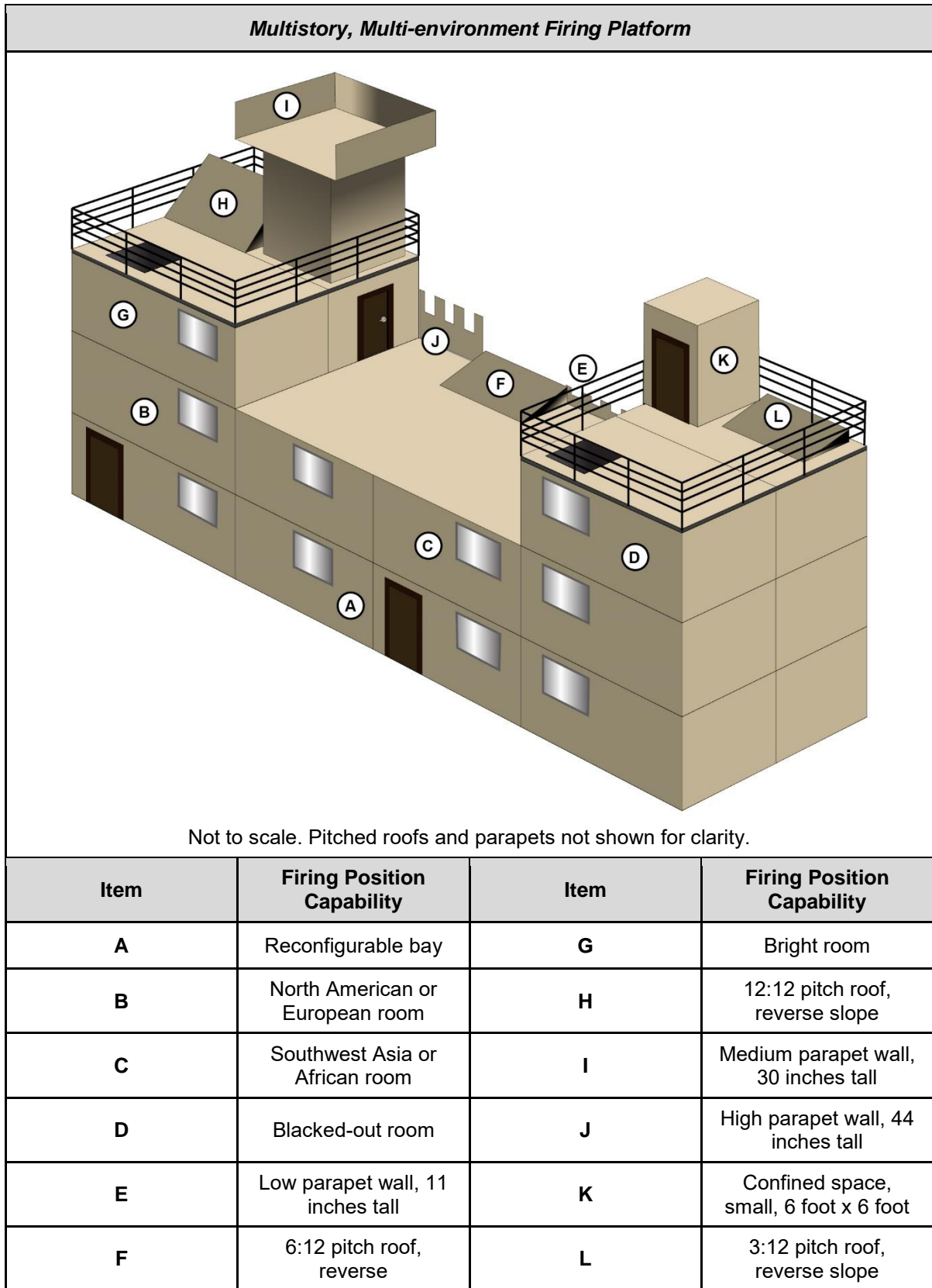

Figure G-9. Multistory, multi-environment firing platform established firing positions example

TARGETRY

G-113. Table VI training requires silhouette targetry, either E-type, F-type, or D-type targets on the range. The leader must confirm the type and capability of the range’s targetry, lifting mechanisms, simulators, and identify any unit requirements. During the preparation phase, leaders should be familiar with the targetry used and the sequence of the firing events. Figure G-10 shows the authorized targetry used during Table VI training.



| Sniper Weapons Targetry Requirements | |
|---|--|
| <p>A-8, Target zero M4- / M16-series weapons 25-meters zero. Short range and pistol marksmanship target.</p> <p>8 ½" x 11"</p> <p>NSN 6920-01-660-9191</p> <p>Note: Recommended for cold bore shot at 200-meters. Outer 8-inch ring = 4 MOA.</p> <p>Units may select any target to complete the cold bore shot at 200-meters.</p> |  |
| <p>E-1, Target, silhouette: plastic, polyethylene, kneeling</p> <p>NSN 6920-00-071-4780</p> <p>Note: When TMT-I movers are used, other similar targets may be used.</p> |  |
| <p>D-1, Target, 3-dimensional: plastic, mannequin, kneeling</p> <p>NSN 6920-01-164-9625</p> <p>Note: When TMT-I movers are used, other similar targets may be used.</p> |  |
| <p>I-type, Steel silhouette or 10-inch steel round.</p> <p>NSN: 6920-00-071-4780</p> <p>Note: May be locally manufactured or procured.</p> <p>Typically, steel targets are not authorized at less than 100 meters. Units must coordinate for steel targetry authorization.</p> |  |
| <p>Legend: “ – inch, MOA – minute of angle, NSN – national stock number, TMT-I – trackless moving targets- Infantry</p> | |

Figure G-10. Authorized target types

G-114. Figure G-11 shows the stationary, frontal target options. Frontal targets are required for the M107 engagements. Leaders may replace any stationary, frontal target with any other stationary, frontal target listed. The kill plates for the engine compartment should be large enough to account for 3 MOA at distance.

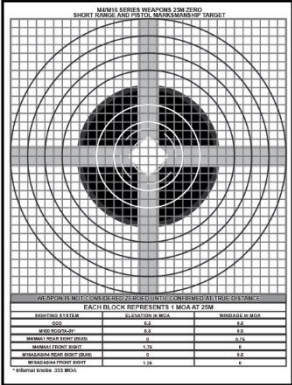

| Sniper Weapons, Stationary Frontal Targetry | |
|---|--|
| <p>L2T-FRT, Light armor, technical truck, threat, frontal Plywood with thermal blankets</p> <p>Locally manufactured (see Training Circular [TC] 25-8)</p> |  |
| <p>L2T-FRT-C, Light armor, technical truck, threat, frontal, vehicle combat identification (VCID) with integrated thermalization.</p> <p>Note. Not all installations have the VCID targets. Units must coordinate with their supporting installation's range operations.</p> |  |
| <p>L3T-FRT, Light Armor, sedan, threat, frontal Plywood with thermal blanket</p> <p>Locally manufactured (see TC 25-8)</p> |  |
| <p>Note. Thermal blankets are applied to the targets as depicted above or in TC 25-8. The unit applies the metal strike plates as required: driver and engine block. The sniper must strike the portion of the target identified in the tower script or prompt.</p> | |

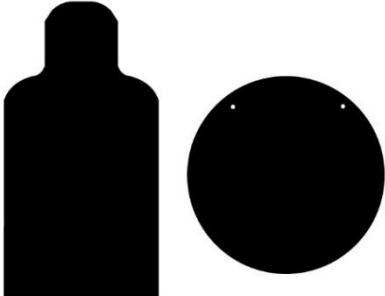
Figure G-11. Authorized targets, frontal types

G-115. Figure G-12 shows the stationary and moving flank target options. Flank targets are required for the M107 engagements. Any leaders may replace any flank target with any other flank target listed. The kill plates for the engine compartment should be large enough to account for 3 MOAs at distance.

| Sniper Weapons, Stationary Flank Targetry | |
|---|--|
| <p>L2T-FLK, Light armor, technical truck, threat, flank Plywood with thermal blankets</p> <p>Locally manufactured (see Training Circular [TC] 25-8)</p> | |
| <p>L2T-FLK-C, Light armor, technical truck, threat, flank, vehicle combat identification (VCID) with integrated Thermalization.</p> <p>Note. Not all installations have the VCID targets. Units must coordinate with their supporting installation's range operations.</p> | |
| <p>L3T-FLK, Light armor, sedan, threat, flank Plywood with Thermal Blanket</p> <p>Locally manufactured (see TC 25-8)</p> | |
| <p>Note. Thermal blankets are applied to the targets as depicted above or in TC 25-8. The unit applies the metal strike plates as required: driver and engine block. The sniper must strike the portion of the target identified in the tower script or prompt.</p> | |

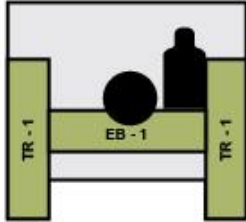
Figure G-12. Authorized targets, flank types

AUTHORIZED MODIFICATIONS

G-116. In the event the installation does not have the primary structures, instrumentation, or target lifting mechanisms, the unit is authorized to modify the course of fire. Table G-85 provides the authorized list of modifications the unit can apply to the course of fire. Units should provide feedback to their installation when modifications to the course of fire are required to highlight training gaps on their installation, as appropriate.

Table G-85. Authorized modifications to the course of fire

| <i>Sniper Range Facility Authorized Modifications to the Course of Fire</i> | | | |
|--|--|--|---|
| <i>Structure, Instrumentation, or Targetry</i> | <i>Authorized Modification</i> | <i>Alternate Modification</i> | <i>Remarks</i> |
| Multistory, multi-environment firing platform | Eight separate, ground-based firing positions. | Use multipurpose maneuver range with Air-Ground Integration Villages. | The purpose is to provide the sniper team challenging firing positions that require critical thinking to overcome firing position conditions. |
| Trackless Moving Targets-Infantry (TMT-I) | Standard moving Infantry targets (MITs) at the appropriate distance. | Use standard Iron Maiden targets at the appropriate distance when no MIT is available. | Ensure the targetry is programmed according to the target's posture: moving or evasive. |
| Trackless moving Targets-vehicle (TMT-V) | Standard moving Armor target (MAT) at the appropriate distance. | Standard stationary Armor target (SAT) at the appropriate distance. | Ensure the targetry is programmed according to the target's posture: moving or evasive. |
| Engine or driver kill zones | Cut out appropriate areas on the target and apply steel hit plates for down-range feedback | | |
| <p>Note. For units conducting the training in austere environments, or with international partners, the most stringent range safety regulations, policies, and requirements are followed.</p> <p>Any use of steel hit plates or similar items requires approval from the supporting installation's range safety office.</p> | | | |

SNIPER WEAPON SYSTEMS, TABLE VI, STAGE 1, DAY FIRE

G-117. Table VI consists of two separate stages in the course of fire. The stages used during Table VI are—

- Stage 1 – Day Fire.
- Stage 2 – Night Fire, Assisted (pointer / illuminator and thermal).

G-118. Soldiers must successfully finish both course of fire stages. The following paragraphs describe the course of fire for Table VI, Stage 1, Day Fire.

SCENARIO ENGAGEMENTS

G-119. Targets are presented to the sniper in single target arrays. Targets are presented such that 90-percent of the target is clearly visible to the sniper from the expected or planned firing position. Targets are exposed to the sniper based on the target’s tactical posture presented during the engagement as follows:

- Stationary target engagements are exposed for 30 seconds.
- Moving target engagements are exposed for 45 seconds.
- Evasive target engagements are exposed for 60 seconds.

G-120. The sniper and spotter have four minutes to establish their firing position and report SET to the sniper team leader after each engagement. During the transition period to the next engagement or firing position, the sniper and spotter are responsible to reload as appropriate, update their sketch card, and establish the best prone supported firing position overlooking the directed target area. Tables G-86 through G-88, on pages G-94 through G-96, show the scenario engagement sequence for Table VI.

Table G-86. M110 sniper rifle, Table VI, Qualification, stage 1, day fire, engagement sequence

| <i>M110 Sniper Weapon System Engagements, Stage 1, Day Fire</i> | | | | | | | |
|---|---|-----------|---------------|-----------------------|--------------|---------------|-----------------------------|
| <i>ENG</i> | <i>Task or Capability</i> | <i>FP</i> | <i>Target</i> | <i>Target Posture</i> | <i>M110</i> | <i>Rounds</i> | <i>Target Exposure Time</i> |
| 0 | Sketch card and cold bore | A | A-8 | STA | 200m | 1 | 10 minutes |
| 1 | Reconfigurable, known distance | A | E-type | STA | 500m | 2 | 20 seconds |
| 2 | Reconfigurable, known distance | A | E-type | STA | 800m | 2 | 20 seconds |
| 3 | North America or Europe, known distance | B | E-type | STA | 600m | 2 | 20 seconds |
| 4 | SWA or African, unknown distance | C | TMT-I | STA | 400m to 600m | 2 | 20 seconds |
| 5 | Blacked-out room, unknown distance | D | TMT-I | MOV | 400m to 600m | 2 | 25 seconds |
| 6 | Low parapet, unknown distance | E | TMT-I | MOV | 500m to 700m | 2 | 25 seconds |
| 7 | 6:12 pitch, unknown distance | E | TMT-I | MOV | 600m to 800m | 2 | 25 seconds |
| 8 | Bright room, unknown distance | F | TMT-I | MOV | 300m to 500m | 2 | 25 seconds |
| 9 | 12:12 pitch, unknown distance | G | TMT-I | EVA | 400m to 600m | 2 | 30 seconds |
| 10 | Parapet, unknown distance | G | TMT-I | EVA | 600m to 800m | 2 | 30 seconds |
| <p>Note. This course of fire is based on the capabilities of the automated sniper field fire (SFF) range or comparable facility. If the primary facility is not available, the unit should refer to the modified course of fire (known as MCOF).</p> <p>Legend: ENG – engagement, EVA – evasive target, FP – firing point, m – meter, MOV – moving target, SWA – Southwest Asia, STA – stationary target, TMT-I – trackless moving targets-Infantry</p> | | | | | | | |

Table G-87. M2010 sniper rifle, Table VI, Qualification, stage 1, day fire, engagement sequence

| <i>M2010 Sniper Weapon System Engagements, Stage 1, Day Fire</i> | | | | | | | |
|--|---|-----------|---------------|-----------------------|---------------|---------------|-----------------------------|
| <i>ENG</i> | <i>Task or Capability</i> | <i>FP</i> | <i>Target</i> | <i>Target Posture</i> | <i>M2010</i> | <i>Rounds</i> | <i>Target Exposure Time</i> |
| 0 | Sketch card and cold bore | A | A-8 | STA | 200m | 1 | 10 minutes |
| 1 | Reconfigurable, known distance | A | E-type | STA | 500m | 2 | 20 seconds |
| 2 | Reconfigurable, known distance | A | E-type | STA | 800m | 2 | 20 seconds |
| 3 | North America or Europe, known distance | B | E-type | STA | 600m | 2 | 20 seconds |
| 4 | SWA or African, unknown distance | C | TMT-I | STA | 400m to 600m | 2 | 20 seconds |
| 5 | Blacked-out room, unknown distance | D | TMT-I | MOV | 400m to 600m | 2 | 25 seconds |
| 6 | Low parapet, unknown distance | E | TMT-I | MOV | 500m to 700m | 2 | 25 seconds |
| 7 | 6:12 pitch, unknown distance | E | TMT-I | MOV | 600m to 800m | 2 | 25 seconds |
| 8 | Bright room, unknown distance | F | TMT-I | MOV | 300m to 500m | 2 | 25 seconds |
| 9 | 12:12 pitch, unknown distance | G | TMT-I | EVA | 800m to 1000m | 2 | 30 seconds |
| 10 | Parapet, unknown distance | G | TMT-I | EVA | 800m to 1000m | 2 | 30 seconds |
| Note. This course of fire is based on the capabilities of the automated sniper field fire (SFF) range or comparable facility. If the primary facility is not available, the unit should refer to the modified course of fire (known as MCOF). | | | | | | | |
| Legend: ENG – engagement, EVA – evasive target, FP – firing point, m – meter, MOV – moving target, SWA – Southwest Asia, STA – stationary target, TMT-I – trackless moving targets-Infantry | | | | | | | |

Table G-88. M107 sniper rifle, Table VI, Qualification, stage 1, day fire, engagement sequence

| <i>M107 Sniper Weapon System Engagements, Stage 1, Day Fire</i> | | | | | | | |
|---|---|-----------|----------------------------|-----------------------|----------------|---------------|-----------------------------|
| ENG | Task or Capability | FP | Target | Target Posture | M2010 | Rounds | Target Exposure Time |
| 0 | Sketch card and cold bore | A | A-8 | STA | 200m | 1 | 10 minutes |
| 1 | Reconfigurable, known distance | A | E-type | STA | 600m | 2 | 20 seconds |
| 2 | Reconfigurable, known distance | A | E-type | STA | 400m | 2 | 20 seconds |
| 3 | North America or Europe, known distance | B | L3T-FRT TMT-V Driver | STA | 900m | 2 | 20 seconds |
| 4 | SWA or African, unknown distance | C | L2T-FRT TMT-V Engine | STA | 600m to 800m | 2 | 20 seconds |
| 5 | Blacked-out room, unknown distance | D | L2T-FLK TMT-V Driver | MOV | 1200m to 1300m | 2 | 25 seconds |
| 6 | Low parapet, unknown distance | E | L3T-FLK TMT-V Driver | MOV | 1400m to 1600m | 2 | 25 seconds |
| 7 | 6:12 pitch, unknown distance | E | L2T-FLK TMT-V Driver | MOV | 1200m to 1300m | 2 | 25 seconds |
| 8 | Bright room, unknown distance | F | L3T-FLK TMT-V Engine | MOV | 1400m to 1600m | 2 | 25 seconds |
| 9 | 12:12 pitch, unknown distance | G | L2T-FLK TMT-V Engine | EVA | 1200m to 1400m | 2 | 30 seconds |
| 10 | Parapet, unknown distance | G | L3T-FLK TMT-V Driver | EVA | 1400m to 1600m | 2 | 30 seconds |
| <p>Note. This course of fire is based on the capabilities of the heavy sniper range (HSR) or comparable facility. If the primary facility is not available, the unit should refer to the modified course of fire (known as MCOF).</p> <p>Legend: ENG – engagement, EVA – evasive target, FP – firing point, m – meter, MOV – moving target, SWA – Southwest Asia, STA – stationary target, TMT-V – trackless moving targets-vehicle</p> | | | | | | | |

G-121. Table G-89 provides the Table VI, Qualification, Stage 1, Day Fire, throughput schedule. It is a guide to units that portrays the overall efficiency of the range facility when conducting the training event.

Table G-89. Sniper rifle, Table VI, Qualification, stage 1, day fire, throughput time schedule

| <i>Phase</i> | <i>Time to Execute</i> | <i>Remarks</i> | |
|---|----------------------------------|--|-----------------------|
| Stationary Targets | 18:00 minutes | Sketch card and cold bore are conducted as the sniper team awaits the tower instructions to the first firing point. Does not include administrative time to exit or enter the sniper teams to their designated start position. | |
| Moving Targets | 19:00 minutes | | |
| Evasive Targets | 10:00 minutes | | |
| Total Time Per Firing Order | 42:00 minutes | | |
| <i>Firing Orders</i> | <i>Simultaneous Sniper Teams</i> | | |
| | <i>1 Sniper Team</i> | <i>2 Sniper Teams</i> | <i>3 Sniper Teams</i> |
| 2 | 1 hr 24 min | 4 | 6 |
| 3 | 2 hrs 6 min | 6 | 9 |
| 4 | 2 hrs 48 min | 8 | 12 |
| 5 | 3 hrs 30 min | 10 | 15 |
| 6 | 4 hrs 12 min | 12 | 18 |
| 7 | 4 hrs 54 min | 14 | 21 |
| 8 | 5 hrs 36 min | 16 | 24 |
| 9 | 6 hrs 18 min | 18 | 27 |
| 10 | 7 hrs 0 min | 20 | 30 (ABCT) |
| 11 | 7 hrs 42 min | 22 | 33 |
| 12 | 8 hrs 24 min | 24 | 36 |
| 13 | 9 hrs 6 min | 26 | 39 (IBCT) |
| 14 | 9 hrs 48 min | 28 | 42 |
| 15 | 10 hrs 30 min | 30 (ABCT) | 45 |
| 16 | 11 hrs 12 min | 32 | 48 (SBCT) |
| 17 | 11 hrs 54 min | 34 | |
| 18 | 12 hrs 36 min | 36 | |
| Snipers per BCT Type: | ABCT = 30 | IBCT = 37 | SBCT = 48 |
| Legend: ABCT – Armor brigade combat team, BCT – brigade combat team, hr – hour, hrs – hours, IBCT – Infantry brigade combat team, min – minute, SBCT – Stryker brigade combat team | | | |

CONDUCT OF THE RANGE

G-122. Leaders instruct snipers on the objectives of Table VI and the importance of the functional elements of the shot process. Table VI, Stage 1, Day Fire, contains 11 firing tasks with an administrative pause programmed at the end of each engagement to facilitate change of firing positions.

G-123. Snipers enter the range and move to their firing points. Once at the firing point, firers assume a prone supported firing position with weapons in a green status. Firers fire Table VI from the ready at varying firing positions throughout the course of fire. The sniper teams conduct the course of fire so that—

- Task 0, sketch card and cold bore shot, is completed prior to conducting the scored engagements.
- All engagements in the scored events are fired from positions established by the sniper using available equipment, attachments, or surrounding items.
- First round hits receive 10 points.
- Second round hits receive 5 points.
- No points are awarded for hits beyond the second round or for targets not hit.

G-124. Firers must score a minimum of 140 of 200 points (70 percent) on the 10 engagements presented to successfully pass this event with a minimum of 70 points in stage 1 and 70 points in stage 2. Leaders annotate the official record of training is annotated on DA Form 7811.

G-125. Snipers begin Table VI by moving into the firing position following administrative commands from the tower operator. Tower operators use administrative commands to control the flow of the range, movement of personnel, and other command and control purposes. Table G-90 provides an example of the administrative commands for moving a new firing order into position.

Table G-90. Table VI, new firing order, conduct of the range example

| <i>New Firing Order, Conduct of the Range</i> | | | |
|--|---|---|-----------------------|
| | Task | Target | Target Type |
| SKETCH CARD AND COLD BORE SHOT PREPARATION | New Firing Order | N/A | N/A |
| | Rounds per Target | DODIC | Time (Seconds) |
| | N/A | AA11 (M110) A191 (M2010) A552 (M107) | NO LIMIT |
| TOWER | SOLDIER ACTION | | |
| CONDUCT OF THE RANGE | SECURE YOUR AMMUNITION AND MOVE TO YOUR FIRING POINT | Snipers secure their weapon in a GREEN status, their training ammunition and move to the designated firing point. | |
| Once all snipers and spotters are complete, conduct of the range continues. | | | |
| Legend: DODIC – Department of Defense identification code, N/A – not applicable | | | |

G-126. Once the snipers are in the initial fighting position, they complete their sketch card and engagement 0, cold bore through coordination with the tower operator as shown in table G-91. This firing position should be separated from those snipers negotiating the course of fire, with all shots controlled and authorized by the tower operator.

Table G-91. Table VI, engagement 0, cold bore, conduct of fire example

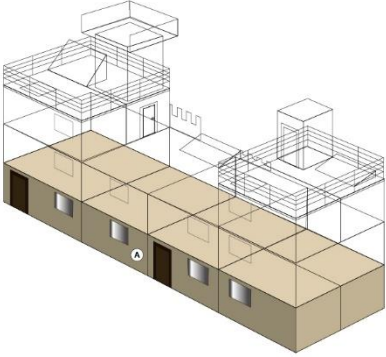
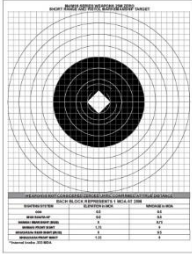
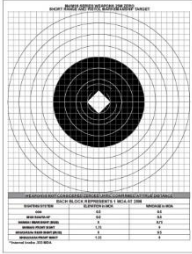
| <i>Table VI, Engagement 0 – Cold Bore</i> | | |
|---|---|--|
| Firing Position | M110 / M2010 Target | M107 Target |
|  |  |  |
| | 200 meters | 200 meters |
| Element | Tower Prompt | Remarks |
| WEAPONS SAFETY STATUS RED | GO TO PRONE MAKE READY | Sniper moves to the PRONE supported position, establishes a good firing position, and loads the appropriate ammunition. |
| ALERT | SIERRA TANGO (ONE) | |
| TARGET DESCRIPTION | COLD BORE | |
| DIRECTION | TRP _____ | |
| RANGE | TWO-HUNDRED | |
| CONTROL | ONE ROUND | |
| | WEAPONS FREE WEAPONS FREE | |
| EXECUTION | ENGAGE UPON POSITIVE IDENTIFICATION | Sniper is free to engage. |
| TERMINATION | CEASE FIRE CEASE FIRE | |
| WEAPONS SAFETY STATUS RED | | |
| ONCE COMPLETE, SNIPERS REPORT SET AND AWAIT INSTRUCTIONS FROM THE TOWER. | | |
| Legend: TRP - target reference point | | |

G-127. The following engagement sequence guide initiates the Table VI scenario. The tables G-92 through G-101, on pages G-100 through G-109, are the engagement sequences with a generic conduct of fire process for the tower.

Table G-92. Sniper weapons, Table VI, stage 1, day fire, engagement 1, conduct of fire example



| <i>Table VI, Engagement 1 – Reconfigurable, Known Distance</i> | | |
|---|---|---|
| Firing Position | M110 / M2010 Target | M107 Target |
|  |  |  |
| | 500 meters | 600 meters |
| Element | Tower Prompt | Remarks |
| WEAPON SAFETY STATUS (UNIT MAY HAVE PLACED SNIPERS IN A GREEN STATUS AWAITING THEIR FIRING ORDER) | | |
| ALERT | SIERRA TANGO (ONE) | |
| TARGET DESCRIPTION | TROOP | |
| DIRECTION | TRP _____ | |
| CONTROL | TWO ROUNDS WEAPONS FREE WEAPONS FREE | |
| EXECUTION | ENGAGE UPON POSITIVE IDENTIFICATION | Sniper is free to engage. |
| TERMINATION | CEASE FIRE CEASE FIRE | |
| WEAPONS SAFETY STATUS RED | | |
| SNIPERS AWAIT COMMANDS FROM THE TOWER TO CONTINUE IN A RED STATUS. SNIPERS ARE PROVIDED NO MORE THAN FOUR MINUTES BETWEEN ENGAGEMENTS. | | |
| Legend: TRP - target reference point | | |

Table G-93. Sniper weapons, Table VI, stage 1, day fire, engagement 2, conduct of fire example

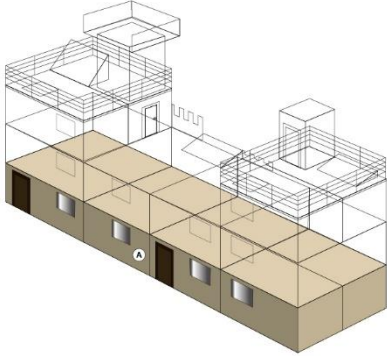

| <i>Table VI, Engagement 2 – Reconfigurable, Known Distance</i> | | |
|--|---|---|
| Firing Position | M110 / M2010 Target | M107 Target |
|  |  |  |
| | 800 meters | 400 meters |
| Element | Tower Prompt | Remarks |
| WEAPONS SAFETY STATUS RED | | |
| ALERT | SIERRA TANGO (ONE) | |
| TARGET DESCRIPTION | HIGH VALUE TARGET | |
| DIRECTION | TRP _____ | |
| CONTROL | TWO ROUNDS | |
| | WEAPONS FREE | |
| | WEAPONS FREE | |
| EXECUTION | ENGAGE UPON POSITIVE IDENTIFICATION | Sniper is free to engage. |
| TERMINATION | CEASE FIRE | |
| | CEASE FIRE | |
| WEAPONS SAFETY STATUS RED | | |
| UPON COMPLETION OF THE ENGAGEMENT, THE TOWER DIRECTS THE SNIPER TEAM TO FIRING POSITION B – NORTH AMERICAN OR EUROPEAN ROOM AND REPORT SET. | | |
| SNIPER TEAMS HAVE FOUR MINUTES FROM ACKNOWLEDGING TO REPORT SET IN FIRING POSITION B | | |
| Legend: TRP - target reference point | | |

Table G-94. Sniper weapons, Table VI, stage 1, day fire, engagement 3, conduct of fire example

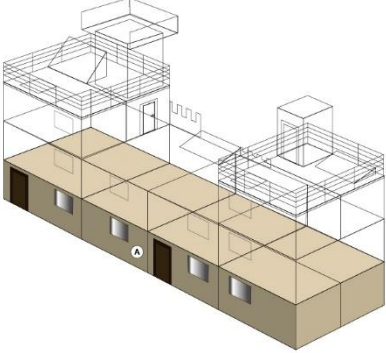

| <i>Table VI, Engagement 3 – North American / European, Known Distance</i> | | |
|--|---|---|
| Firing Position | M110 / M2010 Target | M107 Target |
|  |  |  |
| | 600 meters | 900 meters |
| Element | Tower Prompt | Remarks |
| WEAPONS SAFETY STATUS RED | | |
| ALERT | SIERRA TANGO (ONE) | |
| TARGET DESCRIPTION | INSURGENT / DRIVER | |
| DIRECTION | TRP _____ | |
| CONTROL | TWO ROUNDS WEAPONS FREE WEAPONS FREE | |
| EXECUTION | ENGAGE UPON POSITIVE IDENTIFICATION | Sniper is free to engage. |
| TERMINATION | CEASE FIRE CEASE FIRE | |
| WEAPONS SAFETY STATUS RED | | |
| UPON COMPLETION OF THE ENGAGEMENT, THE TOWER DIRECTS THE SNIPER TEAM TO: FIRING POSITION C – SOUTHWEST ASIA OR AFRICAN ROOM AND REPORT SET. | | |
| SNIPER TEAMS HAVE FOUR MINUTES FROM ACKNOWLEDGING TO REPORT SET IN FIRING POSITION C | | |
| Legend: TRP - target reference point | | |

Table G-95. Sniper weapons, Table VI, stage 1, day fire, engagement 4, conduct of fire example

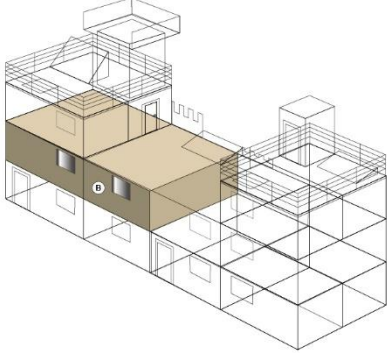

| <i>Table VI, Engagement 4 – Southwest Asia / Africa, Unknown Distance</i> | | |
|---|--|---|
| Firing Position | M110 / M2010 Target | M107 Target |
|  |  TMT-I, STATIONARY 400 to 600 meters |  ENGINE 600 to 800 meters |
| Element | Tower Prompt | Remarks |
| WEAPON SAFETY STATUS RED | | |
| ALERT | SIERRA TANGO (ONE) | |
| TARGET DESCRIPTION | INSURGENT / FLEEING INSURGENT | |
| DIRECTION | TRP _____ | |
| CONTROL | TWO ROUNDS (IMMOBILIZE THE VEHICLE) WEAPONS FREE WEAPONS FREE | |
| EXECUTION | ENGAGE UPON POSITIVE IDENTIFICATION | Sniper is free to engage. |
| TERMINATION | CEASE FIRE CEASE FIRE | |
| WEAPONS SAFETY STATUS RED | | |
| UPON COMPLETION OF THE ENGAGEMENT, THE TOWER DIRECTS THE SNIPER TEAM TO: FIRING POSITION D – BLACKOUT ROOM AND REPORT SET. | | |
| SNIPER TEAMS HAVE FOUR MINUTES FROM ACKNOWLEDGING TO REPORT SET IN FIRING POSITION D. | | |
| Legend: TMT-I – trackless moving targets–Infantry, TRP - target reference point | | |

Table G-96. Sniper weapons, Table VI, stage 1, day fire, engagement 5, conduct of fire example

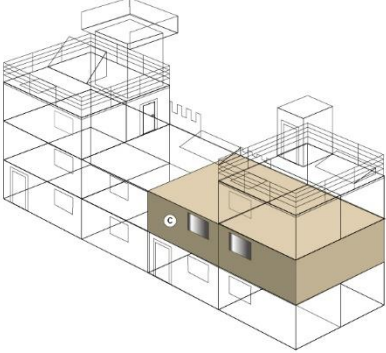

| Table VI, Engagement 5 – Blacked-out Room, Unknown Distance | | |
|--|--|--|
| Firing Position | M110 / M2010 Target | M107 Target |
|  |  TMT-I, MOVING 400 to 600 meters |  TMT-V, MOVING, DRIVER 1200 to 1300 meters |
| Element | Tower Prompt | Remarks |
| WEAPONS SAFETY STATUS RED | | |
| ALERT | SIERRA TANGO (ONE) | |
| TARGET DESCRIPTION | FLEEING INSURGENT (DRIVER) | |
| DIRECTION | TRP _____ | |
| CONTROL | TWO ROUNDS WEAPONS FREE WEAPONS FREE | |
| EXECUTION | ENGAGE UPON POSITIVE IDENTIFICATION | Sniper is free to engage. |
| TERMINATION | CEASE FIRE CEASE FIRE | |
| WEAPONS SAFETY STATUS RED | | |
| UPON COMPLETION OF THE ENGAGEMENT, THE TOWER DIRECTS THE SNIPER TEAM TO: FIRING POSITION E – LOW PARAPET AND REPORT SET. | | |
| SNIPER TEAMS HAVE FOUR MINUTES FROM ACKNOWLEDGING TO REPORT SET IN FIRING POSITION E. | | |
| Legend: TMT-I – trackless moving targets-Infantry, TMT-V – trackless moving targets–vehicle, TRP - target reference point | | |

Table G-97. Sniper weapons, Table VI, stage 1, day fire, engagement 6, conduct of fire example

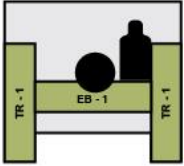

| Table VI, Engagement 6 – Low Parapet, Unknown Distance | | |
|---|--|--|
| Firing Position | M110 / M2010 Target | M107 Target |
|  |  TMT-I, MOVING 500 to 700 meters |  TMT-V, MOVING, DRIVER 1400 to 1600 meters |
| Element | Tower Prompt | Remarks |
| WEAPON SAFETY STATUS RED | | |
| ALERT | SIERRA TANGO (ONE) | |
| TARGET DESCRIPTION | INBOUND HIGH VALUE TARGET (DRIVER) | |
| DIRECTION | TRP _____ | |
| CONTROL | TWO ROUNDS WEAPONS FREE WEAPONS FREE | |
| EXECUTION | ENGAGE UPON POSITIVE IDENTIFICATION | Sniper is free to engage. |
| TERMINATION | CEASE FIRE CEASE FIRE | |
| WEAPONS SAFETY STATUS RED | | |
| UPON COMPLETION OF THE ENGAGEMENT, THE TOWER DIRECTS THE SNIPER TEAM TO: FIRING POSITION E – 6:12 PITCH ROOF AND REPORT SET. | | |
| SNIPER TEAMS HAVE FOUR MINUTES FROM ACKNOWLEDGING TO REPORT SET IN FIRING POSITION E. | | |
| Legend: TMT-I – trackless moving targets-Infantry, TMT-V – trackless moving targets–vehicle, TRP - target reference point | | |

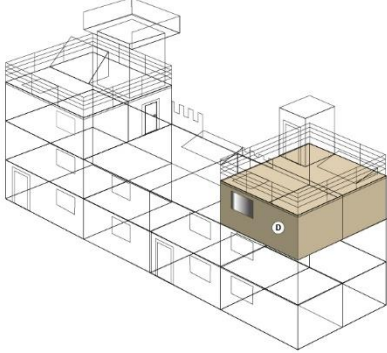
Table G-98. Sniper weapons, Table VI, stage 1, day fire, engagement 7, conduct of fire example

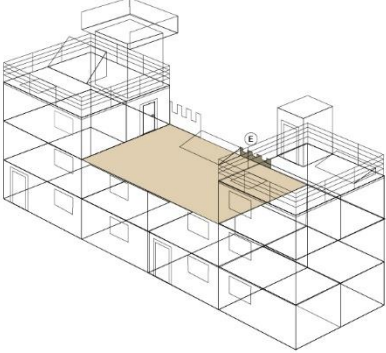

| Table VI, Engagement 7 – 6:12 Pitch Roof, Unknown Distance | | |
|--|--|--|
| Firing Position | M110 / M2010 Target | M107 Target |
|  |  TMT-I, MOVING 600 to 800 meters |  TMT-V, MOVING, DRIVER 1200 to 1300 meters |
| Element | Tower Prompt | Remarks |
| WEAPON SAFETY STATUS RED | | |
| ALERT | SIERRA TANGO (ONE) | |
| TARGET DESCRIPTION | MOVING TROOP (DRIVER) | |
| DIRECTION | TRP ____ | |
| CONTROL | TWO ROUNDS WEAPONS FREE WEAPONS FREE | |
| EXECUTION | ENGAGE UPON POSITIVE IDENTIFICATION | Sniper is free to engage. |
| TERMINATION | CEASE FIRE CEASE FIRE | |
| WEAPONS SAFETY STATUS RED | | |
| UPON COMPLETION OF THE ENGAGEMENT, THE TOWER DIRECTS THE SNIPER TEAM TO: FIRING POSITION F – BRIGHT ROOM AND REPORT SET. | | |
| SNIPER TEAMS HAVE FOUR MINUTES FROM ACKNOWLEDGING TO REPORT SET IN FIRING POSITION F. | | |
| Legend: TMT-I – trackless moving targets-Infantry, TMT-V – trackless moving targets–vehicle, TRP - target reference point | | |

Table G-99. Sniper weapons, Table VI, stage 1, day fire, engagement 8, conduct of fire example

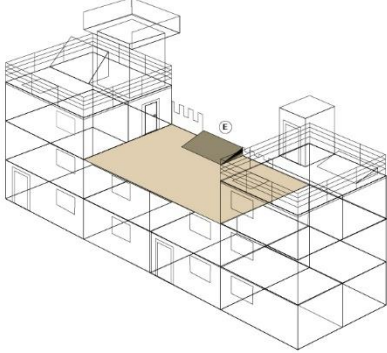

| <i>Table VI, Engagement 8 – Bright Room, Unknown Distance</i> | | |
|--|--|--|
| Firing Position | M110 / M2010 Target | M107 Target |
|  |  TMT-I, MOVING 300 to 500 meters |  TMT-V, MOVING, ENGINE 1400 to 1600 meters |
| Element | Tower Prompt | Remarks |
| WEAPON SAFETY STATUS RED | | |
| ALERT | SIERRA TANGO (ONE) | |
| TARGET DESCRIPTION | FLEEING HIGH VALUE TARGET | |
| DIRECTION | TRP _____ | |
| CONTROL | TWO ROUNDS (IMMOBILIZE VEHICLE) | |
| | WEAPONS FREE WEAPONS FREE | |
| EXECUTION | ENGAGE UPON POSITIVE IDENTIFICATION | Sniper is free to engage. |
| TERMINATION | CEASE FIRE CEASE FIRE | |
| WEAPONS SAFETY STATUS RED | | |
| UPON COMPLETION OF THE ENGAGEMENT, THE TOWER DIRECTS THE SNIPER TEAM TO: FIRING POSITION G – 12:12 PITCH ROOF AND REPORT SET. | | |
| SNIPER TEAMS HAVE FOUR MINUTES FROM ACKNOWLEDGING TO REPORT SET IN FIRING POSITION G. | | |
| Legend: TMT-I – trackless moving targets-Infantry, TMT-V – trackless moving targets-vehicle, TRP - target reference point | | |

Table G-100. Sniper weapons, Table VI, stage 1, day fire, engagement 9, conduct of fire example



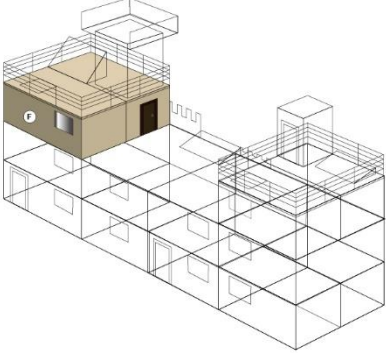

| <i>Table VI, Engagement 9 – 12:12 Pitch Roof, Unknown Distance</i> | | |
|--|--|--|
| Firing Position | M110 / M2010 Target | M107 Target |
|  |  TMT-I, EVASIVE |  TMT-V, EVASIVE, ENGINE |
| | 400 to 600 meters (M110) 800 to 1000 meters (M2010) | 1200 to 1400 meters |
| Element | Tower Prompt | Remarks |
| WEAPON SAFETY STATUS RED | | |
| ALERT | SIERRA TANGO (ONE) | |
| TARGET DESCRIPTION | INSURGENTS MOVING INTO SECTOR | |
| DIRECTION | TRP _____ | |
| CONTROL | TWO ROUNDS (IMMOBILIZE ENGINE) WEAPONS FREE WEAPONS FREE | |
| EXECUTION | ENGAGE UPON POSITIVE IDENTIFICATION | Sniper is free to engage. |
| TERMINATION | CEASE FIRE CEASE FIRE | |
| WEAPONS SAFETY STATUS RED | | |
| UPON COMPLETION OF THE ENGAGEMENT, THE TOWER DIRECTS THE SNIPER TEAM TO: FIRING POSITION G – PARAPET AND REPORT SET. | | |
| SNIPER TEAMS HAVE FOUR MINUTES FROM ACKNOWLEDGING TO REPORT SET IN FIRING POSITION G. | | |
| Legend: TMT-I – trackless moving targets-Infantry, TMT-V – trackless moving targets–vehicle, TRP - target reference point | | |

Table G-101. Sniper weapons, Table VI, stage 1, day fire, engagement 10, conduct of fire example

| <i>Table VI, Engagement 10 – Parapet, 30-inch, Unknown Distance</i> | | |
|--|--|---|
| Firing Position | M110 / M2010 Target | M107 Target |
|  |  TMT-I, EVASIVE 600 to 800 meters (M110) 800 to 1000 meters (M2010) |  TMT-V, EVASIVE, DRIVER 1400 to 1600 meters |
| Element | Tower Prompt | Remarks |
| WEAPON SAFETY STATUS | | |
| ALERT | SIERRA TANGO (ONE) | |
| TARGET DESCRIPTION | FLEEING INSURGENT (DRIVER) | |
| DIRECTION | TRP _____ | |
| CONTROL | TWO ROUNDS WEAPONS FREE WEAPONS FREE | |
| EXECUTION | ENGAGE UPON POSITIVE IDENTIFICATION | Sniper is free to engage. |
| TERMINATION | CEASE FIRE CEASE FIRE | |
| WEAPONS SAFETY STATUS RED | | |
| AT THE COMPLETION OF THIS ENGAGEMENT, TOWER REQUESTS A SITUATION REPORT WITH ROUNDS EXPENDED. | | |
| ONCE SNIPER TEAM REPORTS, TOWER CONTINUES. | | |
| Legend: TMT-I – trackless moving targets-Infantry, TMT-V – trackless moving targets–vehicle, TRP - target reference point | | |

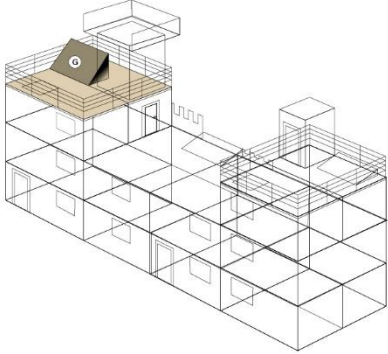
G-128. A lane safety clears the firers upon their completion of Table VI and collecting their dunnage. A lane safety verifies the clearing prior to the Soldier moving from the firing point. Once the lane safety clears all the Soldiers, the lane safety communicates the WSS to the tower operator. The tower operator issues an administrative command to move the completed Soldiers off the range. Table G-102 is an example of this command.

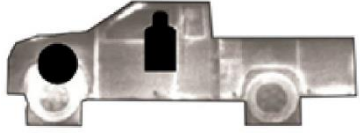
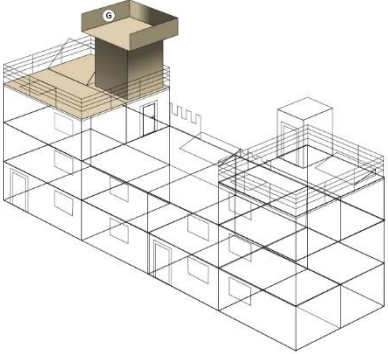
Table G-102. Table VI, completed firing order, conduct of the range example

| <i>Firing Order Complete</i> | | | |
|--|--|--|----------------|
| FIRING ORDER COMPLETE | Task | Target | Target Type |
| | Completed Firing Order | N/A | N/A |
| | Rounds per Target | DODIC | Time (Seconds) |
| | N/A | N/A | NO LIMIT |
| TOWER | | SOLDIER ACTION | |
| WEAPON SAFETY STATUS RED | | | |
| WEAPONS SAFETY STATUS GREEN | GO GREEN GO GREEN ONCE VERIFIED BY THE RSO, SECURE WEAPON | Soldiers clear their weapon and wait to be inspected by a lane safety. | |
| CONDUCT OF THE RANGE | SNIPERS SECURE YOUR DUNNAGE MOVE TO THE BASELINE. | Firers secure weapon and ammunition dunnage and move to the designated location. | |
| ONCE ALL SNIPERS RETURN TO THE BASELINE, TOWER DIRECTS THE FIRING ORDER OFF THE RANGE. | | | |
| Legend: DODIC – Department of Defense identification code, N/A – not applicable, RSO – range safety officer | | | |

G-129. As soon as the lane safety clears the completed firing order, the tower operator moves a new firing order into position and the process repeats itself until all firers have completed Table VI, Qualification, successfully. Any identified firers that require retraining move to the appropriate training location.

SNIPER WEAPON SYSTEMS, TABLE VI, STAGE 2, NIGHT FIRE, ASSISTED

G-130. Table VI consists of two separate stages in the course of fire. The stages used during Table VI are—

- Stage 1 – Day Fire.
- Stage 2 – Night Fire, Assisted (pointer, illuminator, and thermal).

G-131. Soldiers must successfully finish both course of fire stages to complete the course of fire. The following paragraphs describe the course of fire for Table VI, Stage 2, Night Fire, Assisted.

SCENARIO ENGAGEMENTS

G-132. Targets are presented to the sniper in single target arrays. Targets are presented such that 90-percent of the target is clearly visible to the sniper from the expected or planned firing position. Targets are exposed to the sniper based on the target's tactical posture presented during the engagement as follows:

- Stationary target engagements are exposed for 30 seconds.
- Moving target engagements are exposed for 45 seconds.
- Evasive target engagements are exposed for 60 seconds.

G-133. The sniper and spotter have three minutes to establish their firing position and report SET to the sniper team leader after each engagement. During the transition period to the next engagement or firing position, the sniper and spotter are responsible to reload as appropriate, update their sketch card, and establish the best prone supported firing position overlooking the directed target area. Tables G-103 through G-105, pages G-111 through G-113, show the scenario engagement sequence for Table VI, Stage 2, Night Fire, Assisted.

Table G-103. M110 sniper rifle, Table VI, Qualification, Stage 2, Night Fire, Assisted, engagement sequence

| <i>M110 Sniper Weapon System Engagements, Stage 2, Night Fire, Assisted</i> | | | | | | | |
|---|--|-----------|---------------|-----------------------|--------------|---------------|-----------------------------|
| <i>ENG</i> | <i>Task or Capability</i> | <i>FP</i> | <i>Target</i> | <i>Target Posture</i> | <i>M110</i> | <i>Rounds</i> | <i>Target Exposure Time</i> |
| 0 | Sketch card and cold bore | A | A-8 | STA | 200m | 1 | 10 minutes |
| 1 | Laser, known distance | A | E-type | STA | 200m | 2 | 30 seconds |
| 2 | Laser, known distance | A | E-type | STA | 100m | 2 | 30 seconds |
| 3 | Laser, North America or Europe, known distance | B | E-type | STA | 300m | 2 | 30 seconds |
| 4 | SWA or African, unknown distance | C | TMT-I | STA | 400m to 600m | 2 | 30 seconds |
| 5 | Blacked-out room, unknown distance | D | TMT-I | MOV | 400m to 600m | 2 | 35 seconds |
| 6 | Low parapet, unknown distance | E | TMT-I | MOV | 500m to 700m | 2 | 35 seconds |
| 7 | 6:12 pitch, unknown distance | E | TMT-I | MOV | 600m to 800m | 2 | 35 seconds |
| 8 | Bright room, unknown distance | F | TMT-I | MOV | 300m to 500m | 2 | 35 seconds |
| 9 | 12:12 pitch, unknown distance | G | TMT-I | EVA | 400m to 600m | 2 | 40 seconds |
| 10 | Parapet, unknown distance | G | TMT-I | EVA | 600m to 800m | 2 | 40 seconds |
| <p>Note. This course of fire is based on the capabilities of the automated sniper field fire (SFF) range or comparable facility. If the primary facility is not available, the unit should refer to the modified course of fire (known as MCOF).</p> | | | | | | | |
| <p>Legend: ENG – engagement, EVA – evasive target, FP – firing point, m – meter, MOV – moving target, SWA – Southwest Asia, STA – stationary target, TMT-I – trackless moving targets-Infantry</p> | | | | | | | |

Table G-104. M2010 sniper rifle, Table VI, Qualification, Stage 2, Night Fire, Assisted, engagement sequence

| <i>M2010 Sniper Weapon System Engagements, Stage 2, Night Fire, Assisted</i> | | | | | | | |
|---|--|-----------|---------------|-----------------------|----------------------|---------------|-----------------------------|
| <i>ENG</i> | <i>Task or Capability</i> | <i>FP</i> | <i>Target</i> | <i>Target Posture</i> | <i>M2010</i> | <i>Rounds</i> | <i>Target Exposure Time</i> |
| 0 | Sketch card and cold bore | A | A-8 | STA | 200m | 1 | 10 minutes |
| 1 | Laser, known distance | A | E-type | STA | 200m | 2 | 30 seconds |
| 2 | Laser, known distance | A | E-type | STA | 100m | 2 | 30 seconds |
| 3 | Laser, North America or Europe, known distance | B | E-type | STA | 300m | 2 | 30 seconds |
| 4 | SWA or African, unknown distance | C | TMT-I | STA | 400m to 600m | 2 | 30 seconds |
| 5 | Blacked-out room, unknown distance | D | TMT-I | MOV | 400m to 600m | 2 | 35 seconds |
| 6 | Low parapet, unknown distance | E | TMT-I | MOV | 500m to 700m | 2 | 35 seconds |
| 7 | 6:12 pitch, unknown distance | E | TMT-I | MOV | 600m to 800m | 2 | 35 seconds |
| 8 | Bright room, unknown distance | F | TMT-I | MOV | 300m to 500m | 2 | 35 seconds |
| 9 | 12:12 pitch, unknown distance | G | TMT-I | EVA | 800m to 1000m | 2 | 40 seconds |
| 10 | Parapet, unknown distance | G | TMT-I | EVA | 800m to 1000m | 2 | 40 seconds |
| <p>Note. This course of fire is based on the capabilities of the automated sniper field fire (SFF) range or comparable facility. If the primary facility is not available, the unit should refer to the Modified Course of Fire (known as MCOF).</p> | | | | | | | |
| <p>Legend: ENG – engagement, EVA – evasive target, FP – firing point, m – meter, MOV – moving target, SWA – Southwest Asia, STA – stationary target, TMT-I – trackless moving targets-Infantry</p> | | | | | | | |

Table G-105. M107 sniper rifle, Table VI, Qualification, Stage 2, Night Fire, Assisted, engagement sequence

| <i>M107 Sniper Weapon System Engagements, Stage 2, Night Fire, Assisted,</i> | | | | | | | |
|--|---|-----------|----------------------------|-----------------------|----------------------|---------------|-----------------------------|
| <i>ENG</i> | <i>Task or Capability</i> | <i>FP</i> | <i>Target</i> | <i>Target Posture</i> | <i>M2010</i> | <i>Rounds</i> | <i>Target Exposure Time</i> |
| 0 | Sketch card and cold bore | A | A-8 | STA | 200m | 1 | 10 minutes |
| 1 | Reconfigurable, known distance | A | E-type | STA | 600m | 2 | 30 seconds |
| 2 | Reconfigurable, known distance | A | E-type | STA | 400m | 2 | 30 seconds |
| 3 | North America or Europe, known distance | B | L3T-FRT TMT-V Driver | STA | 900m | 2 | 30 seconds |
| 4 | SWA or African, unknown distance | C | L2T-FRT TMT-V Engine | STA | 600m to 800m | 2 | 30 seconds |
| 5 | Blacked-out room, unknown distance | D | L2T-FLK TMT-V Driver | MOV | 1200m to 1300m | 2 | 35 seconds |
| 6 | Low parapet, unknown distance | E | L3T-FLK TMT-V Driver | MOV | 1400m to 1600m | 2 | 35 seconds |
| 7 | 6:12 pitch, unknown distance | E | L2T-FLK TMT-V Driver | MOV | 1200m to 1300m | 2 | 35 seconds |
| 8 | Bright room, unknown distance | F | L3T-FLK TMT-V Engine | MOV | 1400m to 1600m | 2 | 35 seconds |
| 9 | 12:12 pitch, Unknown Distance | G | L2T-FLK TMT-V Engine | EVA | 1200m to 1400m | 2 | 40 seconds |
| 10 | Parapet, unknown distance | G | L3T-FLK TMT-V Driver | EVA | 1400m to 1600m | 2 | 40 seconds |
| <p>Note. This course of fire is based on the capabilities of the heavy sniper range (HSR) or comparable facility. If the primary facility is not available, the unit should refer to the modified course of fire (known as MCOF).</p> | | | | | | | |
| <p>Legend: ENG – engagement, EVA – evasive target, FP – firing point, m – meter, MOV – moving target, SWA – Southwest Asia, STA – stationary target, TMT-V – trackless moving targets-vehicle</p> | | | | | | | |

G-134. Table G-106 provides the Table VI, Qualification, Stage 2, Night Fire, Assisted, throughput schedule. It is a guide to units that portrays the overall efficiency of the range facility when conducting the training event. Table G-106 provides the overall throughput timetable, based on the time the unit requires to remove one firing order from the firing positions and move the next firing order forward.

Table G-106. Sniper rifle, Table VI, Qualification, Stage 2, Night Fire, Assisted, throughput time schedule

| <i>Phase</i> | <i>Time to Execute</i> | <i>Remarks</i> | |
|---|----------------------------------|--|-----------------------|
| Stationary Targets | 18:00 minutes | Sketch card and cold bore are conducted as the sniper team awaits the tower instructions to the first firing point. Does not include administrative time to exit or enter the sniper teams to their designated start position. | |
| Moving Targets | 19:00 minutes | | |
| Evasive Targets | 10:00 minutes | | |
| Total Time Per Firing Order | 42:00 minutes | | |
| <i>Firing Orders</i> | <i>Simultaneous Sniper Teams</i> | | |
| | <i>1 Sniper Team</i> | <i>2 Sniper Teams</i> | <i>3 Sniper Teams</i> |
| 2 | 1 hr 24 min | 4 | 6 |
| 3 | 2 hrs 6 min | 6 | 9 |
| 4 | 2 hrs 48 min | 8 | 12 |
| 5 | 3 hrs 30 min | 10 | 15 |
| 6 | 4 hrs 12 min | 12 | 18 |
| 7 | 4 hrs 54 min | 14 | 21 |
| 8 | 5 hrs 36 min | 16 | 24 |
| 9 | 6 hrs 18 min | 18 | 27 |
| 10 | 7 hrs 0 min | 20 | 30 (ABCT) |
| 11 | 7 hrs 42 min | 22 | 33 |
| 12 | 8 hrs 24 min | 24 | 36 |
| 13 | 9 hrs 6 min | 26 | 39 (IBCT) |
| 14 | 9 hrs 48 min | 28 | 42 |
| 15 | 10 hrs 30 min | 30 (ABCT) | 45 |
| 16 | 11 hrs 12 min | 32 | 48 (SBCT) |
| 17 | 11 hrs 54 min | 34 | |
| 18 | 12 hrs 36 min | 36 | |
| Snipers per BCT Type: | ABCT = 30 | IBCT = 37 | SBCT = 48 |
| Legend: ABCT – Armor brigade combat team, BCT – brigade combat team, hr – hour, hrs – hours, IBCT – Infantry brigade combat team, min – minute, SBCT – Stryker brigade combat team | | | |

CONDUCT OF THE RANGE

G-135. Leaders instruct snipers on the objectives of Table VI, Qualification, Stage 2, Night Fire, Assisted, and the importance of the functional elements of the shot process. Table VI, Qualification, Stage 2, Night Fire, Assisted contains 11 firing tasks with an administrative pause programmed at the end of each engagement to facilitate change of firing positions.

G-136. Snipers enter the range and move to their firing points. Once at the firing point, firers assume a prone supported firing position with weapons in a green status. Firers fire Table VI from the ready at varying firing positions throughout the duration of the course of fire. The sniper teams will conduct the course of fire so that—

- Task 0, sketch card and cold bore shot, is completed prior to conducting the scored engagements.
- All engagements in the scored events are fired from positions established by the sniper using available equipment, attachments, or surrounding items.
- First round hits receive 10 points.
- Second round hits receive 5 points.
- No points are awarded for hits beyond the second round or for targets not hit.

G-137. Firers must score a minimum of 140 of 200 points (70 percent) on the ten engagements presented to pass this event with a minimum of 70 points in stage 1 and 70 points in stage 2. It is not required for Soldiers to complete this table before conducting Table VI. This event is purposefully more rigorous than the qualification event where the targets are presented in a rapid tempo, and the time to transition between firing positions and tactical reloading are reduced. Leaders annotate the official record of training on DA Form 7811.

G-138. Snipers begin Table VI by moving into the firing position following administrative commands from the tower operator. Tower operators use administrative commands to control the flow of the range, movement of personnel, and other command and control purposes. Table G-107 provides an example of the administrative commands for moving a new firing order into position.

Table G-107. Table VI, new firing order, conduct of the range example

| <i>New Firing Order, Conduct of the Range</i> | | | |
|--|---|---|-----------------------|
| | Task | Target | Target Type |
| SKETCH CARD AND COLD BORE SHOT PREPARATION | New Firing Order | N/A | N/A |
| | Rounds per Target | DODIC | Time (Seconds) |
| | N/A | AA11 (M110) A191 (M2010) A552 (M107) | NO LIMIT |
| TOWER | | SNIPER ACTION | |
| CONDUCT OF THE RANGE | SECURE YOUR AMMUNITION AND MOVE TO YOUR FIRING POINT | Snipers secure their weapon in a GREEN status, their training ammunition and move to the designated firing point. | |
| ONCE ALL SNIPERS AND SPOTTERS ARE COMPLETE, CONDUCT OF THE RANGE CONTINUES. | | | |
| Legend: DODIC – Department of Defense identification code, N/A – not applicable | | | |

G-139. Once the snipers are in the initial fighting position, they complete their sketch card and engagement 0, cold bore through coordination with the tower operator, as shown in table G-108. This firing position should be separated from those snipers negotiating the course of fire, with all shots controlled and authorized by the tower operator.

Table G-108. Table IV, engagement 0, cold bore, conduct of fire example

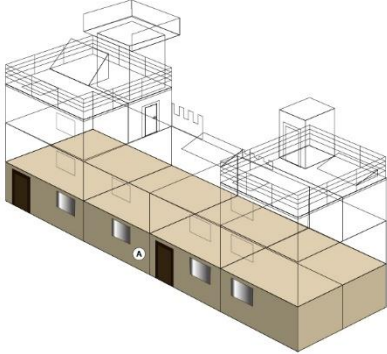
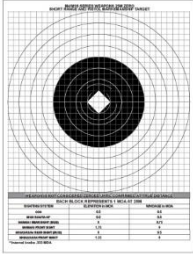
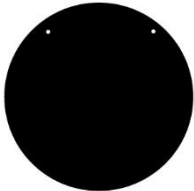
| <i>Table VI, Engagement 0 – Cold Bore</i> | | |
|---|---|--|
| Firing Position | M110 / M2010 Target | M107 Target |
|  |  |  |
| | 200 meters | OR 10 inch Steel Plate 200 meters |
| Element | Tower Prompt | Remarks |
| WEAPONS SAFETY STATUS RED | GO TO PRONE MAKE READY | Sniper establishes a PRONE SUPPORTED position and loads the appropriate ammunition. |
| ALERT | SIERRA TANGO (ONE) | |
| TARGET DESCRIPTION | COLD BORE | |
| DIRECTION | TRP _____ | |
| RANGE | TWO-HUNDRED | |
| CONTROL | ONE ROUND | |
| | WEAPONS FREE WEAPONS FREE | |
| EXECUTION | ENGAGE UPON POSITIVE IDENTIFICATION | Sniper is free to engage. |
| TERMINATION | CEASE FIRE CEASE FIRE | |
| WEAPONS SAFETY STATUS RED | | |
| ONCE COMPLETE, SNIPERS REPORT SET AND AWAIT INSTRUCTIONS FROM THE TOWER. | | |
| Legend: TRP - target reference point | | |

G-140. The following engagement sequence guide initiates the Table VI scenario. The tables G-109 through G-118, on pages G-117 through G-126 engagement sequence with a generic conduct of fire process for the tower operator.

Table G-109. Sniper weapons, Table VI, Qualification, Stage 2, Night Fire, Assisted, engagement 1, conduct of fire example



| <i>Table VI, Engagement 1 – Reconfigurable, Known Distance</i> | | |
|--|---|---|
| Firing Position | M110 / M2010 Target | M107 Target |
|  |  |  |
| | 200 meters | 600 meters |
| Element | Tower Prompt | Remarks |
| WEAPON SAFETY STATUS (UNIT MAY HAVE PLACED SNIPERS IN A GREEN STATUS AWAITING THEIR FIRING ORDER) | | |
| ALERT | SIERRA TANGO (ONE) | |
| TARGET DESCRIPTION | TROOP | |
| DIRECTION | TRP _____ | |
| CONTROL | TWO ROUNDS (LASER) WEAPONS FREE WEAPONS FREE | Laser for M110 and M2010 ONLY. |
| EXECUTION | ENGAGE UPON POSITIVE IDENTIFICATION | Sniper is free to engage. |
| TERMINATION | CEASE FIRE CEASE FIRE | |
| WEAPONS SAFETY STATUS RED | | |
| SNIPERS AWAIT COMMANDS FROM THE TOWER TO CONTINUE IN A RED STATUS. | | |
| SNIPERS ARE PROVIDED NO MORE THAN FOUR MINUTES BETWEEN ENGAGEMENTS. | | |
| Legend: TRP - target reference point | | |

Table G-110. Sniper weapons, Table VI, Qualification, Stage 2, Night Fire, Assisted, engagement 2, conduct of fire example

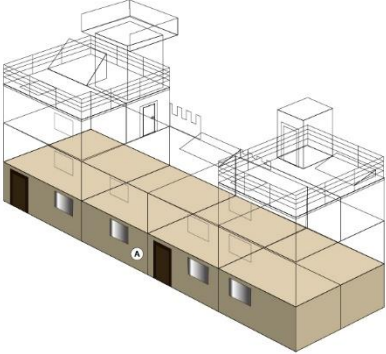

| <i>Table VI, Engagement 2 – Reconfigurable, Known Distance</i> | | |
|--|---|---|
| Firing Position | M110 / M2010 Target | M107 Target |
|  |  |  |
| | 100 meters | 400 meters |
| Element | Tower Prompt | Remarks |
| WEAPONS SAFETY STATUS RED | | |
| ALERT | SIERRA TANGO (ONE) | |
| TARGET DESCRIPTION | HIGH VALUE TARGET | |
| DIRECTION | TRP _____ | |
| CONTROL | TWO ROUNDS (LASER) | Laser for M110 and M2010 ONLY. |
| | WEAPONS FREE WEAPONS FREE | |
| EXECUTION | ENGAGE UPON POSITIVE IDENTIFICATION | Sniper is free to engage. |
| TERMINATION | CEASE FIRE CEASE FIRE | |
| WEAPONS SAFETY STATUS RED | | |
| UPON COMPLETION OF THE ENGAGEMENT, THE TOWER DIRECTS THE SNIPER TEAM TO FIRING POSITION B – NORTH AMERICAN OR EUROPEAN ROOM AND REPORT SET. | | |
| SNIPER TEAMS HAVE FOUR MINUTES FROM ACKNOWLEDGING TO REPORT SET IN FIRING POSITION B | | |
| Legend: TRP - target reference point | | |

Table G-111. Sniper weapons, Table VI, Qualification, Stage 2, Night Fire, Assisted, engagement 3, conduct of fire example

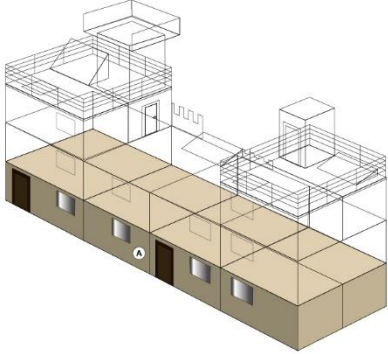

| <i>Table VI, Engagement 3 – North American / European, Known Distance</i> | | |
|--|---|---|
| Firing Position | M110 / M2010 Target | M107 Target |
|  |  |  |
| | 300 meters | 900 meters |
| Element | Tower Prompt | Remarks |
| WEAPONS SAFETY STATUS RED | | |
| ALERT | SIERRA TANGO (ONE) | |
| TARGET DESCRIPTION | INSURGENT / DRIVER | |
| DIRECTION | TRP _____ | |
| CONTROL | TWO ROUNDS (LASER) WEAPONS FREE WEAPONS FREE | Laser for M110 and M2010 ONLY. |
| EXECUTION | ENGAGE UPON POSITIVE IDENTIFICATION | Sniper is free to engage. |
| TERMINATION | CEASE FIRE CEASE FIRE | |
| WEAPONS SAFETY STATUS RED | | |
| UPON COMPLETION OF THE ENGAGEMENT, THE TOWER DIRECTS THE SNIPER TEAM TO: FIRING POSITION C – SOUTHWEST ASIA OR AFRICAN ROOM AND REPORT SET. | | |
| SNIPER TEAMS HAVE FOUR MINUTES FROM ACKNOWLEDGING TO REPORT SET IN FIRING POSITION C. | | |
| Legend: TRP - target reference point | | |

Table G-112. Sniper weapons, Table VI, Qualification, Stage 2, Night Fire, Assisted, engagement 4, conduct of fire example

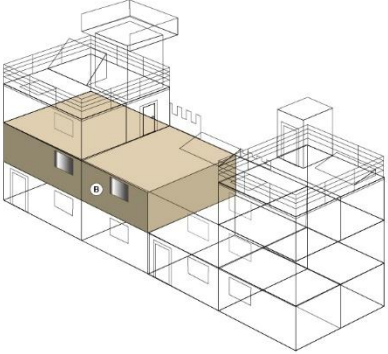

| <i>Table VI, Engagement 4 – Southwest Asia / Africa, Unknown Distance</i> | | |
|---|--|---|
| Firing Position | M110 / M2010 Target | M107 Target |
|  |  TMT-I, STATIONARY 400 to 600 meters |  ENGINE 600 to 800 meters |
| Element | Tower Prompt | Remarks |
| WEAPON SAFETY STATUS RED | | |
| ALERT | SIERRA TANGO (ONE) | |
| TARGET DESCRIPTION | INSURGENT / FLEEING INSURGENT | |
| DIRECTION | TRP _____ | |
| CONTROL | TWO ROUNDS (IMMOBILIZE THE VEHICLE) WEAPONS FREE WEAPONS FREE | |
| EXECUTION | ENGAGE UPON POSITIVE IDENTIFICATION | Sniper is free to engage. |
| TERMINATION | CEASE FIRE CEASE FIRE | |
| WEAPONS SAFETY STATUS RED | | |
| UPON COMPLETION OF THE ENGAGEMENT, THE TOWER DIRECTS THE SNIPER TEAM TO: FIRING POSITION D – BLACKOUT ROOM AND REPORT SET. | | |
| SNIPER TEAMS HAVE FOUR MINUTES FROM ACKNOWLEDGING TO REPORT SET IN FIRING POSITION D. | | |
| Legend: TMT-I – trackless moving targets–Infantry, TRP - target reference point | | |

Table G-113. Sniper weapons, Table VI, Qualification, Stage 2, Night Fire, Assisted, engagement 5, conduct of fire example

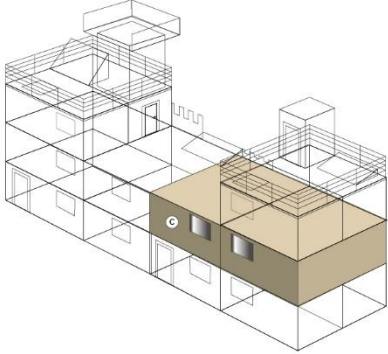

| <i>Table VI, Engagement 5 – Blacked-Out Room, Unknown Distance</i> | | |
|--|--|--|
| Firing Position | M110 / M2010 Target | M107 Target |
|  |  TMT-I, MOVING 400 to 600 meters |  TMT-V, MOVING, DRIVER 1200 to 1300 meters |
| Element | Tower Prompt | Remarks |
| WEAPONS SAFETY STATUS RED | | |
| ALERT | SIERRA TANGO (ONE) | |
| TARGET DESCRIPTION | FLEEING INSURGENT (DRIVER) | |
| DIRECTION | TRP _____ | |
| CONTROL | TWO ROUNDS WEAPONS FREE WEAPONS FREE | |
| EXECUTION | ENGAGE UPON POSITIVE IDENTIFICATION | Sniper is free to engage. |
| TERMINATION | CEASE FIRE CEASE FIRE | |
| WEAPONS SAFETY STATUS RED | | |
| UPON COMPLETION OF THE ENGAGEMENT, THE TOWER DIRECTS THE SNIPER TEAM TO: FIRING POSITION E – LOW PARAPET AND REPORT SET. | | |
| SNIPER TEAMS HAVE FOUR MINUTES FROM ACKNOWLEDGING TO REPORT SET IN FIRING POSITION E. | | |
| Legend: TMT-I – trackless moving targets–Infantry, TMT-V – trackless moving targets–vehicle, TRP - target reference point | | |

Table G-114. Sniper weapons, Table VI, Qualification, Stage 2, Night Fire, Assisted, engagement 6, conduct of fire example

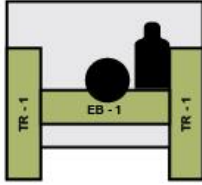

| <i>Table VI, Engagement 6 – Low Parapet, Unknown Distance</i> | | |
|---|--|--|
| Firing Position | M110 / M2010 Target | M107 Target |
|  |  TMT-I, MOVING 500 to 700 meters |  TMT-V, MOVING, DRIVER 1400 to 1600 meters |
| Element | Tower Prompt | Remarks |
| WEAPON SAFETY STATUS RED | | |
| ALERT | SIERRA TANGO (ONE) | |
| TARGET DESCRIPTION | INBOUND HIGH VALUE TARGET (DRIVER) | |
| DIRECTION | TRP _____ | |
| CONTROL | TWO ROUNDS WEAPONS FREE WEAPONS FREE | |
| EXECUTION | ENGAGE UPON POSITIVE IDENTIFICATION | Sniper is free to engage. |
| TERMINATION | CEASE FIRE CEASE FIRE | |
| WEAPONS SAFETY STATUS RED | | |
| UPON COMPLETION OF THE ENGAGEMENT, THE TOWER DIRECTS THE SNIPER TEAM TO: FIRING POSITION E – 6:12 PITCH ROOF AND REPORT SET. | | |
| SNIPER TEAMS HAVE FOUR MINUTES FROM ACKNOWLEDGING TO REPORT SET IN FIRING POSITION E. | | |
| Legend: TMT-I – trackless moving targets–Infantry, TMT-V – trackless moving targets–vehicle, TRP - target reference point | | |

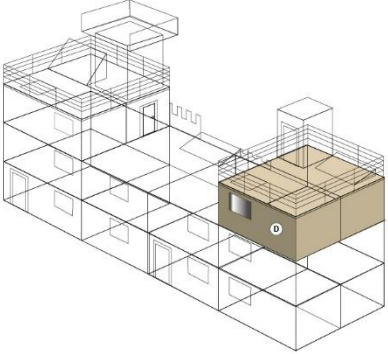
Table G-115. Sniper weapons, Table VI, Qualification, Stage 2, Night Fire, Assisted, Engagement 7, conduct of fire example

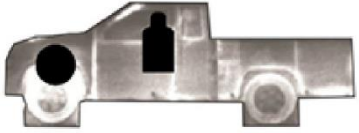

| <i>Table VI, Engagement 7 – 6:12 Pitch Roof, Unknown Distance</i> | | |
|--|--|--|
| Firing Position | M110 / M2010 Target | M107 Target |
|  |  TMT-I, MOVING 600 to 800 meters |  TMT-V, MOVING, DRIVER 1200 to 1300 meters |
| Element | Tower Prompt | Remarks |
| WEAPON SAFETY STATUS RED | | |
| ALERT | SIERRA TANGO (ONE) | |
| TARGET DESCRIPTION | MOVING TROOP (DRIVER) | |
| DIRECTION | TRP ____ | |
| CONTROL | TWO ROUNDS WEAPONS FREE WEAPONS FREE | |
| EXECUTION | ENGAGE UPON POSITIVE IDENTIFICATION | Sniper is free to engage. |
| TERMINATION | CEASE FIRE CEASE FIRE | |
| WEAPONS SAFETY STATUS RED | | |
| UPON COMPLETION OF THE ENGAGEMENT, THE TOWER DIRECTS THE SNIPER TEAM TO: FIRING POSITION F – BRIGHT ROOM AND REPORT SET. | | |
| SNIPER TEAMS HAVE FOUR MINUTES FROM ACKNOWLEDGING TO REPORT SET IN FIRING POSITION F. | | |
| Legend: TMT-I – trackless moving targets–Infantry, TMT-V – trackless moving targets–vehicle, TRP - target reference point | | |

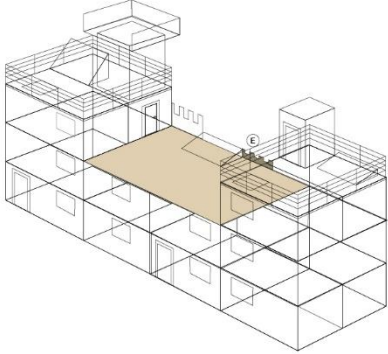
Table G-116. Sniper weapons, Table VI, Qualification, Stage 2, Night Fire, Assisted, Engagement 8, conduct of fire example

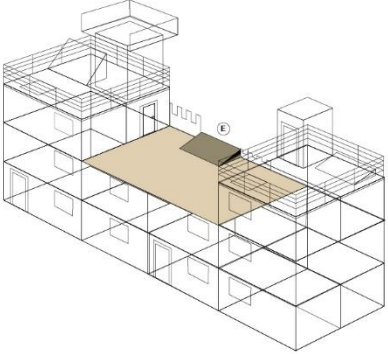

| <i>Table VI, Engagement 8 – Bright Room, Unknown Distance</i> | | |
|--|--|--|
| Firing Position | M110 / M2010 Target | M107 Target |
|  |  TMT-I, MOVING 300 to 500 meters |  TMT-V, MOVING, ENGINE 1400 to 1600 meters |
| Element | Tower Prompt | Remarks |
| WEAPON SAFETY STATUS RED | | |
| ALERT | SIERRA TANGO (ONE) | |
| TARGET DESCRIPTION | FLEEING HIGH VALUE TARGET | |
| DIRECTION | TRP _____ | |
| CONTROL | TWO ROUNDS (IMMOBILIZE VEHICLE) | |
| | WEAPONS FREE WEAPONS FREE | |
| EXECUTION | ENGAGE UPON POSITIVE IDENTIFICATION | Sniper is free to engage. |
| TERMINATION | CEASE FIRE CEASE FIRE | |
| WEAPONS SAFETY STATUS RED | | |
| UPON COMPLETION OF THE ENGAGEMENT, THE TOWER DIRECTS THE SNIPER TEAM TO: FIRING POSITION G – 12:12 PITCH ROOF AND REPORT SET. | | |
| SNIPER TEAMS HAVE FOUR MINUTES FROM ACKNOWLEDGING TO REPORT SET IN FIRING POSITION G. | | |
| Legend: TMT-I – trackless moving targets–Infantry, TMT-V – trackless moving targets–vehicle, TRP - target reference point | | |

Table G-117. Sniper weapons, Table VI, Qualification, Stage 2, Night Fire, Assisted, engagement 9, conduct of fire example

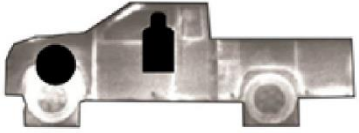

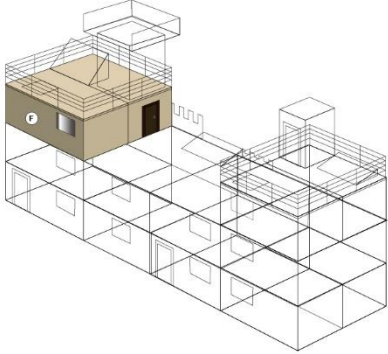

| <i>Table VI, Engagement 9 – 12:12 Pitch Roof, Unknown Distance</i> | | |
|--|--|---|
| Firing Position | M110 / M2010 Target | M107 Target |
|  |  TMT-I, EVASIVE 400 to 600 meters (M110) 800 to 1000 meters (M2010) |  TMT-V, EVASIVE, ENGINE 1200 to 1400 meters |
| Element | Tower Prompt | Remarks |
| WEAPON SAFETY STATUS RED | | |
| ALERT | SIERRA TANGO (ONE) | |
| TARGET DESCRIPTION | INSURGENTS MOVING INTO SECTOR | |
| DIRECTION | TRP _____ | |
| CONTROL | TWO ROUNDS (IMMOBILIZE ENGINE) WEAPONS FREE WEAPONS FREE | |
| EXECUTION | ENGAGE UPON POSITIVE IDENTIFICATION | Sniper is free to engage. |
| TERMINATION | CEASE FIRE CEASE FIRE | |
| WEAPONS SAFETY STATUS RED | | |
| UPON COMPLETION OF THE ENGAGEMENT, THE TOWER DIRECTS THE SNIPER TEAM TO: FIRING POSITION G – PARAPET AND REPORT SET. | | |
| SNIPER TEAMS HAVE FOUR MINUTES FROM ACKNOWLEDGING TO REPORT SET IN FIRING POSITION G. | | |
| Legend: TMT-I – trackless moving targets–Infantry, TMT-V – trackless moving targets–vehicle, TRP - target reference point | | |

Table G-118. Sniper weapons, Table VI, Qualification, Stage 2, Night Fire, Assisted, engagement 10, conduct of fire example

| <i>Table VI, Engagement 10 – Parapet, 30-inch, Unknown Distance</i> | | |
|---|---|---|
| Firing Position | M110 / M2010 Target | M107 Target |
|  |  <p>TMT-I, EVASIVE</p> <p>600 to 800 meters (M110) 800 to 1000 meters (M2010)</p> |  <p>TMT-V, EVASIVE, DRIVER</p> <p>1400 to 1600 meters</p> |
| Element | Tower Prompt | Remarks |
| WEAPON SAFETY STATUS | | |
| ALERT | SIERRA TANGO (ONE) | |
| TARGET DESCRIPTION | FLEEING INSURGENT (DRIVER) | |
| DIRECTION | TRP _____ | |
| CONTROL | TWO ROUNDS WEAPONS FREE WEAPONS FREE | |
| EXECUTION | ENGAGE UPON POSITIVE IDENTIFICATION | Sniper is free to engage. |
| TERMINATION | CEASE FIRE CEASE FIRE | |
| WEAPONS SAFETY STATUS RED | | |
| AT THE COMPLETION OF THIS ENGAGEMENT, TOWER REQUESTS A SITUATION REPORT WITH ROUNDS EXPENDED. | | |
| ONCE SNIPER TEAM REPORTS, TOWER CONTINUES. | | |
| <p>Legend: TMT-I – trackless moving targets–Infantry, TMT-V – trackless moving targets–vehicle, TRP - target reference point</p> | | |

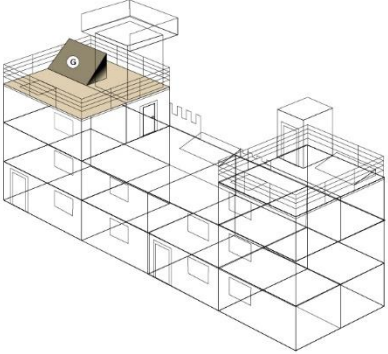
G-141. A lane safety clears the firers upon their completion of Table VI and collecting their dunnage. A lane safety verifies the clearing prior to the Soldier moving from the firing point. Once the lane safety clears all the Soldiers. The lane safety communicates the WSS to the tower operator. The tower operator issues an administrative command to move the completed Soldiers off the range. Table G-119 is an example of this command.

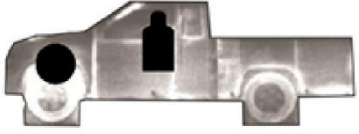
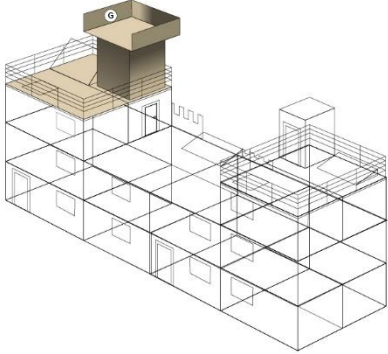
Table G-119. Completed firing order, conduct of the range example

| <i>Firing Order Complete</i> | | | |
|--|--|--|-----------------------|
| FIRING ORDER COMPLETE | Task | Target | Target Type |
| | Completed Firing Order | N/A | N/A |
| | Rounds per Target | DODIC | Time (Seconds) |
| | N/A | N/A | NO LIMIT |
| TOWER | | SOLDIER ACTION | |
| WEAPON SAFETY STATUS RED | | | |
| WEAPONS SAFETY STATUS GREEN | GO GREEN GO GREEN ONCE VERIFIED BY THE RSO, SECURE WEAPON | Soldiers clear their weapon and wait to be inspected by a lane safety. | |
| CONDUCT OF THE RANGE | SNIPERS SECURE YOUR DUNNAGE MOVE TO THE BASELINE. | Firers secure weapon and ammunition dunnage and move to the designated location. | |
| ONCE ALL SNIPERS RETURN TO THE BASELINE, TOWER DIRECTS THE FIRING ORDER OFF THE RANGE. | | | |
| Legend: DODIC – Department of Defense identification code, N/A – not applicable, RSO – range safety officer | | | |

G-142. As soon as the lane safety clears the completed firing order, the tower operator moves a new firing order into position and the process repeats itself until all firers have completed Table VI, Qualification, successfully. Any identified firers that require retraining move to the appropriate training location.

This page intentionally left blank.

Appendix H

Urban Rifle Marksmanship

This appendix describes the URM strategy for training through certification for all Infantry Soldiers assigned to MTOE Infantry squads. Completion of this certification is a prerequisite requirement prior to any Soldier executing live-fire training in a shoot house or other urban collective live-fire training event. This appendix culminates with defining the individual URM certification standards and requirements for those firers assigned an M4, M16, or M249 automatic rifle. Once successfully completed, Soldiers are certified to progress to higher levels of marksmanship training or certification, and to use the weapon during any future collective urban live-fire training events within the certification period.

This appendix provides an overview of the URM certification standards. This appendix is divided into sections, one for each training event within the weapon’s strategy. Commanders can use this appendix as a snapshot of the Army’s requirement to achieve and sustain a level of weapons proficiency for their Soldiers who participate in urban collective training live-fire events. Soldiers executing the URM training strategy must be qualified on their primary, assigned individual weapon. Soldiers may only use the optics and aiming devices that they have zeroed and are qualified with during the execution of this training strategy. This includes the assisted night fire certification within the past qualification and certification period based on the commander’s MAL.

URBAN RIFLE MARKSMANSHIP TRAINING STRATEGY

H-1. The standard IWTS format of six tables describes the training events. Each table explains the events with all associated resources required; ranges, simulators, simulations, ammunition, and time, as appropriate. Companies executing the training events apply the eight-step training model, as appropriate.

H-2. Table H-1 below shows the training strategy through qualification. The table explains the sequence of training events, the days required, and the training time remaining to achieve live-fire proficiency.

Table H-1. Individual weapons training strategy structure

| <i>Urban Rifle Marksmanship</i> | <i>Table I, PMI&E</i> | <i>Table II, PLFS</i> | <i>Table III, Drills</i> | <i>Table IV, Basic</i> | <i>Table V, Practice</i> | <i>Table VI, CERT</i> |
|--|-------------------------------|---------------------------|------------------------------|----------------------------|------------------------------|---------------------------|
| | <i>PRQ</i> | <i>PRQ</i> | <i>PRQ</i> | <i>REQUIRED</i> | | <i>REQUIRED</i> |
| Days Required | 0.5 | 0.5 | 1 | 0.5 | 1 | 1 |
| <p>Legend: CERT – certification, PLFS – preliminary live-fire simulation, PMI&E – preliminary marksmanship instruction and evaluation, PRQ – prerequisite</p> | | | | | | |

H-3. The ammunition required for the urban rifle marksman training strategy through certification is shown in table H-3. This list includes the associated weapons by LIN and NSN, all training munitions including DDI requirements, and the live-fire training ammunition requirements. The amount of rounds replicate what each firer is authorized to complete one full iteration of each event within the training strategy through certification. The munitions listed in table H-3 do not include retraining, cross-training, and demonstration munitions or collective training requirements.

H-4. Table H-2 provides the list of weapons by model, LIN, and NSN that, when assigned and directed, follow this training strategy for training through certification.

H-5. Table H-3 represents one complete training frequency through certification. Units must refer to DA PAM 350-38 for their authorized number of frequencies, based on their component (active Army or Reserves, respectively). The table does not list any retraining, cross-training or demonstration munitions.

Table H-2. Weapons following the urban rifle marksmanship training strategy

| Urban Rifle Marksmanship | | |
|--|--------|------------------|
| Nomenclature | LIN | NSN |
| M4 | R97234 | 1005-01-231-0973 |
| M4A1 | C06935 | 1005-01-382-0953 |
| M16A2 | R95035 | 1005-01-128-9936 |
| M16A4 | R97175 | 1005-01-383-2872 |
| M249 | M09009 | 1005-01-127-7510 |
| Legend: LIN – line item number, NSN – national stock number | | |

Table H-3. Urban rifle marksmanship training strategy ammunition requirements

| <i>DODIC</i> | <i>Munition Type</i> | <i>Table III, Drills</i> | <i>Table IV, Basic</i> | <i>Table V, Practice</i> | <i>Table VI, CERT</i> | <i>Total</i> |
|--|---|------------------------------|----------------------------|------------------------------|---------------------------|--------------|
| M4- and M16-series | | | | | | |
| A080 | CTG, 5.56mm, blank, M200 | 32 | | | | 32 |
| AB09 | CTG, 5.56mm, practice: marking, rifle, M1042 | | 32 | | | 32 |
| AB57 | CTG, 5.56mm: ball, M855A1 | | | 40 | 40 | 80 |
| M249AR | | | | | | |
| A075 | CTG, 5.56mm blank linked for squad automatic weapon | 50 | | | | 50 |
| AB16 | CTG, 5.56mm, practice: marking, linked, M1071 | | 50 | | | 50 |
| AB56 | CTG, 5.56mm linked M855A1, ball | | | 100 | 100 | 200 |
| <i>Model</i> | <i>LIN / NSN</i> | | <i>Model</i> | <i>LIN / NSN</i> | | |
| M4 | R97234 / 1005-01-231-0973 | | M16A2 | R95035 / 1005-01-128-9936 | | |
| M4A1 | C06935 / 1005-01-382-0953 | | M16A4 | R97175 / 1005-01-383-2872 | | |
| M249AR | M09009 / 1005-01-127-7510 | | | | | |
| Legend: AR – automatic rifle, CERT – certification course of fire, CTG – cartridge, DODIC – Department of Defense identification code, LIN – line item number, mm – millimeter, NSN – national stock number | | | | | | |

URBAN RIFLE MARKSMANSHIP, TABLE I, PRELIMINARY MARKSMANSHIP INSTRUCTION AND EVALUATION

H-6. The PMI&E event is a live fire prerequisite that Soldiers must complete prior to executing any live-fire event for the URM. URM, Table I, PMI&E lists tasks that are critical to the safety of the firer, essential to the operation of the weapon assigned, or key to effectively employing the weapon system. Leaders use the PMI&E event to test the Soldier's ability to accomplish these critical tasks correctly, effectively, and efficiently. Units conduct all tasks in a garrison environment prior to the live-fire weapons training density.

TASK, CONDITIONS, AND STANDARD

H-7. Units are encouraged to conduct preparatory training prior to Table I training (for example, hip pocket training, STT) to maximize available resources. Units will develop a written test evaluating the functional aspects of the weapon, ammunition, and critical skills articulated in the appropriate TC. Soldiers must successfully complete URM, Table I, PMI&E tasks, within the training window T-6 through T-week for both Active Army and Reserves. (See table H-4 on page H-4.)

Note. Refer to TC 3-20.0 for more information on the training timelines for all live fire prerequisites. See TC 3-22.9 for weapon specific and tactical employment information regarding URM.

H-8. At a minimum, Soldiers assigned an M4, M16, or M249 automatic rifle weapon that will follow the URM training strategy are provided instruction and evaluation on the standard PMI&E topics described in TC 3-22.9 and TC 3-22.249. Units may add topics to their Table I requirements, as needed.

Table H-4. Urban rifle marksmanship, Table I, Preliminary Marksmanship Instruction and Evaluation, task, conditions, and standard

| | |
|--|---|
| Task: | Demonstrate proficiency on the functional aspects of the weapon, ammunition, and critical skills necessary to correctly and safely employ the weapon in an urban environment. |
| Conditions: | <p>In a garrison environment, given a M4, M16, M249 automatic rifle as assigned on the master authorization list for the unit. Provided the correct reference to conduct training:</p> <ul style="list-style-type: none"> • Training Circular (TC) 3-22.9. • TC 3-22.249. • Technical Manual (TM) 9-1005-319-10. • TM 9-1005-201-10. |
| Standard: | The Soldier must successfully pass the PMI&E between T-6 and T-week prior to firing any live ammunition by receiving all GOs on demonstrated performance and achieving a passing score of 80 percent or higher on a written test. |
| Legend: PMI&E – preliminary marksmanship instruction and evaluation, URM – urban rifle marksmanship | |

H-9. Table H-5 shows the training event design template for URM, Table I, PMI&E. Units use the training event design templates to assist in the proper synchronization when developing their UTP.

Table H-5. Training event design template for urban rifle marksmanship, Table I

| <i>URM, Table I, PMI&E</i> | | | | | | |
|---|----------------------------|---------------------|----------------------|---------------------------------|-----------------------|---------------------------|
| EVENT NAME: | PMI&E | ENVIRONMENT: | LIVE | 0.5 | | |
| WEAPON: | M4, M16, M249AR | CONDITIONS: | HANDS ON | | | |
| CATEGORY: | FOUNDATION | PRIMARY FACILITY: | GARRISON | DAYS REQUIRED | | |
| PUBLICATION: | TC 3-22.9 / TC 3-22.249 | ALTERNATE FACILITY: | CLASS | | | |
| REQUIRED: | YES | COMPONENT: | AC | RC | 150 SOLDIERS | |
| EXTERNAL EVAL: | OPTIONAL | FREQUENCY: | 2 | 1 | | |
| VALID FOR: | T+6 | ANNUAL DAYS TOTAL: | 1 | 0.5 | THROUGHPUT | |
| TABLE | | | | | | |
| | I | II | III | IV | V | VI |
| | PMI&E | PLFS | DRILLS | BASIC | PRACTICE | CERT |
| | REQUIRED | | | | | 4.5 |
| WHEN EXECUTED: | T-6 through T-X | | | | | TNG DAYS TO QUAL |
| CONDEMNATION CRITERIA (CC) | RULE 1 | RULE 2 | RULE 3 | RULE 4 | RULE 5 | RULE 6 |
| | TIME | KEY LEADER TURNOVER | COMMANDER ASSESSMENT | SUBORDINATE ELEMENT PROFICIENCY | SPECIALTY PROFICIENCY | STAFF SECTION PROFICIENCY |
| Remarks: Each Soldier assigned to an MTOE Infantry squad that will participate in a shoot house or other urban collective live-fire event must successfully complete Table I, PMI&E, between T-6 and T-X, <i>prior to any urban live-fire event with the weapon.</i> | | | | | | |
| Note: Table I <i>should</i> be completed prior to any other table to ensure the Soldier understands the proper functioning and immediate action for the weapon. | | | | | | |
| Legend: AC – active component (known as active duty), AR – automatic rifle, CERT – certification, CLASS - classroom, EVAL – evaluation, MTOE – modification table of organization and equipment, PLFS – preliminary live-fire simulation, PMI&E – preliminary marksmanship instruction and evaluation, RC – Reserve Component (known as Reserves), STT – sergeant’s time training, TC – training circular, T+6 – training week or month plus six, TNG DAYS TO QUAL – number of training days remaining on the critical path to weapon’s qualification, T-X – training event exercise, URM – urban rifle marksmanship | | | | | | |

TRAINING PLAN

H-10. Table H-6 shows the URM Table I, PMI&E training plan's tasks. The Soldier demonstrates proficiency on these tasks to receive credit. Leaders and trainers must be proficient on these tasks prior to conducting training and testing. The intent of the training and evaluation of these topics is to focus on urban marksmanship and not simply repeated from rifle qualification.

Table H-6. Urban rifle marksmanship Table I, Preliminary Marksmanship Instruction and Evaluation training plan

| Reference | Topic or Task |
|---|---|
| TC 3-22.9 | Urban rifle marksmanship firing stance |
| TC 3-22.9 | Weapon ready positions |
| TC 3-22.9 | Urban rifle marksmanship movement techniques |
| TC 3-22.9 | Urban rifle marksmanship aiming/ engagement techniques |
| TC 3-22.9 | Urban rifle marksmanship point of aim |
| TC 3-22.9 | Urban rifle marksmanship trigger manipulation |
| TC 3-22.9 / TC 3-22.249 | Rules of fire arms safety |
| TC 3-22.9 / TC 3-22.249 | Weapons safety status |
| TC 3-22.9 / TC 3-22.249 | Weapons control status |
| TC 3-20.31-4 | Conduct of fire (fire commands) |
| 071-COM-0033 | Correct malfunctions of an M16-series rifle / M4-series carbine |
| 071-COM-4029 | Correct malfunctions of an M249 machine gun |
| <p>Note: ALL Soldiers assigned to an MTOE Infantry squad who will participate in a shoot house or other urban collective live-fire event will conduct PMI&E. Soldiers will conduct Maintain and Functions Check tasks only for the weapon they are assigned.</p> | |
| <p>Legend: COM – common, PMI&E – preliminary marksmanship instruction and evaluation, MTOE – modification table of organization and equipment, TC – training circular</p> | |

URBAN RIFLE MARKSMANSHIP, TABLE II, PRELIMINARY LIVE-FIRE SIMULATIONS

H-11. The tasks in Table II, PLFS evaluate the Soldier's ability to engage single and multiple stationary targets at close range from stationary and moving unsupported firing positions, during day and limited visibility, and during CBRN conditions in a simulated combat environment. Soldiers must complete the simulations training plan prior to executing the Table II simulated qualification course of fire. The Table II task (see table H-7) is a live-fire prerequisite that Soldiers complete prior to any event using live ammunition (Tables IV, V, and VI, for example).

TASK, CONDITIONS, AND STANDARD

H-12. Units must use the approved primary or alternate simulations to execute Table II elements for record between T-6 and T-week for the upcoming weapons training density. Units must maintain the Soldier's training records for a period of 12 months. When conducting live-fire events, units must have the Soldier's Table II training records readily available on the range facility.

Table H-7. Urban rifle marksmanship, Table II, Preliminary-Live-Fire Simulations, task, conditions, and standard

| | |
|--------------------|--|
| Task: | Demonstrate proficiency on the functional aspects of the weapon, ammunition, and critical skills necessary to correctly use the M4, M16, or M249 automatic rifle with associated equipment in an urban environment. |
| Conditions: | <p>Given the following:</p> <ul style="list-style-type: none"> • Fully mission capable weapon and equipment as assigned on the master authorization list for the unit. • Full combat uniform, issued equipment, and protective mask (if assigned). • An authorized simulations device with standard training model and urban rifle marksmanship (URM), Table II Gate to Live Fire (GTLF) event. |
| Standard: | Demonstrate proficiency on URM tasks and successfully complete the GTLF event between T-6 and T-week prior to firing any live ammunition. |

H-13. Table H-8, on page H-8, shows the general training information for planning purposes for the URM, Table II. The training event design template provides key training information to develop the UTP for their Soldiers.

Table H-8. Training event design template for urban rifle marksmanship, Table II, Preliminary-Live-Fire Simulations

| <i>URM, Table II, PLFS</i> | | | | | | |
|---|----------------------------|---------------------------|-------------------------|---------------------------------------|--------------------------|---------------------------------|
| EVENT NAME: | PLFS | | ENVIRONMENT: | | VIRTUAL | 1.0 |
| WEAPON: | M4, M16, M249AR | | CONDITIONS: | | TADSS | |
| CATEGORY: | FOUNDATION | | PRIMARY FACILITY: | | S/SVT | DAYS REQUIRED |
| PUBLICATION: | TC 3-22.9 / TC 3-22.249 | | ALTERNATE FACILITY: | | EST | |
| REQUIRED: | YES | | COMPONENT: | AC | RC | 150 SOLDIERS |
| EXTERNAL EVAL: | OPTIONAL | | FREQUENCY: | 2 | 1 | |
| VALID FOR: | T+6 | | ANNUAL DAYS TOTAL: | 2 | 1 | THROUGHPUT |
| | TABLE | | | | | |
| | I | II | III | IV | V | VI |
| | PMI&E | PLFS | DRILLS | BASIC | PRACTICE | CERT |
| | | REQUIRED | | | | 3.5 |
| WHEN EXECUTED: | T-6 through T-X | | | | | TNG DAYS TO QUAL |
| CONDEMNATION CRITERIA (CC) | RULE 1 | RULE 2 | RULE 3 | RULE 4 | RULE 5 | RULE 6 |
| | TIME | KEY LEADER TURNOVER | COMMANDER ASSESSMENT | SUBORDINATE ELEMENT PROFICIENCY | SPECIALTY PROFICIENCY | STAFF SECTION PROFICIENCY |
| Remarks: Each Soldier assigned to an MTOE infantry squad that will participate in a shoot house or other urban collective live-fire event must successfully complete Table II, PLFS, between T-6 and T-X, prior to any urban live-fire event with the weapon. | | | | | | |
| Legend: AC – active component (known as active duty), AR – automatic rifle, CERT – certification, EST – engagement skills trainer, EVAL – evaluation, MTOE – modification table of organization and equipment, PLFS – preliminary live-fire simulation, PMI&E – preliminary marksmanship instruction and evaluation, RC – Reserve Component (known as Reserves), S/SVT – soldier and squad virtual trainer, TADSS – training aids, devices, simulators, and simulations, TC – training circular, T+6 – training week or month plus six, T-X – training event exercise, TNG DAYS TO QUAL – number of training days remaining on the critical path to weapon’s qualification, URM – urban rifle marksmanship | | | | | | |

SIMULATIONS

H-14. Each Soldier is authorized simulations usage for weapons training and sustainment based on their component. The authorized hours of training are cumulative annually to enable completing all required training prior to the execution of Table II training. Table H-9 shows the annual hours authorized per Soldier by component.

Table H-9. Simulations authorizations table

| <i>Simulation Time Authorizations (hours)</i> | |
|---|-----------------|
| <i>Active Army</i> | <i>Reserves</i> |
| 12.0 | 6.0 |

H-15. Table H-10 lists the primary and alternate simulations systems. Primary systems are the preferred method to deliver the appropriate training program to Soldiers. Alternate systems provide the minimum form, fit, and function capabilities to build the firers' skills and experiences on basic tasks. The unit determines how the simulations hours authorized per Soldier are used in the fiscal year.

Table H-10. Urban rifle marksmanship, Table II, primary and alternate authorized systems

| System | Primary | Alternate | Remarks |
|---|----------------|------------------|---|
| Soldier and squad virtual trainer (S / SVT) | X | | |
| Engagement skills trainer (EST) | | X | Serves as a primary training device until S / SVT suite availability and accessibility are established Army-wide. |
| Dry-fire engagement drills | | X | Least preferred method. Commanders should review dry-fire drill tasks and effectiveness prior to authorizing use. |

Note. For any other device or system not listed, the unit should contact the Maneuver Center of Excellence for possible system evaluation or to inquire if an approved training plan is available. Units are not authorized to develop training plans on systems not specifically authorized when authorized systems are available for training.

Individual weapons virtual simulation systems can effectively support no more than five firers per suite at a time. The standard simulations bay is composed of two suites, allowing 10 firers to train in a firing order. The unit will need to develop a rotational plan to accommodate the total number of Soldiers training.

TRAINING PLAN

H-16. Soldiers train on their weapon within the simulation system's training plan. For simulation systems without an integrated training plan, operators must select the appropriate scenarios based on the system's IUH.

H-17. The simulations URM training plan culminates in the system's GTLF. Units may elect to train additional advanced tactical engagement scenarios, but must conduct reflexive fire, practice, CBRN, night fire, and the GTLF exercises at a minimum, as listed in table H-11 on page H-10.

Table H-11. Urban rifle marksmanship simulations training plan

| Task | Simulations Exercise Name | Required GTLF |
|---|---|----------------------|
| 1 | Auto zero (system maintenance function) | REQ |
| 2 | Reflexive fire | REQ |
| 3 | Table V, Practice | REQ |
| 4 | CBRN Fire | REQ |
| 5 | Night Fire | REQ |
| 6 | Table VI, Certification | GTLF |
| 7 | Target discrimination | OPT |
| 8 | Magazine change multiple-target | OPT |
| 9 | Multiple directional moving target | OPT |
| 10 | Transition from primary to secondary weapon | OPT |
| Legend: CBRN – chemical, biological, radiological, and nuclear, GTLF – gate to live fire, OPT – optional, REQ – required | | |

URBAN RIFLE MARKSMANSHIP, TABLE III, DRILLS

H-18. Table III, Drills lists a series of physical actions (drills) that a Soldier completes with their assigned weapon and equipment in a repetitious manner to demonstrate proficiency in weapons handling and movement. This table must be successfully completed. Soldiers must complete the task in this table prior to any live-fire event, including grouping procedures.

TASK, CONDITIONS, AND STANDARD

H-19. Typically, units conduct Table III in a round-robin manner where the primary trainer is the team leader, squad leader, or assigned NCO. Table III's task, conditions, and standard are shown below in table H-12.

Table H-12. Urban rifle marksmanship, Table III, Drills, task, conditions, and standard

| | |
|--------------------|--|
| Task: | Demonstrate proficiency on the functional aspects of the weapon, ammunition, and critical skills necessary to correctly use the M4, M16, or M249 automatic rifle weapon with associated assigned equipment. |
| Conditions: | Given the following: <ul style="list-style-type: none"> Fully mission capable, weapon and equipment as assigned on the master authorization list for the unit. Checklist of required actions and time standards found in Training Circular (TC) 3-22.9, TC 3-22.249 and associated individual task report described in this section. |
| Standard: | The Soldier successfully demonstrates proficiency by passing weapons handling, manipulation, and movement between T-6 and T-week prior to firing any live ammunition. |

H-20. Table H-13 shows the general training information for planning purposes for URM, Table III. The training event design template provides key training information to develop the UTP for their Soldiers.

Table H-13. Training event design template for urban rifle marksmanship, Table III, Drills

| URM, Table III, Drills | | | | | | | |
|---|----------------------------|---------------------------|-------------------------|---------------------------------------|--------------------------|---------------------------------|-------------|
| EVENT NAME: | DRILLS | ENVIRONMENT: | | LIVE | 1.0 | | |
| WEAPON: | M4, M16, M249AR | CONDITIONS: | | HANDS ON | | | |
| CATEGORY: | FOUNDATION | PRIMARY FACILITY: | | GARRISON | DAYS REQUIRED | | |
| PUBLICATION: | TC 3-22.9 / TC 3-22.249 | ALTERNATE FACILITY: | | TA | | | |
| REQUIRED: | YES | COMPONENT: | AC | RC | 150 SOLDIERS | | |
| EXTERNAL EVAL: | FIRST LINE LEADER | FREQUENCY: | 2 | 1 | | | |
| VALID FOR: | T+6 | ANNUAL DAYS TOTAL: | 2 | 1 | THROUGHPUT | | |
| TABLE | | | | | | | |
| | | I | II | III | IV | V | VI |
| | | PMI&E | PLFS | DRILLS | BASIC | PRACTICE | CERT |
| | | | | REQUIRED | | | 2.5 |
| WHEN EXECUTED: | T-6 through T-X or T-X | | | | | TNG DAYS TO QUAL | |
| CONDEMNATION CRITERIA (CC) | RULE 1 | RULE 2 | RULE 3 | RULE 4 | RULE 5 | RULE 6 | |
| | TIME | KEY LEADER TURNOVER | COMMANDER ASSESSMENT | SUBORDINATE ELEMENT PROFICIENCY | SPECIALTY PROFICIENCY | STAFF SECTION PROFICIENCY | |
| <p>Remarks: Each Soldier assigned to an MTOE Infantry squad that will participate in a shoot house or other urban collective live-fire event must successfully complete Table III, between T-6 and T-X, <i>prior to any urban live-fire event with the weapon</i>. Table III should be used as concurrent training on Tables IV, V, and VI while Soldiers are awaiting training in a firing order or between day and night phases.</p> <p>Legend: AC – active component (known as active duty), AR – automatic rifle, CERT – certification, EVAL – evaluation, MTOE – modification table of organization and equipment, PLFS – preliminary live-fire simulation, PMI&E – preliminary marksmanship instruction and evaluation, RC – Reserve Component (known as Reserves), TA – training area, TC – training circular, TNG DAYS TO QUAL – number of training days remaining on the critical path to weapon’s qualification, T+6 – training week or month plus six, T-X – training event exercise, URM – urban rifle marksmanship</p> | | | | | | | |

TRAINING PLAN

H-21. Table H-14, on page H-12, lists individual tasks for each of these drills. The individual task reports for these drills are in a shared folder on AKO. The hyperlink to this folder is in the reference section at the back of this publication.

Table H-14. Urban rifle marksmanship, Table III, Drills individual training plan

| Task | Task Name |
|--|---|
| 1 | Precombat checks |
| 2 | Rifle / carbine magazine change, emergency |
| 3 | Rifle/ carbine magazine change, tactical |
| 4 | Automatic rifle reload with belt |
| 5 | Automatic rifle reload with magazine |
| 6* | Engagement techniques: straight ahead, turn left, turn right, turn rear, kneeling unsupported |
| 7* | Movement techniques: Walking, lateral left, lateral right, run and stop |
| 8 | Clear malfunction |
| <p>Note. Where the individual task reports are not available on the Army Training Network, the individual task reports for these drills are in a shared folder on Army Knowledge Online. The hyperlink to this folder is in the reference section at the back of this publication.</p> <p>*Task 6 and 7 may be conducted with blank ammunition. The conduct of these tasks is designed to complement Table IV, Basic and are executed in the same manner.</p> | |

H-22. Units may add to the drills listed in table H-14, but may not remove any from Table III. Units developing additional drills are encouraged to provide the details of the drill, evaluation process, and timing considerations to the proponent of this publication for possible inclusion into future updates.

URBAN RIFLE MARKSMANSHIP, TABLE IV, BASIC (REFLEXIVE FIRE)

H-23. Units conduct URM, Table IV, Basic (Reflexive Fire) with live ammunition on an approved range facility. Leaders use Table IV for all firers to evaluate their ability to consistently place shots within a designated lethal zone of the target at ranges between 5 to 25 meters. Units conduct the tasks in this table only after completing the live-fire prerequisite tables (Tables I, II, and III). During home station training, Soldiers must complete Table IV tasks prior to progressing to any other training event. Units conduct Table IV tasks on a basic 10 meter or 25 meter firing range (zero) or other approved facility.

H-24. The purpose of the URM, Table IV, Basic is to introduce Soldiers to the basic movements, aiming techniques, and trigger controls as they relate to URM. Unlike the conduct of fire used previously during rifle training and qualification, URM uses simplified commands delivered at a moderate or rapid tempo. The commands provided to the Soldier during URM describe the engagement or movement technique. Instructions to the firer are followed by two subsequent commands, READY and UP. READY is the preparatory command, and UP is the command of execution during this event.

H-25. All firer's participating in Table IV must have previously zeroed and qualified the weapon with associated aiming devices. If the firer has made any changes to the weapon or aiming device, the firer must confirm zero at 25 meters prior to executing Table IV.

TASK, CONDITIONS, AND STANDARD

H-26. Firers conduct Table IV tasks while stationary and while moving from the standing unsupported firing position at various close quarters ranges outlined in this appendix. The Table IV task reinforces and builds upon skills learned in the previous training events. Table H-15 provides the task, conditions, and standards for Table IV.

Table H-15. Urban rifle marksmanship, Table IV, Basic (reflexive fire)

| | |
|--------------------|--|
| Task: | Demonstrate lethal shot placement proficiency with the M4, M16, or M249 automatic rifle. |
| Conditions: | Given the following: <ul style="list-style-type: none"> Fully mission capable weapon, magazine pouches, and magazines. Authorized range facility, authorized practice ammunition, and approved targetry. |
| Standard: | Achieve a minimum hits of 24 of 32 (M4 / M16) or 37 of 50 (M249 automatic rifle) inside the appropriate area of the lethal zone on the B7 target (the lethal zone of the B7 target is the area on the target indicated with the number 5). |

H-27. Table H-16 shows the training event design template for the Table IV, Basic (Reflexive Fire). Units conduct this event on an authorized live-fire facility, typically a basic 10 meter / 25 meter firing range (zero). See TC 25-8 for additional information on authorized range facilities.

Table H-16. Training event design template for urban rifle marksmanship, Table IV, Basic (reflexive fire)

| <i>URM, Table IV, Basic</i> | | | | | | |
|--|----------------------------|---------------------------|-------------------------|---------------------------------------|--------------------------|---------------------------------|
| EVENT NAME: | BASIC | | ENVIRONMENT: | LIVE | 0.5 | |
| WEAPON: | M4, M16, M249 | | CONDITIONS: | LIVE FIRE | | |
| CATEGORY: | FOUNDATION | | PRIMARY FACILITY: | Zero | DAYS REQUIRED | |
| PUBLICATION: | TC 3-22.9 / TC 3 22.249 | | ALTERNATE FACILITY: | QTR | | |
| REQUIRED: | YES | COMPONENT: | AC | RC | 150 SOLDIERS | |
| EXTERNAL EVAL: | COACH | FREQUENCY: | 2 | 1 | | |
| VALID FOR: | T-X | ANNUAL DAYS TOTAL: | 1 | 0.5 | THROUGHPUT | |
| TABLE | | | | | | |
| | | I | II | III | IV | V |
| | | PMI&E | PLFS | DRILLS | BASIC | PRACTICE |
| | | PRQ | PRQ | PRQ | REQUIRED | 2.0 |
| WHEN EXECUTED: | | | | T-X | | TNG DAYS TO QUAL |
| CONDEMNATION CRITERIA (CC) | RULE 1 | RULE 2 | RULE 3 | RULE 4 | RULE 5 | RULE 6 |
| | TIME | KEY LEADER TURNOVER | COMMANDER ASSESSMENT | SUBORDINATE ELEMENT PROFICIENCY | SPECIALTY PROFICIENCY | STAFF SECTION PROFICIENCY |
| Remarks: Each Soldier assigned to an MTOE Infantry squad that will participate in a shoot house or other urban collective live-fire event must successfully complete Table IV, Basic. | | | | | | |
| Legend: AC – active component (known as active duty), CERT – certification, EVAL – evaluation, MTOE – modification table of organization and equipment, PLFS – preliminary live-fire simulation, PMI&E – preliminary marksmanship instruction and evaluation, PRQ – prerequisite, QTR – qualification training range, RC – Reserve Component (known as Reserves), TC – training circular, TNG DAYS TO QUAL – number of training days remaining on the critical path to weapon's qualification, T-X – training event exercise, URM – urban rifle marksmanship, Zero – basic 10 meter / 25 meter range (zero) | | | | | | |

AMMUNITION

H-28. All Infantry Soldiers assigned to a rifle squad that will participate in a shoot house or other urban collective training event will complete URM, Table IV prior to advancing to Table V or Table VI. Units conduct the tasks in this table to demonstrate the Soldier's ability to consistently place well-aimed shots at or near the intended point of impact (lethal zone) of a target. This skill is critical to the success of the Soldier during training and combat.

H-29. To effectively plan and forecast for sufficient training ammunition, the unit must refer to the ammunition requirements listed in table H-17. Units need to identify the total number of firers and should

plan for unscheduled firers and necessary retraining by increasing their forecasted training ammunition appropriately.

Table H-17. Table IV, Basic (reflexive fire) ammunition authorizations

| <i>Training Event</i> | <i>DODIC</i> | <i>Nomenclature</i> | <i>Quantity</i> | <i>Remarks</i> |
|--|--------------|---|-----------------|---|
| Basic | AB09 | CTG, 5.56mm, practice: marking, rifle, M1042, BLUE | 32 | These cartridges are used with the close combat mission capability kit (CCMCK) conversion bolt for force-on-force training in local and urban terrain environments. |
| | AB16 | CTG, 5.56mm, practice: marking, linked, M1071, BLUE | 50 | |
| Legend: CTG – cartridge, DODIC – Department of Defense identification code, mm – millimeter | | | | |

H-30. The ammunition NCO with a supporting detail (ammunition detail) loads four magazines with 8-rounds each per M4 or M16 firer. The detail must also prepare and issue belts of 50-rounds inside the belt container per M249 automatic rifle firer. This will require the ammunition detail to reuse M249 belt containers for subsequent firing orders.

H-31. Table IV is an un-timed event. Units issue M4 and M16 firers four, eight-round magazines (32 rounds total) or one belt container loaded with 50, linked rounds for the M249 automatic rifle firers. Table H-18 lists the ammunition breakdown for URM. Firers place ammunition in their ammunition pouches. Staging or pre-positioning ammunition is not authorized for the conduct of Table IV.

Table H-18. Urban rifle marksmanship, Table IV, ammunition breakdown per firer

| <i>Magazine / Belt</i> | <i>AB09 CCMCK SINGLE BLUE</i> | <i>AB16 CCMCK LINKED BLUE</i> | <i>Remarks</i> |
|------------------------|-------------------------------|-------------------------------|---|
| 1 | 8 | 50 | These cartridges are used with the close combat mission capability kit (CCMCK) conversion bolt for force-on-force training in local and urban terrain environments. |
| 2 | 8 | | |
| 3 | 8 | | |
| 4 | 8 | | |
| Total | 32 | 50 | |

RANGE FACILITIES

H-32. Table H-19 shows the Army-standard range facilities designed to support URM, Table IV, Basic (Reflexive Fire). Units reference their installation’s range operations SOPs or local training regulation to identify the weapon-specific range facilities on the supporting installation. Units use their RFMSS system for all scheduling.

Table H-19. Urban rifle marksmanship Table IV, Basic (reflexive fire) authorized range facilities and targetry

| Range to Target | Targetry | Range Facility | |
|---|--|----------------|-----|
| | | Zero | QTR |
| 5-25 m | B7, target silhouette: paste board, standing image, 25 per box NSN 6920-00-951-3956 | P | A |
| Legend: A – alternate facility, P – primary facility, m – meter, QTR – automated qualification training range, NSN – national stock number, Zero – basic 10 meter / 25 meter firing range (zero) | | | |

TARGETRY

H-33. Table IV requires the use of the targets as shown in figure H-1. The target is placed on a frame with backer board at the 25-meter line. During the preparation phase, leaders should be familiar with the targetry used, the target frames and their proper emplacement, and the firing sequence of the engagements. Figure H-1 shows the authorized target used during Table IV.

| URM, Table IV Targetry | |
|---|---|
|  |  |
| <p>B-7, target silhouette: paste board, standing image 25 per box</p> <p>NSN 6920-00-951-3956</p> | <p>Note: Units may use as many B-7 targets as needed to suit the instruction. This example provides one target for each firer.</p> |
| <p>Legend: NSN – national stock number, URM – urban rifle marksmanship</p> | |

Figure H-1. Urban Rifle Marksmanship, Table IV target requirements example

H-34. The paste board target is secured on a target frame’s backer board. Figure H-2 shows the target engagement sequence.

H-35. All firing positions are described as distances from the target. The range NCOIC and the target detail install the required targetry and identify and mark the engagement distances from the 5 to 25 meters in 5-meter increments as shown in figure H-2.

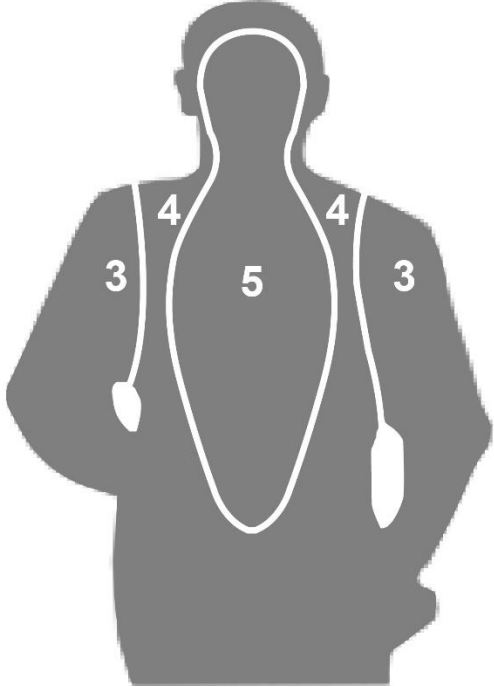
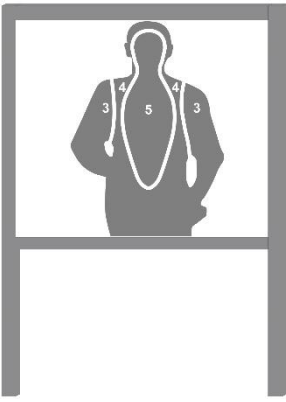
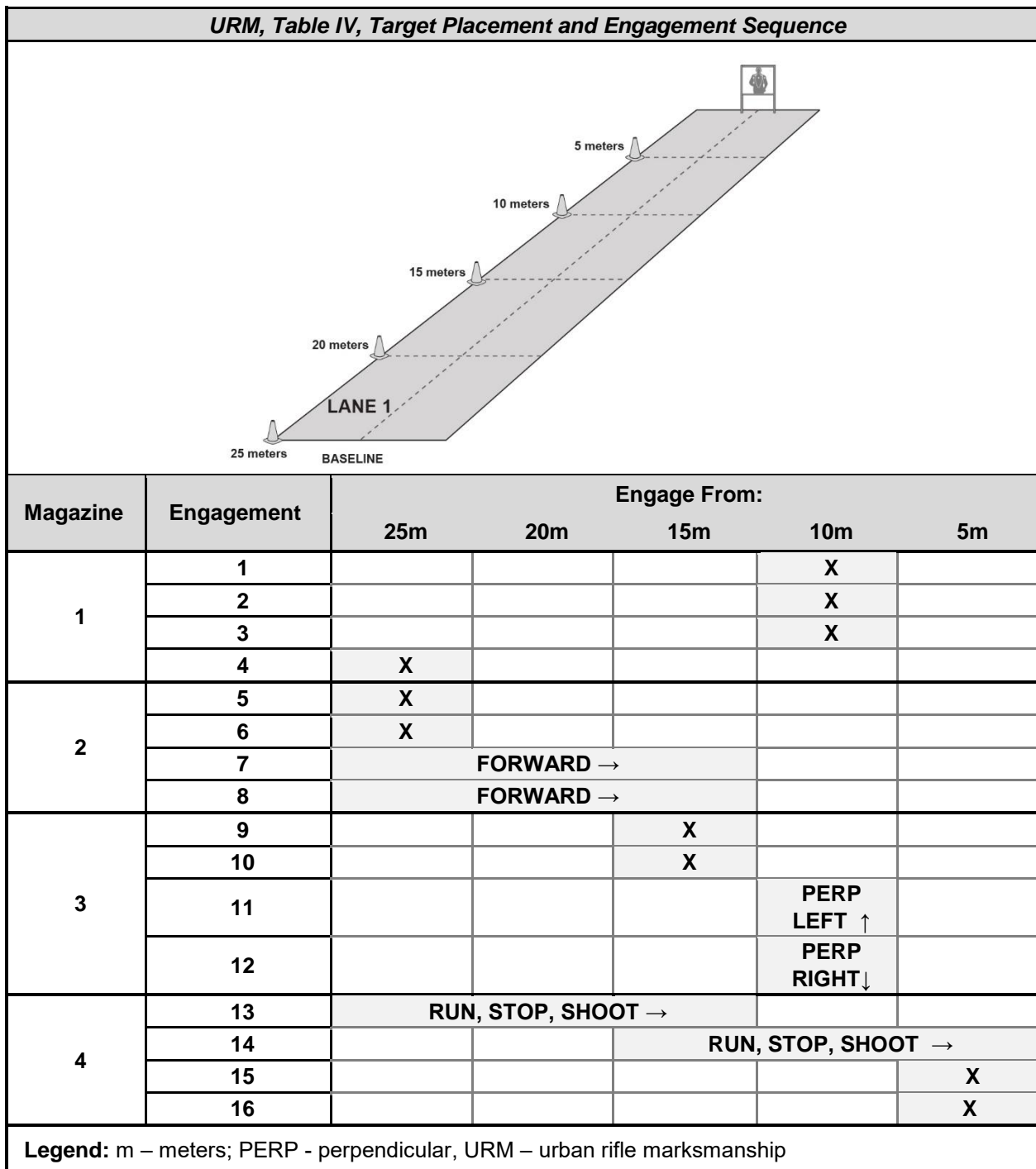

Figure H-2. Target emplacement with engagement distances example

CONDUCT OF THE RANGE

H-36. Leaders teach Soldiers on the objectives of reflexive fire and the importance of the functional elements of the shot process (see TC 3-22.9 and TC 3-22.249, respectively). Units conduct Table IV tasks using 16 engagements from various distances (range lines) with two round (M4 and M16) or three-round bursts (M249 automatic rifle) fired during each engagement. Soldiers complete the engagements in the sequence shown in table H-20.

Table H-20. Urban rifle marksmanship, Table IV, firing sequence example

| Magazine | Engagement | Range Line | M4 / M16 | M249AR | Engagement/ Movement |
|--|------------|------------|---|---|--|
| | | | AB09 5.56mm CCMCK SINGLE BLUE | AB16 5.56mm CCMCK LINKED BLUE | |
| 1 | 1 | 10 | 2 | 3 | Standing straight ahead |
| | 2 | 10 | 2 | 3 | Standing left turn |
| | 3 | 10 | 2 | 3 | Standing right turn |
| | 4 | 25 | 2 | 3 | Standing straight ahead |
| 2 | 5 | 25 | 2 | 3 | Standing left turn |
| | 6 | 25 | 2 | 3 | Standing right turn |
| | 7 | 25-15 | 2 | 4 | Walking straight ahead, chest and head, 2 shots each |
| | 8 | | 2 | 4* | |
| 3 | 9 | 15 | 2 | 3 | Standing turning to the rear, chest and head, 2 shots each |
| | 10 | 15 | 2 | 3* | |
| | 11 | 10 | 2 | 3 | Walking perpendicular left |
| | 12 | 10 | 2 | 3 | Walking perpendicular right |
| 4 | 13 | 25-15 | 2 | 3 | Run stop shoot |
| | 14 | 15-5 | 2 | 3 | Run stop shoot |
| | 15 | 5 | 2 | 3 | Standing straight ahead |
| | 16 | 5 | 2 | 3 | Standing straight ahead |
| <p>Note. * A headshot is defined as any shot striking within zone 5 that is completely above the shoulders of a silhouette.</p> <p>Legend: CCMCK - close combat mission capability kit, M249AR –automatic rifle, mm – millimeter</p> | | | | | |

H-38. Leaders use the following guidelines are followed to properly evaluate URM, Table IV. The firer must—

- Place 75-percent of shots fired in lethal zone 5 (primary, switch). Leaders use lethal zone engagements to train Soldiers to engage the most vulnerable area of an enemy that is equipped with or without body armor, with focus on the chest cavity, neck, spinal column, and brain.
- Have all rounds fired impact in the primary (circuitry) or secondary (timer) zones, on the B-7 target, zones 4 and 5, respectively.

H-39. Any shot impacting outside of the silhouette results in an automatic NO-GO for Table IV. Figure H-3 is a description of the required shot placements during the engagement sequence.

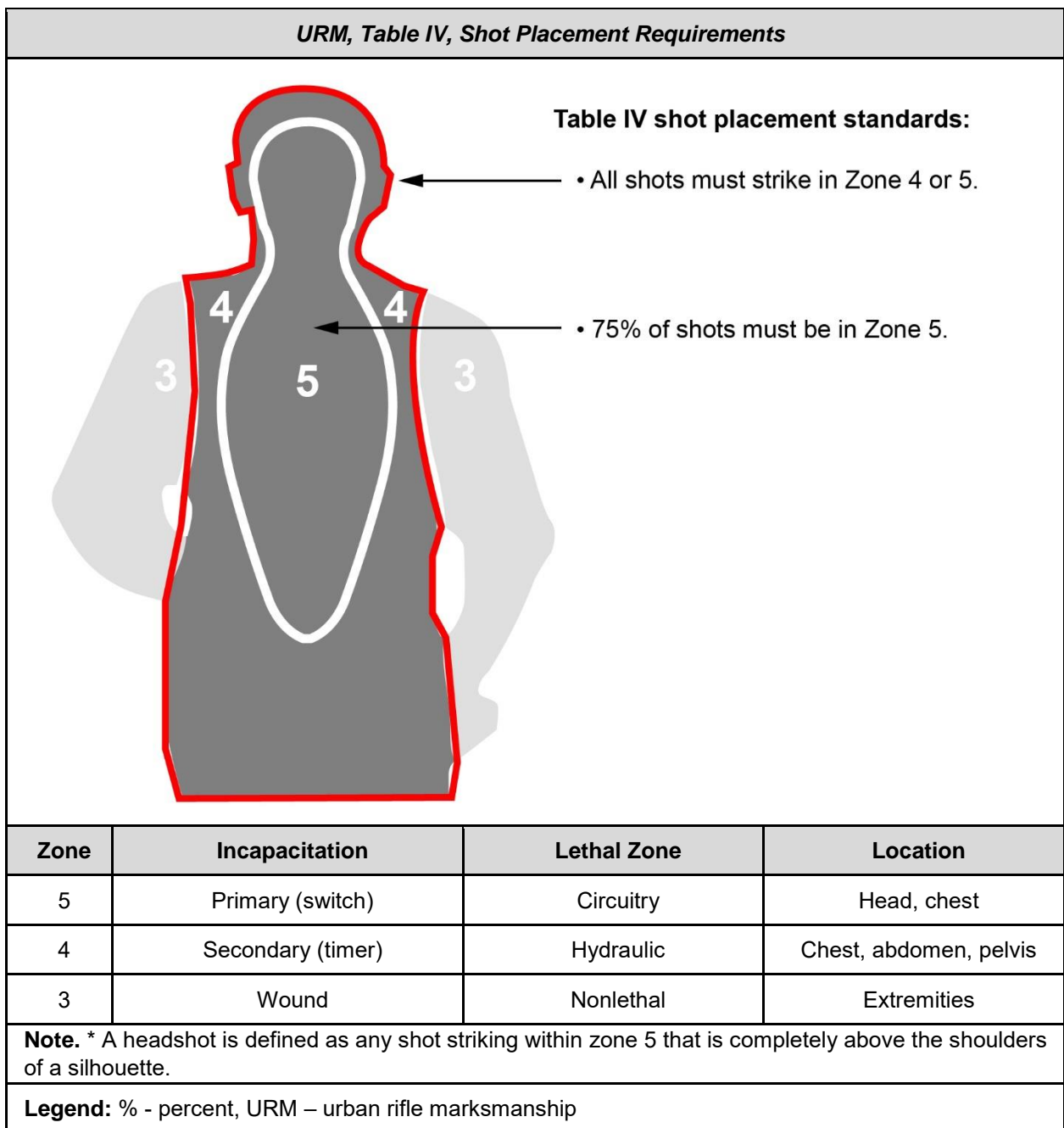

Figure H-3. Shot placement requirements example

H-40. Soldiers begin Table IV tasks by moving into the firing position following administrative commands from the tower operator. Administrative commands control the flow of the range, movement of personnel, and other command and control purposes. Table H-21 provides an example of the administrative commands for moving a new firing order into position.

H-41. Soldiers enter the range and move to their firing points. Once at the firing point, firers assume a standing firing position with weapons in a green weapons safety status. While executing Table IV tasks, firers begin each engagement at the LOW READY (see TC 3-22.9 and TC 3-22.249). On the command, MAKE READY, firers acquire the target visually while their weapon remains at the LOW READY. On the command UP, firers assume the standing, unsupported firing position, move the selector lever (safe switch for M249 automatic rifle) from SAFE to SEMI (FIRE for M249 automatic rifle), and engage the target with two consecutive shots. These shots are referred to as a “controlled pair” (two- or three-round burst for M249 automatic rifle).

Note. For simplicity, the term “controlled pair” implies two rounds from the M4- and M16-series weapons, or a three-round controlled burst from the M249 automatic rifle.

H-42. M4 and M16 firers conduct three emergency reloads without a prompt from the tower operator. The three emergency reloads occur between engagement 4 and 5, engagement 8 and 9, and engagement 12 and 13.

Table H-21. Table IV, new firing order, conduct of the range example

| New Firing Order, Conduct of the Range | | | |
|---|---|-----------------------|-----------------------|
| | Task | Target | Target Type |
| | New Firing Order | N/A | N/A |
| | Rounds per Target | DODIC | Time (Seconds) |
| | N/A | AB09 AB16 | NO LIMIT |
| TOWER | | SOLDIER ACTION | |
| CONDUCT OF THE RANGE | <p>FIRING ORDER (ONE) —</p> <p>FIRERS SECURE YOUR WEAPON AND AMMUNITION.</p> <p>ONCE COMPLETE, MOVE TO THE BASELINE.</p> <p>(ONCE SET)</p> <p>ADVANCE TO THE TEN-METER FIRING LINE.</p> | | |
| | <p>Soldiers secure their weapon in a GREEN status, secure their four magazines or 50 round container, and move to their designated lane at the baseline.</p> | | |
| | <p>ALL WEAPONS ARE IN A GREEN STATUS</p> | | |
| <p>Once all firers are at the 10-METER FIRING LINE, the tower continues.</p> | | | |
| <p>Legend: DODIC – Department of Defense identification code, N/A – not applicable</p> | | | |

H-43. As soon as the tower operator confirms all firers are at the appropriate firing point, the tower operator proceeds to the first engagement. Table H-22 provides the commands for the first engagement.

Table H-22. Urban rifle marksmanship, Table IV, engagement 1, 10-meter line, conduct of fire example

| <i>URM, Table IV, Engagement 1, 10-meter Line</i> | | | |
|--|----------------------------------|---|---------------------------------|
| | Engagement | Target | Target Type |
| | 1 | B-7 | Standing Silhouette Lethal Zone |
| | Rounds per Engagement | DODIC | Time (Seconds) |
| Controlled Pair | AB09 (2) AB16 (3) | NO LIMIT | |
| TOWER | | SOLDIER ACTION | |
| WEAPONS SAFETY STATUS RED | FIRERS LOW READY | Soldier loads one eight-round magazine or 50 round belt, verify weapon is on SAFE, and establish the LOW READY position. | |
| ENGAGEMENT / MOVEMENT | CONTACT | | |
| CONTROL | READY | Soldier identifies the sector of fire visually while remaining at the LOW READY. | |
| EXECUTION | UP | The Soldier – A – Acquires target B – Begins Shot Process C – Confirms threat D – Delivers controlled pair E – Ends the engagement | |
| TOWER AWAITS ALL FIRERS TO COMPLETE THE ENGAGEMENT THEN CONTINUES | | | |
| CONTROL | WEAPONS HOLD WEAPONS HOLD | Soldiers return to RED STATUS, LOW READY | |
| MOVEMENT | RIGHT TURN | Soldiers face to the right. The weapon may not be oriented toward the target area, depending on their dominant hand. | |
| WEAPONS SAFETY STATUS REMAINS RED | | | |
| Legend: DODIC – Department of Defense identification code, URM – urban rifle marksmanship | | | |

H-44. As soon as the tower operator confirms all firers have completed the engagement. The tower operator instructs the Soldiers to face to their right in preparation for the next engagement. Table H-23 lists the commands for the second engagement.

Table H-23. Urban rifle marksmanship, Table IV, engagement 2, 10-meter line, conduct of fire example

| <i>URM, Table IV, Engagement 2, 10-meter Line</i> | | | |
|--|--------------------------------------|---|---------------------------------|
| | Engagement | Target | Target Type |
| | 2 | B-7 | Standing Silhouette Lethal Zone |
| | Rounds per Engagement | DODIC | Time (Seconds) |
| | Controlled Pair | AB09 (2) AB16 (3) | NO LIMIT |
| TOWER | | SOLDIER ACTION | |
| WEAPON SAFETY STATUS REMAINS RED | | | |
| ENGAGEMENT / MOVEMENT | CONTACT LEFT | Soldier's head turns LEFT. | |
| CONTROL | READY | Soldier identifies the target area while remaining at the LOW READY | |
| EXECUTION | UP | The Soldier turns to the LEFT, squaring shoulders to the threat, then – A – Acquires target B – Begins Shot Process C – Confirms threat D – Delivers controlled pair E – Ends the engagement | |
| TOWER AWAITS ALL FIRERS TO COMPLETE THE ENGAGEMENT | | | |
| CONTROL | WEAPONS HOLD WEAPONS HOLD | Soldiers return to RED STATUS, LOW READY | |
| MOVEMENT | LEFT TURN | Soldier sets to the LEFT, 90-degrees from the threat. The weapon may not be oriented toward the target area, depending on their dominant hand. | |
| WEAPONS SAFETY STATUS REMAINS RED | | | |
| Legend: DODIC – Department of Defense identification code, URM – urban rifle marksmanship | | | |

H-45. As soon as the tower operator confirms all firers have completed the engagement, the tower operator instructs the Soldiers to face to their left in preparation for the next engagement. Table H-24 lists the commands for the third engagement.

Table H-24. Urban rifle marksmanship, Table IV, engagement 3, 10-meter line, conduct of fire example

| <i>URM, Table IV, Engagement 3, 10-meter Line</i> | | | |
|--|---|--|---------------------------------|
| | Engagement | Target | Target Type |
| | 3 | B-7 | Standing Silhouette Lethal Zone |
| | Rounds per Engagement | DODIC | Time (Seconds) |
| Controlled Pair | AB09 (2) AB16 (3) | NO LIMIT | |
| TOWER | | SOLDIER ACTION | |
| WEAPON SAFETY STATUS REMAINS RED | | | |
| ENGAGEMENT / MOVEMENT | CONTACT RIGHT | Soldier's head turns RIGHT. | |
| CONTROL | READY | Soldier identifies the target area while remaining at the LOW READY | |
| EXECUTION | UP | The Soldier turns to the RIGHT, squaring shoulders to the threat, then – A – Acquires target B – Begins Shot Process C – Confirms threat D – Delivers controlled pair E – Ends the engagement | |
| TOWER AWAITS ALL FIRERS TO COMPLETE THE ENGAGEMENT | | | |
| CONTROL | WEAPONS HOLD WEAPONS HOLD | Soldiers return to RED STATUS, LOW READY | |
| MOVEMENT | MOVE TO THE TWENTY-FIVE METER LINE | Soldier moves to the 25m line. | |
| | LOW READY | Soldier sets in LOW READY. | |
| WEAPONS SAFETY STATUS REMAINS RED | | | |
| Legend: DODIC – Department of Defense identification code, URM – urban rifle marksmanship | | | |

H-46. As soon as the tower operator confirms all firers have completed the engagement, the tower operator instructs the Soldiers to move to the 25-meter line in preparation for the next engagement. Table H-25 lists the commands for the fourth engagement.

Table H-25. Urban rifle marksmanship, Table IV, engagement 4, 25-meter line, conduct of fire example

| <i>URM, Table IV, Engagement 4, 25-meter Line</i> | | | |
|---|--------------------------------------|---|---------------------------------|
| | Engagement | Target | Target Type |
| | 4 | B-7 | Standing Silhouette Lethal Zone |
| | Rounds per Engagement | DODIC | Time (Seconds) |
| | Controlled Pair | AB09 (2) AB16 (3) | NO LIMIT |
| TOWER | | SOLDIER ACTION | |
| WEAPON SAFETY STATUS REMAINS RED | | | |
| ENGAGEMENT / MOVEMENT | CONTACT FRONT | | |
| CONTROL | READY | Soldier identifies the target area while remaining at the LOW READY | |
| EXECUTION | UP | The Soldier squares shoulders to the threat, then – A – Acquires target B – Begins Shot Process C – Confirms threat D – Delivers controlled pair E – Ends the engagement | |
| TOWER AWAITS ALL FIRERS TO COMPLETE THE ENGAGEMENT FIRERS PERFORM EMERGENCY RELOAD (M4/M16) | | | |
| CONTROL | WEAPONS HOLD WEAPONS HOLD | Soldiers return to RED STATUS, LOW READY | |
| MOVEMENT | RIGHT TURN | Soldiers face to the RIGHT. The weapon may not be oriented toward the target area, depending on their dominant hand. | |
| WEAPONS SAFETY STATUS REMAINS RED | | | |
| Legend: DODIC – Department of Defense identification code, URM – urban rifle marksmanship | | | |

H-47. As soon as the tower operator confirms all firers have completed the engagement, the tower operator instructs the Soldiers to move and face to their right in preparation for the next engagement. Table H-26 lists the commands for engagement 5.

Table H-26. Urban rifle marksmanship, Table IV, engagement 5, 25-meter line, conduct of fire example

| <i>URM, Table IV, Engagement 5, 25-meter Line</i> | | | |
|--|--------------------------------------|---|---------------------------------|
| | Engagement | Target | Target Type |
| | 5 | B-7 | Standing Silhouette Lethal Zone |
| | Rounds per Engagement | DODIC | Time (Seconds) |
| | Controlled Pair | AB09 (2) AB16 (3) | NO LIMIT |
| TOWER | | SOLDIER ACTION | |
| WEAPON SAFETY STATUS REMAINS RED | | | |
| ENGAGEMENT / MOVEMENT | CONTACT LEFT | Soldier's head turns LEFT. | |
| CONTROL | READY | Soldier identifies the target area while remaining at the LOW READY | |
| EXECUTION | UP | The Soldier turns to the LEFT, squaring shoulders to the threat, then – A – Acquires target B – Begins Shot Process C – Confirms threat D – Delivers controlled pair E – Ends the engagement | |
| TOWER AWAITS ALL FIRERS TO COMPLETE THE ENGAGEMENT | | | |
| CONTROL | WEAPONS HOLD WEAPONS HOLD | Soldiers return to RED STATUS, LOW READY | |
| MOVEMENT | LEFT TURN | Soldier turns 90 degrees to the LEFT. | |
| WEAPONS SAFETY STATUS REMAINS RED | | | |
| Legend: DODIC – Department of Defense identification code, URM – urban rifle marksmanship | | | |

H-48. As soon as the tower operator confirms all firers have completed the engagement, the tower operator instructs the Soldiers to face left in preparation for the next engagement. Table H-27 lists the commands for engagement 6.

Table H-27. Urban rifle marksmanship, Table IV, engagement 6, 25-meter line, conduct of fire example

| <i>URM, Table IV, Engagement 6, 25-meter Line</i> | | | |
|--|--------------------------------------|--|---------------------------------|
| | Engagement | Target | Target Type |
| | 6 | B-7 | Standing Silhouette Lethal Zone |
| | Rounds per Engagement | DODIC | Time (Seconds) |
| | Controlled Pair | AB09 (2) AB16 (3) | NO LIMIT |
| TOWER | | SOLDIER ACTION | |
| WEAPON SAFETY STATUS REMAINS RED | | | |
| ENGAGEMENT / MOVEMENT | CONTACT RIGHT | Soldier's head turns RIGHT. | |
| CONTROL | READY | Soldier identifies the target area while remaining at the LOW READY | |
| EXECUTION | UP | The Soldier turns to the RIGHT, squaring shoulders to the threat, then – A – Acquires target B – Begins Shot Process C – Confirms threat D – Delivers controlled pair E – Ends the engagement | |
| TOWER AWAITS ALL FIRERS TO COMPLETE THE ENGAGEMENT | | | |
| CONTROL | WEAPONS HOLD WEAPONS HOLD | Soldiers return to RED STATUS, LOW READY | |
| MOVEMENT | FRONT | Soldier squares body toward the target area. | |
| WEAPONS SAFETY STATUS REMAINS RED | | | |
| Legend: DODIC – Department of Defense identification code, URM – urban rifle marksmanship | | | |

H-49. As soon as the tower operator confirms all firers have completed the engagement, the tower operator instructs the Soldiers to remain at the 25-meter line and face straight ahead in preparation for the next engagement. Table H-28 lists the commands for engagement 7 and 8.

Table H-28. Urban rifle marksmanship, Table IV, engagement 7 and 8, 25 to 15 meter line, conduct of fire example

| <i>URM, Table IV, Engagement 7 and 8, 25 to 15-meter Line, Moving</i> | | | |
|--|--------------------------------------|---|---------------------------------|
| | Engagement | Target | Target Type |
| | 7, 8 | B-7 | Standing Silhouette Lethal Zone |
| | Rounds per Engagement | DODIC | Time (Seconds) |
| Controlled Pair | AB09 (2) AB16 (3) | NO LIMIT | |
| TOWER | | SOLDIER ACTION | |
| WEAPON SAFETY STATUS REMAINS RED | | | |
| ENGAGEMENT / MOVEMENT | CONTACT FRONT | Soldier begins to move forward. | |
| CONTROL | CHEST AND HEAD TWO SHOTS EACH | Soldier identifies the target area while remaining at the LOW READY | |
| | MOVE OUT | | |
| | READY | | |
| EXECUTION | UP | The Soldier squares shoulders to the threat, then – A – Acquires target B – Begins Shot Process C – Confirms threat D – Delivers controlled pair E – Ends the engagement | |
| TOWER AWAITS ALL FIRERS TO COMPLETE THE ENGAGEMENT FIRERS PERFORM EMERGENCY RELOAD (M4/M16) | | | |
| CONTROL | WEAPONS HOLD WEAPONS HOLD | Soldiers return to RED STATUS, LOW READY | |
| MOVEMENT | ABOUT FACE | Soldier turns to the REAR, facing away from the target area. The weapon is not oriented toward the target area. | |
| WEAPONS SAFETY STATUS REMAINS RED | | | |
| Legend: DODIC – Department of Defense identification code, URM – urban rifle marksmanship | | | |

H-50. As soon as the tower operator confirms all firers have completed the engagement, the tower operator instructs the Soldiers to remain at the 15-meter line and face to the rear in preparation for the next engagement. Table H-29 lists the commands for engagement 9.

Table H-29. Urban rifle marksmanship, Table IV, engagement 9, 15-meter line, conduct of fire example

| <i>URM, Table IV, Engagements 9 and 10, 15-meter Line</i> | | | |
|--|--|--|---------------------------------|
| | Engagement | Target | Target Type |
| | 9, 10 | B-7 | Standing Silhouette Lethal Zone |
| | Rounds per Engagement | DODIC | Time (Seconds) |
| Controlled Pair | AB09 (2) AB16 (3) | NO LIMIT | |
| TOWER | | SOLDIER ACTION | |
| WEAPON SAFETY STATUS REMAINS RED | | | |
| ENGAGEMENT / MOVEMENT | CONTACT REAR | Soldier turns head slightly over nondominant shoulder. | |
| CONTROL | CHEST AND HEAD TWO SHOTS EACH | Soldier identifies the target area while remaining at the LOW READY | |
| | READY | READY | |
| EXECUTION | UP | The Soldier turns to the target area, squaring shoulders to the threat, then – A – Acquires target B – Begins Shot Process C – Confirms threat D – Delivers controlled pair E – Ends the engagement | |
| TOWER AWAITS ALL FIRERS TO COMPLETE THE ENGAGEMENT | | | |
| CONTROL | WEAPONS HOLD WEAPONS HOLD | Soldiers return to RED STATUS, LOW READY | |
| MOVEMENT | MOVE TO THE TEN-METER LINE, OFFSET RIGHT, FACE LEFT | Soldier moves to the 10-meter firing line offset one target form to the right, face left, and assumed a LOW READY position. | |
| WEAPONS SAFETY STATUS REMAINS RED | | | |
| Legend: DODIC – Department of Defense identification code, URM – urban rifle marksmanship | | | |

H-51. As soon as the tower operator confirms all firers have completed the engagement, the tower operator instructs the Soldiers to move to the 10-meter line and face to the left in preparation for the next engagement. Table H-30 lists the commands for engagement 11.

Table H-30. Urban rifle marksmanship, Table IV, engagement 11, 10-meter line, conduct of fire example

| <i>URM, Table IV, Engagement 11, 10-meter Line</i> | | | |
|--|--------------------------------------|---|---------------------------------|
| | Engagement | Target | Target Type |
| | 11 | B-7 | Standing Silhouette Lethal Zone |
| | Rounds per Engagement | DODIC | Time (Seconds) |
| Controlled Pair | AB09 (2) AB16 (3) | NO LIMIT | |
| TOWER | | SOLDIER ACTION | |
| WEAPON SAFETY STATUS REMAINS RED | | | |
| MOVEMENT | MOVE OUT | Soldier begins moving to their RIGHT. | |
| ONCE OFFSET FROM THE TARGET, TOWER CONTINUES. | | | |
| CONTROL | READY | Soldier identifies the target area while remaining at the LOW READY | |
| EXECUTION | UP | The Soldier turns to the left, squaring shoulders to the threat, then – A – Acquires target B – Begins Shot Process C – Confirms threat D – Delivers controlled pair E – Ends the engagement | |
| TOWER AWAITS ALL FIRERS TO COMPLETE THE ENGAGEMENT | | | |
| CONTROL | WEAPONS HOLD WEAPONS HOLD | Soldiers return to RED STATUS, LOW READY | |
| MOVEMENT | FRONT | Soldier assumes a STANDING, UNSUPPORTED position. | |
| WEAPONS SAFETY STATUS REMAINS RED | | | |
| Legend: DODIC – Department of Defense identification code, URM – urban rifle marksmanship | | | |

H-52. As soon as the tower operator confirms all firers have completed the engagement. The tower operator instructs the Soldiers to face to the right in preparation for the next engagement. Table H-31 lists the commands for engagement 12.

Table H-31. Urban rifle marksmanship, Table IV, engagement 12, 10-meter line, conduct of fire example

| <i>URM, Table IV, Engagement 12, 10-meter Line</i> | | | |
|--|---|---|---------------------------------|
| | Engagement | Target | Target Type |
| | 12 | B-7 | Standing Silhouette Lethal Zone |
| | Rounds per Engagement | DODIC | Time (Seconds) |
| Controlled Pair | AB09 (2) AB16 (3) | NO LIMIT | |
| TOWER | SOLDIER ACTION | | |
| WEAPON SAFETY STATUS REMAINS RED | | | |
| MOVEMENT | MOVE OUT | Soldier begins moving to their LEFT. | |
| ONCE OFFSET FROM THE TARGET, TOWER CONTINUES. | | | |
| CONTROL | READY | Soldier identifies the target area while remaining at the LOW READY | |
| EXECUTION | UP | The Soldier turns to the left, squaring shoulders to the threat, then – A – Acquires target B – Begins Shot Process C – Confirms threat D – Delivers controlled pair E – Ends the engagement | |
| TOWER AWAITS ALL FIRERS TO COMPLETE THE ENGAGEMENT FIRERS PERFORM EMERGENCY RELOAD (M4/M16) | | | |
| CONTROL | WEAPONS HOLD WEAPONS HOLD | Soldiers return to RED STATUS, LOW READY | |
| MOVEMENT | MOVE TO THE TWENTY-FIVE-METER LINE | Soldier moves to the 25-meter firing line and assumes a STANDING, UNSUPPORTED position, LOW READY. | |
| WEAPONS SAFETY STATUS REMAINS RED | | | |
| Legend: DODIC – Department of Defense identification code, URM – urban rifle marksmanship | | | |

H-53. As soon as the tower operator confirms all firers have completed the engagement, the tower operator instructs the Soldiers to move to the 25-meter firing line in preparation for the next engagement. Table H-32 lists the commands for engagements 13 and 14.

Table H-32. Urban rifle marksmanship, Table IV, engagement 13 and 14, 25-meter to 5-meter line, conduct of fire example

| <i>URM, Table IV, Engagement 13 and 14, 25- to 5-meter Line</i> | | | |
|--|--|--|---------------------------------|
| | Engagement | Target | Target Type |
| | 13, 14 | B-7 | Standing Silhouette Lethal Zone |
| | Rounds per Engagement | DODIC | Time (Seconds) |
| | Controlled Pair | AB09 (4) AB16 (6) | NO LIMIT |
| TOWER | | SOLDIER ACTION | |
| WEAPON SAFETY STATUS REMAINS RED | | | |
| ENGAGEMENT / MOVEMENT | CONTACT FRONT 15 AND 5 METERS | Soldier prepares to run to the 15m then 5m firing lines. | |
| CONTROL | MAKE READY | Soldier identifies the target area while remaining at the LOW READY | |
| EXECUTION | MOVE | The Soldier moves swiftly to the 15m line, squares shoulders to the threat, then – A – Acquires target B – Begins Shot Process C – Confirms threat D – Delivers controlled pair Moves to 5m firing line, then A – Acquires target B – Begins Shot Process C – Confirms threat D – Delivers controlled pair E – Ends the engagement | |
| TOWER AWAITS ALL FIRERS TO COMPLETE THE ENGAGEMENT | | | |
| CONTROL | WEAPONS HOLD WEAPONS HOLD | Soldiers return to RED STATUS, LOW READY at the 5-meter line. | |
| WEAPONS SAFETY STATUS REMAINS RED | | | |
| Legend: DODIC – Department of Defense identification code, URM – urban rifle marksmanship | | | |

H-54. As soon as the tower operator confirms all firers have completed the engagement, the tower operator instructs the Soldiers to return to the 5-meter firing line in preparation for the next engagement. Table H-33 lists the commands for engagement 15 and 16.

Table H-33. Urban rifle marksmanship, Table IV, engagement 15 and 16, 15-meter line, conduct of fire example

| <i>URM, Table IV, Engagement 15 and 16, 5-meter Line</i> | | | |
|--|------------------------------|---|---------------------------------|
| | Engagement | Target | Target Type |
| | 15, 16 | B-7 | Standing Silhouette Lethal Zone |
| | Rounds per Engagement | DODIC | Time (Seconds) |
| | Controlled Pair | AB09 (4) AB16 (6) | NO LIMIT |
| TOWER | | SOLDIER ACTION | |
| WEAPON SAFETY STATUS REMAINS RED | | | |
| ENGAGEMENT / MOVEMENT | CONTACT FRONT | Soldier identifies the target area while remaining at the LOW READY | |
| CONTROL | CHEST AND HEAD | | |
| | TWO SHOTS EACH | | |
| | READY | | |
| EXECUTION | UP | The Soldier turns to the left, squaring shoulders to the threat, then – A – Acquires target B – Begins Shot Process C – Confirms threat D – Delivers controlled pair E – Ends the engagement | |
| TOWER AWAITS ALL FIRERS TO COMPLETE THE ENGAGEMENT | | | |
| TERMINATION | CEASEFIRE | Soldiers return to RED STATUS, LOW READY | |
| | CEASEFIRE | | |
| WEAPONS SAFETY STATUS GREEN | GO GREEN | Soldier clears the weapon and awaits for the commands from the tower. | |
| | GO GREEN | | |
| Legend: DODIC – Department of Defense identification code, URM – urban rifle marksmanship | | | |

H-55. A lane safety clears the Soldiers upon completion of Table IV and recovering their targets. A lane safety verifies the clearing prior to the Soldier moving from the firing point. Once the Soldiers have cleared, the lane safety communicates the WSS to the tower operator and the tower operator issues an administrative command moving the Soldiers off the range. Table H-34 is an example of these commands.

Table H-34. Table IV, completed firing order, conduct of the range example

| Completed Firing Order, Conduct of the Range | | | |
|---|--|-----------------------|-----------------------|
| | Task | Target | Target Type |
| | Completed Firing Order | N/A | N/A |
| | Rounds per Target | DODIC | Time (Seconds) |
| | N/A | N/A | NO LIMIT |
| TOWER | | SOLDIER ACTION | |
| FIRERS ARE IN A GREEN STATUS | | | |
| ONCE ALL FIRERS ARE COMPLETE, THE TOWER CONTINUES | | | |
| CONDUCT OF THE RANGE | MOVE TO YOUR TARGET AND REVIEW YOUR SHOTS REPLACE ALL TARGETS | | |
| ONCE COMPLETE, THE TOWER CONTINUES | | | |
| CONDUCT OF THE RANGE | SECURE YOUR DUNNAGE AND TARGET ONCE COMPLETE MOVE TO THE BASELINE | | |
| Firers secure weapon, ammunition dunnage, and target and move to the designated location. | | | |
| FIRERS ARE IN A GREEN STATUS | | | |
| ONCE ALL FIRERS ARE AT THE BASELINE, TOWER CONTINUES. | | | |
| Legend: DODIC – Department of Defense identification code, N/A – not applicable | | | |

H-56. Lane safeties annotate the number of hits in the lethal and high lethal. They annotate any misses, remove the targets, and install new ones for the next firing order. Afterward, the firers secure all dunnage between the firing points. As soon as the lane safety clears the completed firing order, the tower operator moves a new firing order into position and the process repeats itself until all firers have successfully completed Table IV training.

URBAN RIFLE MARKSMANSHIP, TABLE V, PRACTICE

H-57. Urban Rifle Marksmanship, Table V, Practice, is a live-fire event used in preparation for the certification course of fire. Table V purposefully challenges firers with single static targets from the standing, unsupported firing position and while moving within close quarters range. Leaders use Table V to train the firer to engage single, stationary, and close quarters targets while applying the functional elements of the shot process. In a timed scenario, the firer experiences and learns urban marksmanship engagement techniques, movement, and weapons manipulation. Leaders conduct Table V tasks on a basic 10 meter and 25 meter firing range (zero) or other approved facility. Soldiers fire the tasks listed in Table V in the standing position or while moving.

H-58. Unlike the conduct of fire used previously during rifle training and qualification, URM uses simplified commands delivered at a moderate or rapid tempo. The commands provided to the Soldier during URM describe the engagement or movement technique. Instructions to the firer are followed by two subsequent commands, READY and UP. READY is the preparatory command, and UP is the command of execution during this event.

H-59. All firer's participating in Table V must have previously zeroed and qualified the weapon with associated aiming devices and completed URM, Table IV. If the firer has made any changes to the weapon or primary optic or aiming device, the firer must confirm zero at 25 meters prior to executing Table V.

TASK, CONDITIONS, AND STANDARD

H-60. Table H-35 outlines the task, conditions, and standard for the conduct of Table V. The firer conducting the event should know the task, conditions, and standard and should explain them during the conduct of the range briefing.

Table H-35. Urban rifle marksmanship, Table V, Practice

| | |
|--------------------|---|
| Task: | Demonstrate lethal shot placement proficiency with the M4, M16, or M249 automatic rifle. |
| Conditions: | Given the following: <ul style="list-style-type: none"> • Fully mission capable weapon. • Magazine pouches. • Magazines. • Authorized range facility. • Full-caliber ammunition. • Approved targetry. |
| Standard: | Achieve 70-percent minimum hits (28 of 40 for M4 / M16 or 35 of 50 for M249 automatic rifle) inside the lethal zone on the B-7 target. |

H-61. Table H-36 shows the training event design template for URM, Table V, Practice. Units conduct this event on an authorized live-fire facility, typically a basic 10-meter or 25-meter firing range (zero). See TC 25-8 for additional information on authorized range facilities.

Table H-36. Training event design template for urban rifle marksmanship, Table V, Practice

| <i>URM, Table V, Practice</i> | | | | | | |
|---|----------------------------|---------------------|-----------|----------------------|--------------|---------------------------------|
| EVENT NAME: | PRACTICE | ENVIRONMENT: | LIVE | 1.0 | | |
| WEAPON: | M4, M16, M249 | CONDITIONS: | LIVE FIRE | | | |
| CATEGORY: | CERTIFICATION | PRIMARY FACILITY: | Zero | DAYS REQUIRED | | |
| PUBLICATION: | TC 3-22.9 / TC 3-22.249 | ALTERNATE FACILITY: | QTR | | | |
| REQUIRED: | YES | COMPONENT: | AC | RC | 150 SOLDIERS | |
| EXTERNAL EVAL: | COACH | FREQUENCY: | 2 | 1 | | |
| VALID FOR: | T-X | ANNUAL DAYS TOTAL: | 2 | 1 | THROUGHPUT | |
| TABLE | | | | | | |
| I | | II | | III | | IV |
| PMI&E | | PLFS | | DRILLS | | BASIC |
| PRQ | | PRQ | | PRQ | | PRACTICE |
| | | | | | | 1.0 |
| WHEN EXECUTED: | | | | | T-X | |
| TNG DAYS TO QUAL | | | | | | |
| CONDEMNATION CRITERIA (CC) | | RULE 1 | | RULE 2 | | RULE 3 |
| | | RULE 4 | | RULE 5 | | RULE 6 |
| TIME | | KEY LEADER TURNOVER | | COMMANDER ASSESSMENT | | SUBORDINATE ELEMENT PROFICIENCY |
| | | | | | | SPECIALTY PROFICIENCY |
| | | | | | | STAFF SECTION PROFICIENCY |
| <p>Remarks: Each Soldier assigned to an infantry squad who will participate in a shoot house or other urban live fire collective training event will successfully complete Table V, Practice, to gain experience with and confidence in their weapon, aiming devices, and urban rifle marksmanship skill.</p> <p>Legend: AC – active component (known as active duty), CERT – certification, EVAL – evaluation, PLFS – preliminary live-fire simulation, PMI&E – preliminary marksmanship instruction and evaluation, PRQ – prerequisite, QTR – qualification training range, RC – Reserve Component (known as Reserves), TC – training circular, TNG DAYS TO QUAL – number of training days remaining on the critical path to weapon’s qualification, T-X – training event exercise, URM – urban rifle marksmanship, Zero – basic 10 meter / 25 meter range (zero)</p> | | | | | | |

AMMUNITION

H-62. All Infantry Soldier’s assigned to a rifle squad participating in a shoot house or other urban collective training event complete URM, Table V prior to advancing to Table VI. Leaders conduct this table to demonstrate the Soldier’s ability to place well-aimed shots at or near the intended point of impact (lethal zone) of a target consistently. This skill is critical to the success of the Soldier during training and combat.

H-63. To plan and forecast for sufficient training ammunition, the unit must refer to the ammunition requirements listed in table H-37. Units need to identify the total number of firers and should plan for unscheduled firers and necessary retraining by increasing their forecasted training ammunition appropriately.

Table H-37. Urban rifle marksmanship, Table V, Practice, ammunition authorizations

| <i>Training Event</i> | <i>DODIC</i> | <i>Nomenclature</i> | <i>Quantity</i> | <i>Remarks</i> |
|--|--------------|-----------------------------------|-----------------|----------------------------------|
| Practice | AB57 | CTG, 5.56mm: ball, M855A1 | 40 | 20 rounds day 20 rounds night |
| | AB56 | CTG, 5.56mm: ball, M855A1, linked | 100 | 50 rounds day 50 rounds night |
| Legend: CTG – cartridge, DODIC – Department of Defense identification code, mm – millimeter | | | | |

H-64. The ammunition NCO with a supporting detail (ammunition detail) loads two magazines with 10 rounds each per M4 and M16 firer. The detail must also prepare and issue belts of 50 rounds inside the belt container per M249 automatic rifle firer. This requires the ammunition detail to reuse M249 belt containers for subsequent firing orders. Leaders issue the ammunition during the night iteration in the same method as the day.

H-65. Table V is a timed event. From the command UP, the firers have 3 seconds to place a controlled pair or a two- to three-round burst into the lethal zone of the B-7 target.

Note. For simplicity, the term controlled pair implies two rounds from the M4- and M16-series weapons, or a three-round controlled burst from the M249 automatic rifle.

H-66. Leaders issue firers two, 10-round magazines for a total of 20 rounds (M4- or M16-series) or one belt container loaded with 50 linked rounds (M249 automatic rifle) to conduct the day and night phases of Table V. Table H-38 lists the ammunition breakdown for URM. Firers place the ammunition in their ammunition pouches. Staging or pre-positioning ammunition is not authorized for the conduct of Table V.

Table H-38. Urban rifle marksmanship, Table V, Practice authorized range facilities and targetry

| <i>Magazine/ Belt</i> | <i>M4 / M16</i> | <i>M249AR</i> | <i>Remarks</i> |
|--|--|--|--|
| | <i>AB57 5.56mm Ball Single</i> | <i>AB56 5.56mm Ball Linked</i> | |
| DAY | | | M4 / M16 firers engage with controlled pairs. M249AR firers engage with two- to three-round bursts. |
| 1 | 10 | 50 | |
| 2 | 10 | | |
| NIGHT | | | |
| 1 | 10 | 50 | |
| 2 | 10 | | |
| Total | 40 | 100 | |
| Legend: M249AR – automatic rifle, mm – millimeter | | | |

RANGE FACILITIES

H-67. Table H-39 shows the Army-standard range facilities designed to support URM, Table V, Practice. Units reference their installation's range operations SOPs or local training regulation to identify the weapon-specific range facilities on the supporting installation. Units use their RFMSS system for all scheduling.

Table H-39. Urban rifle marksmanship Table V, Practice authorized range facilities and targetry

| Range to Target | Targetry | Range Facility | |
|---|---|----------------|-----|
| | | Zero | QTR |
| 5 to 25 m | B-7, target silhouette: paste board, standing image 25 per box NSN 6920-00-951-3956 | P | A |
| Legend: A – alternate facility, P – primary facility, m – meter, QTR – automated qualification training range, NSN – national stock number, Zero – basic 10 meter / 25 meter firing range (zero) | | | |

TARGETRY

H-68. Table V requires the use of the targets as shown in figure H-4. The target is placed on a frame with backer board at the 25-meter line. During the preparation phase, leaders should be familiar with the targetry used, the target frames and their proper emplacement, and the firing sequence of the engagements. Figure H-4 shows the authorized target used during Table V.

| URM, Table IV Targetry | |
|---|---|
|  |  |
| <p>B-7, target silhouette: paste board, standing image 25 per box NSN 6920-00-951-3956</p> | <p>Note: Units may use as many B-7 targets as needed to suit the instruction. This example provides one target for each firer.</p> |
| <p>Legend: NSN – national stock number, URM – urban rifle marksmanship</p> | |

Figure H-4. Table V target requirements example

H-69. The paste board target is secured on a target frame's backer board. The target is used in the following sequence during the DAY and NIGHT phases:

- Engagement 1 is fired from the 5-meter line.
- Engagements 2 and 3 are fired from the 10-meter line.
- Engagements 4 and 5 are fired from the 10-meter line while walking perpendicular to the target left and right.
- Engagement 6 is fired from the 25-meter line.
- Engagement 7 is fired between the 25- and 20-meter lines during the run, stop, and shoot.
- Engagement 8 is fired between the 25- and 15-meter lines during the run, stop, and shoot.
- Engagement 9 is fired from the 15-meter line.
- Engagement 10 is fired between the 15- and 10-meter lines while walking straight ahead.

H-70. All firing positions are described as distances from the target. The range NCOIC with the target detail installs the required targetry and identifies and marks the engagement distances in five-meter increments as shown in figure H-5.

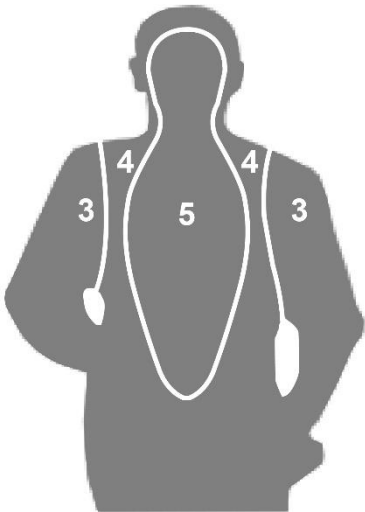
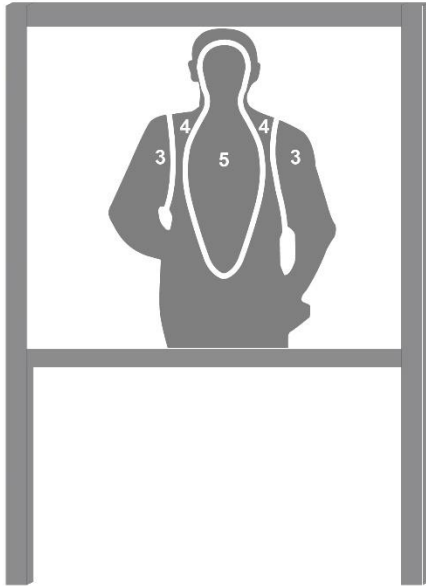
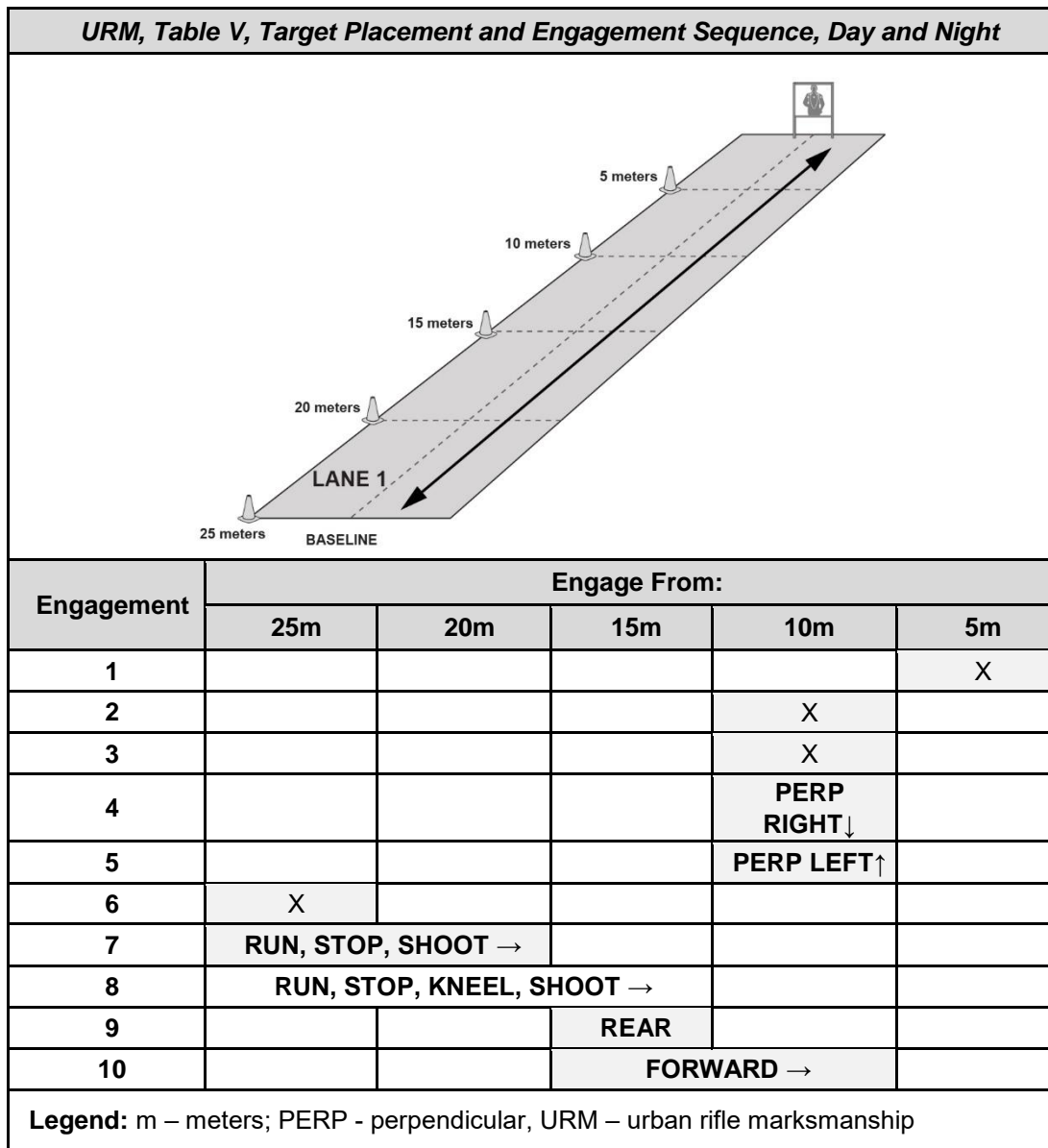

Figure H-5. Target emplacement with engagement distances example

CONDUCT OF THE RANGE

H-71. Leaders instruct Soldiers on the objectives of URM and the importance of the functional elements of the shot process (see TC 3-22.9 for more information). Table V is conducted using 10 separate engagements from various distances (range lines), with 2-rounds fired during each engagement, during both the day and night phases. Soldiers complete the engagements in the sequence shown in table H-40.

Table H-40. Urban rifle marksmanship, Table V, firing sequence example

| Magazine | Engagement | Range Line | M4 / M16 | M249AR | Engagement/ Movement |
|--|------------|------------|-------------------------------|-------------------------------|-----------------------------|
| | | | AB57 5.56mm Ball Single | AB56 5.56mm Ball Linked | |
| 1 | 1 | 5 | 2 | 3-5 | Standing straight ahead |
| | 2 | 10 | 2 | 3-5 | Standing left turn |
| | 3 | 10 | 2 | 3-5 | Standing right turn |
| | 4 | 10 | 2 | 3-5 | Walking perpendicular right |
| | 5 | 10 | 2 | 3-5 | Walking perpendicular left |
| Emergency Reload (M4 / M16) | | | | | |
| 2 | 6 | 25 | 2 | 3-5 | Standing straight ahead |
| | 7 | 25 → 20 | 2 | 3-5 | Run, stop and shoot |
| | 8 | 25 → 15 | 2 | 3-5 | Run, stop, kneel, and shoot |
| | 9 | 15 | 2 | 3-5 | Target to Rear |
| | 10 | 15 → 10 | 2 | 3-5 | Walking straight ahead |
| Note: M249AR firers do not conduct an emergency reload. | | | | | |
| Legend: M249AR – automatic rifle, mm – millimeter | | | | | |

H-72. The following guidelines are followed to properly evaluate URM, Table V. The firer must—

- Place 75-percent of shots fired in lethal zone 5 (primary, switch). Leaders use lethal zone engagements to train the Soldier to engage the most vulnerable area of an enemy that is equipped with or without body armor, with focus on the chest cavity, neck, spinal column, and brain.
- Place all rounds fired impact in either the primary (circuitry) or secondary (timer) zones on the B-7 target, zones 4 and 5, respectively.

H-73. Any shot impacting outside of the silhouette results in an automatic NO-GO when using Table V. Figure H-6 shows a description of the required shot placements during the engagement sequence.

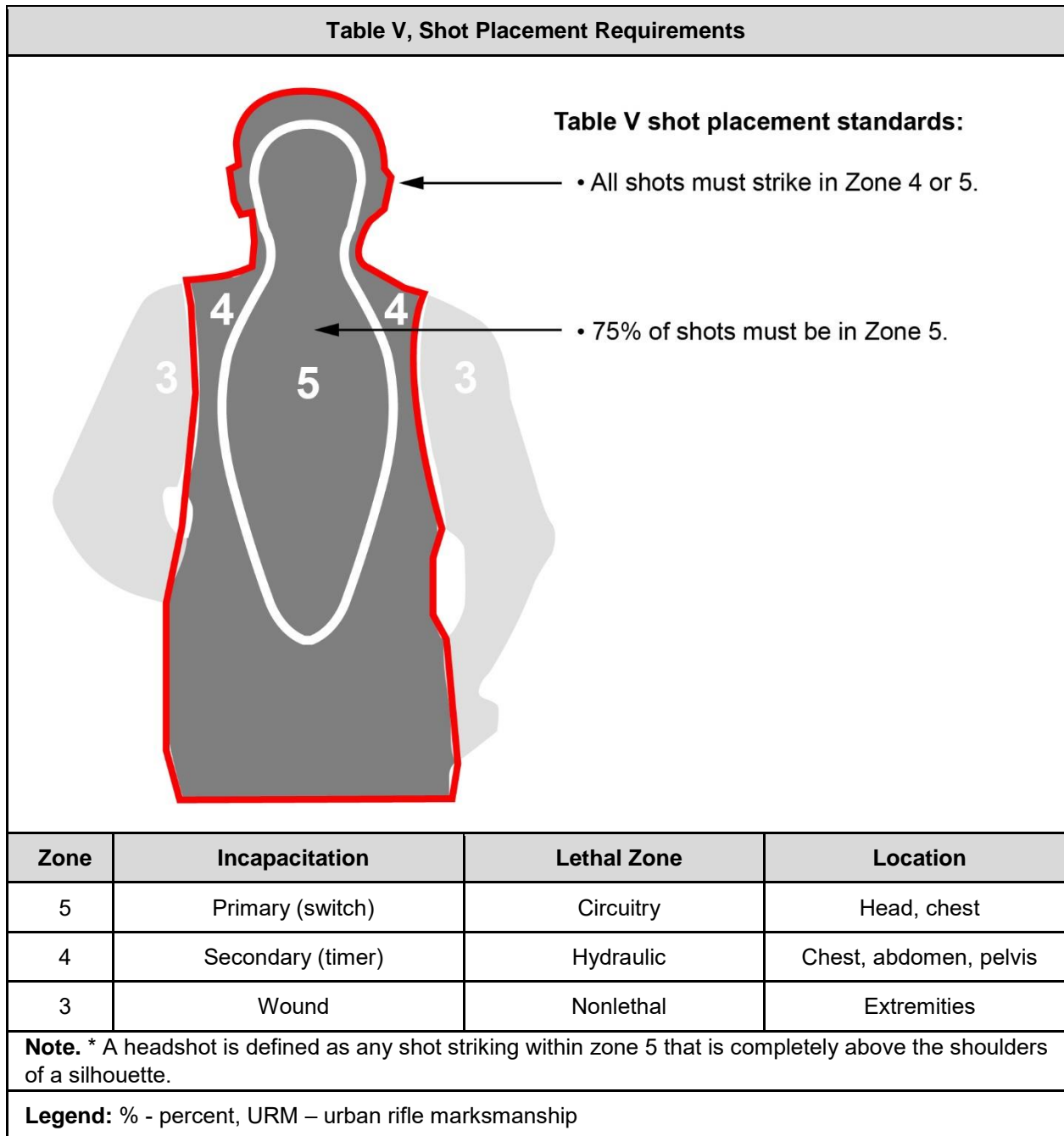

Figure H-6. Shot placement requirements example

H-74. Soldiers begin Table V tasks by moving into the firing position with the use of administrative commands from the tower operator. Tower operators use administrative commands to control the flow of the range, movement of personnel, and other command and control purposes. Table H-41 provides an example of the administrative commands for moving a new firing order into position.

H-75. Soldiers enter the range and move to their firing points. Once at the firing point, firers assume a standing firing position with weapons in a green weapons safety status. During Table V training, firers begin

each engagement at the low ready. On the command READY, firers acquire the target visually while their weapon remains at the low ready. On the command UP, firers assume the standing unsupported firing position, move the sector lever (switch for M249AR) from SAFE to SEMI (FIRE for M249 automatic rifle), and engage the target with two consecutive shots. These two consecutive shots are referred to as a controlled pair (two- or three-round burst for M249 automatic rifle). M4 and M16 firers will conduct an emergency reload without a prompt from the tower operator. The emergency reload occurs between engagement 5 and 6.

Table H-41. Table V, new firing order, conduct of the range example

| New Firing Order, Conduct of the Range | | | |
|--|---|-----------------------|-----------------------|
| <p>The diagram illustrates a range layout starting from a 'BASELINE' at 25 meters. Firing lines are marked at 5, 10, 15, and 20 meters. A 'START POSITION FRONTAL' is indicated. Two target silhouettes are shown at the end of the range.</p> | Task | Target | Target Type |
| | New Firing Order | N/A | N/A |
| | Rounds per Target | DODIC | Time (Seconds) |
| | N/A | AB57 AB56 | NO LIMIT |
| TOWER | | SOLDIER ACTION | |
| CONDUCT OF THE RANGE | <p>FIRING ORDER (ONE) —</p> <p>FIRERS SECURE YOUR WEAPON AND AMMUNITION.</p> <p>ONCE COMPLETE, MOVE TO YOUR FIRING POINT.</p> <p>(ONCE SET)</p> <p>ADVANCE TO THE FIVE-METER FIRING LINE.</p> | | |
| | <p>Soldiers secure their weapon in a GREEN status, secure their two ten round magazines or 50-round container, and move to their designated lane at the baseline.</p> | | |
| | <p>ALL WEAPONS ARE IN A GREEN STATUS</p> | | |
| <p>Once all firers are at the FIVE-METER FIRING LINE, the tower continues.</p> | | | |
| <p>Legend: DODIC – Department of Defense identification code, N/A – not applicable</p> | | | |

H-76. As soon as the tower operator confirms all firers are at the appropriate firing point at the 5- meter line, the tower operator proceeds to engagement 1. Table H-42 lists the commands for engagement 1.

Table H-42. Table V, engagement 1, 5-meter line, conduct of fire example

| <i>URM, Table V, Engagement 1, 5-meter Line</i> | | | |
|--|---|--|---------------------------------|
| | Engagement | Target | Target Type |
| | 1 | B-7 | Standing Silhouette Lethal Zone |
| | Rounds per Engagement | DODIC | Time (Seconds) |
| | Controlled Pair | AB57 (2) AB56 (3-5) | 3 |
| TOWER | | SOLDIER ACTION | |
| WEAPONS SAFETY STATUS RED | FIRERS LOW READY | Soldier loads one 10-round magazine or 50-round belt, verify weapon is on SAFE, and establish the LOW READY position. | |
| ENGAGEMENT / MOVEMENT CONTROL | CONTACT FRONT READY | Soldier identifies the sector of fire visually while remaining at the LOW READY. | |
| EXECUTION | UP | The Soldier – A – Acquires target B – Begins Shot Process C – Confirms threat D – Delivers controlled pair E – Ends the engagement | |
| TOWER AWAITS ALL FIRERS TO COMPLETE THE ENGAGEMENT THEN CONTINUES | | | |
| CONTROL | WEAPONS HOLD WEAPONS HOLD | Soldiers return to RED STATUS, LOW READY | |
| MOVEMENT | MOVE TO THE TEN-METER LINE, RIGHT TURN | Soldiers move to the 10-meter line, then face to the RIGHT. The weapon may not be oriented toward the target area, depending on the firer's dominant hand. | |
| WEAPONS SAFETY STATUS REMAINS RED | | | |
| Legend: DODIC – Department of Defense identification code, URM – urban rifle marksmanship | | | |

H-77. At the completion of engagement 1, the tower instructs all firers to move to the 10-meter firing line and face to the right. Table H-43 lists the commands for engagement 2.

Table H-43. Table V, engagement 2, 10-meter line, conduct of fire example

| <i>URM, Table V, Engagement 2, 10-meter Line</i> | | | |
|--|--------------------------------------|---|---------------------------------|
| | Engagement | Target | Target Type |
| | 2 | B-7 | Standing Silhouette Lethal Zone |
| | Rounds per Engagement | DODIC | Time (Seconds) |
| | Controlled Pair | AB57 (2) AB56 (3-5) | 3 |
| TOWER | | SOLDIER ACTION | |
| WEAPON SAFETY STATUS REMAINS RED | | | |
| ENGAGEMENT / MOVEMENT | CONTACT LEFT | Soldier's head turns LEFT. | |
| CONTROL | READY | Soldier identifies the target area while remaining at the LOW READY | |
| EXECUTION | UP | The Soldier turns to the LEFT, squaring shoulders to the threat, then – A – Acquires target B – Begins Shot Process C – Confirms threat D – Delivers controlled pair E – Ends the engagement | |
| TOWER AWAITS ALL FIRERS TO COMPLETE THE ENGAGEMENT | | | |
| CONTROL | WEAPONS HOLD WEAPONS HOLD | Soldiers return to RED STATUS, LOW READY | |
| MOVEMENT | LEFT TURN | Soldier sets to the LEFT, 90-degrees from the threat area. The weapon may not be oriented toward the target area, depending on the firer's dominant hand. | |
| WEAPONS SAFETY STATUS REMAINS RED | | | |
| Legend: DODIC – Department of Defense identification code, URM – urban rifle marksmanship | | | |

H-78. As soon as the tower operator confirms all firers have completed the engagement, the tower operator instructs the Soldiers to face to their left in preparation for the next engagement. The table H-44 lists the commands for engagement 3.

Table H-44. Table V, engagement 3, 10-meter line, conduct of fire example

| <i>URM, Table V, Engagement 3, 10-meter Line</i> | | | |
|--|--------------------------------------|--|---------------------------------|
| | Engagement | Target | Target Type |
| | 3 | B-7 | Standing Silhouette Lethal Zone |
| | Rounds per Engagement | DODIC | Time (Seconds) |
| Controlled Pair | AB57 (2) AB56 (3-5) | 3 | |
| TOWER | | SOLDIER ACTION | |
| WEAPON SAFETY STATUS REMAINS RED | | | |
| ENGAGEMENT / MOVEMENT | CONTACT RIGHT | Soldier's head turns RIGHT. | |
| CONTROL | READY | Soldier identifies the target area while remaining at the LOW READY | |
| EXECUTION | UP | The Soldier turns to the RIGHT, squaring shoulders to the threat, then – A – Acquires target B – Begins Shot Process C – Confirms threat D – Delivers controlled pair E – Ends the engagement | |
| TOWER AWAITS ALL FIRERS TO COMPLETE THE ENGAGEMENT | | | |
| CONTROL | WEAPONS HOLD WEAPONS HOLD | Soldiers return to RED STATUS, LOW READY | |
| MOVEMENT | FRONTAL | Soldier assumes a STANDING, UNSUPPORTED position with shoulders squared to the target area. | |
| WEAPONS SAFETY STATUS REMAINS RED | | | |
| Legend: DODIC – Department of Defense identification code, URM – urban rifle marksmanship | | | |

H-79. As soon as the tower operator confirms all firers have completed the engagement, the tower operator instructs the Soldiers to shift to the right target emplacement. Once all firers have shifted, the tower operator directs the firers to face to the left in preparation for the next engagement. Table H-45 lists the commands for engagement 4.

Table H-45. Table V, engagement 4, 10-meter line, conduct of fire example

| <i>URM, Table V, Engagement 4, 10-meter Line</i> | | | |
|--|--------------------------------------|---|---------------------------------|
| | Engagement | Target | Target Type |
| | 4 | B-7 | Standing Silhouette Lethal Zone |
| | Rounds per Engagement | DODIC | Time (Seconds) |
| | Controlled Pair | AB57 (2) AB56 (3 to 5) | 3 |
| TOWER | SOLDIER ACTION | | |
| WEAPON SAFETY STATUS REMAINS RED | | | |
| ENGAGEMENT / MOVEMENT | CONTACT RIGHT | Soldier begins moving to FORWARD. | |
| ONCE OFFSET FROM THE TARGET, TOWER CONTINUES. | | | |
| CONTROL | READY | Soldier identifies the target area while remaining at the LOW READY | |
| EXECUTION | UP | The Soldier turns to the left, squaring shoulders to the threat, then – A – Acquires target B – Begins Shot Process C – Confirms threat D – Delivers controlled pair E – Ends the engagement | |
| TOWER AWAITS ALL FIRERS TO COMPLETE THE ENGAGEMENT | | | |
| CONTROL | WEAPONS HOLD WEAPONS HOLD | Soldiers return to RED STATUS, LOW READY | |
| MOVEMENT | FRONT | Soldier assumes a STANDING, UNSUPPORTED position with shoulders squared to the target area. | |
| WEAPONS SAFETY STATUS REMAINS RED | | | |
| Legend: DODIC – Department of Defense identification code, URM – urban rifle marksmanship | | | |

H-80. As soon as the tower operator confirms all firers have completed the engagement, the tower operator instructs the Soldiers to shift to the left one target emplacement. Once all firers have shifted, the tower operator directs the firers to face to the right in preparation for the next engagement. Table H-46 lists the commands for engagement 5.

Table H-46. Table V, engagement 5, 10-meter line, conduct of fire example

| <i>URM, Table V, Engagement 5, 10-meter Line</i> | | | |
|--|---|---|---------------------------------|
| | Engagement | Target | Target Type |
| | 5 | B-7 | Standing Silhouette Lethal Zone |
| | Rounds per Engagement | DODIC | Time (Seconds) |
| | Controlled Pair | AB57 (2) AB56 (3 to 5) | 3 |
| TOWER | SOLDIER ACTION | | |
| WEAPON SAFETY STATUS REMAINS RED | | | |
| ENGAGEMENT / MOVEMENT | CONTACT LEFT | Soldier begins moving to FORWARD. | |
| ONCE OFFSET FROM THE TARGET, TOWER CONTINUES. | | | |
| CONTROL | READY | Soldier identifies the target area while remaining at the LOW READY | |
| EXECUTION | UP | The Soldier turns to the left, squaring shoulders to the threat, then – A – Acquires target B – Begins Shot Process C – Confirms threat D – Delivers controlled pair E – Ends the engagement | |
| TOWER AWAITS ALL FIRERS TO COMPLETE THE ENGAGEMENT FIRERS PERFORM EMERGENCY RELOAD (M4/M16) | | | |
| CONTROL | WEAPONS HOLD WEAPONS HOLD | Soldiers return to RED STATUS, LOW READY | |
| MOVEMENT | MOVE TO THE TWENTY-FIVE-METER LINE | Soldier moves to the 25-meter firing line and assumes a STANDING, UNSUPPORTED position, LOW READY. | |
| WEAPONS SAFETY STATUS REMAINS RED | | | |
| Legend: DODIC – Department of Defense identification code, URM – urban rifle marksmanship | | | |

H-81. Once completed, the tower operator instructs the Soldiers to move to the 25-meter firing line in preparation for the next engagement. Table H-47 lists the commands for engagement 6.

Table H-47. Table V, engagement 6, 25-meter line, conduct of fire example

| <i>URM, Table V, Engagement 6, 25-meter Line</i> | | | |
|--|--------------------------------------|---|---------------------------------|
| | Engagement | Target | Target Type |
| | 6 | B-7 | Standing Silhouette Lethal Zone |
| | Rounds per Engagement | DODIC | Time (Seconds) |
| | Controlled Pair | AB57 (2) AB56 (3 to 5) | 3 |
| TOWER | | SOLDIER ACTION | |
| WEAPON SAFETY STATUS REMAINS RED | | | |
| ENGAGEMENT / MOVEMENT | CONTACT FRONT | | |
| CONTROL | READY | Soldier identifies the sector of fire visually while remaining at the LOW READY. | |
| EXECUTION | UP | The Soldier – A – Acquires target B – Begins Shot Process C – Confirms threat D – Delivers controlled pair E – Ends the engagement | |
| TOWER AWAITS ALL FIRERS TO COMPLETE THE ENGAGEMENT THEN CONTINUES | | | |
| CONTROL | WEAPONS HOLD WEAPONS HOLD | Soldiers return to RED STATUS, LOW READY | |
| MOVEMENT | FRONT | Soldiers maintain the LOW READY at the 25-meter firing line and await further instruction. | |
| WEAPONS SAFETY STATUS REMAINS RED | | | |
| Legend: DODIC – Department of Defense identification code, URM – urban rifle marksmanship | | | |

H-82. Once the tower operator confirms all firers have completed the engagement, the tower operator instructs the Soldier to remain at the 25-meter firing line in preparation for the next engagement. Table H-48 lists the commands for engagement 7.

Table H-48. Table V, engagement 7, 25-meter line, conduct of fire example

| <i>URM, Table V, Engagement 7, 25 to 20-meter Line, Moving</i> | | | |
|---|--|---|---------------------------------|
| | Engagement | Target | Target Type |
| | 7 | B-7 | Standing Silhouette Lethal Zone |
| | Rounds per Engagement | DODIC | Time (Seconds) |
| Controlled Pair | AB57 (2) AB56 (3 to-5) | 3 | |
| TOWER | | SOLDIER ACTION | |
| WEAPON SAFETY STATUS REMAINS RED | | | |
| ENGAGEMENT / MOVEMENT | CONTACT FRONT | Soldier begins movement forward. | |
| CONTROL | MOVE OUT READY | Soldier identifies the target area while remaining at the LOW READY | |
| EXECUTION | UP | The Soldier squares shoulders to the threat, then – A – Acquires target B – Begins Shot Process C – Confirms threat D – Delivers controlled pair E – Ends the engagement | |
| TOWER AWAITS ALL FIRERS TO COMPLETE THE ENGAGEMENT FIRERS SHOULD BE AT THE 20-METER LINE | | | |
| CONTROL | WEAPONS HOLD WEAPONS HOLD | Soldiers return to RED STATUS, LOW READY | |
| MOVEMENT | ABOUT FACE | Soldier turns to the REAR, facing away from the target area. The weapon is not oriented toward the target area. | |
| WEAPONS SAFETY STATUS REMAINS RED | | | |
| Legend: DODIC – Department of Defense identification code, URM – urban rifle marksmanship | | | |

H-83. As soon as the tower operator confirms all firers have completed the engagement, the tower operator instructs the Soldiers to move to the 20-meter firing line facing away from the target area (to the rear) in preparation for the next engagement. Table H-49 lists the commands for engagement 8.

Table H-49. Table V, engagement 8, 20-meter line, conduct of fire example

| <i>URM, Table V, Engagement 8, 20 to 15-meter Line, Moving</i> | | | |
|---|--|---|---------------------------------|
| | Engagement | Target | Target Type |
| | 8 | B-7 | Standing Silhouette Lethal Zone |
| | Rounds per Engagement | DODIC | Time (Seconds) |
| | Controlled Pair | AB57 (2) AB56 (3 to 5) | 3 |
| TOWER | | SOLDIER ACTION | |
| WEAPON SAFETY STATUS REMAINS RED | | | |
| ENGAGEMENT / MOVEMENT | CONTACT REAR | Soldier turns head slightly over nondominant shoulder. Soldier turns toward the target and begins movement forward. | |
| CONTROL | MOVE OUT READY | Soldier identifies the target area while remaining at the LOW READY | |
| EXECUTION | UP | The Soldier squares shoulders to the threat, then – A – Acquires target B – Begins Shot Process C – Confirms threat D – Delivers controlled pair E – Ends the engagement | |
| TOWER AWAITS ALL FIRERS TO COMPLETE THE ENGAGEMENT FIRERS SHOULD BE AT THE 15-METER LINE | | | |
| CONTROL | WEAPONS HOLD WEAPONS HOLD | Soldiers return to RED STATUS, LOW READY | |
| MOVEMENT | ABOUT FACE | Soldier turns to the REAR, facing away from the target area. The weapon is not oriented toward the target area. | |
| WEAPONS SAFETY STATUS REMAINS RED | | | |
| Legend: DODIC – Department of Defense identification code, URM – urban rifle marksmanship | | | |

H-84. The tower operator ensures the Soldiers are at the 15-meter firing line and facing to the rear (away from the target area) in preparation for the next engagement. Table H-50 lists the commands for engagement 9.

Table H-50. Table V, engagement 9, 15-meter line, conduct of fire example

| <i>URM, Table V, Engagement 9, 15-meter Line, Threat to Rear</i> | | | |
|---|--------------------------------------|---|---------------------------------|
| | Engagement | Target | Target Type |
| | 9 | B-7 | Standing Silhouette Lethal Zone |
| | Rounds per Engagement | DODIC | Time (Seconds) |
| Controlled Pair | AB57 (2) AB56 (3 to 5) | 3 | |
| TOWER | | SOLDIER ACTION | |
| WEAPON SAFETY STATUS REMAINS RED | | | |
| ENGAGEMENT / MOVEMENT | CONTACT REAR | Soldier turns head slightly over nondominant shoulder. Soldier turns toward the target and begins movement forward. | |
| CONTROL | MOVE OUT READY | Soldier identifies the target area while remaining at the LOW READY | |
| EXECUTION | UP | The Soldier squares shoulders to the threat, then – A – Acquires target B – Begins Shot Process C – Confirms threat D – Delivers controlled pair E – Ends the engagement | |
| TOWER AWAITS ALL FIRERS TO COMPLETE THE ENGAGEMENT FIRERS SHOULD BE AT THE 15-METER LINE | | | |
| CONTROL | WEAPONS HOLD WEAPONS HOLD | Soldiers return to RED STATUS, LOW READY | |
| MOVEMENT | ABOUT FACE | Soldier turns to the REAR, facing away from the target area. The weapon is not oriented toward the target area. | |
| WEAPONS SAFETY STATUS REMAINS RED | | | |
| Legend: DODIC – Department of Defense identification code, URM – urban rifle marksmanship | | | |

H-85. Once the tower operator confirms all firers have completed the engagement, the tower operator instructs the Soldiers to remain at the 15-meter firing line and face to the rear (away from the target area) in preparation for the next engagement. Table H-51 lists the commands for engagement 10.

Table H-51. Table V, engagement 10, 15-meter line, conduct of fire example

| <i>URM, Table V, Engagement 8, 15 to 10-meter Line, Moving</i> | | | |
|---|--------------------------------|---|---------------------------------|
| <p>The diagram illustrates the engagement setup. A soldier is positioned at a 15-meter baseline, facing away from the target area. A target is located at a 5-meter distance, and the target area is at a 10-meter distance. A silhouette of a person is shown with numbered zones (3, 4, 5). The soldier's start position is rear. The target area is marked with a cone. The target is marked with a cone. The target area is marked with a cone.</p> | Engagement | Target | Target Type |
| | 10 | B-7 | Standing Silhouette Lethal Zone |
| | Rounds per Engagement | DODIC | Time (Seconds) |
| Controlled Pair | AB57 (2) AB56 (3 to - 5) | 3 | |
| TOWER | | SOLDIER ACTION | |
| WEAPON SAFETY STATUS REMAINS RED | | | |
| ENGAGEMENT / MOVEMENT | CONTACT REAR | Soldier turns head slightly over nondominant shoulder. Soldier turns toward the target and begins movement forward. | |
| CONTROL | MOVE OUT READY | Soldier identifies the target area while remaining at the LOW READY | |
| EXECUTION | UP | The Soldier squares shoulders to the threat, then – A – Acquires target B – Begins Shot Process C – Confirms threat D – Delivers controlled pair E – Ends the engagement | |
| TOWER AWAITS ALL FIRERS TO COMPLETE THE ENGAGEMENT | | | |
| TERMINATION | CEASEFIRE CEASEFIRE | Soldiers return to RED STATUS, LOW READY | |
| WEAPONS SAFETY STATUS GREEN | GO GREEN GO GREEN | Soldier clears the weapon and awaits for the commands from the tower. | |
| Legend: DODIC – Department of Defense identification code, URM – urban rifle marksmanship | | | |

H-86. A lane safety clears the Soldiers upon completion of Table V and recovering their targets. A lane safety verifies the clearing prior to the Soldier moving from the firing point. Once the Soldiers have cleared, the lane safety communicates the WSS to the tower operator and the tower operator issues an administrative command moving the completed Soldiers off the range. Table H-52 is an example of this command.

Table H-52. Table V, completed firing order, conduct of the range example

| Completed Firing Order, Conduct of the Range | | | |
|--|--|-----------------------|---|
| | Task | Target | Target Type |
| | Completed Firing Order | N/A | N/A |
| | Rounds per Target | DODIC | Time (Seconds) |
| | N/A | N/A | NO LIMIT |
| TOWER | | SOLDIER ACTION | |
| FIRERS ARE IN A GREEN STATUS | | | |
| ONCE ALL FIRERS ARE COMPLETE, THE TOWER CONTINUES | | | |
| CONDUCT OF THE RANGE | MOVE TO YOUR TARGET AND REVIEW YOUR SHOTS REPLACE ALL TARGETS | | |
| ONCE COMPLETE, THE TOWER CONTINUES | | | |
| CONDUCT OF THE RANGE | SECURE YOUR DUNNAGE AND TARGET ONCE COMPLETE MOVE TO THE BASELINE | | Firers secure weapon, ammunition dunnage, and target and move to the designated location. |
| FIRERS ARE IN A GREEN STATUS | | | |
| ONCE ALL FIRERS ARE AT THE BASELINE, TOWER CONTINUES. | | | |
| Legend: DODIC – Department of Defense identification code, N/A – not applicable | | | |

H-87. Lane safeties annotate the number of hits in the lethal zone, annotate any misses, subtract any shots fired after the three seconds have elapsed and remove the targets. Lane safeties install new targets for the next firing order. Afterward, firers secure all dunnage between the firing points. As soon as the lane safety clears the completed firing order, the tower operator moves a new firing order into position and the process repeats itself until all firers have successfully completed Table V training. The firing sequence for the night phase is the same as the firing sequence during the day.

URBAN RIFLE MARKSMANSHIP, TABLE VI, CERTIFICATION

H-88. All Soldiers assigned to an MTOE Infantry squad, who participate in a shoot house or other urban collective live-fire event, must execute URM, Table VI, Certification. The Soldier must place 70 percent of their shots inside the zone 5 of the B-7 target, and may not have any shots strike outside zone 4 or 5. Failing to pass this table indicates the Soldier's lack of proficiency applying the functional elements of the shot process and essential elements of the URM.

H-89. Table VI, Certification, is the commander's assessment of the Soldier's weapons proficiency in an urban close quarters environment. The assessment serves as an evaluation of the Soldiers ability to engage and defeat single threats with an M4, M16, or M249 automatic rifle. In a timed scenario, the firer demonstrates their experience, efficient application of engagement and movement techniques, and understanding of target acquisition, weapons manipulation, and ability to conduct rapid reloads while stationary or moving. Table VI occurs on a basic 10 meter / 25 meter firing range (zero) or other approved facility. URM, Table, VI, contains 20 firing tasks: 10 fired during the day and 10 fired during the night.

Note. Soldiers who fail to achieve the 70 percent standard during URM, Table VI, Certification, may not progress to the shoot house or other live-fire collective training events.

TASK, CONDITIONS, AND STANDARDS

H-90. Table H-53 shows the task, conditions, and standard for the conduct of URM, Table VI, Certification. The firer conducting the event should know the task, conditions, and standard and should explain them during the conduct of the range briefing.

Table H-53. Urban rifle marksmanship, Table VI, Certification

| | |
|--------------------|---|
| Task: | Demonstrate lethal shot placement proficiency with the M4, M16, or M249 automatic rifle. |
| Conditions: | Given the following: <ul style="list-style-type: none"> Fully mission capable weapon, magazine pouches, and magazines. Authorized range facility, full-caliber ammunition, and approved targetry. |
| Standard: | Achieve a minimum hits of 28 of 40 (M4 / M16) or 35 of 50 (M249 automatic rifle) inside the lethal zone on the B7 target (the lethal zone of the B7 target is the area on the target indicated with the number 5). |

H-91. Table H-54 shows the training event design template for URM, Table VI, Certification. Leaders conduct this event on an authorized live-fire facility, typically a basic 10 meter and 25 meter firing range (zero). See TC 25-8 for additional information on authorized range facilities.

Table H-54. Training event design template for urban rifle marksmanship, Table VI, Certification

| URM, Table VI, Certification Live-Fire Proficiency Gate | | | | | | |
|--|----------------------------|---------------------------|-------------------------|---------------------------------------|--------------------------|---------------------------------|
| EVENT NAME: | CERTIFICATION | ENVIRONMENT: | LIVE | 1.0 | | |
| WEAPON: | M4, M16, M249AR | CONDITIONS: | LIVE FIRE | | | |
| CATEGORY: | FOUNDATION | PRIMARY FACILITY: | Zero | DAYS REQUIRED | | |
| PUBLICATION: | TC 3-22.9 / TC 3-22.249 | ALTERNATE FACILITY: | QTR | | | |
| REQUIRED: | YES | COMPONENT: | AC | RC | 150 SOLDIERS | |
| EXTERNAL EVAL: | PLATOON | FREQUENCY: | 2 | 1 | | |
| VALID FOR: | 12 MONTHS | ANNUAL DAYS TOTAL: | 2 | 1 | THROUGHPUT | |
| TABLE | | | | | | |
| | I | II | III | IV | V | VI |
| | PMI&E | PLFS | DRILLS | BASIC | PRACTICE | CERT |
| | PRQ | PRQ | PRQ | REQ | REQ | REQUIRED |
| WHEN EXECUTED: | | | | | | T-X |
| CONDEMNATION CRITERIA (CC) | RULE 1 | RULE 2 | RULE 3 | RULE 4 | RULE 5 | RULE 6 |
| | TIME | KEY LEADER TURNOVER | COMMANDER ASSESSMENT | SUBORDINATE ELEMENT PROFICIENCY | SPECIALTY PROFICIENCY | STAFF SECTION PROFICIENCY |
| Remarks: Each Soldier assigned to an MTOE Infantry squad that will participate in a shoot house or other collective live-fire training event <i>must</i> successfully complete Table VI, Certification to meet their live-fire proficiency gate. | | | | | | |
| Note: Table III should be used as concurrent training on Tables IV, V, and VI while Soldiers are awaiting training in a firing order or between day and night phases. | | | | | | |
| Legend: AC – active component (known as active duty), ARF – automated record fire range, M249AR – automatic rifle, EVAL – evaluation, MRF – modified record fire range or similar, MTOE – modification table of organization and equipment, PLFS – preliminary live-fire simulation, PMI&E – preliminary marksmanship instruction and evaluation, PRQ – prerequisite, QTR – qualification training range, RC – Reserve Component (known as Reserves), REQ – required, TC – training circular, T-X – training event exercise, TNG DAYS TO QUAL – number of training days remaining on the critical path to weapon’s qualification, URM – urban rifle marksmanship, Zero – basic 10 meter / 25 meter range (zero) | | | | | | |

AMMUNITION

H-92. All Soldiers assigned to an MTOE Infantry squad, who participate in a shoot house or other urban collective live-fire event must complete URM, Table VI prior to conducting those events. URM, Table VI, Certification is a prerequisite for any shoot house or collective live-fire training event. The purpose of URM, Table VI is to certify the Soldier's proficiency to lethally employ an M4, M16, or M249 automatic rifle during a close-quarters fight prior to conducting high-risk live-fire events in urban or close quarter's environments.

H-93. To effectively plan and forecast for sufficient training ammunition, the unit must refer to the ammunition requirements listed in table H-55. Units need to identify the total number of firers and should plan for unscheduled firers and necessary retraining by increasing their forecasted training ammunition.

Table H-55. Urban rifle marksmanship, Table VI, Certification, ammunition authorizations

| <i>Training Event</i> | <i>DODIC</i> | <i>Nomenclature</i> | <i>Quantity</i> | <i>Remarks</i> |
|--|--------------|-----------------------------------|-----------------|----------------------------------|
| Practice | AB57 | CTG, 5.56mm: ball, M855A1 | 40 | 20 rounds day 20 rounds night |
| | AB56 | CTG, 5.56mm: ball, M855A1, linked | 100 | 50 rounds day 50 rounds night |
| Legend: CTG – cartridge, DODIC – Department of Defense identification code, mm – millimeter | | | | |

H-94. The ammunition NCO with a supporting detail (ammunition detail) will load two magazines with 10-rounds each per M4 / M16 firer. The detail must also prepare and issue belts of 50-rounds inside the belt container per M249 automatic rifle firer. This requires the ammunition detail to reuse M249 belt containers for subsequent firing orders. Leaders issue ammunition during the night iteration in the same method as the day.

H-95. Leaders use Table VI as a timed event. From the command of UP the firers have three seconds to place a controlled pair or three-round bursts into the lethal zone of the B7 target. Leaders issue two, 10-round magazines (20 rounds total for M4- or M16-series) or one belt container loaded with 50 linked rounds (M249AR) to conduct both the day and night phase of Table VI. Table H-56, on page H-58, shows the ammunition breakdown for URM, Table VI. Firers place ammunition in their ammunition pouches. Staging or pre-positioning ammunition is not authorized for the conduct of Table VI.

Note. For simplicity, the term “controlled pair” implies two rounds from the M4- and M16-series weapons, or a three-round controlled burst from the M249 automatic rifle.

Table H-56. Urban rifle marksmanship, Table VI, ammunition breakdown per firer

| <i>Magazine / Belt</i> | <i>M4 / M16</i> | <i>M249AR</i> | <i>Remarks</i> |
|--|--|--|--|
| | <i>AB57 5.56mm Ball Single</i> | <i>AB56 5.56mm Ball Linked</i> | |
| DAY | | | M4 / M16 firers engage with controlled pairs. M249AR firers engage with two- to three-round bursts. |
| 1 | 10 | 50 | |
| 2 | 10 | | |
| NIGHT | | | |
| 1 | 10 | 50 | |
| 2 | 10 | | |
| Total | 40 | 100 | |
| Legend: M249AR – automatic rifle, mm – millimeter | | | |

RANGE FACILITIES

H-96. Table H-57 shows the Army-standard range facilities specifically designed to support URM, Table VI, Certification. Units reference their installation’s range operations SOPs or local training regulations to identify the weapon-specific range facilities on the supporting installation. Units use their RFMSS system for all scheduling.

Table H-57. Urban rifle marksmanship, Table VI, Certification, authorized range facilities and targetry

| <i>Range to Target</i> | <i>Targetry</i> | <i>Range Facility</i> | |
|---|--|-----------------------|------------|
| | | <i>Zero</i> | <i>QTR</i> |
| 5 to 25 m | B-7 target silhouette: paste board, standing image 25 per box NSN 6920-00-951-3956 | P | A |
| Legend: A – alternate facility, P – primary facility, m – meter, QTR – Automated qualification training range, NSN – national stock number, Zero – basic 10 meter / 25 meter firing range (zero) | | | |

TARGETRY

H-97. The target is placed on a frame with backer board at the 25-meter line. During the preparation phase, leaders should be familiar with the targetry used, the target frames and their proper emplacement, and the firing sequence of the engagements. Figure H-7 shows the authorized target used during Table VI.

| URM, Table VI, Certification, Targetry | |
|---|--|
|  |  |
| <p>B-7, target silhouette: paste board, standing image 25 per box</p> <p>NSN 6920-00-951-3956</p> | <p>Note: Units may use as many B-7 targets as to suit the instruction. This example provides one target for each firer.</p> |
| <p>Legend: NSN – national stock number, URM – urban rifle marksmanship</p> | |

Figure H-7. Urban Rifle Marksmanship, Table VI, targetry example

H-98. The paste board target is secured on a target frame's backer board. The target is used in the following sequence during the day and night phases:

- Engagement 1 is fired from the 5-meter line.
- Engagements 2 and 3 are fired from the 10-meter line.
- Engagements 4 and 5 are fired from the 10-meter line while walking perpendicular to the target left and right.
- Engagement 6 is fired from the 25-meter line.
- Engagement 7 is fired between the 25- and 20-meter lines during the run, stop, and shoot.
- Engagement 8 is fired between the 25- and 15-meter lines during the run, stop, kneel, and shoot.
- Engagement 9 is fired from the 15-meter line.
- Engagement 10 is fired between the 15- and 10-meter lines while walking straight ahead.

H-99. All firing positions are described as distances from the target. The range NCOIC with the target detail installs the required targetry, identifies, and marks the engagement distances in 5-meter increments as shown in figure H-8.

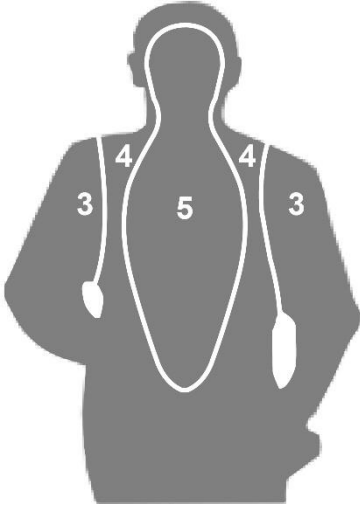
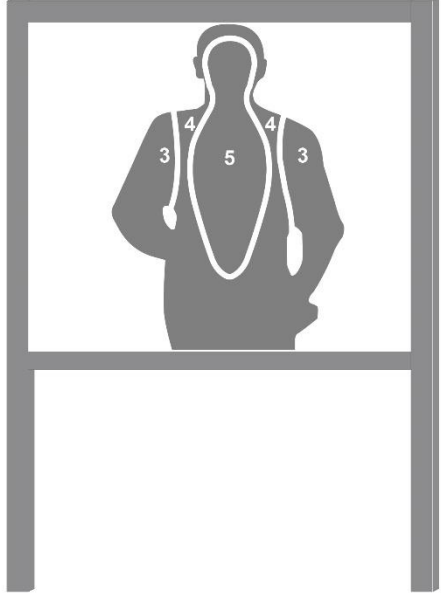
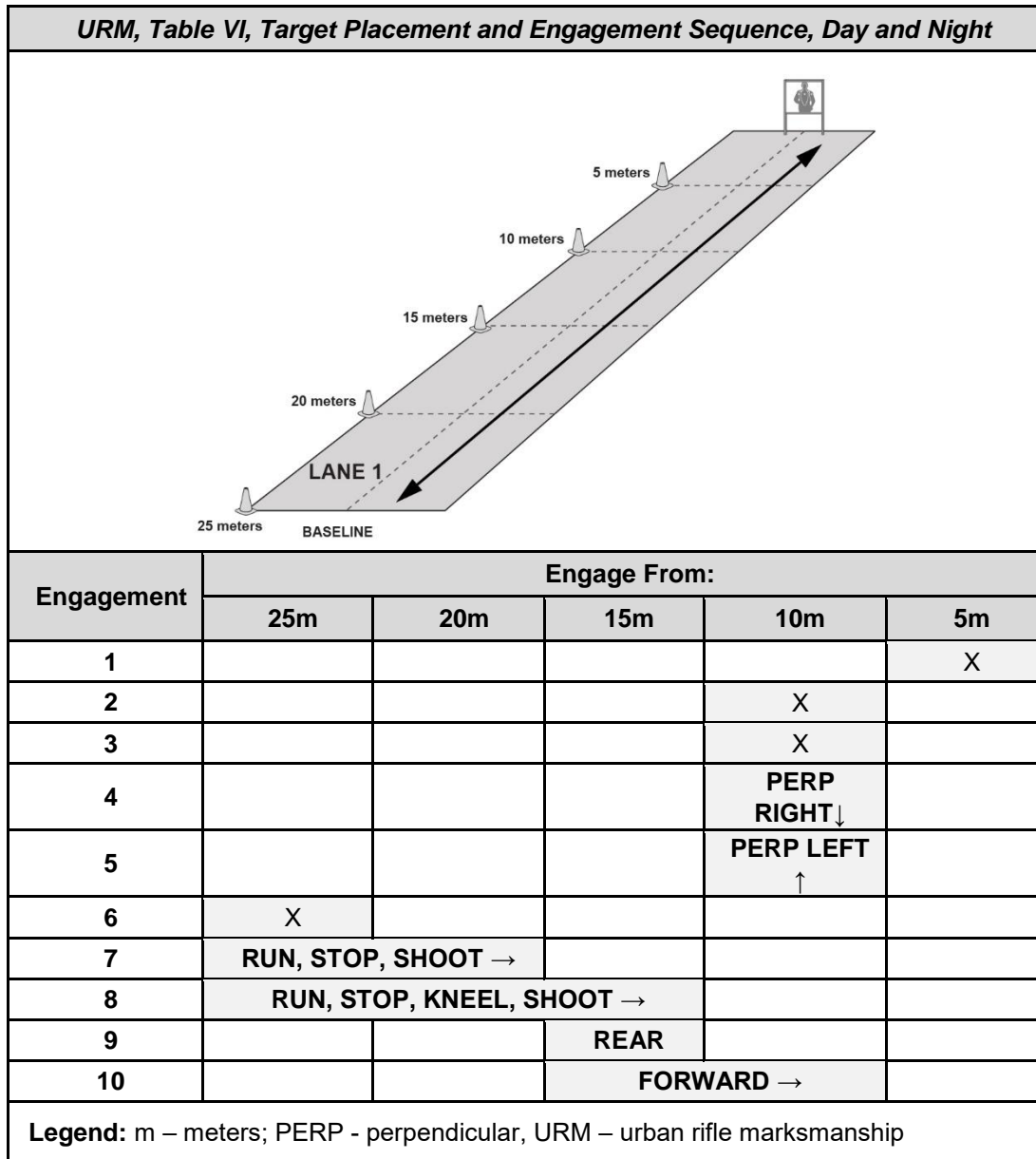

Figure H-8. Target emplacement with engagement distances example

CONDUCT OF THE RANGE

H-100. Leaders instruct Soldiers on the objectives of URM and the importance of the functional elements of the shot process (see TC 3-22.9). Soldiers conduct the 10 separate engagements in Table VI from various distances (range lines), with 2 rounds fired during each engagement, during both the day and night phases. Soldiers complete the engagements in the sequence shown in table H-58.

Table H-58. Urban rifle marksmanship, Table VI, firing sequence example

| Magazine | Engagement | Range Line | M4 / M16 | M249AR | Engagement/ Movement |
|--|------------|------------|-------------------------------|-------------------------------|-----------------------------|
| | | | AB57 5.56mm Ball Single | AB56 5.56mm Ball Linked | |
| 1 | 1 | 5 | 2 | 3-5 | Standing straight ahead |
| | 2 | 10 | 2 | 3-5 | Standing left turn |
| | 3 | 10 | 2 | 3-5 | Standing right turn |
| | 4 | 10 | 2 | 3-5 | Walking perpendicular right |
| | 5 | 10 | 2 | 3-5 | Walking perpendicular left |
| Emergency Reload (M4 / M16) | | | | | |
| 2 | 6 | 25 | 2 | 3-5 | Standing straight ahead |
| | 7 | 25 → 20 | 2 | 3-5 | Run, stop, and shoot |
| | 8 | 25 → 15 | 2 | 3-5 | Run, stop, kneel, and shoot |
| | 9 | 15 | 2 | 3-5 | Target to Rear |
| | 10 | 15 → 10 | 2 | 3-5 | Walking straight ahead |
| Note: M249AR firers do not conduct an emergency reload. | | | | | |
| Legend: M249AR – automatic rifle, mm – millimeter | | | | | |

H-101. The following guidelines are followed to properly evaluate URM, Table VI. The firer must—

- Place 75-percent of shots fired in lethal zone 5 (primary, switch). Leaders use the lethal zone engagements to train Soldiers to engage the most vulnerable area of an enemy that is equipped with or without body armor focusing on the chest cavity, neck, spinal column, and brain.
- Place all rounds fired impact in either the primary (circuitry) or secondary (timer) zones on the B-7 target, zones 4 and 5, respectively.

H-102. Any shot impacting outside of the silhouette results in an automatic NO-GO when using Table VI. Figure H-9 shows a description of the required shot placements during the engagement sequence.

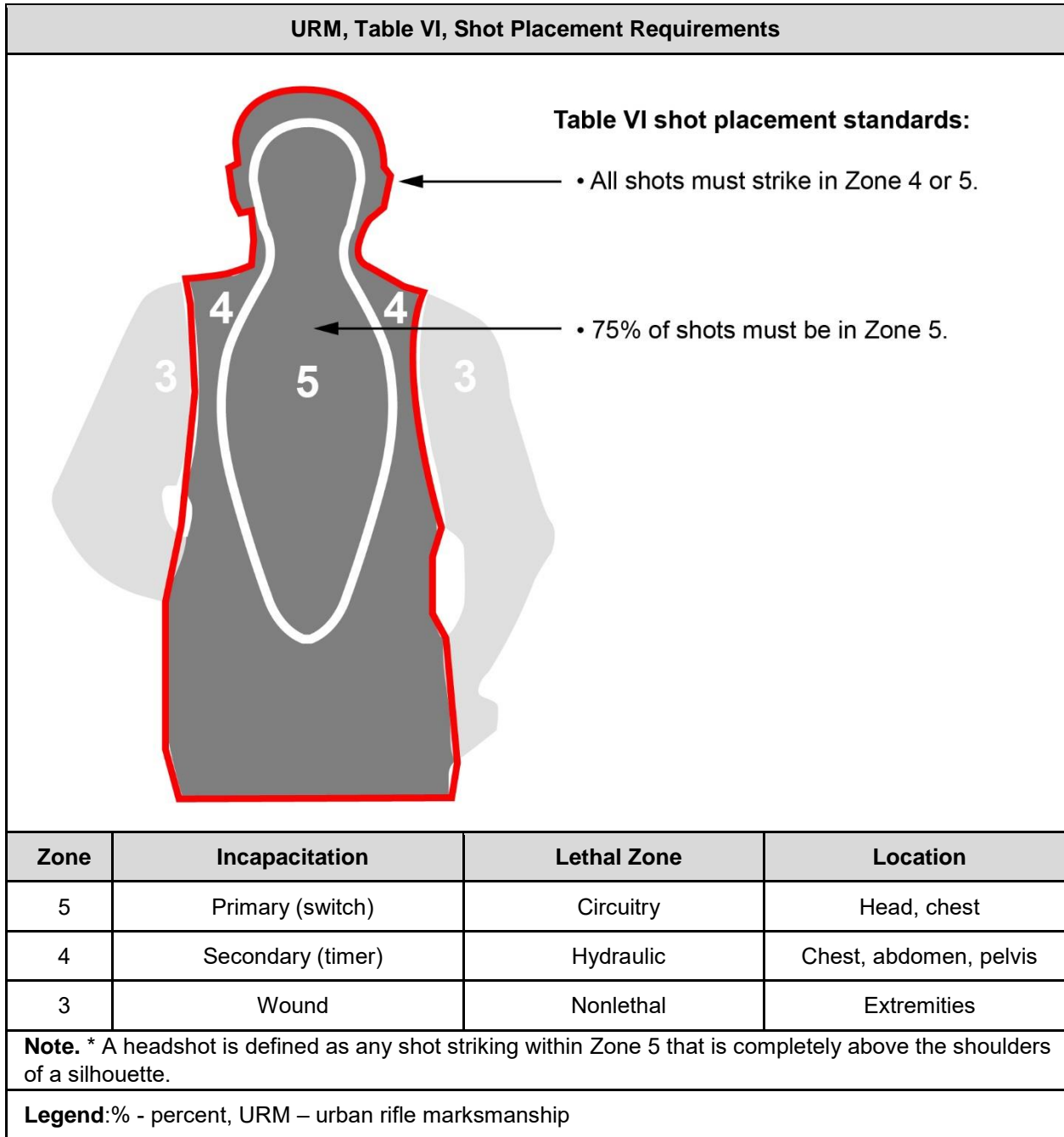

Figure H-9. Shot placement requirements example

H-103. Soldiers begin by moving into the firing position with the use of administrative commands from the tower operator. Tower operators use administrative commands control the flow of the range, movement of personnel, and other command and control purposes. Table H-59 provides an example of the administrative commands for moving a new firing order into position.

H-104. Soldiers enter the range and move to their firing points. Once at the firing point, the firers assume a standing firing position with weapons in a green weapons safety status. Firers begin each engagement at the

low ready. On the command READY firers acquire the target visually while their weapon remains at the low ready. On the command UP firers assume the standing unsupported firing position, move the sector lever (switch for M249 automatic rifle) from SAFE to SEMI (FIRE for M249 automatic rifle), and engage the target with two consecutive shots referred to as a controlled pair (two- or three-round burst for M249 automatic rifle). M4 and M16 firers conduct an emergency reload without a prompt from the tower operator. The emergency reload occurs between engagements 5 and 6.

Table H-59. Table VI, new firing order, conduct of the range example

| New Firing Order, Conduct of the Range | | | |
|--|--|-----------------------|-----------------------|
| | Task | Target | Target Type |
| | New Firing Order | N/A | N/A |
| | Rounds per Target | DODIC | Time (Seconds) |
| | N/A | AB57 AB56 | NO LIMIT |
| TOWER | | SOLDIER ACTION | |
| CONDUCT OF THE RANGE | <p>FIRING ORDER (ONE) —</p> <p>FIRERS SECURE YOUR WEAPON AND AMMUNITION.</p> <p>ONCE COMPLETE, MOVE TO YOUR FIRING POINT.</p> <p>(ONCE SET)</p> <p>ADVANCE TO THE 5-METER FIRING LINE.</p> | | |
| | <p>Soldiers secure their weapon in a GREEN status, secure their two 10-round magazines or 50-round container, and move to their designated lane at the baseline.</p> | | |
| ALL WEAPONS ARE IN A GREEN STATUS | | | |
| ONCE ALL FIRERS ARE AT THE FIVE-METER FIRING LINE, THE TOWER CONTINUES. | | | |
| Legend: DODIC – Department of Defense identification code, N/A – not applicable | | | |

H-105. As soon as the tower operator confirms all firers are at the appropriate firing point, the tower operator proceeds to the first engagement. Table H-60 provides the commands for the first engagement.

Table H-60. Table VI, engagement 1, 5-meter line, conduct of fire example

| <i>URM, Table VI, Engagement 1, 5-meter Line</i> | | | |
|--|--|--|---------------------------------|
| | Engagement | Target | Target Type |
| | 1 | B-7 | Standing Silhouette Lethal Zone |
| | Rounds per Engagement | DODIC | Time (Seconds) |
| Controlled Pair | AB57 (2) AB56 (3 to 5) | 3 | |
| TOWER | | SOLDIER ACTION | |
| WEAPONS SAFETY STATUS RED | FIRERS LOW READY | Soldier loads one 10-round magazine or 50-round belt, verify weapon is on SAFE, and establish the LOW READY position. | |
| ENGAGEMENT / MOVEMENT | CONTACT FRONT | | |
| CONTROL | READY | Soldier identifies the sector of fire visually while remaining at the LOW READY. | |
| EXECUTION | UP | The Soldier – A – Acquires target B – Begins Shot Process C – Confirms threat D – Delivers controlled pair E – Ends the engagement | |
| TOWER AWAITS ALL FIRERS TO COMPLETE THE ENGAGEMENT THEN CONTINUES | | | |
| CONTROL | WEAPONS HOLD WEAPONS HOLD | Soldiers return to RED STATUS, LOW READY | |
| MOVEMENT | MOVE TO THE 10-METER LINE, RIGHT TURN | Soldiers move to the 10-meter line, then face to the RIGHT. The weapon may not be oriented toward the target area, depending on the firer's dominant hand. | |
| WEAPONS SAFETY STATUS REMAINS RED | | | |
| Legend: DODIC – Department of Defense identification code, URM – urban rifle marksmanship | | | |

H-106. As soon as the tower operator confirms all firers have moved to the 10-meter firing line and are facing to the right, the tower operator continues. Table H-61 provides the commands for engagement 2.

Table H-61. Table VI, Engagement 2, 10-meter line, conduct of fire example

| <i>URM, Table VI, Engagement 2, 10-meter Line</i> | | | |
|--|----------------------------------|---|---------------------------------|
| | Engagement | Target | Target Type |
| | 2 | B-7 | Standing Silhouette Lethal Zone |
| | Rounds per Engagement | DODIC | Time (Seconds) |
| | Controlled Pair | AB57 (2) AB56 (3 to 5) | 3 |
| TOWER | | SOLDIER ACTION | |
| WEAPON SAFETY STATUS REMAINS RED | | | |
| ENGAGEMENT / MOVEMENT | CONTACT LEFT | Soldier's head turns LEFT. | |
| CONTROL | READY | Soldier identifies the target area while remaining at the LOW READY | |
| EXECUTION | UP | The Soldier turns to the LEFT, squaring shoulders to the threat, then – A – Acquires target B – Begins Shot Process C – Confirms threat D – Delivers controlled pair E – Ends the engagement | |
| TOWER AWAITS ALL FIRERS TO COMPLETE THE ENGAGEMENT | | | |
| CONTROL | WEAPONS HOLD WEAPONS HOLD | Soldiers return to RED STATUS, LOW READY | |
| MOVEMENT | LEFT TURN | Soldier sets to the LEFT, 90-degrees from the threat area. The weapon may not be oriented toward the target area, depending on the firer's dominant hand. | |
| WEAPONS SAFETY STATUS REMAINS RED | | | |
| Legend: DODIC – Department of Defense identification code, URM – urban rifle marksmanship | | | |

H-107. As soon as the tower operator confirms all firers have completed the engagement, the tower operator instructs the Soldiers to face to the left in preparation for the next engagement. Table H-62 provides the commands for engagement 3.

Table H-62. Table VI, engagement 3, 10-meter line, conduct of fire example

| <i>URM, Table VI, Engagement 3, 10-meter Line</i> | | | |
|--|--------------------------------------|--|---------------------------------|
| | Engagement | Target | Target Type |
| | 3 | B-7 | Standing Silhouette Lethal Zone |
| | Rounds per Engagement | DODIC | Time (Seconds) |
| | Controlled Pair | AB57 (2) AB56 (3 to 5) | 3 |
| TOWER | | SOLDIER ACTION | |
| WEAPON SAFETY STATUS REMAINS RED | | | |
| ENGAGEMENT / MOVEMENT | CONTACT RIGHT | Soldier's head turns RIGHT. | |
| CONTROL | READY | Soldier identifies the target area while remaining at the LOW READY | |
| EXECUTION | UP | The Soldier turns to the RIGHT, squaring shoulders to the threat, then – A – Acquires target B – Begins Shot Process C – Confirms threat D – Delivers controlled pair E – Ends the engagement | |
| TOWER AWAITS ALL FIRERS TO COMPLETE THE ENGAGEMENT | | | |
| CONTROL | WEAPONS HOLD WEAPONS HOLD | Soldiers return to RED STATUS, LOW READY | |
| MOVEMENT | FRONT | Soldier assumes a STANDING, UNSUPPORTED position with shoulders squared to the target area. | |
| WEAPONS SAFETY STATUS REMAINS RED | | | |
| Legend: DODIC – Department of Defense identification code, URM – urban rifle marksmanship | | | |

H-108. As soon as the tower operator confirms all firers have completed the engagement, the tower operator instructs the Soldiers to shift to the right target emplacement. Once all firers have shifted, the tower operator directs the firers to face to the left in preparation for the next engagement. Table H-63 provides the commands for engagement 4.

Table H-63. Table VI, engagement 4, 10-meter line, conduct of fire example

| <i>URM, Table VI, Engagement 4, 10-meter Line</i> | | | |
|--|--------------------------------------|---|---------------------------------|
| | Engagement | Target | Target Type |
| | 4 | B-7 | Standing Silhouette Lethal Zone |
| | Rounds per Engagement | DODIC | Time (Seconds) |
| | Controlled Pair | AB57 (2) AB56 (3 to 5) | 3 |
| TOWER | | SOLDIER ACTION | |
| WEAPON SAFETY STATUS REMAINS RED | | | |
| ENGAGEMENT / MOVEMENT | CONTACT RIGHT | Soldier begins moving FORWARD. | |
| ONCE OFFSET FROM THE TARGET, TOWER CONTINUES. | | | |
| CONTROL | READY | Soldier identifies the target area while remaining at the LOW READY | |
| EXECUTION | UP | The Soldier turns to the left, squaring shoulders to the threat, then – A – Acquires target B – Begins Shot Process C – Confirms threat D – Delivers controlled pair E – Ends the engagement | |
| TOWER AWAITS ALL FIRERS TO COMPLETE THE ENGAGEMENT | | | |
| CONTROL | WEAPONS HOLD WEAPONS HOLD | Soldiers return to RED STATUS, LOW READY | |
| MOVEMENT | FRONT | Soldier assumes a STANDING, UNSUPPORTED position with shoulders squared to the target area. | |
| WEAPONS SAFETY STATUS REMAINS RED | | | |
| Legend: DODIC – Department of Defense identification code, URM – urban rifle marksmanship | | | |

H-109. As soon as the tower operator confirms all firers have completed the engagement, the tower operator instructs the Soldiers to shift to the left target emplacement. Once all firers have shifted, the tower operator directs the firers to face to the right in preparation for the next engagement. Table H-64 provides the commands for the fifth engagement.

Table H-64. Table VI, engagement 5, 10-meter line, conduct of fire example

| <i>URM, Table VI, Engagement 5, 10-meter Line</i> | | | |
|--|--------------------------------------|---|---------------------------------|
| <p>The diagram illustrates the engagement setup. A soldier starts at a 'BASELINE' position. An arrow indicates movement to a '10 meters' line, then to a '5 meters' line. The soldier then moves to a 'START POSITION 90° RIGHT'. A target area is shown with a silhouette of a person, labeled 'B-7'.</p> | Engagement | Target | Target Type |
| | 5 | B-7 | Standing Silhouette Lethal Zone |
| | Rounds per Engagement | DODIC | Time (Seconds) |
| Controlled Pair | AB57 (2) AB56 (3 to 5) | 3 | |
| TOWER | SOLDIER ACTION | | |
| WEAPON SAFETY STATUS REMAINS RED | | | |
| ENGAGEMENT / MOVEMENT | CONTACT LEFT | Soldier begins moving FORWARD. | |
| ONCE OFFSET FROM THE TARGET, TOWER CONTINUES. | | | |
| CONTROL | READY | Soldier identifies the target area while remaining at the LOW READY | |
| EXECUTION | UP | The Soldier turns to the left, squaring shoulders to the threat, then – A – Acquires target B – Begins Shot Process C – Confirms threat D – Delivers controlled pair E – Ends the engagement | |
| TOWER AWAITS ALL FIRERS TO COMPLETE THE ENGAGEMENT FIRERS PERFORM EMERGENCY RELOAD (M4/M16) | | | |
| CONTROL | WEAPONS HOLD WEAPONS HOLD | Soldiers return to RED STATUS, LOW READY | |
| MOVEMENT | MOVE TO THE 25-METER LINE | Soldier moves to the 25-meter firing line and assumes a STANDING, UNSUPPORTED position, LOW READY. | |
| WEAPONS SAFETY STATUS REMAINS RED | | | |
| Legend: DODIC – Department of Defense identification code, URM – urban rifle marksmanship | | | |

H-110. The tower operator instructs the Soldiers to move to the 25-meter firing line in preparation for the next engagement. Table H-65 provides the commands for the sixth engagement.

Table H-65. Table VI, engagement 6, 25-meter line, conduct of fire example

| <i>URM, Table VI, Engagement 6, 25-meter Line</i> | | | |
|--|--------------------------------------|---|---------------------------------|
| | Engagement | Target | Target Type |
| | 6 | B-7 | Standing Silhouette Lethal Zone |
| | Rounds per Engagement | DODIC | Time (Seconds) |
| | Controlled Pair | AB57 (2) AB56 (3 to 5) | 3 |
| TOWER | | SOLDIER ACTION | |
| WEAPON SAFETY STATUS REMAINS RED | | | |
| ENGAGEMENT / MOVEMENT | CONTACT FRONT | | |
| CONTROL | READY | Soldier identifies the sector of fire visually while remaining at the LOW READY. | |
| EXECUTION | UP | The Soldier – A – Acquires target B – Begins Shot Process C – Confirms threat D – Delivers controlled pair E – Ends the engagement | |
| TOWER AWAITS ALL FIRERS TO COMPLETE THE ENGAGEMENT THEN CONTINUES | | | |
| CONTROL | WEAPONS HOLD WEAPONS HOLD | Soldiers return to RED STATUS, LOW READY | |
| MOVEMENT | FRONT | Soldiers maintain the LOW READY at the 25-meter firing line. | |
| WEAPONS SAFETY STATUS REMAINS RED | | | |
| Legend: DODIC – Department of Defense identification code, URM – urban rifle marksmanship | | | |

H-111. Once the tower operator confirms all firers have completed the engagement, the tower operator instructs the Soldiers to remain at the 25-meter firing line in preparation for the next engagement. Table H-66 provides the commands for the seventh engagement.

Table H-66. Table VI, engagement 7, 25-meter line, conduct of fire example

| <i>URM, Table VI, Engagement 7, 25 to 20-meter Line, Moving</i> | | | |
|---|--|---|---------------------------------|
| | Engagement | Target | Target Type |
| | 7 | B-7 | Standing Silhouette Lethal Zone |
| | Rounds per Engagement | DODIC | Time (Seconds) |
| Controlled Pair | AB57 (2) AB56 (3 to 5) | 3 | |
| TOWER | | SOLDIER ACTION | |
| WEAPON SAFETY STATUS REMAINS RED | | | |
| ENGAGEMENT / MOVEMENT | CONTACT FRONT | Soldier begins movement forward. | |
| CONTROL | MOVE OUT READY | Soldier identifies the target area while remaining at the LOW READY | |
| EXECUTION | UP | The Soldier squares shoulders to the threat, then – A – Acquires target B – Begins Shot Process C – Confirms threat D – Delivers controlled pair E – Ends the engagement | |
| TOWER AWAITS ALL FIRERS TO COMPLETE THE ENGAGEMENT FIRERS SHOULD BE AT THE 20-METER LINE | | | |
| CONTROL | WEAPONS HOLD WEAPONS HOLD | Soldiers return to RED STATUS, LOW READY | |
| MOVEMENT | ABOUT FACE | Soldier turns to the REAR, facing away from the target area. The weapon is not oriented toward the target area. | |
| WEAPONS SAFETY STATUS REMAINS RED | | | |
| Legend: DODIC – Department of Defense identification code, URM – urban rifle marksmanship | | | |

H-112. As soon as the tower operator confirms all firers have completed the engagement, the tower operator instructs the Soldiers to move to the 20-meter firing line and to face the rear (away from the target area) in preparation for the next engagement. Table H-67 provides the commands for engagement 8.

Table H-67. Table VI, engagement 8, 20-meter line, conduct of fire example

| <i>URM, Table VI, Engagement 8, 20 to 15-meter Line, Moving</i> | | | |
|---|--------------------------------------|---|---------------------------------|
| | Engagement | Target | Target Type |
| | 8 | B-7 | Standing Silhouette Lethal Zone |
| | Rounds per Engagement | DODIC | Time (Seconds) |
| | Controlled Pair | AB57 (2) AB56 (3 to 5) | 3 |
| TOWER | | SOLDIER ACTION | |
| WEAPON SAFETY STATUS REMAINS RED | | | |
| ENGAGEMENT / MOVEMENT | CONTACT REAR | Soldier turns head slightly over nondominant shoulder. Soldier turns toward the target and begins movement forward. | |
| CONTROL | MOVE OUT READY | Soldier identifies the target area while remaining at the LOW READY | |
| EXECUTION | UP | The Soldier squares shoulders to the threat, then – A – Acquires target B – Begins Shot Process C – Confirms threat D – Delivers controlled pair E – Ends the engagement | |
| TOWER AWAITS ALL FIRERS TO COMPLETE THE ENGAGEMENT FIRERS SHOULD BE AT THE 15-METER LINE | | | |
| CONTROL | WEAPONS HOLD WEAPONS HOLD | Soldiers return to RED STATUS, LOW READY | |
| MOVEMENT | ABOUT FACE | Soldier turns to the REAR, facing away from the target area. The weapon is not oriented toward the target area. | |
| WEAPONS SAFETY STATUS REMAINS RED | | | |
| Legend: DODIC – Department of Defense identification code, URM – urban rifle marksmanship | | | |

H-113. As soon as the tower operator confirms all firers have completed the engagement, the tower operator instructs the firers to move to the 15-meter firing line. The tower operator instructs the firers to face to the rear (away from the target area) in preparation for the next engagement. Table H-68 provides the commands for engagement 9.

Table H-68. Table VI, engagement 9, 15-meter line, conduct of fire example

| <i>URM, Table VI, Engagement 9, 15-meter Line, Threat to Rear</i> | | | |
|---|--------------------------------------|---|---------------------------------|
| | Engagement | Target | Target Type |
| | 9 | B-7 | Standing Silhouette Lethal Zone |
| | Rounds per Engagement | DODIC | Time (Seconds) |
| Controlled Pair | AB57 (2) AB56 (3 to 5) | 3 | |
| TOWER | | SOLDIER ACTION | |
| WEAPON SAFETY STATUS REMAINS RED | | | |
| ENGAGEMENT / MOVEMENT | CONTACT REAR | Soldier turns head slightly over nondominant shoulder. Soldier turns toward the target and begins movement forward. | |
| CONTROL | MOVE OUT READY | Soldier identifies the target area while remaining at the LOW READY | |
| EXECUTION | UP | The Soldier squares shoulders to the threat, then – A – Acquires target B – Begins Shot Process C – Confirms threat D – Delivers controlled pair E – Ends the engagement | |
| TOWER AWAITS ALL FIRERS TO COMPLETE THE ENGAGEMENT FIRERS SHOULD BE AT THE 15-METER LINE | | | |
| CONTROL | WEAPONS HOLD WEAPONS HOLD | Soldiers return to RED STATUS, LOW READY | |
| MOVEMENT | ABOUT FACE | Soldier turns to the REAR, facing away from the target area. The weapon is not oriented toward the target area. | |
| WEAPONS SAFETY STATUS REMAINS RED | | | |
| Legend: DODIC – Department of Defense identification code, URM – urban rifle marksmanship | | | |

H-114. Once the tower operator confirms all firers have completed the engagement, the tower operator instructs the Soldiers to remain at the 15-meter firing line and face to the rear (away from the target area) in preparation for the next engagement. Table H-69 provides the commands for engagement 10.

Table H-69. Table VI, engagement 10, 15-meter line, conduct of fire example

| <i>URM, Table VI, Engagement 10, 15- to 10-meter Line, Moving</i> | | | |
|--|--------------------------------|---|---------------------------------|
| | Engagement | Target | Target Type |
| | 10 | B-7 | Standing Silhouette Lethal Zone |
| | Rounds per Engagement | DODIC | Time (Seconds) |
| Controlled Pair | AB57 (2) AB56 (3 to 5) | 3 | |
| TOWER | | SOLDIER ACTION | |
| WEAPON SAFETY STATUS REMAINS RED | | | |
| ENGAGEMENT / MOVEMENT | CONTACT REAR | Soldier turns head slightly over nondominant shoulder. Soldier turns toward the target and begins movement forward. | |
| CONTROL | MOVE OUT READY | Soldier identifies the target area while remaining at the LOW READY | |
| EXECUTION | UP | The Soldier squares shoulders to the threat, then – A – Acquires target B – Begins Shot Process C – Confirms threat D – Delivers controlled pair E – Ends the engagement | |
| TOWER AWAITS ALL FIRERS TO COMPLETE THE ENGAGEMENT | | | |
| TERMINATION | CEASEFIRE CEASEFIRE | Soldiers return to RED STATUS, LOW READY | |
| WEAPONS SAFETY STATUS GREEN | GO GREEN GO GREEN | Soldier clears the weapon and awaits for the commands from the tower. | |
| Legend: DODIC – Department of Defense identification code, URM – urban rifle marksmanship | | | |

H-115. The lane safety clears the Soldiers upon completion of Table VI and recovering their targets. A lane safety verifies the clearing prior to the Soldier moving from the firing point. Once the Soldiers have cleared, the lane safety communicates the WSS to the tower operator and the tower operator issues an administrative command moving the Soldiers off the range. Table H-70 provides an example of these commands.

Table H-70. Table VI, Completed firing order, conduct of the range example

| Completed Firing Order, Conduct of the Range | | | |
|--|--|-----------------------|---|
| | Task | Target | Target Type |
| | Completed Firing Order | N/A | N/A |
| | Rounds per Target | DODIC | Time (Seconds) |
| | N/A | N/A | NO LIMIT |
| TOWER | | SOLDIER ACTION | |
| FIRERS ARE IN A GREEN STATUS | | | |
| ONCE ALL FIRERS ARE COMPLETE, THE TOWER CONTINUES | | | |
| CONDUCT OF THE RANGE | MOVE TO YOUR TARGET AND REVIEW YOUR SHOTS REPLACE ALL TARGETS | | |
| ONCE COMPLETE, THE TOWER CONTINUES | | | |
| CONDUCT OF THE RANGE | SECURE YOUR DUNNAGE AND TARGET ONCE COMPLETE MOVE TO THE BASELINE | | Firers secure weapon, ammunition dunnage, and target and move to the designated location. |
| FIRERS ARE IN A GREEN STATUS | | | |
| ONCE ALL FIRERS ARE AT THE BASELINE, TOWER CONTINUES. | | | |
| Legend: DODIC – Department of Defense identification code, N/A – not applicable | | | |

H-116. Lane safeties annotate the number of hits in the lethal zone, annotate any misses, subtract any shots fired after the three seconds have elapsed and remove the targets. Lane safeties install targets for the next firing order. Afterward, firers secure all dunnage between the firing points. As soon as the lane safety clears the completed firing order, the tower operator moves a new firing order into position and the process repeats itself until all firers have successfully completed Table VI training. The firing sequence for the night phase is the same as the firing sequence during the day.

Appendix I

Assisted Night Fire

This appendix describes the Army-standard events for training through certification of all Soldiers who have been assigned an M16, M4, or M249 automatic rifle with an aiming device. These devices, designed for use during periods of limited visibility, include pointers, illuminators, lasers, and thermal weapons sights. Once successfully completed, Soldiers can progress to higher levels of marksmanship training or certification. They may use the weapon and associated aiming device during any limited visibility, collective live-fire training events within the certification period.

Appendix I provides an overview of the assisted night fire certification standards. This appendix provides a snapshot to commanders of the Army’s requirement to achieve and sustain a level of weapons proficiency for their Soldiers who are assigned a rifle and carbine with a limited visibility-aiming device. Soldiers executing the assisted, night fire training strategy must also be qualified on their primary, assigned individual weapon and equipment within the past certification period based on the commander’s MAL.

ASSISTED NIGHT FIRE TRAINING STRATEGY

I-1. The standard IWTS lists six tables of training events. Each table’s events are explained with all associated resources required; ranges, simulators, simulations, ammunition, and time, as appropriate. This appendix has a section for each training event and stage within the weapon’s strategy. Companies executing the training events will apply the eight-step training model, as appropriate.

I-2. Table I-1 shows the assisted night fire training strategy through certification. The table provides the sequence of training events, the days required, and the training time remaining to achieve live-fire proficiency.

Table I-1. Individual weapons training strategy structure

| <i>Assisted Night Fire</i> | <i>Table I, PMI&E PRQ</i> | <i>Table II, PLFS PRQ</i> | <i>Table III, Drills PRQ</i> | <i>Table IV, Basic REQ</i> | <i>Table V, Practice</i> | <i>Table VI, CERT REQ</i> |
|---|-------------------------------|---------------------------|------------------------------|----------------------------|--------------------------|---------------------------|
| Days Required | 0.5 | 0.5 | 0.5 | 1.0 | 1.0 | 1.0 |
| Legend: CERT – certification, PLFS – preliminary live-fire simulation, PMI&E – preliminary marksmanship instruction and evaluation, PRQ – prerequisite, REQ – required | | | | | | |

I-3. The ammunition required for the assisted, night fire training strategy through certification is shown in table I-2 on page I-2. This list includes the associated weapons by LIN and NSN, all training munitions including DDI requirements, and the live-fire training ammunition requirements.

I-4. The numbers replicate the amount of ammunition each firer is authorized to complete one complete iteration of each event within the training strategy through certification. The munitions listed in table I-2 do not include any retraining, cross-training, demonstration munitions, or collective training requirements.

I-5. The ammunition required for the sniper rifle training strategy through qualification is shown in table I-2. This list includes the associated weapons by LIN and NSN, all training munitions including DDI requirements, and the live-fire training ammunition requirements.

I-6. The numbers replicate what each firer is authorized to complete one complete iteration of each event within the training strategy through qualification. The munitions listed below do not include any retraining, cross-training, demonstration munitions, or collective training requirements.

Table I-2. Assisted night fire training strategy ammunition requirements

| <i>M4 / M16</i> | | | | | |
|--|--|-----------------------|---------------------------|----------------------|--------------|
| <i>DODIC</i> | <i>Munition Type</i> | <i>Table IV Basic</i> | <i>Table V Practice</i> | <i>Table VI CERT</i> | <i>Total</i> |
| AB57 | CTG, 5.56mm, ball, M855A1 EPR | 45 | 50 | 50 | 145 |
| <i>M249AR</i> | | | | | |
| <i>DODIC</i> | <i>Munition Type</i> | <i>Table IV Basic</i> | <i>Table V Practice</i> | <i>Table VI CERT</i> | <i>Total</i> |
| AB57 | CTG, 5.56mm, ball, M855A1 EPR | 35 | 50 | 50 | 135 |
| AB73 | CTG, 5.56mm Linked (4:1) M855A1 (ball) & M856A1 (tracer) | | 200 | 200 | 400 |
| <i>Model</i> | <i>LIN / NSN</i> | <i>Model</i> | <i>LIN / NSN</i> | | |
| M4 | R97234 / 1005-01-231-0973 | M16A2 | R95035 / 1005-01-128-9936 | | |
| M4A1 | C06935 / 1005-01-382-0953 | M16A4 | R97175 / 1005-01-383-2872 | | |
| M249AR | M09009 / 1005-01-127-7510 | | | | |
| Legend: AR – automatic rifle, CERT – certification course of fire, CTG – cartridge, DODIC – Department of Defense identification code, EPR – enhanced performance round, LIN – line item number, mm – millimeter, NSN – national stock number | | | | | |

ASSISTED NIGHT FIRE, TABLE I, PRELIMINARY MARKSMANSHIP INSTRUCTION AND EVALUATION

I-7. The PMI&E event is a live-fire prerequisite that Soldiers must complete prior to executing any live-fire event that requires using limited visibility aiming devices. Assisted Night Fire, Table I, PMI&E consists of tasks that are critical to the safety of the firer, essential to the operation of the weapon assigned, or key to the effective employment of the weapon system. Leaders use Table I, PMI&E to test the Soldier’s ability to accomplish these critical tasks correctly, effectively, and efficiently. Leaders conduct all tasks in a garrison environment prior to the live-fire weapons training density.

TASK, CONDITIONS, AND STANDARD

I-8. Units are encouraged to conduct preparatory training prior to using Table I (for example, hip pocket training, STT) to maximize available resources. Units will develop a written test evaluating the functional aspects of the weapon, ammunition, and critical skills articulated in the appropriate TC. Soldiers must successfully complete the tasks listed in Assisted Night Fire, Table I, PMI&E, within the training window T-6 though T-week for both active Army and Reserves. (See table I-3.)

Note. Refer to TC 3-20.0 for more information on the training timelines for all live-fire prerequisites. See TC 3-22.9 or TC 3-22.249 for weapon specific and tactical employment information regarding assisted night fire.

I-9. At a minimum, units provide instruction and evaluation on the standard PMI&E topics described in TC 3-22.9 to Soldiers assigned an M4, M16, or TC 3-22.249 for Soldiers assigned M249 automatic rifle and a limited visibility-aiming device. Units may add topics to their Table I requirements, as necessary.

Table I-3. Assisted night fire, Table I, Preliminary Marksmanship Instruction and Evaluation

| | |
|--------------------|--|
| Task: | Demonstrate proficiency on the functional aspects of the weapon, ammunition, aiming device and critical skills necessary to correctly and safely employ the rifle and carbine in a limited visibility environment. |
| Conditions: | In a garrison environment, given a rifle and carbine as assigned on the master authorization list for the unit. Provided the correct reference to conduct training: <ul style="list-style-type: none"> • Training Circular (TC) 3-22.9. • TC 3-22.249. • Technical Manual (TM) 9-1005-319-10. • TM 9-1005-201-10. • Appropriate technical manual for the assigned aiming device. |
| Standard: | The Soldier must successfully pass PMI&E between T-6 and T-week prior to firing any live ammunition by receiving all GOs on demonstrated performance and achieving a passing score of 80 percent or higher on a written test. |

I-10. Table I-4, on page I-4, shows the training event design template for Assisted Night Fire, Table I, PMI&E. Units use the training event design templates to assist in the proper synchronization when developing their UTP.

Table I-4. Training event design template for assisted night fire, Table I

| <i>Assisted Night Fire, Table I, PMI&E</i> | | | | | | |
|--|--------------------------|---------------------|----------------------|---------------------------------|-----------------------|---------------------------|
| EVENT NAME: | PMI&E | | ENVIRONMENT: | | LIVE | 0.5 |
| WEAPON: | M4 / M16 / M249AR | | CONDITIONS: | | HANDS ON | |
| CATEGORY: | CERTIFICATION | | PRIMARY FACILITY: | | GARRISON | DAYS REQUIRED |
| PUBLICATION: | TC 3-22.9 TC 3-22.249 | | ALTERNATE FACILITY: | | CLASS | |
| REQUIRED: | YES | | COMPONENT: | AC | RC | 120 SOLDIERS |
| EXTERNAL EVAL: | OPTIONAL | | FREQUENCY: | 2 | 1 | |
| VALID FOR: | T+6 | | ANNUAL DAYS TOTAL: | 1 | 0.5 | THROUGHPUT |
| | TABLE | | | | | |
| | I | II | III | IV | V | VI |
| | PMI&E | PLFS | DRILLS | BASIC | PRACTICE | CERT |
| | REQUIRED | | | | | 4.0 |
| WHEN EXECUTED: | T-6 through T-X | | | | | TNG DAYS TO CERT |
| CONDEMNATION CRITERIA (CC) | RULE 1 | RULE 2 | RULE 3 | RULE 4 | RULE 5 | RULE 6 |
| | TIME | KEY LEADER TURNOVER | COMMANDER ASSESSMENT | SUBORDINATE ELEMENT PROFICIENCY | SPECIALTY PROFICIENCY | STAFF SECTION PROFICIENCY |
| Remarks: Each Soldier assigned an individual weapon must successfully complete Table I, PMI&E, between T-6 and T-X, <i>prior to any live-fire event with the weapon.</i> | | | | | | |
| Note: Table I <i>should</i> be completed prior to any other table to ensure the Soldier understands the proper functioning and immediate action for the weapon. | | | | | | |
| Legend: AC – active component (known as active duty), AR – automatic rifle, CERT – certification, CLASS - classroom, EVAL – evaluation, PLFS – preliminary live-fire simulation, PMI&E – preliminary marksmanship instruction and evaluation, RC – Reserve Component (known as Reserves), TC – training circular, T+6 – training week or month plus six, T-X – training event exercise, TNG DAYS TO CERT – number of training days remaining on the critical path to weapon’s certification | | | | | | |

TRAINING PLAN

I-11. Table I-5 and Table I-6 on page I-6 show the Assisted Night Fire, Table I, PMI&E training plan's tasks the Soldier demonstrates proficiency on to receive credit. Leaders and trainers must be proficient on these tasks prior to conducting training and testing.

Table I-5. Assisted night fire, Table I, Preliminary Marksmanship Instruction and Evaluation training plan for M4 / M16 firers

| <i>Reference</i> | <i>Topic or Task</i> |
|--|--|
| TC 3-22.9 | Rules of fire arms safety |
| TC 3-22.9 | Weapons safety status |
| TC 3-22.9 | Weapons control status |
| TC 3-20.31-4 | Conduct of fire (fire commands) |
| TC 3-22.9 | Magazine change, rifle and carbine, emergency |
| TC 3-22.9 | Magazine change, rifle and carbine, tactical |
| TC 3-22.9 | Preliminary marksmanship instruction and evaluation (PMI&E), rifle and carbine |
| 071-008-0015 | Mount an AN/PAS-13 thermal weapon sight on an M16-series rifle / M4-series carbine |
| 071-008-0014 | Dismount an AN/PAS-13 thermal weapon sight from an M16 series rifle / M4 series Carbine |
| 071-100-0022 | Zero an AN/PAS-13 thermal weapon sight to an M16-series rifle or M4-series carbine |
| 071-100-0039 | Mount an AN/PAQ-4 series aiming light on an M16-series rifle / M4-series carbine |
| 071-100-0043 | Boresight an AN/PAQ-4 to an M16-series rifle / M4-series carbine |
| 071-100-0047 | Zero an AN/PAQ-4-series aiming light to an M16-series rifle / M4-series carbine |
| 071-100-0040 | Dismount an AN/PAQ-4 series aiming light on an M16-series rifle / M4-series carbine |
| 071-702-0004 | Mount an AN/PEQ-2 series target pointer illuminator / aiming light on an M16-series rifle / M4-series carbine |
| 071-702-0003 | Boresight an AN/PEQ-2 series aiming light to an M16-series rifle / M4-series carbine |
| 071-702-0007 | Zero an AN/PEQ-2 series target pointer illuminator / aiming light to an M16-series rifle / M4-series carbine |
| 071-702-0005 | Dismount an AN/PEQ-2 series target pointer illuminator / aiming light to on a M16-series rifle / M4-series carbine |
| Note: ALL Soldiers participating in assisted night fire will conduct PMI&E. | |
| Legend: COM – common, TC – training circular | |

Table I-6. Assisted night fire, Table I, Preliminary Marksmanship Instruction and Evaluation training plan for M24AR firers

| Reference | Topic or Task |
|--|---|
| TC 3-22.249 | Rules of fire arms safety |
| TC 3-22.249 | Weapons safety status |
| TC 3-22.249 | Weapons control status |
| TC 3-20.31-4 | Conduct of fire (fire commands) |
| 071-010-0016 | Mount an AN/PEQ-2 aiming light to an M249 squad automatic weapon |
| 071-010-0020 | Boresight an aiming light (AN/PEQ-2 OR AN/PEQ-15) to an M249 squad automatic weapon (SAW) |
| 071-010-0018 | Zero an AN/PEQ-2 aiming light to an M249 squad automatic weapon |
| 071-010-0017 | Dismount an AN/PEQ-2 aiming light to an M249 squad automatic weapon |
| 071-010-0021 | Mount an AN/PEQ-15 aiming light to an M249 squad automatic weapon |
| 071-010-0023 | Zero an AN/PEQ-15 aiming light to an M249 squad automatic weapon |
| 071-010-0022 | Dismount an AN/PEQ-15 aiming light to an M249 squad automatic weapon |
| 071-010-0012 | Mount an AN/PAQ-4 infrared aiming light on an M249 machine gun |
| 071-100-0044 | Boresight an AN/PAQ-4 to an M249 machine gun |
| 071-010-0014 | Zero an AN/PAQ-4 infrared aiming light to an M249 machine gun |
| 071-010-0013 | Dismount an AN/PAQ-4 infrared aiming light from an M249 machine gun |
| 071-010-0008 | Mount an AN/PAS-13 thermal weapon sight on an M249 machine gun |
| 071-010-0010 | Zero an AN/PAS-13 thermal weapon sight to an M249 machine gun |
| 071-010-0009 | Dismount an AN/PAS-13 thermal weapon sight from an M249 machine gun |
| Note: ALL Soldiers participating in assisted night fire will conduct PMI&E. | |
| Legend: COM – common, TC – training circular | |

ASSISTED NIGHT FIRE, TABLE II, PRELIMINARY LIVE-FIRE SIMULATIONS

I-12. Leaders use Table II, PLFS to evaluate the Soldier's ability to engage single and multiple stationary targets from multiple stationary supported and unsupported firing positions, during limited visibility and CBRN conditions in a simulated combat environment. Soldiers are required to complete the simulations training plan prior to executing the Table II simulated certification course of fire. Table II (see table I-7) is a live-fire prerequisite that Soldier's must complete prior to any event using live ammunition (Tables IV, V, and VI, for example).

TASK, CONDITIONS, AND STANDARD

I-13. Units must use the approved primary or alternate simulations to execute the tasks in Table II for training records between T 6 and T-week for the upcoming weapons training density. Units must maintain the training records for Soldiers for a period of 12 months. When conducting live-fire events, units must have the Soldier's Table II training records readily available on the range facility.

Table I-7. Assisted night fire, Table II, Preliminary Live-Fire Simulations

| | |
|--------------------|---|
| Task: | Demonstrate proficiency on the functional aspects of the weapon, ammunition, and critical skills necessary to correctly use the M16, M4, or M249 with associated limited visibility aiming device. |
| Conditions: | Given the following: <ul style="list-style-type: none"> Fully mission capable weapon and equipment as assigned on the master authorization list for the unit. Full combat uniform, issued equipment, and protective mask (if assigned). An authorized simulations device with standard training model and Assisted Night Fire, Table II, Gate to Live Fire (GTLF) event. |
| Standard: | Demonstrate proficiency on select assisted night fire tasks and successfully complete the GTLF event between T-6 and T-week prior to firing any live ammunition. |

I-14. Table I-8, on page I-8, shows the general training information for planning purposes for the Assisted Night Fire, Table II. The training event design template provides key training information to develop the UTP for their Soldiers.

Table I-8. Training event design template for assisted night fire, Table II, Preliminary-Live-Fire Simulations

| <i>Assisted Night Fire, Table II, PLFS</i> | | | | | | |
|--|--------------------------|---------------------|----------------------|---------------------------------|-----------------------|---------------------------|
| EVENT NAME: | PLFS | ENVIRONMENT: | | VIRTUAL | 0.5 | |
| WEAPON: | M4 / M16 / M249AR | CONDITIONS: | | TADSS | | |
| CATEGORY: | CERTIFICATION | PRIMARY FACILITY: | | S/SVT | DAYS REQUIRED | |
| PUBLICATION: | TC 3-22.9 TC 3-22.249 | ALTERNATE FACILITY: | | DRY | | |
| REQUIRED: | YES | COMPONENT: | AC | RC | 120 SOLDIERS | |
| EXTERNAL EVAL: | OPTIONAL | FREQUENCY: | 2 | 1 | | |
| VALID FOR: | T+6 | ANNUAL DAYS TOTAL: | 1 | 0.5 | THROUGHPUT | |
| TABLE | | | | | | |
| | I | II | III | IV | V | VI |
| | PMI&E | PLFS | DRILLS | BASIC | PRACTICE | CERT |
| | | REQUIRED | | | | 3.5 |
| WHEN EXECUTED: | T-6 through T-X | | | | | TNG DAYS TO CERT |
| CONDEMNATION CRITERIA (CC) | RULE 1 | RULE 2 | RULE 3 | RULE 4 | RULE 5 | RULE 6 |
| | TIME | KEY LEADER TURNOVER | COMMANDER ASSESSMENT | SUBORDINATE ELEMENT PROFICIENCY | SPECIALTY PROFICIENCY | STAFF SECTION PROFICIENCY |
| <p>Remarks: Each Soldier assigned a limited visibility aiming device must successfully complete Table II, PLFS, between T-6 and T-X, prior to any live-fire event with the weapon and aiming device.</p> <p>Legend: AC – active component (known as active duty), AR – automatic rifle, CERT – certification, DRY – dry fire, EVAL – evaluation, PLFS – preliminary live-fire simulation, PMI&E – preliminary marksmanship instruction and evaluation, RC – Reserve Component (known as Reserves), S/SVT – soldier and squad virtual trainer, TADSS – training aids, devices, simulators, and simulations, TC – training circular, T+6 – training week or month plus six, TNG DAYS TO CERT – number of training days remaining on the critical path to weapon’s certification, T-X – training event exercise</p> | | | | | | |

SIMULATIONS

I-15. Each Soldier is authorized simulations usage for weapons training and sustainment based on their component. The authorized hours of training are cumulative annually so Soldiers can complete all required training prior to the execution of Table II training. Table I-9 shows the annual hours authorized per Soldier by component:

Table I-9. Simulations authorizations table

| <i>Simulation Time Authorizations (hours)</i> | |
|---|-----------------|
| <i>Active Army</i> | <i>Reserves</i> |
| 12.0 | 6.0 |

I-16. Table I-10 lists the primary and alternate simulations systems. Primary systems are the preferred method to deliver the appropriate training program to the Soldier. Alternate systems provide the minimum form, fit, and function capabilities to build the firer's skill and experience on basic tasks. The unit determines how to use the simulations hours authorized per Soldier within the fiscal year.

Table I-10. Assisted night fire, Table II, primary and alternate authorized systems

| System | Primary | Alternate | Remarks |
|---|----------------|------------------|--|
| Soldier and squad virtual trainer (S / SVT) | X | | |
| Dry-fire engagement drills | | X | Serves as a primary training device until S / SVT suite availability and accessibility are established Army-wide. Commanders should review dry-fire drill tasks and effectiveness prior to execution. |

Notes. For any other device or system not listed, the unit should contact the Maneuver Center of Excellence for possible system evaluation or if an approved training plan is available. Units are not authorized to develop training plans on unauthorized systems when authorized systems are available for training.

Individual weapons virtual simulation systems can effectively support no more than five firers per suite at a time. The standard simulations bay is composed of two suites, allowing for ten firers to train in a firing order. The unit develops a rotational plan to accommodate the total number of Soldiers training.

TRAINING PLAN

I-17. Soldiers train on their weapon according to the training plan for the simulation system. For simulation systems without an integrated training plan, operators must select the appropriate scenarios based on the system's IUH.

I-18. The simulations assisted night fire training plan culminates in the system's GTLF. Units may elect to train additional advanced tactical engagement scenarios, but must conduct grouping practice, CBRN, and the GTLF exercises at a minimum, as listed in table I-11, on page I-10.

Table I-11. Assisted night fire simulations training plan

| <i>Task</i> | <i>Simulations Exercise Name</i> | <i>Required GTLF</i> |
|---|---|----------------------|
| 1 | Auto zero (system maintenance function) | REQ |
| 2 | Grouping | REQ |
| 3 | Zeroing | REQ |
| 3 | Table V, Practice, Stage 1 | REQ |
| 4 | Table V, Practice, Stage 2 | REQ |
| 5 | Table VI, Certification, Stage 1 | GTLF |
| 6 | Table VI, Certification, Stage 2 | |
| 7 | Target discrimination | OPT |
| 8 | Magazine / belt change multiple-target | OPT |
| 9 | Multiple directional moving target | OPT |
| 10 | Transition from primary to secondary weapon | OPT |
| Legend: GTLF – gate to live fire, OPT – optional, REQ – required | | |

ASSISTED NIGHT FIRE, TABLE III, DRILLS

I-19. Table III, Drills is a series of physical actions (drills) that a Soldier completes with their assigned weapon and equipment in a repetitious manner to demonstrate proficiency in weapons handling and movement. Soldiers must successfully complete the drills in Table III prior to any live-fire event, including grouping procedures.

TASK, CONDITIONS, AND STANDARD

I-20. Typically, Soldiers conduct Table III training in a round-robin manner where the primary trainer is the team leader, squad leader, or assigned NCO. Table I-12 shows Table III’s task, conditions, and standards.

Table I-12. Assisted night fire, Table III, Drills, task, conditions, and standard

| | |
|--------------------|---|
| Task: | Demonstrate proficiency on the functional aspects of the weapon, ammunition, aiming device, and critical skills necessary to correctly use the M16, M4, or M249 automatic rifle with associated assigned equipment in a limited visibility environment. |
| Conditions: | <p>Given the following:</p> <ul style="list-style-type: none"> • Fully mission capable, weapon and equipment as assigned on the master authorization list for the unit. • Checklist of required actions and time standards found in Training Circular (TC) 3-22.9, TC 3-22.249 and associated individual task report described in this section. |
| Standard: | The Soldier successfully demonstrates proficiency by passing weapons handling, manipulation, and movement tasks listed in the training plan between T-6 and T-week prior to firing any live ammunition. |

I-21. Table I-13, on page I-12, shows the general training information for planning purposes for Assisted Night Fire, Table III. The training event design template provides key training information to develop the unit-training plan for their Soldiers.

Table I-13. Training event design template for assisted night fire, Table III, Drills

| <i>Assisted Night Fire, Table III, Drills</i> | | | | | | |
|--|--------------------------|---------------------|----------------------|---------------------------------|-----------------------|---------------------------|
| EVENT NAME: | DRILLS | | ENVIRONMENT: | | LIVE | 0.5 |
| WEAPON: | M4 / M16 / M249AR | | CONDITIONS: | | HANDS ON | |
| CATEGORY: | CERTIFICATION | | PRIMARY FACILITY: | | GARRISON | DAYS REQUIRED |
| PUBLICATION: | TC 3-22.9 TC 3-22.249 | | ALTERNATE FACILITY: | | TA | |
| REQUIRED: | YES | | COMPONENT: | AC | RC | 120 SOLDIERS |
| EXTERNAL EVAL: | FIRST LINE LEADER | | FREQUENCY: | 2 | 1 | |
| VALID FOR: | T+6 | | ANNUAL DAYS TOTAL: | 1 | 0.5 | THROUGHPUT |
| | TABLE | | | | | |
| | I | II | III | IV | V | VI |
| | PMI&E | PLFS | DRILLS | BASIC | PRACTICE | CERT |
| | | | REQUIRED | | | 3.0 |
| WHEN EXECUTED: | T-6 through T-X or T-X | | | | | TNG DAYS TO CERT |
| CONDEMNATION CRITERIA (CC) | RULE 1 | RULE 2 | RULE 3 | RULE 4 | RULE 5 | RULE 6 |
| | TIME | KEY LEADER TURNOVER | COMMANDER ASSESSMENT | SUBORDINATE ELEMENT PROFICIENCY | SPECIALTY PROFICIENCY | STAFF SECTION PROFICIENCY |
| <p>Remarks: Each Soldier assigned an individual weapon must successfully complete Table III, between T-6 and T-X, <i>prior to any live-fire event with the weapon utilizing the limited visibility aiming device</i>. Table III should be used as concurrent training on Tables IV, V, and VI while Soldiers are awaiting training within a firing order or between day and night phases.</p> | | | | | | |
| <p>Legend: AC – active component (known as active duty), CERT – certification, EVAL – evaluation, PLFS – preliminary live-fire simulation, PMI&E – preliminary marksmanship instruction and evaluation, RC – Reserve Component (known as Reserves), T+6 – training week or month plus six, TA – training area, TC – training circular, TNG DAYS TO CERT – number of training days remaining on the critical path to weapon’s certification, T-X – training event exercise</p> | | | | | | |

TRAINING PLAN

I-22. Table I-14 lists the individual tasks for each of these drills. The individual task reports for these drills are in a shared folder on AKO. The hyperlink to this folder is in the reference section at the back of this publication.

Table I-14. Assisted night fire, Table III, Drills individual training plan

| Task | Task Name |
|--|--|
| 1 | Precombat checks |
| 2 | Load and conduct status check |
| 3 | Carry positions |
| 4 | Fight down |
| 5 | Fight up |
| 6 | Go to prone |
| 7* | Transition from primary weapon to secondary weapon |
| 8 | Reload |
| 9** | Barrel change |
| 9 | Clear malfunction |
| 10 | Unload / show clear |
| <p>Note. Where the individual task reports are not available on the Army Training Network, the individual task reports for these drills is in a shared folder on Army Knowledge Online. The hyperlink to this folder is in the reference section at the back of this publication.</p> <p>* This drill is only for Soldiers assigned multiple individual weapons or Soldiers assigned an individual weapon with a special purpose weapon.</p> <p>** This drill is only for Soldiers assigned a M249 automatic rifle.</p> | |

I-23. Units may add to the drills listed in table I-14, but may not remove any drills from Table III. Units developing additional drills are encouraged to provide the details of the drill, evaluation process, and timing considerations to the proponent of this publication (listed in the preface) for possible inclusion into future revisions.

ASSISTED NIGHT FIRE, TABLE IV, BASIC

I-24. Units conduct the training in Assisted Night Fire, Table IV, Basic with live ammunition on an approved range facility. All firers evaluate their ability to place shot groups consistently within a designated bullseye target at 25 meters using the information in Table IV. Units conduct the information in this table only after successful completion of the live-fire prerequisite tables (Tables I, II, and III). During home station training, Soldiers must complete the training in Table IV prior to progressing to any other training event. Units conduct Table IV on an ARF or other approved facility.

TASK, CONDITIONS, AND STANDARD

I-25. Firers conduct Table IV tasks from the prone supported firing position 25 meters from the targets outlined in this chapter. Table IV training reinforces and builds upon skills learned in the previous training events. Table I-15, on page I-14, provides the task, conditions, and standards for Table IV.

Table I-15. Assisted night fire, Table IV, Basic

| | |
|---|--|
| Task: | Conduct grouping, zeroing, confirmation of zero at distance, and application of hold-offs with the M4, M16, or M249 automatic rifle with the limited visibility aiming device. |
| Conditions: | <p>Given the following:</p> <ul style="list-style-type: none"> • Fully mission capable weapon, magazine pouches, and magazines. • Authorized range facility, full-caliber ammunition, and approved targetry. • Unit selected method of zeroing (as described in Training Circular (TC) 3-22.9 or TC 3-22.249). |
| Standard: | <p>Grouping – Successfully group by placing four of five rounds in two consecutive five-round shot groups within a 6 MOA circle (threshold) or 4 MOA (objective) at 25-meters.</p> <p>Zeroing – Successfully place four of five rounds in two consecutive shot groups within the 6 MOA circle (threshold) or 4 MOA (objective) surrounding the appropriate point of impact on the A-8 zero target at 25-meters.</p> <p>Confirmation at Distance – after completion of the 25-meter zero, the Soldier must successfully hit a properly presented E-type target with a minimum of four of five (80-percent) shots.</p> <p>Application of Hold-Offs – After completion of confirmation at distance stage the Soldier must successfully hit a properly presented 100 meter E-type target with a minimum of four of five (80-percent) shots then the Soldier must also successfully hit a properly presented 200 meter E-type target with a minimum of four of five (80-percent) shots.</p> |
| Legend: m – meter, MOA – minute of angle | |

I-26. Table I-16 shows the training event design template for the Table IV, Basic. Units conduct this event on an authorized live-fire facility, typically an ARF range. See TC 25-8 for additional information on authorized range facilities.

Table I-16. Training event design template for assisted night fire, Table IV, Basic

| <i>Assisted Night Fire, Table IV, Basic</i> | | | | | | |
|---|--------------------------|---------------------------|-------------------------|---------------------------------------|--------------------------|---------------------------------|
| EVENT NAME: | BASIC | | ENVIRONMENT: | LIVE | | 1.0 |
| WEAPON: | M4 / M16 / M249AR | | CONDITIONS: | LIVE FIRE | | |
| CATEGORY: | CERTIFICATION | | PRIMARY FACILITY: | ARF | | DAYS REQUIRED |
| PUBLICATION: | TC 3-22.9 TC 3-22.249 | | ALTERNATE FACILITY: | MRF | | |
| REQUIRED: | YES | | COMPONENT: | AC | RC | 120 SOLDIERS |
| EXTERNAL EVAL: | COACH | | FREQUENCY: | 2 | 1 | |
| VALID FOR: | T-X | | ANNUAL DAYS TOTAL: | 2 | 1 | THROUGHPUT |
| | TABLE | | | | | |
| | I | II | III | IV | V | VI |
| | PMI&E | PLFS | DRILLS | BASIC | PRACTICE | CERT |
| | PRQ | PRQ | PRQ | REQUIRED | | 2.0 |
| WHEN EXECUTED: | | | | T-X | | TNG DAYS TO CERT |
| CONDEMNATION CRITERIA (CC) | RULE 1 | RULE 2 | RULE 3 | RULE 4 | RULE 5 | RULE 6 |
| | TIME | KEY LEADER TURNOVER | COMMANDER ASSESSMENT | SUBORDINATE ELEMENT PROFICIENCY | SPECIALTY PROFICIENCY | STAFF SECTION PROFICIENCY |
| Remarks: Each Soldier assigned an individual weapon equipped with a limited visibility aiming device must successfully complete Table IV, Basic. | | | | | | |
| Legend: AC – active component (known as Active Duty), ARF – automated record fire range, CERT – certification, EVAL - evaluation, MRF – modified record fire range or similar, PLFS – preliminary live-fire simulation, PMI&E – preliminary marksmanship instruction and evaluation, PRQ – prerequisite, RC – Reserve Component (known as Reserves), TC – training circular, TNG – training, TNG DAYS TO CERT – number of training days remaining on the critical path to weapon's certification, T-X – training event exercise, | | | | | | |

AMMUNITION

I-27. All Soldiers assigned a limited visibility aiming device on a unit MAL, must complete all four stages of Assisted Night Fire, Table IV prior to advancing to Table V or Table VI. Soldiers conduct the training in Table IV to demonstrate their ability to place well-aimed shots consistently at the intended point of impact of a target.

I-28. Firers conduct Table IV based on their limited visibility aiming device. Firers who are assigned multiple, limited visibility aiming devices must complete Table IV for each assigned device.

I-29. To effectively plan and forecast for sufficient training ammunition, the unit should refer to the ammunition requirements listed in table I-17 on page I-16. Units identify the total number of firers and should plan for unscheduled firers and necessary retraining by increasing their forecasted training ammunition appropriately.

Table I-17. Table IV, Basic, ammunition authorizations

| <i>Stage</i> | <i>DODIC</i> | <i>Nomenclature</i> | <i>Quantity</i> | <i>Remarks</i> |
|--|--------------|-----------------------------|-----------------|--|
| Stage 1, Grouping | AB57 | CTG 5.56mm ball, M855A1 EPR | 15 | Three each, five-round shot groups. |
| Stage 2, Zeroing | AB57 | CTG 5.56mm ball, M855A1 EPR | 15 | Three each, five-round shot groups after grouping exercise complete. |
| Stage 3, Confirmation at Distance | AB57 | CTG 5.56mm ball, M855A1 EPR | 5 | One each, five-round shot group. |
| Stage 4, Application of Hold-Offs | AB57 | CTG 5.56mm ball, M855A1 EPR | 10 | One each, five-round shot group at 100 meter target and one each, five-round shot group at 200 meter target. |
| Legend: CTG – cartridge, DODIC – Department of Defense identification code, EPR – enhanced performance round, mm – millimeter | | | | |

I-30. The ammunition NCO with a supporting detail (ammunition detail) loads the magazines with training ammunition as shown in table I-18. The ammunition NCO issues 5 magazines containing one round in each and 40 additional rounds to Soldiers firing the M249 automatic rifle. Soldiers must reload the 40 additional rounds into the five magazines for subsequent groups. Using single round magazines enables the M249 automatic rifle firer to fire well-aimed single shots using an automatic weapon system.

Table I-18. Assisted night fire, Table IV, ammunition breakdown per firer

| <i>Exercise</i> | <i>AB57 5.56mm Ball</i> | <i>Total Rounds per Magazine</i> | |
|--|---------------------------------|----------------------------------|------------------------|
| | | <i>M4 / M16</i> | <i>M249AR</i> |
| Stage 1, Grouping | 5 each | 5 rounds | 1 round x 5 magazines |
| Stage 1, Grouping | 5 each | 5 rounds | 1 round x 5 magazines |
| Stage 1, Grouping | 5 each | 5 rounds | 1 round x 5 magazines |
| Stage 2, Zero | 5 each | 5 rounds | 1 round x 5 magazines |
| Stage 2, Zero | 5 each | 5 rounds | 1 round x 5 magazines |
| Stage 2, Zero | 5 each | 5 rounds | 1 round x 5 magazines |
| Stage 3, Confirmation | 5 each | 5 rounds | 1 round x 5 magazines |
| Stage 4, Application of Hold-Offs | 10 each | 10 rounds | 1 round x 10 magazines |
| Total: | 45 rounds | 45 rounds | 45 rounds |
| <p>Note: When zero confirmation cannot be fired on the scheduled range facility, units should include that task with associated ammunition in their Table V, Practice event. The task is integrated into the Table V scenario, prior to the first Table V engagement.</p> <p>M249AR firers will load individual rounds into 5 separate magazines for each iteration of grouping, zeroing, confirmation at distance, and application of hold-offs. Loading single rounds facilitates the process by enabling the firer to fire single shots with an automatic weapon system.</p> | | | |
| Legend: M249AR – automatic rifle, mm – millimeter | | | |

RANGE FACILITIES

I-31. Table I-19 shows the Army-standard range facilities specifically designed to support Assisted Night Fire, Table IV, Basic (Grouping). Units reference their installation’s range operations SOPs or local training regulations to identify the weapon-specific range facilities on the supporting installation. Units use their RFMSS system for all scheduling.

Table I-19. Assisted night fire Table IV, Basic authorized range facilities and targetry

| <i>Table IV Stages</i> | <i>Range Facility</i> | | | |
|---|-----------------------|------------|------------|-------------|
| | <i>ARF</i> | <i>MRF</i> | <i>QTR</i> | <i>Zero</i> |
| Stage 1 Grouping 25 meters | P | P | P | A |
| Stage 2 Zeroing 25 meters | | | | |
| Stage 3 Confirmation at Distance | P | P | P | N/A |
| Stage 4 Application of Hold-Offs | | | | |
| Legend: A – alternate facility, ARF – automated record fire range, MRF – modified record fire range or similar, N/A – not applicable, P – primary facility, QTR – automated qualification training range, Zero – basic 10 meter / 25 meter firing range (zero) | | | | |

TARGETRY

I-32. Table IV, Grouping and Zeroing requires a minimum of three targets per firer, placed on a target frame as shown on figure I-1. The targets are placed on a frame with backer board at the 25-meter line. This is a static target presentation and does not use the automated targets on the primary range facility (ARF). During the preparation phase, leaders should be familiar with the targetry used, the target frames and their proper emplacement, and the firing sequence of the engagements. Figure I-2, on page I-20, shows the primary targets and their proper positioning on the primary range facility.



| Table IV Exercise | Targetry | |
|--|---|---|
| Stage 1, Grouping 25 meters | A8, target zero M4- / M16-series weapons 25-meter zero. Short range and pistol marksmanship target. |  |
| Stage 2, Zeroing 25 meters | | |
| Stage 3, Confirmation at Distance and Stage 4, Application of Hold-offs | E-1, target, silhouette: plastic, polyethylene, kneeling NSN 6920-00-071-4780 |  |
| | D-1, target, 3-dimensional: plastic, mannequin, kneeling NSN 6920-01-164-9625 |  |
| Legend: NSN – national stock number | | |

Figure I-1. Assisted Night Fire, Table IV, target requirements example

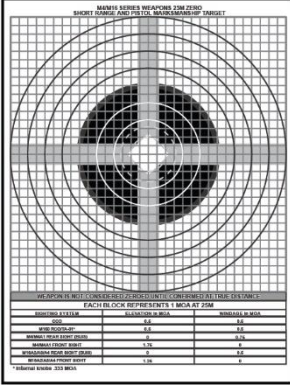
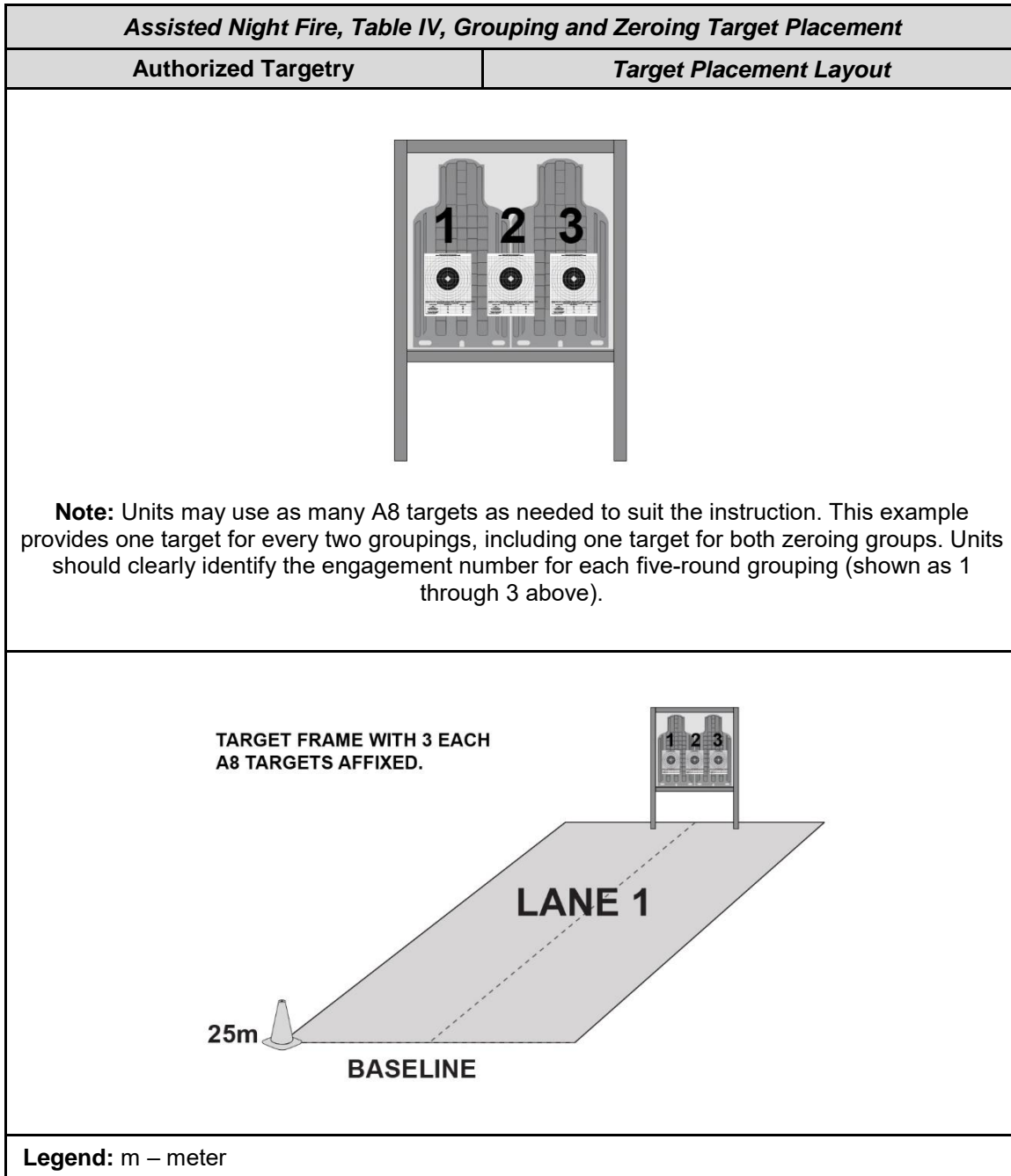

Figure I-2. Assisted Night Fire, Table IV, target placement requirements example

CONDUCT OF THE RANGE

I-33. Leaders instruct Soldiers on the objectives of grouping and the importance of the functional elements of the shot process (see TC 3-22.9 and TC 3-22.249). Units conduct the sequence in Table IV using eight separate engagements at targets 25-meters from the static firing point, with a zero confirmation target at distance (300 meter standard) and application of hold-offs at the 100-meter and 200-meter targets. Firers use one A8 target for two groupings. Soldiers complete the engagements in the sequence shown in table I-20.

Table I-20. Assisted night fire, Table IV, firing sequence example

| <i>Sequence</i> | <i>AB57 5.56mm Ball</i> | <i>Target Frame</i> | <i>Target Type</i> |
|--|---------------------------------|---------------------|--------------------|
| Group 1 | 5 each | 1 | A8 |
| Group 2 | 5 each | 1 | A8 |
| Group 3 | 5 each | 2 | A8 |
| Zero 1 | 5 each | 2 | A8 |
| Zero 2 | 5 each | 3 | A8 |
| Zero 3 | 5 each | 3 | A8 |
| Confirm at Distance | 5 each | 300m | E-type |
| Application of Hold-Offs | 10 each | 100m and 200m | E-type |
| Note: M249 firers must reload five each single round magazines in between groups. | | | |
| Legend: m – meter, mm – millimeter | | | |

I-34. To successfully complete Table IV tasks, firers must meet the unit directed standard (threshold or objective) for their aiming device. Table I-21 provides each threshold and objective standard for a shot group, grouping exercise, and zeroing.

Table I-21. Table IV, new firing order, conduct of the range example

| <i>Type</i> | <i>Standard</i> | | <i>Requirement</i> |
|--|------------------|------------------|--|
| | <i>Threshold</i> | <i>Objective</i> | |
| Shot Group | 6 MOA | 4 MOA | Four of five rounds |
| Grouping | 6 MOA | 4 MOA | Two consecutive standard shot groups |
| Begin Zeroing | | | Grouping standard met |
| Zero | 6 MOA | 4 MOA | Standard shot group centered at the POA. |
| Legend: MOA – minute of angle, POA – point of aim | | | |

I-35. Soldiers begin the Table IV task by moving into the firing position with the use of administrative commands from the tower operator. The tower operator uses administrative commands to control the flow of the range, movement of personnel, and other command and control purposes. Table I-22, on page I-22, provides an example of the administrative commands for moving a new firing order into position.

I-36. Soldiers enter the range and move to their firing points. Once at the firing point, firers assume a standing firing position with weapons in a green weapons safety status. Soldiers fire the Table IV tasks from the prone, supported position for each group.

Table I-22. Table IV, engagement 1, first shot group, conduct of fire example

| New Firing Order, Conduct of the Range | | | | | |
|--|---|--|-----------------------|--------|----------------|
| 1 2 3 | | | Task | Target | Target Type |
| | | | New Firing Order | N/A | N/A |
| | | | Rounds per Target | DODIC | Time (Seconds) |
| | | | N/A | AB57 | NO LIMIT |
| TOWER | | | SOLDIER ACTION | | |
| FIRERS ARE IN A GREEN STATUS | | | | | |
| CONDUCT OF THE RANGE | <p style="text-align: center;">FIRING ORDER (ONE) —</p> <p style="text-align: center;">SECURE YOUR WEAPON AND AMMUNITION</p> <p style="text-align: center;">ONCE COMPLETE, MOVE TO YOUR FIRING POINT.</p> <p style="text-align: center;">Soldiers secure their ammunition and magazines, and move to their designated firing point.</p> | | | | |
| FIRERS ARE IN A GREEN STATUS | | | | | |
| ONCE ALL FIRERS ARE AT THEIR FIRING POINT, THE TOWER CONTINUES. | | | | | |
| Legend: DODIC – Department of Defense identification code, N/A – not applicable | | | | | |

Note. During any engagement if a malfunction occurs, Soldiers must apply immediate action to their weapon then continue the engagement as appropriate. Where immediate or remedial action does not correct the malfunction, Soldiers notify their respective lane safety.

I-37. As soon as the tower operator confirms all firers are at the appropriate firing point, the tower operator initiates the first engagement. Table I-23 provides the commands for the first engagement.

Table I-23. Table IV, engagement 1, first shot group, conduct of fire example

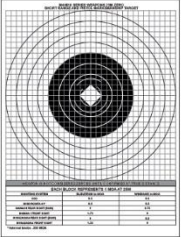
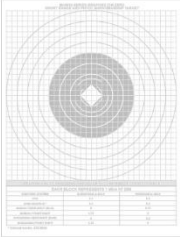
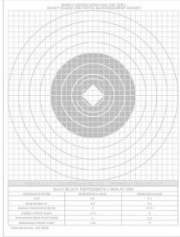
| <i>Table IV, Engagement 1 – First Shot Group</i> | | | |
|---|--|---|-----------------------|
| <div style="display: flex; justify-content: space-around;"> <div style="text-align: center;">1 </div> <div style="text-align: center;">2 </div> <div style="text-align: center;">3 </div> </div> | Group | Target | Target Type |
| | 1 | A8 | Zero / Bull Ring |
| | Rounds per Engagement | DODIC | Time (Seconds) |
| | 5 | AB57 | NO LIMIT |
| TOWER | | SOLDIER ACTION | |
| WEAPONS SAFETY STATUS RED | GO TO PRONE MAKE READY | Soldier moves to the PRONE supported position, establishes a good firing position, and loads a magazine. | |
| ALERT | FIRERS | | |
| TARGET DESCRIPTION | TARGET ONE | Soldier acquires the designated A8 target. | |
| DIRECTION | FRONT | | |
| RANGE | CLOSE QUARTERS | Soldier acquires the target and identifies the target's point of aim (POA). | |
| CONTROL | FIVE ROUNDS SLOW FIRE WEAPONS FREE WEAPONS FREE | | |
| EXECUTION | ENGAGE UPON POSITIVE IDENTIFICATION | Soldier begins slow firing a five-round shot group, ensuring the same point of aim for each round. | |
| TOWER AWAITS ALL FIRERS TO COMPLETE THE FIVE-ROUND GROUP | | | |
| TERMINATION | CEASE FIRE CEASE FIRE | The firer's BOLT should be locked to the rear. Tower must assume all weapons are RED. | |
| WEAPONS SAFETY STATUS GREEN | GO GREEN SHOW CLEAR | Soldiers clear their weapons, show clear to the lane safety. | |
| Once all firers are complete, the tower directs: MOVE TO THE TARGET AND REVIEW YOUR SHOT GROUP. ONCE COMPLETE, RETURN TO THE FIRING POINT. | | | |
| Legend: DODIC – Department of Defense identification code | | | |

I-38. Once all firers have completed the first group, the firers and coaches analyze the groups to determine if improvements to the firers’ shot processes are required and mark the groups prior to returning to the firing line. After all firers have returned from downrange, the tower operator prepares for engagement 2, shown in table I-24.

Table I-24. Table IV, engagement 2, second shot group, conduct of fire example

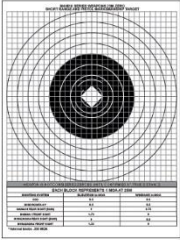
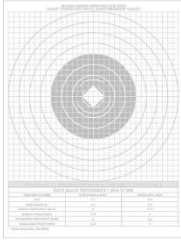
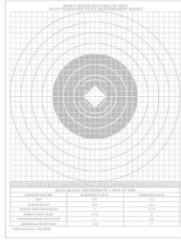
| <i>Table IV, Engagement 2 – Second Shot Group</i> | | | | | |
|---|---|---|------------------------------|---|-----------------------|
| 1 | 2 | 3 | Group | Target | Target Type |
|  |  |  | 2 | A8 | Zero / Bull Ring |
| | | | Rounds per Engagement | DODIC | Time (Seconds) |
| | | | 5 | AB57 | NO LIMIT |
| TOWER | | | SOLDIER ACTION | | |
| WEAPONS SAFETY STATUS RED | | GO TO PRONE MAKE READY | | Soldier moves to the PRONE supported position, establishes a good firing position, and loads a magazine. | |
| ALERT | | FIRERS | | | |
| TARGET DESCRIPTION | | TARGET ONE | | Soldier acquires the designated A8 target. | |
| DIRECTION | | FRONT | | | |
| RANGE | | CLOSE QUARTERS | | Soldier acquires the target and identifies the target’s point of aim (POA). | |
| CONTROL | | FIVE ROUNDS SLOW FIRE WEAPONS FREE WEAPONS FREE | | | |
| EXECUTION | | ENGAGE UPON POSITIVE IDENTIFICATION | | Soldier begins slow firing a five-round shot group, ensuring the same point of aim for each round. | |
| TOWER AWAITS ALL FIRERS TO COMPLETE THE FIVE-ROUND GROUP | | | | | |
| TERMINATION | | CEASE FIRE CEASE FIRE | | The firer’s BOLT should be locked to the rear. Tower must assume all weapons are RED. | |
| WEAPONS SAFETY STATUS GREEN | | GO GREEN SHOW CLEAR | | Soldiers clear their weapons, show clear to the lane safety. | |
| Once all firers are complete, the tower directs: MOVE TO THE TARGET AND REVIEW YOUR SHOT GROUP. ONCE COMPLETE, RETURN TO THE FIRING POINT. | | | | | |
| Legend: DODIC – Department of Defense identification code | | | | | |

I-39. After completing the second group, the firer and coach analyze the group to determine if improvements to the firer’s shot process are required and mark the group. Firers that successfully demonstrated the ability to group, make required adjustments and apply them to the aiming device. After all firers have returned to the firing line, the tower operator prepares for engagement 3 (table I-25.)

Table I-25. Table IV, engagement 3, third shot group, conduct of fire example

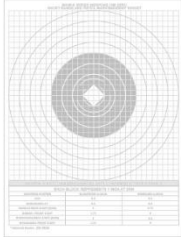
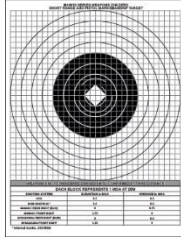
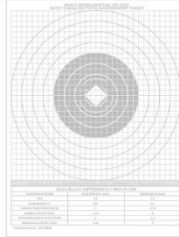
| <i>Table IV, Engagement 3 – Third Shot Group</i> | | |
|---|--|--|
| 1  | 2  | 3  |
| Group | Target | Target Type |
| 3 | A8 | Zero / Bull Ring |
| Rounds per Engagement | DODIC | Time (Seconds) |
| 5 | AB57 | NO LIMIT |
| TOWER | | SOLDIER ACTION |
| WEAPONS SAFETY STATUS RED | GO TO PRONE MAKE READY | Soldier moves to the PRONE supported position, establishes a good firing position, and loads a magazine. |
| ALERT | FIRERS | |
| TARGET DESCRIPTION | TARGET TWO | Soldier acquires the designated A8 target. |
| DIRECTION | FRONT | |
| RANGE | CLOSE QUARTERS | Soldier acquires the target and identifies the target's point of aim (POA). |
| CONTROL | FIVE ROUNDS SLOW FIRE WEAPONS FREE WEAPONS FREE | |
| EXECUTION | ENGAGE UPON POSITIVE IDENTIFICATION | Soldier begins slow firing a five-round shot group, ensuring the same point of aim for each round. |
| TOWER AWAITS ALL FIRERS TO COMPLETE THE FIVE-ROUND GROUP | | |
| TERMINATION | CEASE FIRE CEASE FIRE | The firer's BOLT should be locked to the rear. Tower must assume all weapons are RED. |
| WEAPONS SAFETY STATUS GREEN | GO GREEN SHOW CLEAR | Soldiers clear their weapons, show clear to the lane safety. |
| Once all firers are complete, the tower directs: MOVE TO THE TARGET AND REVIEW YOUR SHOT GROUP. ONCE COMPLETE, RETURN TO THE FIRING POINT. | | |
| Legend: DODIC – Department of Defense identification code | | |

I-40. Once all firers have completed the third group, annotated the appropriate adjustments on their target, and applied the adjustments to their aiming device, the tower operator prepares for engagement 4, shown in table I-26. Soldiers who have not demonstrated the ability to group should be removed from the firing line and directed to the appropriate area to receive remedial training.

Table I-26. Table IV, engagement 4, group one, conduct of fire example

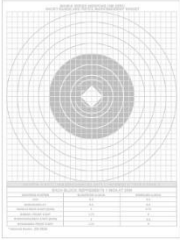
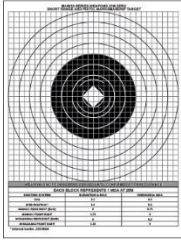
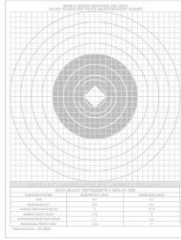
| <i>Table IV, Engagement 4 –Group One</i> | | | | | |
|---|---|---|------------------------------|---|-----------------------|
| 1 | 2 | 3 | Group | Target | Target Type |
|  |  |  | 4 | A8 | Zero / Bull Ring |
| | | | Rounds per Engagement | DODIC | Time (Seconds) |
| | | | 5 | AB57 | NO LIMIT |
| TOWER | | | SOLDIER ACTION | | |
| WEAPONS SAFETY STATUS RED | | GO TO PRONE MAKE READY | | Soldier moves to the PRONE supported position, establishes a good firing position, and loads a magazine. | |
| ALERT | | FIRERS | | | |
| TARGET DESCRIPTION | | TARGET TWO | | Soldier acquires the designated A8 target. | |
| DIRECTION | | FRONT | | | |
| RANGE | | CLOSE QUARTERS | | Soldier acquires the target and identifies the target's point of aim (POA). | |
| CONTROL | | FIVE ROUNDS SLOW FIRE WEAPONS FREE WEAPONS FREE | | | |
| EXECUTION | | ENGAGE UPON POSITIVE IDENTIFICATION | | Soldier begins slow firing a five-round shot group, ensuring the same point of aim for each round. | |
| TOWER AWAITS ALL FIRERS TO COMPLETE THE FIVE-ROUND GROUP | | | | | |
| TERMINATION | | CEASE FIRE CEASE FIRE | | The firer's BOLT should be locked to the rear. Tower must assume all weapons are RED. | |
| WEAPONS SAFETY STATUS GREEN | | GO GREEN SHOW CLEAR | | Soldiers clear their weapons, show clear to the lane safety. | |
| Once all firers are complete, the tower directs: MOVE TO THE TARGET AND REVIEW YOUR SHOT GROUP. ONCE COMPLETE, RETURN TO THE FIRING POINT. | | | | | |
| Legend: DODIC – Department of Defense identification code | | | | | |

I-41. Once all firers have completed the first zeroing group, annotated the appropriate adjustments on their target, and applied the adjustments to their aiming device, the tower operator prepares for engagement 5, shown in table I-27.

Table I-27. Table IV, engagement 5, zeroing group two, conduct of fire example

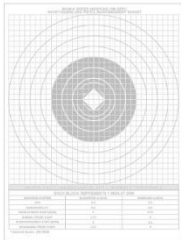
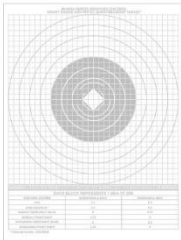
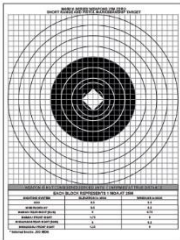
| <i>Table IV, Engagement 5 – Zeroing Group Two</i> | | | | | |
|---|---|---|---|--------|------------------|
| 1 | 2 | 3 | Zeroing Group | Target | Target Type |
|  |  |  | 1 | A8 | Zero / Bull Ring |
| | | | Rounds per Engagement | DODIC | Time (Seconds) |
| | | | 5 | AB57 | NO LIMIT |
| TOWER | | | SOLDIER ACTION | | |
| WEAPONS SAFETY STATUS RED | | GO TO PRONE MAKE READY | Soldier moves to the PRONE supported position, establishes a good firing position, and loads a magazine. | | |
| ALERT | FIRERS | | | | |
| TARGET DESCRIPTION | TARGET THREE | | Soldier acquires the designated A8 target. | | |
| DIRECTION | FRONT | | | | |
| RANGE | CLOSE QUARTERS | | Soldier acquires the target and identifies the target's point of aim (POA). | | |
| CONTROL | FIVE ROUNDS SLOW FIRE WEAPONS FREE WEAPONS FREE | | | | |
| EXECUTION | ENGAGE UPON POSITIVE IDENTIFICATION | | Soldier begins slow firing a five-round shot group, ensuring the same point of aim for each round. | | |
| TOWER AWAITS ALL FIRERS TO COMPLETE THE FIVE-ROUND GROUP | | | | | |
| TERMINATION | CEASE FIRE CEASE FIRE | | The firer's BOLT should be locked to the rear. Tower must assume all weapons are RED. | | |
| WEAPONS SAFETY STATUS GREEN | | GO GREEN SHOW CLEAR | Soldiers clear their weapons, show clear to the lane safety. | | |
| Once all firers are complete, the tower directs: MOVE TO THE TARGET AND REVIEW YOUR SHOT GROUP. ONCE COMPLETE, RETURN TO THE FIRING POINT. | | | | | |
| Legend: DODIC – Department of Defense identification code | | | | | |

I-42. Once all firers have completed zeroing group two, annotated the appropriate adjustments on their target, and applied the adjustments to their aiming device, the tower operator prepares for engagement 6, shown in table I-28.

Table I-28. Table IV, engagement 6, zeroing group three, conduct of fire example

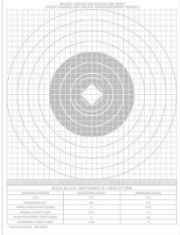
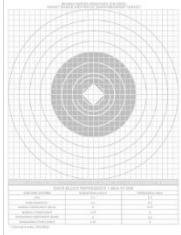
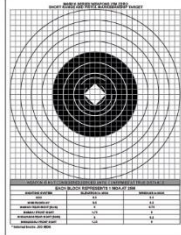
| <i>Table IV, Engagement 6 – Zeroing Group Three</i> | | | |
|---|---|---|------------------------------|
| 1 | 2 | 3 | |
|  |  |  | |
| | | | Zeroing Group |
| | | | Target |
| | | | Target Type |
| | | | 2 |
| | | | A8 |
| | | | Zero / Bull Ring |
| | | | Rounds per Engagement |
| | | | DODIC |
| | | | Time (Seconds) |
| | | | 5 |
| | | | AB57 |
| | | | NO LIMIT |
| TOWER | | | SOLDIER ACTION |
| WEAPONS SAFETY STATUS RED | GO TO PRONE MAKE READY | Soldier moves to the PRONE supported position, establishes a good firing position, and loads a magazine. | |
| ALERT | FIRERS | | |
| TARGET DESCRIPTION | TARGET THREE | Soldier acquires the designated A8 target. | |
| DIRECTION | FRONT | | |
| RANGE | CLOSE QUARTERS | Soldier acquires the target and identifies the target's point of aim (POA). | |
| CONTROL | FIVE ROUNDS SLOW FIRE WEAPONS FREE WEAPONS FREE | | |
| EXECUTION | ENGAGE UPON POSITIVE IDENTIFICATION | Soldier begins slow firing a five-round shot group, ensuring the same point of aim for each round. | |
| TOWER AWAITS ALL FIRERS TO COMPLETE THE FIVE-ROUND GROUP | | | |
| TERMINATION | CEASE FIRE CEASE FIRE | The firer's BOLT should be locked to the rear. Tower must assume all weapons are RED. | |
| WEAPONS SAFETY STATUS GREEN | GO GREEN SHOW CLEAR | Soldiers clear their weapons, show clear to the lane safety. | |
| Once all firers are complete, the tower directs: MOVE TO THE TARGET, REVIEW YOUR SHOT GROUP, REMOVE TARGETS AND REPLACE WITH FRESH TARGETS. ONCE COMPLETE, RETURN TO THE FIRING POINT. | | | |
| Legend: DODIC – Department of Defense identification code | | | |

I-43. Once all firers have recovered their targets and placed fresh A8 targets on the target frame, firers collect their brass, ammunition, and magazines from their firing position, then the lane safety clears them. Once complete, the lane safety communicates the WSS to the tower operator, and the tower operator issues an administrative command moving the completed Soldiers off the range.

I-44. The tower may direct certain firers to remain on the firing point, as necessary. This includes Soldiers who have been assigned both a pointer, illuminator, laser and a thermal weapon sight, and still need to zero the second aiming device. Those Soldiers require additional ammunition to complete the requisite tasks.

I-45. During the range reconnaissance, the unit determines if the 25-meter target frame interferes with the firer's ability to acquire and engage the zero confirmation target. Where the 25-meter target frame presents a line-of-sight issue to the zero confirmation target, units should bypass the confirmation process. When the zero confirmation target cannot be safely or effectively used with the 25-meter target frame emplaced, units conduct confirmation at distance (one each, five-round magazine) by—

- Completing all firing orders through grouping and zeroing tasks, then removing the target frames from the range while in a cold or dry status.
- Completing stage 3 confirmation at distance and stage 4 application of hold-offs prior to conducting Table V (when using a separate facility).

I-46. The conduct of fire for stages 3 and 4 is provided in table I-29, on page I-30. All firers must complete adjustments to their aiming devices and recorded their final zero information for their weapon and optic prior to confirming at distance. All weapons are initially in a green status.

Table I-29. Table IV, engagement 7, confirmation at distance, conduct of fire example

| <i>Table IV, Engagement 7 – Zero Confirmation at Distance</i> | | | |
|--|--|---|---|
| <p style="text-align: center;">300 meter (Unit may select different zero range based on their SOP, TTP, or mission requirements).</p> | Zero Confirmation | Target | Target Type |
| | 1 | E-1 or D-1 | Silhouette, kneeling (hit-bob mode) |
| | Rounds per Engagement | DODIC | Time (Seconds) |
| | 5 | AB57 | NO LIMIT |
| TOWER | | SOLDIER ACTION | |
| WEAPONS SAFETY STATUS RED | GO TO PRONE MAKE READY | Soldier moves to the PRONE supported position, establishes a good firing position, and loads a magazine. | |
| ALERT | FIRERS | | |
| TARGET DESCRIPTION | TROOP | Soldier acquires the zero confirmation target. | |
| DIRECTION | FRONT | | |
| RANGE | THREE-HUNDRED | Soldier acquires the target and identifies the target's center of visible mass (known as CoVM). | |
| CONTROL | FIVE ROUNDS SLOW FIRE WEAPONS FREE WEAPONS FREE | | |
| EXECUTION | ENGAGE UPON POSITIVE IDENTIFICATION | Soldier begins slow firing a five-round shot group, ensuring the same point of aim for each round. | |
| ONCE ALL FIRERS ARE COMPLETE WITH THE FIVE-ROUND CONFIRMATION AT DISTANCE: | | | |
| TERMINATION | CEASE FIRE CEASE FIRE | The firer's BOLT should be locked to the rear. Tower must assume all weapons are RED. | |
| WEAPONS SAFETY STATUS GREEN | GO GREEN SHOW CLEAR | Soldiers clear their weapons, show clear to the lane safety. | |
| Firer's should achieve four of five hits to successfully complete confirmation at distance. The tower should identify any firer that has not met the confirmation standard and move those Soldiers to the retraining location. | | | |
| Legend: DODIC – Department of Defense identification code, SOP – standard operating procedure, TTP – tactics, techniques, and procedures | | | |

I-47. Once all firers have completed stage 3, they remain in place and await further instructions from the tower operator. The tower operator instructs them to reload and prepare for stage 4. Table I-30 shows an example of the conduct of fire for Table IV, Stage 4.

Table I-30. Table IV, engagement 8, application of hold-offs, conduct of fire example

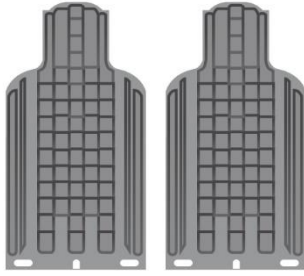
| <i>Table IV, Engagement 8 – Application of Hold-Offs</i> | | | |
|---|--|--|-------------------------------------|
|  <p>100 and 200 meter</p> | Application of Hold-Offs | Target | Target Type |
| | 1 | E-1 or D-1 | Silhouette, kneeling (hit-bob mode) |
| | Rounds per Engagement | DODIC | Time (Seconds) |
| | 10 | AB57 | 55 |
| TOWER | | SOLDIER ACTION | |
| WEAPONS SAFETY STATUS RED | MAKE READY | Soldier remains in the PRONE supported position, establishes a good firing position, and loads one 10-round magazine. | |
| ALERT | FIRERS | | |
| TARGET DESCRIPTION | TROOPS | Soldier acquires the 100 meter target. | |
| DIRECTION | FRONT | | |
| RANGE | ONE-HUNDRED AND TWO HUNDRED | Soldier acquires the target and identifies the target's center of visible mass (known as CoVM). | |
| CONTROL | FIVE ROUNDS SLOW FIRE WEAPONS FREE WEAPONS FREE | | |
| EXECUTION | ENGAGE UPON POSITIVE IDENTIFICATION | Soldier begins slow firing a five-round shot group, applying the appropriate hold-off at the 100 meter target and again at the 200 meter target. | |
| ONCE ALL FIRERS ARE COMPLETE WITH THE 10-ROUND APPLICATION OF HOLD-OFF | | | |
| TERMINATION | CEASE FIRE CEASE FIRE | The firer's BOLT should be locked to the rear. Tower must assume all weapons are RED. | |
| WEAPONS SAFETY STATUS GREEN | GO GREEN SHOW CLEAR | Soldiers clear their weapons, show clear to the lane safety. | |
| Firer's should achieve four of five hits on each target to successfully complete application of hold-offs. The tower should identify any firer that has not met the standard and move those Soldiers to the retraining location. | | | |
| Legend: DODIC – Department of Defense identification code, SOP – standard operating procedure, TTP – tactics, techniques, and procedures, | | | |

I-48. Once all firers have been verified green by the lane safety, the tower operator directs the firing order off the baseline. The tower operator must identify Soldiers who have failed to achieve the confirmation at distance standard (4 of 5 hits at zeroing distance) and move those Soldiers to a predetermined retraining location.

I-49. Table I-31 provides a generic example of the conduct of the range instructions to change firing orders. All firers on the range are in a green status.

Table I-31. Table IV, completed firing order, conduct of the range example

| Completed Firing Order, Conduct of the Range | | | |
|---|--|-----------------------|--|
|  <p>FIRING ORDER COMPLETE</p> | Task | Target | Target Type |
| | Completed Firing Order | N/A | N/A |
| | Rounds per Target | DODIC | Time (Seconds) |
| | N/A | N/A | NO LIMIT |
| TOWER | | SOLDIER ACTION | |
| FIRERS ARE IN A GREEN STATUS | | | |
| CONDUCT OF THE RANGE | SECURE YOUR DUNNAGE, MAGAZINES, AND AMMUNITION ONCE SET, MOVE TO THE BASELINE ENTRY CONTROL POINT | | Firers secure weapon and ammunition dunnage and move to the designated location. |
| ONCE ALL FIRERS HAVE EXITED THROUGH THE BASELINE ENTRY CONTROL POINT, THE TOWER DIRECTS THE MOVEMENT OF THE NEXT FIRING ORDER. | | | |
| Legend: DODIC – Department of Defense identification code, N/A – not applicable | | | |

I-50. Leaders review the shot groups with their Soldiers and collect their grouping and zeroing targets for an AAR and verification of zeroing data. Leaders should maintain a record of the zeroing information, and review the targets for any firer errors during the shot process.

I-51. The tower operator records the completion of the firing order in the tower log and includes the number of Soldiers trained. The tower operator tabulates this information is tabulated at the end of the firing day to change the firing status of the range to a cold and dry status with range operations.

ASSISTED NIGHT FIRE, TABLE V, PRACTICE

I-52. Table V, Practice, is a practice table used in preparation for the certification course of fire. Table V tasks challenge firers with single and multiple stationary targets between 50- and 300-meters, from the prone unsupported, prone supported, kneeling supported, and standing supported firing positions. Table V tasks train the firer to engage single and multiple targets placed in a tactical array using their assigned, limited visibility aiming device and apply the functional elements of the shot process. In a timed scenario, the firer experiences and learns target prioritization and weapons manipulation. This event is purposefully more rigorous than the certification event where the targets are presented in a rapid tempo, and the time to transition between firing positions and tactical reloading are reduced.

TASK, CONDITIONS, AND STANDARD

I-53. Table I-32 outlines the task, conditions, and standard for conducting Table V actions. During the range briefing, the leader explains the task, conditions, and standard to the firer conducting the event.

Table I-32. Assisted night fire, Table V, Practice

| | |
|--------------------|---|
| Task: | Engage and defeat single and multiple threats at varying ranges from supported or unsupported standing, kneeling, and prone firing positions, during day and limited visibility and simulated chemical environment conditions using ball ammunition. |
| Conditions: | Given the following: <ul style="list-style-type: none"> • Fully mission capable weapon and aiming device as assigned on the master authorization list for the unit. • Full combat uniform, issued equipment, and protective mask. • Authorized range facility. • Full-scale, approved targetry in standard scenario engagement sequences. • Authorized ammunition. |
| Standard: | Demonstrate engagement proficiency by hitting 70 percent (35 of 50) of all presented targets within the time allotted. |

I-54. Table I-33, on page I-34, shows the training event design template for Assisted Night Fire, Table V, Practice. Leaders conduct this event on an authorized live-fire facility, typically an ARF or comparable range facility. See TC 25-8 for additional information on authorized range facilities.

Table I-33. Training event design template for assisted night fire, Table V, Practice

| <i>Assisted Night Fire, Table V, Practice</i> | | | | | | |
|--|--------------------------|---------------------------|-------------------------|---------------------------------------|--------------------------|---------------------------------|
| EVENT NAME: | PRACTICE | ENVIRONMENT: | | LIVE | 1.0 | |
| WEAPON: | M4 / M16 / M249AR | CONDITIONS: | | LIVE FIRE | | |
| CATEGORY: | CERTIFICATION | PRIMARY FACILITY: | | ARF | DAYS REQUIRED | |
| PUBLICATION: | TC 3-22.9 TC 3-22.249 | ALTERNATE FACILITY: | | QTR | | |
| REQUIRED: | NO | COMPONENT: | AC | RC | 120 SOLDIERS | |
| RECORD: | DA Form 7489 | FREQUENCY: | 2 | 1 | | |
| VALID FOR: | T-X | ANNUAL DAYS TOTAL: | 2 | 1 | THROUGHPUT | |
| | TABLE | | | | | |
| | I | II | III | IV | V | VI |
| | PMI&E | PLFS | DRILLS | BASIC | PRACTICE | CERT |
| | PRQ | PRQ | PRQ | | | 1.0 |
| WHEN EXECUTED: | | | | | T-X | TNG DAYS TO CERT |
| CONDEMNATION CRITERIA (CC) | RULE 1 | RULE 2 | RULE 3 | RULE 4 | RULE 5 | RULE 6 |
| | TIME | KEY LEADER TURNOVER | COMMANDER ASSESSMENT | SUBORDINATE ELEMENT PROFICIENCY | SPECIALTY PROFICIENCY | STAFF SECTION PROFICIENCY |
| Remarks: Each Soldier assigned a limited visibility aiming device <i>should</i> successfully complete Table V, Practice, to gain experience with and confidence in their weapon, aiming devices, and skill. | | | | | | |
| Legend: AC – active component (*known as active duty), ARF – automated record fire range or similar, AR – automatic rifle, CERT – certification, DA – Department of the Army, EVAL – evaluation, PLFS – preliminary live-fire simulation, PMI&E – preliminary marksmanship instruction and evaluation, PRQ – prerequisite, QTR – qualification training range, RC – Reserve Component (known as Reserves), TC – training circular, TNG DAYS TO CERT – number of training days remaining on the critical path to weapon’s certification, T-X – training event exercise | | | | | | |

AMMUNITION

I-55. All Soldiers assigned a limited, visibility aiming device on a unit MAL should complete Assisted Night Fire, Table V, Practice, prior to advancing to Table VI, Certification. Leaders conduct this event to demonstrate the Soldier’s proficiency in lethally employing a rifle, carbine, or automatic rifle equipped with a limited, visibility aiming device prior to conducting the certification course of fire, Table VI.

I-56. To effectively plan and forecast for sufficient training ammunition, the unit will use the ammunition requirements listed in table I-34. Units need to identify the total number of firers and should plan for unscheduled firers and necessary retraining by increasing their forecasted training.

Table I-34. Assisted night fire, Table V, Practice ammunition requirements

| Training Event | DODIC | Nomenclature | Quantity | Remarks |
|---|-------|--|----------|--|
| All Weapons | | | | |
| Table IV, Stage 3, Confirmation at Distance | AB57 | CTG, 5.56mm, ball, M855A1 EPR | 5 | Conducted prior to Table V on the ARF or comparable facility when range restrictions or line-of-sight issues prevent completion of the task during Table IV. |
| Table IV, Stage 4 Application of Hold-Offs | AB57 | CTG, 5.56mm, ball, M855A1 EPR | 10 | Conducted prior to Table V on the ARF or comparable facility when range restrictions or line-of-sight issues prevent completion of the task during Table IV. |
| M4 / M16 | | | | |
| Table V, Stage 1, Practice | AB57 | CTG, 5.56mm, ball, M855A1 EPR | 40 | One round per target is required. |
| Table V, Stage 2, Practice | AB57 | CTG, 5.56mm, ball, M855A1 EPR | 10 | One round per target is required. |
| M249AR | | | | |
| Table V, Stage 1, Practice | AB73 | CTG, 5.56mm linked (4:1) M855A1 (ball) and M856A1 (tracer) | 150 | 3 to 5 round burst per target is required. |
| | AB57 | CTG, 5.56mm, ball, M855A1 EPR | 50 | 3 to 5 round burst per target is required. |
| Table V, Stage 2, Practice | AB73 | CTG, 5.56mm linked (4:1) M855A1 (ball) and M856A1 (tracer) | 50 | 3 to 5 round burst per target is required. |
| Legend: ARF – automated record fire range, AR – automatic rifle, CTG – cartridge, DODIC – Department of Defense identification code, EPR – enhanced performance round, mm – millimeter | | | | |

I-57. Table V tasks are automated, timed events that consist of five, live-fire phases divided into two stages. Stage 1 consists of the first four phases followed by fifth stage, which comprises stage 2. Leaders issue every firer ammunition, as shown in table I-34, to conduct the event to standard.

I-58. The ammunition NCO with a supporting detail (ammunition detail) loads the magazines with training ammunition as shown in table I-35 on page I-36. They issue M4 and M16 firers five, 10-round magazines. The NCO issues M249 automatic rifle firers four, 50-round belts and two, 25-round magazines. Firers place ammunition in their ammunition pouches. Staging or pre-positioning ammunition is not authorized for the conduct of the Table V task.

Table I-35. Assisted night fire, Table V, Practice ammunition breakdown

| <i>Phase</i> | <i>Sequence</i> | <i>M4 / M16</i> | <i>M249AR</i> | |
|---|-----------------|------------------------------|--|------------------------------|
| | | <i>AB57 5.56mm, Ball</i> | <i>AB73 5.56mm, Ball, Linked</i> | <i>AB57 5.56mm, Ball</i> |
| Stage 1 | | | | |
| Prone, Unsupported | 1 | 10 each | 50 round belt | |
| Prone, supported | 2 | 10 each | 50 round belt | |
| Kneeling, Supported | 3 | 10 each | | 25 each |
| | | | | 25 each |
| Standing, Supported | 4 | 10 each | 50 round belt | |
| Stage 2 | | | | |
| Standing Supported, CBRN | 5 | 10 each | 50 round belt | |
| Legend: AR – automatic rifle, CBRN – chemical, biological, radiological, and nuclear, mm – millimeter | | | | |

RANGE FACILITIES

I-59. Table I-36 shows the Army-standard range facilities designed to support Assisted Night Fire, Table V, Practice tasks. Units must refer to their installation’s range operations SOPs or local training regulation to identify the weapon-specific range facilities. Units use their RFMSS system for all scheduling.

Table I-36. Assisted night fire, Table V, Practice authorized range facilities

| Table V | Targetry | Range Facility | |
|---|---|----------------|-----|
| | | ARF | QTR |
| Practice | E-type, E1, target, silhouette: plastic, polyethylene, kneeling (NSN: 6920-00-071-4780) F-type, F-1, target, silhouette: plastic, polyethylene, prone (NSN 6920-00-071-4589) | P | A |
| | D-type, D1, target, silhouette: plastic, mannequin, kneeling (NSN 6920-01-164-9625) D-type, D-2, target, 3-dimensional: plastic, mannequin, prone (NSN 6920-01-387-6397) | P | A |
| Legend: A – alternate, ARF- automated record fire range, NSN – national stock number, P – primary, QTR – qualification training range | | | |

TARGETRY

I-60. Table V requires silhouette targetry, either E-type, F-type, or D-type targets on the range. The leader must confirm the type and capability of the range's targetry, lifting mechanisms, and simulators and identify any unit requirements. During the preparation phase, leaders should be familiar with the targetry used and the sequence of the firing events. Figure I-3, on page I-38, shows the authorized targetry used during Table V.





| | |
|--|--|
| <p align="center">E-1 Target, silhouette: plastic, polyethylene, kneeling NSN 6920-00-071-4780</p> | <p align="center">D-1 Target, 3-dimensional: plastic, mannequin, kneeling NSN 6920-01-164-9625</p> |
|  |  |
| <p align="center">F-1 Target, silhouette: plastic, polyethylene, prone NSN 6920-00-071-4589</p> | <p align="center">D-2 Target, 3-dimensional: plastic, mannequin, prone NSN 6920-01-387-6397</p> |
|  <p align="center">Prone targets are only used on the 50-meter RIGHT emplacement.</p> |  <p align="center">Prone targets are only used on the 50-meter RIGHT emplacement.</p> |
| <p>Notes:</p> <p>Use of E-1 or D-1 kneeling targets is at the discretion of the installation. Both represent dismounted, kneeling Infantry targets on small arms and maneuver facilities.</p> <p>Use F-1 or D-2 on the right 50-meter target emplacement only.</p> <p>Use of G-2 prone targets is not authorized.</p> | |
| <p>Legend: NSN – national stock number</p> | |

Figure I-3. Table V, authorized target types

SCENARIO ENGAGEMENTS

I-61. Targets are presented to the firer in single and multiple target arrays. Targets are presented such that 90 percent of the target is clearly visible to the firer from the expected or planned firing position. Targets are exposed to the firer based on the number of targets presented during the engagement:

- Single target engagements are exposed for 3 seconds.
- Double target engagements are exposed for 5 seconds.
- Triple target engagements are exposed for 12 seconds.
- Quadruple target engagements are exposed for 16 seconds.

I-62. There is a 2-second delay between each engagement. After each phase (prone unsupported, prone supported, kneeling supported, and standing supported), there is an 8-second transition delay giving the firer time to conduct an emergency reload and to assume the next specified position. There is a 60-second transition delay between stage 1 and stage 2 to allow firers to don protective equipment, change the M249 automatic rifle barrel, and reload. Table I-37 shows the scenario engagement sequence for Table V engagements.

Table I-37. Assisted night fire Table V, Practice, engagement sequence

| <i>Table V, Practice, Engagements 1 through 5, React to Contact, Transition to Prone, Unsupported</i> | | | |
|---|--------------------|---------------|----------------------|
| <i>Engagement</i> | <i>Target Type</i> | <i>Range</i> | <i>Exposure Time</i> |
| Phase 1 | | | |
| 1 | F-type | 50 m RIGHT | 3 sec |
| 2 | E-type | 100 m | 3 sec |
| 3 | E-type | 150 m | 3 sec |
| 4 | E-type | 50 m LEFT | 12 sec |
| | E-type | 150 m | |
| | E-type | 200 m | |
| 5 | E-type | 150 m | 16 sec |
| | E-type | 200 m | |
| | E-type | 250 m | |
| | E-type | 300 m | |
| Prone, Unsupported, Time per Firing Order Total | | | 56 sec |
| <p>Note: There is a 5-second delay between the first and second engagement to allow the Soldier to go to prone. There is a 2-second delay between all other engagements in this table. An 8-second delay time is incorporated at the end of engagement 5 to facilitate reload and firing position changes.</p> | | | |

Table I-37. Assisted night fire, Table V, Practice engagement sequence (continued)

| <i>Table V, Practice, Engagements 6 through 10, Prone, Supported</i> | | | |
|--|--------------------|--------------|----------------------|
| <i>Engagement</i> | <i>Target Type</i> | <i>Range</i> | <i>Exposure Time</i> |
| 6 | E-type | 100 m | 3 sec |
| 7 | E-type | 150 m | 5 sec |
| | E-type | 300 m | |
| 8 | E-type | 200 m | 5 sec |
| | E-type | 300 m | |
| 9 | E-type | 250 m | 5 sec |
| | E-type | 300 m | |
| 10 | E-type | 150 m | 12 sec |
| | E-type | 250 m | |
| | E-type | 300 m | |
| Prone, Supported, Time per Firing Order Total | | | 46 sec |
| Note: There is a 2-second delay between all engagements. An 8-second delay time is incorporated at the end of engagement 10 to facilitate reload and firing position changes. | | | |

Table I-37. Assisted night fire, Table V, Practice engagement sequence (continued)

| <i>Table V, Practice, Engagements 11 through 14, Kneeling, Supported</i> | | | |
|--|--------------------|---------------|----------------------|
| <i>Engagement</i> | <i>Target Type</i> | <i>Range</i> | <i>Exposure Time</i> |
| 11 | E-type | 50 m LEFT | 12 sec |
| | E-type | 100 m | |
| | E-type | 200 m | |
| 12 | F-type | 50 m RIGHT | 5 sec |
| | E-type | 200 m | |
| 13 | E-type | 150 m | 5 sec |
| | E-type | 250 m | |
| 14 | E-type | 100 m | 12 sec |
| | E-type | 150 m | |
| | E-type | 200 m | |
| Kneeling, Supported, Time per Firing Order Total | | | 48 sec |
| Note: There is a 2-second delay between all engagements. An 8-second delay time is incorporated at the end of engagement 14 to facilitate reload and firing position changes. | | | |

Table I-37. Assisted night fire, Table V, Practice engagement sequence (continued)

| <i>Table V, Practice, Engagements 15 through 18, Standing, Supported</i> | | | |
|---|--------------------|---------------|----------------------|
| <i>Engagement</i> | <i>Target Type</i> | <i>Range</i> | <i>Exposure Time</i> |
| 15 | E-type | 50 m LEFT | 5 sec |
| | E-type | 100 m | |
| 16 | E-type | 200 m | 5 sec |
| | E-type | 250 m | |
| 17 | F-type | 50 m RIGHT | 12 sec |
| | E-type | 100 m | |
| | E-type | 150 m | |
| 18 | E-type | 100 m | 12 sec |
| | E-type | 200 m | |
| | E-type | 250 m | |
| Standing, Supported, Time per Firing Order Total | | | 100 sec |
| Note: There is a 2-second delay between all engagements. A 60-second delay time is incorporated at the end of engagement 18 to facilitate donning protective equipment, changing the M249AR barrel, and reloading. | | | |

Table I-37. Assisted night fire, Table V, Practice engagement sequence (continued)

| <i>Table V, Practice, Engagements 19 through 22, Standing, Supported</i> | | | |
|---|--------------------|---------------|----------------------|
| <i>Engagement</i> | <i>Target Type</i> | <i>Range</i> | <i>Exposure Time</i> |
| Phase 2 (CBRN) | | | |
| 19 | E-type | 50 m LEFT | 5 sec |
| | E-type | 100 m | |
| 20 | E-type | 200 m | 5 sec |
| | E-type | 250 m | |
| 21 | F-type | 50 m RIGHT | 12 sec |
| | E-type | 100 m | |
| | E-type | 150 m | |
| 22 | E-type | 100 m | 12 sec |
| | E-type | 250 m | |
| | E-type | 300 m | |
| CBRN, Standing, Supported, Time per Firing Order Total | | | 40 sec |
| Note: There is a 2-second delay between all engagements. | | | |
| Legend: AR – automatic rifle, CBRN – chemical, biological, radiological and nuclear; m – meters; sec – seconds | | | |

I-63. Table I-38, on page I-44, provides the Table V, Practice throughput schedule. Table V is a guide to units that portrays the overall efficiency of the range facility when conducting the training event. Table V provides the overall throughput timetable based on the time the unit requires to remove one firing order from their firing positions and move the next firing order forward.

I-64. Three general movement schedules are available to administer firing order placements on the range, 2 minutes, 5 minutes, and 10 minutes. The more proficient a unit is at operating a small arms range facility, the greater the firer throughput on the facility. This schedule does not include time required for retraining, refire, or firers who have persistent problems using a reticle.

Table I-38. Assisted night fire, Table V, Practice, throughput time schedule

| <i>Phase</i> | | <i>Time to Execute</i> | | <i>Remarks</i> | |
|--|---|------------------------|---------------|---|----------------|
| Prone, Unsupported | | 0:56 seconds | | Includes 2-seconds between engagements and 8-seconds transition to next phase. | |
| Prone, Supported | | 0:46 seconds | | | |
| Kneeling, Supported | | 0:48 seconds | | | |
| Standing, Supported | | 1:40 seconds | | Includes 2-seconds between engagements and 60-seconds between stages. | |
| CBRN, Standing, Supported | | 0:40 seconds | | Includes 2-seconds between engagements. | |
| Total Time Per Firing Order | | 4:50 minutes | | Does not include administrative time to move firing order to or from their respective firing positions. | |
| <i>Total Number of Firing Orders</i> | <i>Table V Execution with Administration Time Between Firing Orders</i> | | | <i>Total Firer Throughput based on Range Configuration</i> | |
| | <i>2 min</i> | <i>5 min</i> | <i>10 min</i> | <i>16 Lane</i> | <i>32 Lane</i> |
| 2 | 14 min | 20 min | 30 min | 32 | 64 |
| 3 | 20 min | 29 min | 44 min | 48 | 96 |
| 4 | 27 min | 39 min | 59 min | 64 | 128 |
| 5 | 34 min | 49 min | 1 hr 14 min | 80 | 160 |
| 6 | 41 min | 59 min | 1 hr 29 min | 96 | 192 |
| 7 | 47 min | 1 hr 8 min | 1 hr 43 min | 112 | 224 |
| 8 | 54 min | 1 hr 18 min | 1 hr 58 min | 128 | 256 |
| 9 | 1 hr 1 min | 1 hr 28 min | 2 hrs 13 min | 144 | 288 |
| 10 | 1 hr 8 min | 1 hr 38 min | 2 hrs 28 min | 160 | 320 |
| 11 | 1 hr 15 min | 1 hr 48 min | 2 hrs 43 min | 176 | 352 |
| 12 | 1 hr 21 min | 1 hr 57 min | 2 hrs 57 min | 192 | 384 |
| 13 | 1 hr 28 min | 2 hrs 7 min | 3 hrs 12 min | 208 | 416 |
| 14 | 1 hr 35 min | 2 hrs 17 min | 3 hrs 27 min | 224 | 448 |
| 15 | 1 hr 42 min | 2 hrs 27 min | 3 hrs 42 min | 240 | 480 |
| 16 | 1 hr 49 min | 2 hrs 37 min | 3 hrs 57 min | 256 | 512 |
| 17 | 1 hr 55 min | 2 hrs 46 min | 4 hrs 11 min | 272 | 544 |
| 18 | 2 hrs 2 min | 2 hrs 56 min | 4 hrs 26 min | 288 | 576 |
| 19 | 2 hrs 9 min | 3 hrs 6 min | 4 hrs 41 min | 304 | 608 |
| 20 | 2 hrs 16 min | 3 hrs 16 min | 4 hrs 56 min | 320 | 640 |
| Legend: CBRN – chemical, biological, radiological, and nuclear, hr – hour; hrs – hours, min – minutes | | | | | |

CONDUCT OF THE RANGE

I-65. Leaders instruct Soldiers on the objectives of Table V and the importance of the functional elements of the shot process. Table V contains 22 firing tasks with an administrative pause programmed at the end of each phase to facilitate emergency reloading and changing positions.

I-66. Soldiers enter the range and move to their firing points. Once at the firing point, firers assume a standing firing position with rifle and carbines in a green status. Soldiers fire Table V tasks from the ready at varying firing positions throughout the duration of the course of fire, where—

- Tasks 1 through 5 are fired from the prone, unsupported firing position.
- Tasks 6 through 10 are fired from the prone, supported firing position.
- Tasks 11 through 14 are fired from the kneeling, supported firing position.
- Tasks 15 through 18 are fired from the standing, supported firing position.
- Tasks 19 through 22 are fired from the standing, supported firing position in a simulated chemical environment.

I-67. Firers must hit a minimum of 35 of the 50 targets presented (70 percent) to successfully pass this event. Soldiers are not required to successfully complete Table V tasks before conducting Table VI. This event is purposefully more rigorous than the certification event where the targets are presented in a rapid tempo, and the time to transition between firing positions and tactical reloading are reduced. The leader annotates the official record of training on DA Form 7489.

I-68. Soldiers begin Table V tasks by moving into the firing position following administrative commands from the tower operator. Tower operators use administrative commands to control the flow of the range, movement of personnel, and other command and control purposes. Table I-39 provides an example of the administrative commands for moving a new firing order into position.

Table I-39. Table V, new firing order, conduct of the range example

| <i>New Firing Order, Conduct of the Range</i> | | | |
|--|---|--|-----------------------|
| PRACTICE | Task | Target | Target Type |
| | New Firing Order | N/A | N/A |
| | Rounds per Target | DODIC | Time (Seconds) |
| | N/A | AB57/ AB73 | NO LIMIT |
| TOWER | | SOLDIER ACTION | |
| CONDUCT OF THE RANGE | SECURE YOUR AMMUNITION AND MOVE TO YOUR FIRING POINT | Soldiers secure their weapon in a GREEN status, their training ammunition in four magazines, and move to the designated firing point. | |
| ONCE ALL FIRERS ARE COMPLETE, CONDUCT OF THE RANGE CONTINUES. | | | |
| Legend: DODIC – Department of Defense identification code, N/A – not applicable | | | |

I-69. If the unit cannot complete the zero confirmation task during the Table IV event, the unit must provide one each five-round magazine to each firer (249 automatic rifle firers receive five one-round magazines). The firing order conducts the confirm zero at distance task prior to beginning Table V tasks. This may be done sequentially (recommended), or the unit may conduct all required zero confirmations prior to initiating Table V. Units can follow the following guide (table I-40, on page I-46) to complete the confirmation at distance task. Firers are in a green status at their assigned firing point.

Table I-40. Table IV, engagement 7, confirmation at distance, conduct of fire example

| <i>Table IV, Engagement 7 – Zero Confirmation at Distance</i> | | | |
|--|--|---|-------------------------------------|
|  <p>300 meter (Unit may select different zero range based on their SOP, TTP, or mission requirements).</p> | Zero Confirmation | Target | Target Type |
| | 1 | E-1 or D-1 | Silhouette, kneeling (hit-bob mode) |
| | Rounds per Engagement | DODIC | Time (Seconds) |
| | 5 | AB57 | NO LIMIT |
| TOWER | | SOLDIER ACTION | |
| WEAPONS SAFETY STATUS RED | GO TO PRONE MAKE READY | Soldier moves to the PRONE supported position, establishes a good firing position, and loads a magazine. | |
| ALERT | FIRERS | | |
| TARGET DESCRIPTION | TROOP | Soldier acquires the zero confirmation target. | |
| DIRECTION | FRONT | | |
| RANGE | THREE-HUNDRED | Soldier acquires the target and identifies the target's center of visible mass (known as CoVM). | |
| CONTROL | FIVE ROUNDS SLOW FIRE WEAPONS FREE WEAPONS FREE | | |
| EXECUTION | ENGAGE UPON POSITIVE IDENTIFICATION | Soldier begins slow firing a five-round shot group, ensuring the same point of aim for each round. | |
| ONCE ALL FIRERS ARE COMPLETE WITH THE FIVE-ROUND CONFIRMATION AT DISTANCE: | | | |
| TERMINATION | CEASE FIRE CEASE FIRE | The firer's BOLT should be locked to the rear. Tower must assume all weapons are RED. | |
| WEAPONS SAFETY STATUS GREEN | GO GREEN SHOW CLEAR | Soldiers clear their weapons, show clear to the lane safety. | |
| Firer's should achieve four of five hits to successfully complete confirmation at distance. The tower should identify any firer that has not met the confirmation standard and move those Soldiers to the retraining location. | | | |
| Legend: DODIC – Department of Defense identification code, SOP – standard operating procedure, TTP – tactics, techniques, and procedures | | | |

I-70. Once all firers have completed stage 3, they remain in place and await further instructions from the tower operator. The tower operator instructs them to reload and prepare for stage 4. Table I-41 shows an example of the conduct of fire for Table IV, Stage 4.

Table I-41. Table IV, engagement 8, application of hold-offs, conduct of fire example

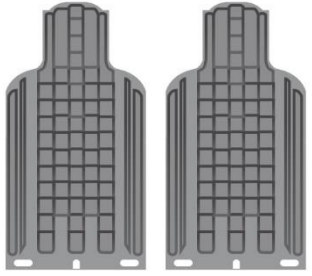
| <i>Table IV, Engagement 8 – Application of Hold-Offs</i> | | | |
|---|--|--|-------------------------------------|
|  <p>100 and 200 meter</p> | Application of Hold-Offs | Target | Target Type |
| | 1 | E-1 or D-1 | Silhouette, kneeling (hit-bob mode) |
| | Rounds per Engagement | DODIC | Time (Seconds) |
| | 10 | AB57 | 55 |
| TOWER | | SOLDIER ACTION | |
| WEAPONS SAFETY STATUS RED | MAKE READY | Soldier remains in the PRONE supported position, establishes a good firing position, and loads one 10-round magazine. | |
| ALERT | FIRERS | | |
| TARGET DESCRIPTION | TROOPS | Soldier acquires the 100 meter target. | |
| DIRECTION | FRONT | | |
| RANGE | ONE-HUNDRED AND TWO HUNDRED | Soldier acquires the target and identifies the target's center of visible mass (known as CoVM). | |
| CONTROL | FIVE ROUNDS SLOW FIRE WEAPONS FREE WEAPONS FREE | | |
| EXECUTION | ENGAGE UPON POSITIVE IDENTIFICATION | Soldier begins slow firing a five-round shot group, applying the appropriate hold-off at the 100 meter target and again at the 200 meter target. | |
| ONCE ALL FIRERS ARE COMPLETE WITH THE 10-ROUND APPLICATION OF HOLD-OFF: | | | |
| TERMINATION | CEASE FIRE CEASE FIRE | The firer's BOLT should be locked to the rear. Tower must assume all weapons are RED. | |
| WEAPONS SAFETY STATUS GREEN | GO GREEN SHOW CLEAR | Soldiers clear their weapons, show clear to the lane safety. | |
| Firer's should achieve four of five hits on each target to successfully complete application of hold-offs. The tower should identify any firer that has not met the standard and move those Soldiers to the retraining location. | | | |
| Legend: DODIC – Department of Defense identification code, SOP – standard operating procedure, TTP – tactics, techniques, and procedures, | | | |

I-71. The following engagement sequence guide initiates the Table V scenario. The engagement sequence with a generic conduct of fire process for the tower is provided in tables I-42 through I-47, on pages I-49 through I-53.

Table I-42. Table V, engagement 1 through 5, conduct of fire example

| <i>Engagement 1 through 5 – Day, Prone, Unsupported</i> | | | |
|---|---------------------------|---|-----------------------|
| | Engagement | Target | Target Type |
| | 1 through 5 | E-1 F-1 | Point |
| | Rounds | DODIC | Time (Seconds) |
| | 1 MAG x 10 1 BELT x 50 | AB57 AB73 | 56 |
| TOWER | | SOLDIER ACTION | |
| WEAPONS SAFETY STATUS RED | | MAKE READY | |
| ALERT | | CONTACT | |
| TARGET DESCRIPTION | | TROOPS | |
| DIRECTION | | FRONT | |
| RANGE | | MID-RANGE | |
| METHOD | | NEAR TO FAR | |
| CONTROL | | WEAPONS FREE WEAPONS FREE | |
| EXECUTION | | ENGAGE UPON POSITIVE IDENTIFICATION | |
| | | Soldier moves the weapon from SAFE to FIRE, and begins the target acquisition process. | |
| | | Soldier engages the first target from the STANDING UNSUPPORTED firing position then goes to the PRONE UNSUPPORTED firing position. Soldier acquires, prioritizes, and engages targets with one round or killing burst per target. | |
| TOWER AWAITS COMPLETION OF ENGAGEMENT 5 THEN PROCEEDS IMMEDIATELY | | | |
| WEAPONS SAFETY STATUS REMAINS RED | | | |
| <p>Note: There is a 5-second delay between the first and second engagement to allow the Soldier to go to prone. There is a 2-second delay between all other engagements in this table. There is an 8-second delay at the end of the phase to support changing ammunition and changing the firing position.</p> | | | |
| <p>Legend: DODIC – Department of Defense identification code, MAG – magazine</p> | | | |

Table I-43. Table V, engagement 6 through 10, conduct of fire example

| <i>Engagement 6 through 10 – Day, Prone, Supported</i> | | | |
|--|---|--|--|
| | Engagement | Target | Target Type |
| | 6 through 10 | E-1 | Point |
| | Rounds | DODIC | Time (Seconds) |
| | 1 MAG x 10 1 BELT x 50 | AB57 AB73 | 46 |
| TOWER | | SOLDIER ACTION | |
| WEAPONS SAFETY STATUS RED | <i>Although the firer's bolt should be locked to the rear, the tower must treat all weapons as if in a RED status</i> | | Soldier remains in the PRONE position, at the READY and may RELOAD or await instructions. |
| CONTROL | GO TO PRONE SUPPORTED RELOAD | The Soldier conducts an emergency RELOAD and establishes a PRONE, SUPPORTED position and prepares to engage. | |
| TOWER AWAITS THE END OF THE 8-SECOND TRANSITION THEN PROCEEDS | | | |
| WEAPONS SAFETY STATUS REMAINS RED | | | |
| EXECUTION | ENGAGE UPON POSITIVE IDENTIFICATION | Soldier acquires, prioritizes, and engages targets with one round or killing burst per target. | |
| TOWER AWAITS COMPLETION OF ENGAGEMENT 10 THEN PROCEEDS IMMEDIATELY | | | |
| WEAPONS SAFETY STATUS REMAINS RED | | | |
| <p>Note: There is a 2-second delay between all engagements. There is an 8-second delay at the end of the phase to support changing ammunition and changing the firing position.</p> | | | |
| <p>Legend: DODIC – Department of Defense identification code, MAG – magazine</p> | | | |

Table I-44. Table V, engagement 11 through 14, conduct of fire example

| <i>Engagement 11 through 14 – Kneeling, Supported</i> | | | |
|---|--|---|---|
| | Engagement | Target | Target Type |
| | 11 through 14 | E-1 F-1 | Point |
| | Rounds | DODIC | Time (Seconds) |
| | 1 MAG x 10 2 MAG x 25 | AB57 | 48 |
| TOWER | | SOLDIER ACTION | |
| WEAPONS SAFETY STATUS RED | <i>Although the firer's bolt should be locked to the rear, the tower must treat all weapons as if in a RED status.</i> | | Soldier remains at the READY and may RELOAD or await instructions. |
| CONTROL | RELOAD FIGHT UP | The Soldier conducts an emergency RELOAD and assumes the KNEELING, SUPPORTED position. | |
| TOWER AWAITS THE END OF THE 8-SECOND TRANSITION THEN PROCEEDS | | | |
| WEAPONS SAFETY STATUS REMAINS RED | | | |
| EXECUTION | ENGAGE UPON POSITIVE IDENTIFICATION | Soldier acquires, prioritizes, and engages targets with one round or killing burst per target. M249AR Firers must conduct an emergency reload without instruction from the tower. | |
| TOWER AWAITS COMPLETION OF ENGAGEMENT 14 THEN PROCEEDS | | | |
| WEAPONS SAFETY STATUS REMAINS RED | | | |
| Note: There is a 2-second delay between all engagements. There is an 8-second delay at the end of the phase to support changing ammunition and changing the firing position. | | | |
| Legend: DODIC – Department of Defense identification code, MAG – magazine | | | |

Table I-45. Table V, engagement 15 through 18, conduct of fire example

| <i>Engagement 15 through 18 – Standing, Supported</i> | | | |
|--|--|--|--|
| | Engagement | Target | Target Type |
| | 15 through 18 | E-1 F-1 | Point |
| | Rounds | DODIC | Time (Seconds) |
| | 1 MAG x 10 1 BELT x 50 | AB57 AB73 | 40 |
| TOWER | | SOLDIER ACTION | |
| WEAPONS SAFETY STATUS RED | <i>Although the firer's bolt should be locked to the rear, the tower must treat all weapons as if in a RED status.</i> | | Soldier remains at the READY and may RELOAD or await instructions. |
| CONTROL | RELOAD FIGHT UP | The Soldier conducts an emergency RELOAD and assumes the STANDING, SUPPORTED position. | |
| TOWER AWAITS THE END OF THE 8-SECOND TRANSITION THEN PROCEEDS | | | |
| WEAPONS SAFETY STATUS REMAINS RED | | | |
| EXECUTION | ENGAGE UPON POSITIVE IDENTIFICATION | | Soldier acquires, prioritizes, and engages targets with one round per target. |
| TOWER AWAITS COMPLETION OF ENGAGEMENT 18 THEN PROCEEDS | | | |
| WEAPONS SAFETY STATUS REMAINS RED | | | |
| <p>Note: There is a 2-second delay between all engagements. There is a 60-second delay at the end of the phase to support the donning of protective equipment, M249AR barrel change, and reloading.</p> | | | |
| <p>Legend: DODIC – Department of Defense identification code, MAG – magazine</p> | | | |

Table I-46. Table V, stage 2, conduct of fire example









| Stage 2, Conduct of the Range | | | |
|---|--|---|----------------|
|     CBRN | Engagement | Target | Target Type |
| | Stage 2 | N/A | N/A |
| | Rounds per Target | DODIC | Time (Seconds) |
| | N/A | AB57 AB73 | 60 Seconds |
| TOWER | | SOLDIER ACTION | |
| CONDUCT OF THE RANGE FIRERS, CHEMICAL AGENTS HAVE BEEN REPORTED IN YOUR AREA GAS GAS GAS |     | Soldiers don their protective equipment. | |
| ONCE ALL FIRERS HAVE COMPLETED DONNING PROTECTIVE GEAR, THE TOWER CONTINUES. | | | |
| WEAPONS SAFETY STATUS RED | <i>Although the firer's bolt should be locked to the rear, the tower must treat all weapons as if in a RED status.</i> | Soldier remains at the READY and may RELOAD or await instructions. | |
| CONTROL | BARREL CHANGE RELOAD | M249AR firers change barrels and all Soldiers conduct an emergency RELOAD and assume the STANDING, SUPPORTED position. | |
| TOWER AWAITS THE END OF THE 60-SECONDS THEN PROCEEDS | | | |
| Legend: M249AR – automatic rifle, CBRN – chemical, biological, radiological, and nuclear, DODIC – Department of Defense identification code, N/A – not applicable | | | |

Table I-47. Table V, engagement 19 through 22, conduct of fire example

| <i>Engagement 19 through 22 – Standing, Supported</i> | | | |
|---|-------------------------------------|--|-----------------------|
| | Engagement | Target | Target Type |
| | 19 through 22 | E-1 F-1 | Point |
| | Rounds | DODIC | Time (Seconds) |
| | 1 MAG x 10 1 BELT x 50 | AB57 AB73 | 40 |
| TOWER | | SOLDIER ACTION | |
| WEAPONS SAFETY STATUS REMAINS RED | | | |
| CONTROL | CONTINUE TO FIGHT | Assumes the STANDING, SUPPORTED position. | |
| WEAPONS SAFETY STATUS REMAINS RED | | | |
| EXECUTION | ENGAGE UPON POSITIVE IDENTIFICATION | Soldier acquires, prioritizes, and engages targets with one round or killing burst per target. | |
| TOWER AWAITS COMPLETION OF ENGAGEMENT 18 THEN PROCEEDS | | | |
| WEAPONS SAFETY STATUS REMAINS RED | | | |
| <p>Note: There is a 2-second delay between all engagements. This completes the live firing phase for Table V. There are no alibis authorized. Any remaining ammunition is returned to the ammunition issue point for redistribution.</p> | | | |
| <p>Legend: DODIC – Department of Defense identification code, MAG – magazine</p> | | | |

I-72. A lane safety clears the firers upon their completion of Table V and collecting their dunnage. A lane safety verifies the clearing prior to the Soldier moving from the firing point. Once the lane safety clears all the Soldiers, the lane safety communicates the WSS to the tower operator and the tower operator issues an administrative command moving the completed Soldiers off the range. Table I-48, on page I-54, is an example of this command.

Table I-48. Table V, completed firing order, conduct of the range example

| <i>Firing Order Complete</i> | | | |
|--|--|---|----------------|
| FIRING ORDER COMPLETE | Task | Target | Target Type |
| | Completed Firing Order | N/A | N/A |
| | Rounds per Target | DODIC | Time (Seconds) |
| | N/A | N/A | NO LIMIT |
| TOWER | | SOLDIER ACTION | |
| TOWER MUST ASSUME ALL FIRERS' WEAPON SAFETY STATUS IS RED | | | |
| TERMINATION | CEASE FIRE CEASE FIRE | Soldiers stop firing and place weapons on SAFE. | |
| WEAPONS SAFETY STATUS GREEN | GO GREEN GO GREEN ONCE VERIFIED BY THE RSO, SECURE WEAPON | Soldiers clear their weapon and wait to be inspected by a lane safety. | |
| CONDUCT OF THE RANGE | ALL CLEAR ALL CLEAR SECURE YOUR DUNNAGE MOVE TO THE ENTRY CONTROL POINT | Firers unmask, secure their weapon, ammunition and dunnage. Once complete, they move to the range's entry control point. | |
| ONCE ALL FIRERS RETURN TO THE BASELINE, TOWER DIRECTS THE FIRING ORDER OFF THE RANGE. | | | |
| Legend: DODIC – Department of Defense identification code, N/A – not applicable, RSO – range safety officer | | | |

I-73. As soon as the lane safety clears the completed firing order, the tower operator moves a new firing order into position and the process repeats itself until all firers have completed Table V, Practice, successfully. Any identified firers that require retraining move to the appropriate concurrent training location.

ASSISTED NIGHT FIRE, TABLE VI, CERTIFICATION

I-74. Table VI, Certification is an evaluation table used to demonstrate the firer's proficiency at common engagement and tactical skills. Table VI tasks challenge firers with single and multiple stationary targets between 50- and 300-meters, from the prone unsupported, prone supported, kneeling supported, and standing supported firing positions. The purpose of Table VI is to train the firer to use their limited visibility-aiming device to engage single and multiple targets placed in a tactical array and to apply the functional elements of the shot process. In a timed scenario, the firer demonstrates target prioritization and weapons manipulation in a limited visibility environment. Table VI tasks occur on an ARF or comparable range facility.

TASK, CONDITIONS, AND STANDARD

I-75. Table I-49 outlines the task, conditions, and standard for conducting the Table VI task. The firer conducting the event should know the task, conditions, and standard and should explain them during the conduct of the range briefing.

Table I-49. Assisted night fire, Table VI, Certification task, conditions, and standard

| | |
|---|--|
| Task: | Engage and defeat single and multiple threats at varying ranges from supported or unsupported standing, kneeling, and prone firing positions, during limited visibility and simulated chemical environment conditions using ball ammunition. |
| Conditions: | Given the following: <ul style="list-style-type: none"> • Fully mission capable weapon as assigned on the master authorization list for the unit. • Full combat uniform, issued equipment, and protective mask. • Authorized range facility. • Authorized simulator system (Day Fire, CBRN; Night Fire; and Night Fire, CBRN). • Full-scale, approved targetry in standard scenario engagement sequences. • Authorized ammunition. |
| Standard: | Demonstrate engagement proficiency by hitting 70 percent (35 of 50) of all presented targets in the time allotted. |
| Legend: CBRN – chemical, biological, radiological, and nuclear | |

I-76. Table I-50, on page 1-56, shows the training event design template for Assisted Night Fire, Table VI, Certification. Leaders conduct this event on an authorized live-fire facility, typically an ARF or comparable range facility. See TC 25-8 for additional information on authorized range facilities.

Table I-50. Training event design template for assisted night fire, Table VI, Certification

| <i>Assisted Night Fire, Table VI, Certification Live-Fire Proficiency Gate</i> | | | | | | | |
|--|--------------------------|-----------------------|----------------------|---------------------------------|-----------------------|---------------------------|----------|
| EVENT NAME: | CERTIFICATION | ENVIRONMENT: | | LIVE | 1.0 | | |
| WEAPON: | M4 / M16 / M249AR | CONDITIONS: | | LIVE FIRE | | | |
| CATEGORY: | CERTIFICATION | PRIMARY FACILITY: | | ARF | DAYS REQUIRED | | |
| PUBLICATION: | TC 3-22.9 TC 3-22.249 | ALTERNATE FACILITY: | | QTR | | | |
| REQUIRED: | YES | COMPONENT: | AC | RC | 120 SOLDIERS | | |
| RECORD: | DA Form 7489 | FREQUENCY: | 2 | 1 | | | |
| VALID FOR: | 12 MONTHS | ANNUAL DAYS TOTAL: | 2 | 1 | THROUGHPUT | | |
| TABLE | | | | | | | |
| | | I | II | III | IV | V | VI |
| | | PMI&E | PLFS | DRILLS | BASIC | PRACTICE | CERT |
| | | PRQ | PRQ | PRQ | | | REQUIRED |
| WHEN EXECUTED: | | | | | | | T-X |
| CONDEMNATION CRITERIA (CC) | RULE 1 | RULE 2 | RULE 3 | RULE 4 | RULE 5 | RULE 6 | |
| | TIME | KEY LEADER TURNOVER | COMMANDER ASSESSMENT | SUBORDINATE ELEMENT PROFICIENCY | SPECIALTY PROFICIENCY | STAFF SECTION PROFICIENCY | |
| <p>Remarks: Each Soldier assigned a limited visibility aiming device <i>must</i> successfully complete Table VI, Certification. The Assisted Night Fire Certification is required for any Soldier to participate in <i>any limited visibility collective live-fire event that incorporates the use of these devices</i>.</p> | | | | | | | |
| <p>Note: Table III should be used as concurrent training on Tables IV, V, and VI while Soldiers are awaiting training in a firing order or between day and night phases.</p> | | | | | | | |
| <p>Legend: AC – active component (known as active duty), ARF – automated record fire range, AR – automatic rifle, CERT – certification, DA – Department of the Army, PRQ – prerequisite, PLFS – preliminary live-fire simulation, PMI&E – preliminary marksmanship instruction and evaluation, QTR – qualification training range, RC – Reserve Component (known as Reserves), TC – training circular, T-X – training event exercise, TNG DAYS TO CERT – number of training days remaining on the critical path to weapon’s certification</p> | | | | | | | |

I-77. Due to the varying training environments required to certify the capabilities of the weapon and to enable the Soldier to demonstrate proficiency effectively, leaders conduct this course of fire in stages. Leaders conduct all stages as live-fire scenarios during certification. The stages are conditions-based as described in table I-51.

Table I-51. Stage descriptions, assisted night fire, Table VI, Certification

| Stage | Conditions | Remarks |
|--|---------------------------|---|
| Stage 1 | Assisted Night Fire | Includes all pointers, illuminators, lasers, and thermal weapons sight. |
| Stage 2 | Assisted Night Fire, CBRN | Completed after Stage 1. |
| <p>Legend: CBRN – chemical, biological, radiological, and nuclear</p> | | |

AMMUNITION

I-78. All Soldiers assigned a limited visibility aiming device for use with a rifle, carbine, or automatic rifle on a unit MAL must complete Assisted Night Fire, Table VI, Certification. This event is conducted to demonstrate the Soldier's proficiency to employ a rifle and carbine against mid-range threats during limited visibility condition and in a simulated chemical environment.

I-79. To effectively plan and forecast for sufficient training ammunition, the unit uses the ammunition requirements listed in table I-52. Units need to identify the total number of firers and should plan for unscheduled firers and necessary retraining by increasing their forecasted training.

Table I-52. Assisted night fire, Table VI, Certification ammunition requirements

| Training Event | DODIC | Nomenclature | Quantity | Remarks |
|---|-------|--|----------|--|
| All Weapons | | | | |
| Table IV, Stage 3, Confirmation at Distance | AB57 | CTG, 5.56mm, ball, M855A1 EPR | 5 | Conducted prior to Table V on the ARF or comparable facility when range restrictions or line-of-sight issues prevent completion of the task during Table IV. |
| Table IV, Stage 4 Application of Hold-Offs | AB57 | CTG, 5.56mm, ball, M855A1 EPR | 10 | Conducted prior to Table V on the ARF or comparable facility when range restrictions or line-of-sight issues prevent completion of the task during Table IV. |
| M4 / M16 | | | | |
| Table VI, Stage 1, Certification | AB57 | CTG, 5.56mm, ball, M855A1 EPR | 40 | One round per target is required. |
| Table VI, Stage 2, Certification | AB57 | CTG, 5.56mm, ball, M855A1 EPR | 10 | One round per target is required. |
| M249AR | | | | |
| Table VI, Stage 1, Certification | AB73 | CTG, 5.56mm linked (4:1) M855A1 (ball) and M856A1 (tracer) | 200 | 3 to 5 round burst per target is required. |
| Table VI, Stage 2, Certification | AB73 | CTG, 5.56mm linked (4:1) M855A1 (ball) and M856A1 (tracer) | 50 | 3 to 5 round burst per target is required. |
| Legend: ARF – automated record fire range, AR – automatic rifle, CTG – cartridge, DODIC – Department of Defense identification code, EPR – enhanced performance round, mm – millimeter | | | | |

I-80. Table VI tasks are automated, timed events that consists of five live-fire phases. Stage 1 consists of the first four phases followed by fifth stage, which comprises stage 2. The leaders issue every firer ammunition as shown in table I-53, on page I-58, to conduct the event to standard. Firers place ammunition in their ammunition pouches. Staging or pre-positioning ammunition is not authorized for the conduct of Table VI training.

Table I-53. Assisted night fire, Table VI, Certification ammunition breakdown

| <i>Phase</i> | <i>Sequence</i> | <i>M4 / M16</i> | <i>M249AR</i> |
|--|-----------------|---|--|
| | | <i>AB57 5.56mm, Ball Single Round</i> | <i>AB73 5.56mm, Ball, Linked</i> |
| Stage 1 | | | |
| Prone, Unsupported | 1 | 10 each | 50 round belt |
| Prone, Supported | 2 | 10 each | 50 round belt |
| Kneeling, Supported | 3 | 10 each | 50 round belt |
| Standing, Supported | 4 | 10 each | 50 round belt |
| Stage 2 | | | |
| Standing Supported, CBRN | 5 | 10 each | 50 round belt |
| Legend: M249AR – automatic rifle, CBRN – chemical, biological, radiological, and nuclear, mm – millimeter | | | |

RANGE FACILITIES

I-81. Table I-54 shows the Army-standard range facilities designed to support Assisted Night Fire, Table VI, Certification event. Units must refer to their installation’s range operations SOPs or local training regulations to identify the weapon specific range facilities. Units use their RFMSS system for all scheduling.

Table I-54. Assisted night fire, Table VI, Certification authorized range facilities

| Table VI | Targetry | Range Facility | |
|---|---|----------------|-----|
| | | ARF | QTR |
| Certification | E-type, E1, target, silhouette: plastic, polyethylene, kneeling (NSN: 6920-00-071-4780) F-type, F-1, target, silhouette: plastic, polyethylene, prone (NSN 6920-00-071-4589) | P | A |
| | D-type, D1, target, silhouette: plastic, mannequin, kneeling (NSN 6920-01-164-9625) D-type, D-2, target, 3-dimensional: plastic, mannequin, prone (NSN 6920-01-387-6397) | P | A |
| Legend: A – alternate, ARF- automated record fire range, NSN – national stock number, P – primary, QTR – qualification training range | | | |

TARGETRY

I-82. Table VI requires silhouette targetry, either E-type, F-type, or D-type targets on the range. The leader must confirm the type and capability of the targetry, lifting mechanisms, and simulators on the range and identify any unit requirements. During the preparation phase, leaders should be familiar with the targetry used and the sequence of the firing events. Figure I-4, on page I-60, shows the authorized targetry used during the Table VI event.





| | |
|--|--|
| <p>E-1 <i>Target, silhouette: plastic, polyethylene, kneeling</i> NSN 6920-00-071-4780</p> | <p>D-1 <i>Target, 3-dimensional: plastic, mannequin, kneeling</i> NSN 6920-01-164-9625</p> |
|  |  |
| <p>F-1 <i>Target, silhouette: plastic, polyethylene, prone</i> NSN 6920-00-071-4589</p> | <p>D-2 <i>Target, 3-dimensional: plastic, mannequin, prone</i> NSN 6920-01-387-6397</p> |
|  <p>Prone targets are only used on the 50-meter RIGHT emplacement.</p> |  <p>Prone targets are only used on the 50-meter RIGHT emplacement.</p> |
| <p>Notes:</p> <p>Use of E-1 or D-1 kneeling targets is at the discretion of the installation. Both represent dismounted, kneeling Infantry targets on small arms and maneuver facilities.</p> <p>Use F-1 or D-2 on the RIGHT 50-meter target emplacement only.</p> <p>Use of G-2 prone targets is not authorized.</p> | |
| <p>Legend: NSN – national stock number</p> | |

Figure I-4. Table VI, authorized target types

SCENARIO ENGAGEMENTS

I-83. Targets are presented to the firer in single and multiple target arrays. Targets are presented such that 90-percent of the target is clearly visible to the firer from the expected or planned firing position. Targets are exposed to the firer based on the number of targets presented during the engagement:

- Single target engagements are exposed for 5 seconds.
- Double target engagements are exposed for 8 seconds.
- Triple target engagements are exposed for 12 seconds.
- Quadruple target engagements are exposed for 16 seconds.

I-84. There is a 3-second delay between each engagement. After each phase (prone unsupported, prone supported, kneeling supported, and standing supported), there is a 10-second transition delay giving the firer time to conduct an emergency reload and to assume the next specified position. There is a 60-second transition delay between stage 1 and stage 2 to allow firers to don protective equipment, change the M249 automatic rifle barrel, and reload. Table I-55 shows the scenario engagement sequence for Table VI engagements.

Table I-55. Assisted night fire Table VI, Certification, stage 1, engagement sequence

| <i>Table VI, Certification, Engagements 1 through 5, React to Contact, Transition to Prone, Unsupported</i> | | | |
|---|--------------------|---------------|----------------------|
| <i>Engagement</i> | <i>Target Type</i> | <i>Range</i> | <i>Exposure Time</i> |
| 1 | F-type | 50 m RIGHT | 5 sec |
| 2 | E-type | 100 m | 5 sec |
| 3 | E-type | 150 m | 5 sec |
| 4 | E-type | 50 m LEFT | 12 sec |
| | E-type | 150 m | |
| | E-type | 200 m | |
| 5 | E-type | 150 m | 16 sec |
| | E-type | 200 m | |
| | E-type | 250 m | |
| | E-type | 300 m | |
| Prone, Unsupported, Time per Firing Order Total | | | 67 sec |
| Note: There is a 5-second delay between the first and second engagement to allow the Soldier to go to prone. There is a 3-second delay between all other engagements in this table. A 10-second delay time is incorporated at the end of engagement 5 to facilitate reloading and firing position changes. | | | |

Table I-55. Assisted night fire, Table VI, Certification, stage 1, engagement sequence (continued)

| <i>Table VI, Certification, Engagements 6 through 10, Prone, Supported</i> | | | |
|--|--------------------|--------------|----------------------|
| <i>Engagement</i> | <i>Target Type</i> | <i>Range</i> | <i>Exposure Time</i> |
| 6 | E-type | 100 m | 5 sec |
| 7 | E-type | 150 m | 8 sec |
| | E-type | 300 m | |
| 8 | E-type | 200 m | 8 sec |
| | E-type | 300 m | |
| 9 | E-type | 250 m | 8 sec |
| | E-type | 300 m | |
| 10 | E-type | 150 m | 12 sec |
| | E-type | 250 m | |
| | E-type | 300 m | |
| Prone, Supported, Time per Firing Order Total | | | 63 sec |
| <p>Note: There is a 3-second delay between all engagements. A 10-second delay time is incorporated at the end of engagement 10 to facilitate reloading and firing position changes.</p> | | | |

Table I-55. Assisted night fire, Table VI, Certification, engagement sequence (continued)

| <i>Table VI, Certification, Engagements 11 through 14, Kneeling, Supported</i> | | | |
|---|--------------------|---------------|----------------------|
| Engagement | Target Type | Range | Exposure Time |
| 11 | E-type | 50 m LEFT | 12 sec |
| | E-type | 100 m | |
| | E-type | 200 m | |
| 12 | F-type | 50 m RIGHT | 8 sec |
| | E-type | 200 m | |
| 13 | E-type | 150 m | 8 sec |
| | E-type | 250 m | |
| 14 | E-type | 100 m | 12 sec |
| | E-type | 150 m | |
| | E-type | 200 m | |
| Kneeling, Supported, Time per Firing Order Total | | | 59 sec |
| Note: There is a 3-second delay between all engagements. A 10-second delay time is incorporated at the end of engagement 14 to facilitate reloading and firing position changes. | | | |

Table I-55. Assisted night fire, Table VI, Certification, engagement sequence (continued)

| <i>Table VI, Certification, Engagements 15 through 18, Standing, Supported</i> | | | |
|--|--------------------|---------------|----------------------|
| <i>Engagement</i> | <i>Target Type</i> | <i>Range</i> | <i>Exposure Time</i> |
| 15 | E-type | 50 m LEFT | 8 sec |
| | E-type | 100 m | |
| 16 | E-type | 200 m | 8 sec |
| | E-type | 250 m | |
| 17 | F-type | 50 m RIGHT | 12 sec |
| | E-type | 100 m | |
| | E-type | 150 m | |
| 18 | E-type | 100 m | 12 sec |
| | E-type | 200 m | |
| | E-type | 250 m | |
| Standing, Supported, Time per Firing Order Total | | | 109 sec |
| <p>Note: There is a 3-second delay between all engagements. A 60-second delay time is incorporated at the end of engagement 18 to facilitate the donning of protective equipment, M249 automatic rifle barrel change and reloading.</p> | | | |

Table I-55. Assisted night fire, Table VI, Certification, engagement sequence (continued)

| <i>Table VI, Certification, Engagements 19 through 22, Standing, Supported, CBRN</i> | | | |
|--|--------------------|---------------|----------------------|
| <i>Engagement</i> | <i>Target Type</i> | <i>Range</i> | <i>Exposure Time</i> |
| 19 | E-type | 50 m LEFT | 8 sec |
| | E-type | 100 m | |
| 20 | E-type | 200 m | 8 sec |
| | E-type | 250 m | |
| 21 | F-type | 50 m RIGHT | 12 sec |
| | E-type | 100 m | |
| | E-type | 150 m | |
| 22 | E-type | 100 m | 12 sec |
| | E-type | 250 m | |
| | E-type | 300 m | |
| Standing, Supported, Time per Firing Order Total | | | 49 sec |
| Note: There is a 3-second delay between all engagements. | | | |
| Legend: m – meters; sec – seconds; CBRN – chemical, biological, radiological, nuclear | | | |

I-85. Throughput schedules are a guide for units and portray the overall efficiency of the range facility when conducting the training event. Throughput schedules provide the overall throughput timetable, based on the time the unit requires to remove one firing order from the firing positions and move the next firing order forward. Table I-56, on page I-66, provides the Table VI, Certification throughput schedule.

I-86. Three general movement schedules are available to administer firing order placements on the range, 2 minutes, 5 minutes, and 10 minutes. The more proficient a unit is at operating a small arms range facility, the greater the firer throughput on the facility. This schedule does not include time required for retraining, refire, or firers who have persistent problems using a reticle.

Table I-56. Assisted night fire, Table VI, Certification throughput time schedule

| <i>Phase</i> | <i>Time to Execute</i> | <i>Remarks</i> | | | |
|--|--|---|---------------|--|----------------|
| Prone, Unsupported | 1:07 minute | Includes 3-seconds between engagements and 10-seconds transition to next phase. | | | |
| Prone, Supported | 1:03 minute | | | | |
| Kneeling, Supported | 0:59 seconds | | | | |
| Standing, Supported | 1:49 seconds | Includes 60-seconds between stages. | | | |
| Standing, Supported CBRN | 0:49 | Includes 3-seconds between engagements. | | | |
| Total Time Per Firing Order | 5:47 minutes | Does not include administrative time to move firing order to or from their respective firing positions. | | | |
| <i>Total Number of Firing Orders</i> | <i>Table VI Execution with Administration Time Between Firing Orders</i> | | | <i>Total Firer Throughput based on Range Configuration</i> | |
| | <i>2 min</i> | <i>5 min</i> | <i>10 min</i> | <i>16 Lane</i> | <i>32 Lane</i> |
| 2 | 16 min | 22 min | 32 min | 32 | 64 |
| 3 | 23 min | 32 min | 47 min | 48 | 96 |
| 4 | 31 min | 43 min | 1 hr 3 min | 64 | 128 |
| 5 | 39 min | 54 min | 1 hr 19 min | 80 | 160 |
| 6 | 47 min | 1 hr 5 min | 1 hr 35 min | 96 | 192 |
| 7 | 54 min | 1 hr 15 min | 1 hr 50 min | 112 | 224 |
| 8 | 1 hr 2 min | 1 hr 26 min | 2 hrs 6 min | 128 | 256 |
| 9 | 1 hr 10 min | 1 hr 37 min | 2 hrs 22 min | 144 | 288 |
| 10 | 1 hr 18 min | 1 hr 48 min | 2 hrs 38 min | 160 | 320 |
| 11 | 1 hr 26 min | 1 hr 59 min | 2 hrs 54 min | 176 | 352 |
| 12 | 1 hr 33 min | 2 hrs 9 min | 3 hrs 9 min | 192 | 384 |
| 13 | 1 hr 41 min | 2 hrs 20 min | 3 hrs 25 min | 208 | 416 |
| 14 | 1 hr 49 min | 2 hrs 31 min | 3 hrs 41 min | 224 | 448 |
| 15 | 1 hr 57 min | 2 hrs 42 min | 3 hrs 57 min | 240 | 480 |
| 16 | 2 hrs 5 min | 2 hrs 53 min | 4 hrs 13 min | 256 | 512 |
| 17 | 2 hrs 12 min | 3 hrs 3 min | 4 hrs 28 min | 272 | 544 |
| 18 | 2 hrs 20 min | 3 hrs 14 min | 4 hrs 44 min | 288 | 576 |
| 19 | 2 hrs 28 min | 3 hrs 25 min | 4 hrs 60 min | 304 | 608 |
| 20 | 2 hrs 36 min | 3 hrs 36 min | 5 hrs 16 min | 320 | 640 |
| Legend: CBRN – chemical, biological, radiological, and nuclear, hr – hour; hrs – hours, min – minutes | | | | | |

CONDUCT OF THE RANGE

I-87. Leaders instruct Soldiers on the objectives of Table VI tasks and the importance of the functional elements of the shot process. Table VI contains 22 firing tasks with an administrative pause programmed at the end of each phase to facilitate emergency reloading and changing positions.

I-88. Soldiers enter the range and move to their firing points. Once at the firing point, firers assume a standing firing position with rifle and carbines in a green status. Firers fire Table VI tasks from the ready at varying firing positions throughout the duration of the course of fire, where—

- Tasks 1 through 5 are fired from the prone, unsupported firing position.
- Tasks 6 through 10 are fired from the prone, supported firing position.
- Tasks 11 through 14 are fired from the kneeling, supported firing position.
- Tasks 15 through 18 are fired from the standing, supported firing position.
- Tasks 19 through 22 are fired from the standing, supported firing position in a simulated chemical environment.

I-89. Firers must hit a minimum of 35 of the 50 targets presented (70 percent) to successfully pass this event. The leader annotates the official record of training DA Form 7489.

I-90. Soldiers begin Table VI tasks by moving into the firing position following administrative commands from the tower operator. Tower operators use administrative commands to control the flow of the range, movement of personnel, and other command and control purposes. Table I-57 provides an example of the administrative commands for moving a new firing order into position.

Table I-57. Table VI, new firing order, conduct of the range example

| <i>New Firing Order, Conduct of the Range</i> | | | |
|--|---|--|-----------------------|
| | Task | Target | Target Type |
| PRACTICE | New Firing Order | N/A | N/A |
| | Rounds per Target | DODIC | Time (Seconds) |
| | N/A | AB57 AB73 | NO LIMIT |
| TOWER | SOLDIER ACTION | | |
| CONDUCT OF THE RANGE | SECURE YOUR AMMUNITION AND MOVE TO YOUR FIRING POINT | Soldiers secure their weapon in a GREEN status, their training ammunition and move to the designated firing point. | |
| ONCE ALL FIRERS ARE COMPLETE, CONDUCT OF THE RANGE CONTINUES. | | | |
| Legend: DODIC – Department of Defense identification code, N/A – not applicable | | | |

I-91. If the unit cannot complete stages 3 and 4 during the Table IV event, the unit must provide three five-round magazines to each firer (M249 automatic rifle firers receive five one-round magazines and 10 additional rounds). The firing order conducts both tasks prior to beginning the Table VI event.

I-92. Units can use the following guide (table I-58, on page I-68) to complete stages 3 and 4 of Table IV. Firers are in a green status at their assigned firing point.

Table I-58. Table IV, engagement 7, confirmation at distance, conduct of fire example

| <i>Table IV, Engagement 7 – Zero Confirmation at Distance</i> | | | |
|---|--|---|-------------------------------------|
|  <p>300 meter (Unit may select different zero range based on their SOP, TTP, or mission requirements).</p> | Zero Confirmation | Target | Target Type |
| | 1 | E-1 or D-1 | Silhouette, kneeling (hit-bob mode) |
| | Rounds per Engagement | DODIC | Time (Seconds) |
| | 5 | AB57 | NO LIMIT |
| TOWER | | SOLDIER ACTION | |
| WEAPONS SAFETY STATUS RED | GO TO PRONE MAKE READY | Soldier moves to the PRONE supported position, establishes a good firing position, and loads a magazine. | |
| ALERT | FIRERS | | |
| TARGET DESCRIPTION | TROOP | Soldier acquires the zero confirmation target. | |
| DIRECTION | FRONT | | |
| RANGE | THREE-HUNDRED | Soldier acquires the target and identifies the target's center of visible mass (known as CoVM). | |
| CONTROL | FIVE ROUNDS SLOW FIRE WEAPONS FREE WEAPONS FREE | | |
| EXECUTION | ENGAGE UPON POSITIVE IDENTIFICATION | Soldier begins slow firing a five-round shot group, ensuring the same point of aim for each round. | |
| ONCE ALL FIRERS ARE COMPLETE WITH THE FIVE-ROUND CONFIRMATION AT DISTANCE: | | | |
| TERMINATION | CEASE FIRE CEASE FIRE | The firer's BOLT should be locked to the rear. Tower must assume all weapons are RED. | |
| WEAPONS SAFETY STATUS GREEN | GO GREEN SHOW CLEAR | Soldiers clear their weapons, show clear to the lane safety. | |
| Firer's should achieve four of five hits to successfully complete confirmation at distance. The tower should identify any firer that has not met the confirmation standard and move those Soldiers to the retraining location. | | | |
| Legend: DODIC – Department of Defense identification code, SOP – standard operating procedure, TTP – tactics, techniques, and procedures | | | |

I-93. Once all firers have completed stage 3, they remain in place and await further instructions from the tower operator. The tower operator instructs them to reload and prepare for stage 4. Table I-59 shows an example of the conduct of fire for Table IV, Stage 4.

Table I-59. Table IV, engagement 8, application of hold-offs, conduct of fire example

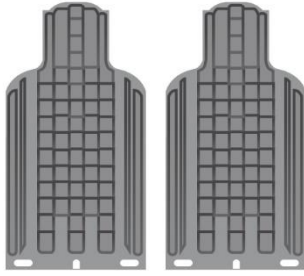
| <i>Table IV, Engagement 8 – Application of Hold-Offs</i> | | | |
|---|--|--|-------------------------------------|
|  <p>100 and 200 meter</p> | Application of Hold-Offs | Target | Target Type |
| | 1 | E-1 or D-1 | Silhouette, kneeling (hit-bob mode) |
| | Rounds per Engagement | DODIC | Time (Seconds) |
| | 10 | AB57 | 55 |
| TOWER | | SOLDIER ACTION | |
| WEAPONS SAFETY STATUS RED | MAKE READY | Soldier remains in the PRONE supported position, establishes a good firing position, and loads one 10-round magazine. | |
| ALERT | FIRERS | | |
| TARGET DESCRIPTION | TROOPS | Soldier acquires the 100 meter target. | |
| DIRECTION | FRONT | | |
| RANGE | ONE-HUNDRED AND TWO HUNDRED | Soldier acquires the target and identifies the target's center of visible mass (known as CoVM). | |
| CONTROL | FIVE ROUNDS SLOW FIRE WEAPONS FREE WEAPONS FREE | | |
| EXECUTION | ENGAGE UPON POSITIVE IDENTIFICATION | Soldier begins slow firing a five-round shot group, applying the appropriate hold-off at the 100 meter target and again at the 200 meter target. | |
| ONCE ALL FIRERS ARE COMPLETE WITH THE 10-ROUND APPLICATION OF HOLD-OFF: | | | |
| TERMINATION | CEASE FIRE CEASE FIRE | The firer's BOLT should be locked to the rear. Tower must assume all weapons are RED. | |
| WEAPONS SAFETY STATUS GREEN | GO GREEN SHOW CLEAR | Soldiers clear their weapons, show clear to the lane safety. | |
| Firer's should achieve four of five hits on each target to successfully complete application of hold-offs. The tower should identify any firer that has not met the standard and move those Soldiers to the retraining location. | | | |
| Legend: DODIC – Department of Defense identification code, SOP – standard operating procedure, TTP – tactics, techniques, and procedures, | | | |

I-94. The following engagement sequence guide initiates the Table VI scenario. The engagement sequence with a generic conduct of fire process for the tower is provided in tables I-60 through I-65, on pages I-71 through I-75.

Table I-60. Table VI, engagement 1 through 5, conduct of fire example

| <i>Engagement 1 through 5 – Prone, Unsupported</i> | | | |
|---|--|---|-----------------------|
| | Engagement | Target | Target Type |
| | 1 through 5 | E-1 F-1 | Point |
| | Rounds | DODIC | Time (Seconds) |
| | 1 MAG x 10 1 BELT x 50 | AB57 AB73 | 67 |
| TOWER | | SOLDIER ACTION | |
| WEAPONS SAFETY STATUS RED | MAKE READY | Soldier assumes a STANDING UNSUPPORTED firing position and loads one magazine or belt of ammunition. | |
| ALERT | CONTACT | | |
| TARGET DESCRIPTION | TROOPS | | |
| DIRECTION | FRONT | | |
| RANGE | MID-RANGE | | |
| METHOD | NEAR TO FAR | | |
| CONTROL | WEAPONS FREE WEAPONS FREE | Soldier moves the weapon from SAFE to FIRE, and begins the target acquisition process. | |
| EXECUTION | ENGAGE UPON POSITIVE IDENTIFICATION | Soldier engages the first target from the STANDING UNSUPPORTED firing position then goes to the PRONE UNSUPPORTED firing position. Soldier acquires, prioritizes, and engages targets with one round or killing burst per target. | |
| TOWER AWAITS COMPLETION OF ENGAGEMENT 5 THEN PROCEEDS IMMEDIATELY | | | |
| WEAPONS SAFETY STATUS REMAINS RED | | | |
| <p>Note: There is a 5-second delay between the first and second engagement to allow the Soldier to go to prone. There is a 3-second delay between all other engagements in this table. There is a 10-second delay at the end of the phase to support changing ammunition and changing the firing position.</p> | | | |
| <p>Legend: DODIC – Department of Defense identification code, MAG – magazine</p> | | | |

Table I-61. Table VI, engagement 6 through 10, conduct of fire example

| <i>Engagement 6 through 10 – Prone, Supported</i> | | | |
|---|---|--|-----------------------|
| | Engagement | Target | Target Type |
| | 6 through 10 | E-1 | Point |
| | Rounds | DODIC | Time (Seconds) |
| | 1 MAG x 10 1 BELT x 50 | AB57 AB73 | 63 |
| TOWER | | SOLDIER ACTION | |
| WEAPONS SAFETY STATUS RED | <i>Although the firer's bolt should be locked to the rear, the tower must treat all weapons as if in a RED status</i> | Soldier remains in the PRONE position, at the READY and may RELOAD or await instructions. | |
| CONTROL | GO TO PRONE SUPPORTED RELOAD | The Soldier conducts an emergency RELOAD and establishes a PRONE, SUPPORTED position and prepares to engage. | |
| TOWER AWAITS THE END OF THE 10-SECOND TRANSITION THEN PROCEEDS | | | |
| WEAPONS SAFETY STATUS REMAINS RED | | | |
| EXECUTION | ENGAGE UPON POSITIVE IDENTIFICATION | Soldier acquires, prioritizes, and engages targets with one round or killing burst per target. | |
| TOWER AWAITS COMPLETION OF ENGAGEMENT 10 THEN PROCEEDS IMMEDIATELY | | | |
| WEAPONS SAFETY STATUS REMAINS RED | | | |
| Note: There is a 3-second delay between all engagements. There is a 10-second delay at the end of the phase to support changing ammunition and changing the firing position. | | | |
| Legend: DODIC – Department of Defense identification code, MAG – magazine | | | |

Table I-62. Table VI, engagement 11 through 14, conduct of fire example

| <i>Engagement 11 through 14 – Kneeling, Supported</i> | | | |
|---|--|--|-----------------------|
| | Engagement | Target | Target Type |
| | 11 through 14 | E-1 F-1 | Point |
| | Rounds | DODIC | Time (Seconds) |
| | 1 MAG x 10 1 BELT x 50 | AB57 AB73 | 59 |
| TOWER | | SOLDIER ACTION | |
| WEAPONS SAFETY STATUS RED | <i>Although the firer's bolt should be locked to the rear, the tower must treat all weapons as if in a RED status.</i> | Soldier remains at the READY and may RELOAD or await instructions. | |
| CONTROL | RELOAD FIGHT UP | The Soldier conducts an emergency RELOAD and assumes the KNEELING, SUPPORTED position. | |
| TOWER AWAITS THE END OF THE 10-SECOND TRANSITION THEN PROCEEDS | | | |
| WEAPONS SAFETY STATUS REMAINS RED | | | |
| EXECUTION | ENGAGE UPON POSITIVE IDENTIFICATION | Soldier acquires, prioritizes, and engages targets with one round or killing burst per target. | |
| TOWER AWAITS COMPLETION OF ENGAGEMENT 14 THEN PROCEEDS | | | |
| WEAPONS SAFETY STATUS REMAINS RED | | | |
| Note: There is a 3-second delay between all engagements. There is a 10-second delay at the end of the phase to support changing ammunition and changing the firing position. | | | |
| Legend: AR – automatic rifle, DODIC – Department of Defense identification code, MAG – magazine | | | |

Table I-63. Table VI, engagement 15 through 18, conduct of fire example

| <i>Engagement 15 through 18 – Standing, Supported</i> | | | |
|--|--|--|-----------------------|
| | Engagement | Target | Target Type |
| | 15 through 18 | E-1 F-1 | Point |
| | Rounds | DODIC | Time (Seconds) |
| | 1 MAG x 10 1 BELT x 50 | AB57 AB73 | 109 |
| TOWER | | SOLDIER ACTION | |
| WEAPONS SAFETY STATUS RED | <i>Although the firer's bolt should be locked to the rear, the tower must treat all weapons as if in a RED status.</i> | Soldier remains at the READY and may RELOAD or await instructions. | |
| CONTROL | RELOAD FIGHT UP | The Soldier conducts an emergency RELOAD and assumes the STANDING, SUPPORTED position. | |
| TOWER AWAITS THE END OF THE 10-SECOND TRANSITION THEN PROCEEDS | | | |
| WEAPONS SAFETY STATUS REMAINS RED | | | |
| EXECUTION | ENGAGE UPON POSITIVE IDENTIFICATION | Soldier acquires, prioritizes, and engages targets with one round per target. | |
| TOWER AWAITS COMPLETION OF ENGAGEMENT 18 THEN PROCEEDS | | | |
| WEAPONS SAFETY STATUS REMAINS RED | | | |
| <p>Note: There is a 3-second delay between all engagements. There is a 60-second delay at the end of the phase to support the donning of protective equipment, M249 automatic rifle barrel change, and reloading.</p> <p>Legend: DODIC – Department of Defense identification code, MAG – magazine</p> | | | |

Table I-64. Table VI, stage 2, conduct of fire example









| Stage 2, Conduct of the Range | | | | |
|---|--|--|--|--|
|     CBRN | Engagement | Target | Target Type | |
| | Stage 2 | N/A | N/A | |
| | Rounds per Target | DODIC | Time (Seconds) | |
| | N/A | AB57 AB73 | 60 Seconds | |
| TOWER | | SOLDIER ACTION | | |
| CONDUCT OF THE RANGE CONTACT, CHEMICAL AGENTS HAVE BEEN REPORTED IN YOUR AREA GAS GAS GAS |     | Soldiers don their protective equipment. | | |
| ONCE ALL FIRERS HAVE COMPLETED DONNING PROTECTIVE GEAR, THE TOWER CONTINUES. | | | | |
| WEAPONS SAFETY STATUS RED | <i>Although the firer's bolt should be locked to the rear, the tower must treat all weapons as if in a RED status.</i> | | Soldier remains at the READY and may RELOAD or await instructions. | |
| CONTROL | BARREL CHANGE RELOAD | M249AR fires change barrels and all Soldiers conduct an emergency RELOAD and assumes the STANDING, SUPPORTED position. | | |
| TOWER AWAITS THE END OF THE 60-SECONDS THEN PROCEEDS | | | | |
| Legend: CBRN – chemical, biological, radiological, and nuclear, DODIC – Department of Defense identification code, N/A – not applicable | | | | |

Table I-65. Table VI, engagement 19 through 22, conduct of fire example

| <i>Engagement 19 through 22 – Standing, Supported</i> | | | |
|--|-------------------------------------|--|-----------------------|
| | Engagement | Target | Target Type |
| | 19 through 22 | E-1 F-1 | Point |
| | Rounds | DODIC | Time (Seconds) |
| | 1 MAG x 10 1 BELT x 50 | AB57 AB73 | 49 |
| TOWER | | SOLDIER ACTION | |
| WEAPONS SAFETY STATUS REMAINS RED | | | |
| CONTROL | CONTINUE TO FIGHT | Assumes the STANDING, SUPPORTED position. | |
| WEAPONS SAFETY STATUS REMAINS RED | | | |
| EXECUTION | ENGAGE UPON POSITIVE IDENTIFICATION | Soldier acquires, prioritizes, and engages targets with one round or killing burst per target. | |
| TOWER AWAITS COMPLETION OF ENGAGEMENT 22 THEN PROCEEDS | | | |
| WEAPONS SAFETY STATUS REMAINS RED | | | |
| Note: There is a 2-second delay between all engagements. There are no alibis authorized. Any remaining ammunition is returned to the ammunition issue point for redistribution. | | | |
| Legend: DODIC – Department of Defense identification code, MAG – magazine | | | |

I-95. A lane safety clears the firers upon their completion of Table VI and collecting their dunnage. A lane safety verifies the clearing prior to the Soldier moving from the firing point. Once the lane safety clears all the Soldiers, the lane safety communicates the WSS to the tower operator and the tower operator issues an administrative command moving the completed Soldiers off the range. Table I-66, on page I-76, is an example of this command.

Table I-66. Table VI, completed firing order, conduct of the range example

| Firing Order Complete | | | |
|--|--|--|----------------|
| | Task | Target | Target Type |
| FIRING ORDER COMPLETE | Completed Firing Order | N/A | N/A |
| | Rounds per Target | DODIC | Time (Seconds) |
| | N/A | N/A | NO LIMIT |
| TOWER | | SOLDIER ACTION | |
| TOWER MUST ASSUME ALL FIRERS' WEAPON SAFETY STATUS ARE RED | | | |
| TERMINATION | CEASE FIRE CEASE FIRE | Soldiers stop firing and place weapons on SAFE. | |
| WEAPONS SAFETY STATUS GREEN | GO GREEN GO GREEN | Soldiers clear their weapon and wait to be inspected by a lane safety. | |
| | ONCE VERIFIED BY THE RSO, SECURE WEAPON | | |
| CONDUCT OF THE RANGE | ALL CLEAR ALL CLEAR | Firers unmask, secure their weapon, ammunition, and dunnage. | |
| | SECURE YOUR DUNNAGE | Once complete, they move to the range's entry control point. | |
| | MOVE TO THE ENTRY CONTROL POINT | | |
| Once all firers return to the baseline, tower directs the firing order off the range. | | | |
| Legend: DODIC – Department of Defense identification code, N/A – not applicable, RSO – range safety officer | | | |

I-96. As soon as the lane safety clears the completed firing order, the tower operator moves a new firing order into position and the process repeats itself until all firers have successfully completed Table VI, Certification, training. The tower operator moves all identified firers that require retraining to the appropriate training location.

Glossary

The glossary lists acronyms and terms with Army or joint definitions. Where Army and joint definitions differ, (Army) precedes the definition. Terms for which TC 3-20.40 is the proponent are marked with an asterisk. The proponent manual for other terms is listed in parentheses after the definition.

SECTION I – ACRONYMS AND ABBREVIATIONS

| Acronym | Definition |
|----------------|---|
| AAR | after action review |
| AKO | Army Knowledge Online |
| AR | Army Regulation |
| ASP | ammunition supply point |
| AXP | ambulance exchange point |
| BCT | brigade combat team |
| CAC | common access card |
| CASEVAC | casualty evacuation |
| CATS | Combined Arms Training Strategy |
| CBRN | chemical, biological, radiological, and nuclear |
| CLS | combat lifesaver |
| DA | Department of the Army |
| DA PAM | Department of the Army pamphlet |
| DODIC | Department of Defense identification code |
| DTMS | Digital Training Management System |
| F | Fahrenheit |
| FM | field manual, frequency modulation |
| FRAGORD | fragmentary order |
| FY | fiscal year |
| GPS | Global Positioning System |
| IPR | in-progress review |
| MEDEVAC | medical evacuation |
| MIL STD | military standard |
| mm | millimeter |
| mph | miles per hour |
| MOPP | mission-oriented protective posture |
| MTOE | modified table of organization and equipment |
| NATO | North Atlantic Treaty Organization |
| NCO | noncommissioned officer |
| NCOIC | noncommissioned officer in charge |

| | |
|-----------------|---|
| NSN | national stock number |
| OIC | officer in charge |
| OPORD | operation order |
| RF | radio frequency |
| ROE | rules of engagement |
| S-3 | battalion or brigade operations staff officer |
| S-4 | battalion or brigade logistics staff officer |
| SME | subject matter expert |
| SOP | standard operating procedure |
| TB | technical bulletin |
| TC | training circular |
| TLP | troop leading procedure |
| TM | technical manual |
| TO&E | table of organization and equipment |
| UXO | unexploded explosive ordnance |
| WARNORD | warning order |

SECTION II – TERMS

This section contains no entries.

References

All URLs accessed 30 July 2019.

REQUIRED PUBLICATIONS

DOD Dictionary of Military and Associated Terms, May 2019.

ADP 1-02. *Terms and Military Symbols*, 14 August 2018.

RELATED PUBLICATIONS

Most Army doctrinal publications are available online: <https://armypubs.army.mil>

ARMY PUBLICATIONS

AR 5-13, *Total Army Munitions Requirements and Prioritization Policy*, 8 October 2015.

AR 75-1, *Malfunctions Involving Ammunition and Explosives*, 9 February 2017.

AR 220-1, *Army Unit Status Reporting and Force Registration – Consolidated Policies*, 15 April 2010.

AR 350-1, *Army Training and Leader Development*, 11 December 2017.

AR 385-10, *The Army Safety Program*, 24 February 2017.

AR 385-63/MCO 3570.1C, *Range Safety*, 30 January 2012.

AR 525-29, *Army Force Generation*, 14 March 2011.

AR 600-8-22, *Military Awards*, 5 March 2019.

ATP 3-21.8, *Infantry Platoon and Squad*, 12 April 2016.

ATP 3-21.18, *Foot Marches*, 17 April 2017.

ATP 4-32, *Explosive Ordnance Disposal (EOD) Operations*. 30 September 2013.

DA PAM 350-38, *Standards in Weapons Training*. 28 September 2018.

DA PAM 385-63, *Range Safety*, 16 April 2014.

DA PAM 385-64, *Ammunition and Explosives Safety Standards*, 24 May 2011.

FM 7-0, *Train To Win In A Complex World*, 5 October 2016.

FM 27-10, *The Law of Land Warfare*, 18 July 1956.

GTA 07-01-034, *M68 and M150 25-Meter Point of Impact Offsets*, 1 January 2019.

TB 9-1300-385, *Munitions Restricted or Suspended*, 31 July 2006.

TC 3-20.0, *Integrated Weapons Training Strategy (IWTS)*, 18 Jun 2019.

TC 3-20.31-4, *Direct Fire Engagement Process (DIDEA)*, 23 July 2015.

TC 3-22.9, *Rifle and Carbine*, 13 May 2016.

TC 3-22.10, *Sniper*, 7 December 2017.

TC 3-22.12, *M26 Modular Accessory Shotgun System*, 12 November 2014.

TC 3-22.19, *Grenade Machine Gun MK 19 MOD 3*, 10 May 2017.

TC 3-22.37, *Javelin – Close Combat Missile System, Medium*, 13 August 2013.

TC 3-22.50, *Heavy Machine Gun M2 Series*, 19 May 2017.

TC 3-22.240, *Medium Machine Gun*, 28 April 2017.

TC 3-22.249, *Light Machine Gun M249 Series*, 16 May 2017.

TC 3-23.30, *Grenades and Pyrotechnic Signals*, 22 November 2013.

References

- TC 3-23.35, *Pistol*, 30 May 2017.
- TC 25-8, *Training Ranges*, 22 July 2016.
- TM 3-22.31, *40-mm Grenade Launchers*, 17 November 2010.
- TM 3-23.25, *Shoulder-Launched Munitions*, 15 September 2010.
- TM 9-1005-201-10, *OPERATOR MANUAL FOR MACHINE GUN, 5.56MM, M249 W/EQUIP (NSN 1005-01-127-7510) (EIC: 4BG) (AR ROLE) (NSN 1005-01-451-6769) (EIC: 4BK) (LMG ROLE)*, 31 May 2019.
- TM 9-1005-239-10, *OPERATOR'S MANUAL LONG RANGE SNIPER RIFLE (LRSR), CALIBER .50, M107 (NSN 1005-01-469-2133)*, 30 November 2010.
- TM 9-1005-317-10, *OPERATOR MANUAL PISTOL, SEMIAUTOMATIC, 9MM, M9 (1005-01-118-2640) (EIC: 4MN) PISTOL, SEMIAUTOMATIC, 9MM, M9A1 (1005-01-525-7966) PISTOL, SEMIAUTOMATIC, 9MM, GO PISTOL (1005-01-588-5964) AIR FORCE ONLY GO PISTOL (1005-01-480-1274)*, 20 June 2016.
- TM 9-1005-319-10, *OPERATOR'S MANUAL FOR RIFLE, 5.56 MM, M16A2 (NSN 1005-01-128-9936), (EIC: 4GM) RIFLE, 5.56 MM, M16A3 (NSN 1005-01-357-5112) RIFLE, 5.56 MM, M16A4 (NSN 1005-01-383-2872) (EIC: 4F9) CARBINE, 5.56 MM, M4 (NSN 1005-01-231-0973) (EIC: 4FJ) CARBINE, 5.56 MM, M4A1 (NSN 1005-01-382-0953) (EIC: 4GC)*, 1 August 2016.
- TM 9-1005-325-10, *OPERATOR'S MANUAL FOR PISTOL, COMPACT, 9MM, M11 (NSN 1005-01-336-8265) PISTOL, COMPACT, 9MM, M11 WITH TRITIUM SIGHTS (1015-01-340-0096) {TO 11W3-3-4-11; SW 370-AG-OPI-010/9MM M11} (THIS ITEM IS INCLUDE ON EM 0065)*, 6 September 2011.
- TM 9-1005-342-10, *OPERATOR MANUAL FOR M110 SEMI-AUTOMATIC SNIPER SYSTEM (SASS), 7.62MM NSN 1005-01-534-2841 (EIC 4FZ)*, 30 September 2017.
- TM 9-1005-438-13&P, *TECHNICAL MANUAL OPERATOR AND FIELD MAINTENANCE MANUAL FOR RIFLE, .300 WIN MAG: SNIPER WITH DAY OPTICAL SIGHT AND CARRYING CASES, M2010 (NSN 1005-01-588-2913) P/N13030066 (THIS ITEM IS INCLUDED ON EM 0065)*, 3 June 2013.
- TM 9-1005-470-10, *OPERATOR MANUAL FOR MODULAR HANDGUN SYSTEM (MHS) PISTOL, 9MM, SEMIAUTOMATIC M17 (NSN 1005-01-661-7317) (EIC 2VN) PISTOL, 9MM, SEMIAUTOMATIC M18 (NSN 1005-01-661-7323) (EIC 2VP) PISTOL, 9MM, SEMIAUTOMATIC GO (NSN 1005-01-661-7309) (EIC 2VO)*, 31 March 2019.
- TM 9-1305-201-20&P, *UNIT MAINTENANCE MANUAL (INCLUDING REPAIR PARTS AND SPECIAL TOOLS LIST) FOR SMALL ARMS AMMUNITION TO 30 MILLIMETER INCLUSIVE (FEDERAL SUPPLY CLASS 1305) (REPRINTED W/BASIC INCL C1-20) (THIS ITEM IS INCLUDED ON EM 0162)*, 5 October 1981.

OTHER PUBLICATIONS

Most publications are available online: <https://assist.dla.mil/online/start/index.cfm>

MIL-STD are available online: <https://www.dla.mil/>

DOD publications are available online: <https://www.esd.whs.mil/Directives/issuances/dodd/>

Ammunition Book Complete (also known as Yellow Book), <http://www.dactces.org/index.php>

DOD 6055.9-STD, *DOD Ammunition and Explosives Safety Standards*. <https://www.dtic.mil>

Military-Handbook (MIL-HDBK) 1461A, *Ammunition Manufacturers and their Symbols*.

MIL-STD 709D, *Ammunition Color Coding*.

MIL-STD 1168C, *Ammunition Lot Numbering and Ammunition Data Card*, 11 March 2014.

Range Facility Management Support System 3.3.8 User Manual:

<https://rtvs.rfmss.army.mil/RTVS/Help/home/um.pdf>.

PRESCRIBED FORMS

Unless otherwise indicated, DA forms are available on the Army Publishing Directorate (APD) website: <https://armypubs.army.mil>.

DA Form 7489, *Night Fire, Assisted, Rifle Marksmanship Scorecard*.

DA Form 7801, *Rifle, Carbine, and Automatic Rifle Marksmanship Scorecard*.

DA Form 7811, *Sniper Scorecard*.

DA Form 7814, *Pistol Scorecard*.

DA Form 7815, *Weapons Training Roll Up*.

DA Form 7819, *Urban Marksmanship Scorecard*.

DA Form 7821, *Pistol Validation Scorecard*.

DA Form 7822, *Rifle and Carbine Validation Scorecard*.

REFERENCED FORMS

Unless otherwise indicated, DA forms are available on the Army Publishing Directorate (APD) website: <http://armypubs.army.mil>. DD forms are available on the Executive Services Directorate (ESD) website: <http://www.esd.whs.mil/Directives/forms/>.

DA Form 581, *Request for Issue and Turn-In of Ammunition*.

DA Form 2028, *Recommended Changes to Publications and Blank Forms*.

DA Form 2408-4, *Weapon Record Data*.

DA Form 3020-R, *Magazine Data Card*.

DA Form 3151-R, *Ammunition Stores Slip*.

DA Form 5515, *Training Ammunition Control Document*.

DA Form 5517, *Standard Range Card*.

DA Form 7636, *Sniper Target Data Sheet Moving Target*.

DA Form 7637, *Sniper's Range Card*.

DA Form 7638, *Military Sketch Panoramic and Topographic Views*.

DA Form 7651, *Sniper Target Data Sheet Stationary Target*.

DD Form 1575, *Suspended Tag – Materiel*. (Available through normal supply channels.)

DD Form 2977, *Deliberate Risk Assessment Worksheet*.

WEBSITES

Ammunition Information Notice 033-18, *Unit Level Delinking/Linking of Small Arms Ammunition*
<https://srp2.army.mil/RangeOperations/RangeSafety/Active%20ARSMMs/Forms/AllItems.aspx>

Army Knowledge Online (AKO) <https://www.ako1.us.army.mil/>

Army Training Network <https://atn.army.mil/>

Defense Ammunition Center <http://www.dactces.org/index.php>

Total Ammunition Management Information System (TAMIS)
<https://tamis.army.mil/Training/DownloadCBT.aspx>

Range Facility Management Support System:

<https://rtvs.rfmss.army.mil/RTVS/Pages/Visibility/VisibilityLogin.aspx>

Suspended or restricted ammunition <http://www.jmc.army.mil>

This page intentionally left blank.

Index

Entries are by paragraph number.

I
IPR, 2-15, 2-19, 2-20, 2-108,
2-90, 2-90, 2-36
IWTS, 1-1

L
live-fire, 2-4, 2-24, 2-25, 2-27,
2-141, 2-136, 2-135, 2-134,
2-130, 2-128, 2-118, 2-117,
2-115, 2-113, 2-107, 2-106,
2-101, 2-99, 2-97, 2-93,
2-92, 2-91, 2-78, 2-54, 2-36,
2-11, 2-6, 2-6, 2-6, 2-6, 2-6,
2-6, 2-6, 2-6, 2-6, 2-6, 2-6,
2-6, 1-8, 1-4, 1-2

M
maneuver box. 3-44
master gunner. 2-2

master gunner/
noncommissioned officer in
charge duties (in planning
training). 2-5
MATs. 3-28
MMT, 2-1

R
range
considerations. 3-2
personnel responsibilities.
4-85
reconnaissance. 4-17
range SOP. 4-21
responsibilities
during training. 4-24

S
stabilized platform
gunnery, 3-1

strategy principles
nine. 1-2
subject matter expert. 2-6, 2-4

T
targetry. 3-17

U
unit training plan. 2-7
unit training SME, 2-1, 2-25,
2-141, 2-139, 2-138, 2-137,
2-136, 2-135, 2-135, 2-133,
2-132, 2-132, 2-132, 2-131,
2-125, 2-124, 2-123, 2-122,
2-121, 2-118, 2-117, 2-116,
2-112, 2-111, 2-110, 2-107,
2-106, 2-100, 2-99, 2-94,
2-93, 2-90, 2-79, 2-68, 2-54,
2-39, 2-4, 2-3

This page intentionally left blank.

TC 3-20.40
30 July 2019

By Order of the Secretary of the Army:

MARK A. MILLEY
General, United States Army
Chief of Staff

Official:



KATHLEEN S. MILLER
Administrative Assistant
to the Secretary of the Army
1918414

DISTRIBUTION:

Active Army, Army National Guard, and United States Army Reserve: To be distributed in accordance with the initial distribution number (IDN) 116093, requirements for TC 3-20.40.

This page intentionally left blank.

This page intentionally left blank.

This page intentionally left blank.

